

YASKAWA

GA800 Drive

AC Drive for Industrial Applications Technical Reference

Catalog Code: **GA80Uxxxxxxx**
240 V class: 1 to 150 HP
480 V class: 1 to 600 HP

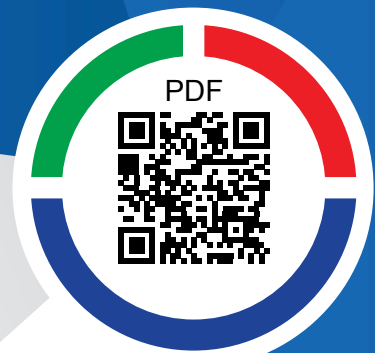

GET IT ON
Google Play

Download on the
App Store

Get the
DriveWizard® Mobile
Commissioning App

<https://www.yaskawa.com/dwm>

This Page Intentionally Blank

Table of Contents

i.	Preface and General Precautions	13
i.1	Receiving	14
	Glossary	14
	About Registered Trademarks	14
i.2	Using the Product Safely	15
	Explanation of Signal Words	15
	General Safety	15
	Warning Label Content and Location	17
	Cybersecurity	17
i.3	Warranty Information	19
	Exclusion of Liability	19
1.	Receiving	21
1.1	Section Safety	22
1.2	Catalog Code and Nameplate Check	23
	Nameplate	23
	How to Read the Catalog Code	23
1.3	Features and Advantages of Control Methods	26
2.	Mechanical Installation	31
2.1	Section Safety	32
2.2	Installation Environment	34
2.3	Installation Position and Distance	35
2.4	Moving the Drive	37
	Using the Hanging Brackets to Move the Drive	37
	Instructions on Drive Suspension	37
2.5	Remove and Reattach the Keypad	39
	Remove the Keypad	39
	Reattach the Keypad	39
2.6	Install the Keypad in a Control Panel or Another Device	40
	Operate the Keypad from a Remote Location	40
	Connect the Keypad from a Remote Location	40
2.7	Removing/Reattaching Covers	46
	Removing/Reattaching the Cover Using Procedure A	46
	Removing/Reattaching the Cover Using Procedure B	47
2.8	Change the Drive Enclosure Type	51
2.9	Installation Methods	52
	Standard Installation	52

External Heatsink Installation	52
3. Electrical Installation	59
3.1 Section Safety	60
3.2 Electrical Installation	62
Standard Connection Diagram	62
3.3 Main Circuit Wiring	65
Motor and Main Circuit Connections	65
Configuration of Main Circuit Terminal Block	65
Main Circuit Terminal Functions	71
Wire Selection	71
Main Circuit Terminal and Motor Wiring	82
Protection of Main Circuit Terminals	85
3.4 Main Circuit Terminal Block Wiring Procedure	86
Wire the Main Circuit Terminal Block with Procedure A	86
Wire the Main Circuit Terminal Block with Procedure B	90
3.5 Control Circuit Wiring	92
Control Circuit Connection Diagram	92
Control Circuit Terminal Block Functions	93
Control Circuit Terminal Configuration	96
Wiring the Control Circuit Terminal	98
Switches and Jumpers on the Terminal Board	101
3.6 Control I/O Connections	102
Set Sinking Mode/Sourcing Mode	102
Pulse Train Output	102
Set Input Signals for MFAI Terminals A1 to A3	103
Set MFAI Terminal A3 to PTC Input	104
Set Output Signals for MFAO Terminals FM, AM	104
Switch ON Termination Resistor for MEMOBUS/Modbus Communications	105
3.7 Connect the Drive to a PC	106
3.8 External Interlock	107
3.9 Braking Resistor Installation	108
Install a Braking Resistor: ERF-Type	108
Install a Braking Resistor Unit: LKEB-Type	108
Install a Braking Unit Connection: CDBR-Type	109
Connect Braking Units in Parallel	115
Dynamic Braking Option Overload Protection	116
3.10 Drive Wiring Protection	117
Installing a Ground Fault Circuit Interrupter (GFCI)	117
Installing a Molded-Case Circuit Breaker (MCCB) or Ground Fault Circuit Interrupter (GFCI)	117
3.11 Dynamic Braking Option, Motor Protection	118
Install an Electromagnetic Contactor (MC) at the Input Side of the Drive	118
Installing a Thermal Overload Relay on the Drive Output	118
3.12 Improve the Power Factor	120
Connect an AC Reactor or a DC Link Choke	120
3.13 Prevent Switching Surge	121
3.14 Decrease Noise	122
Connect a Noise Filter to the Input Side (Primary Side)	122
Connect a Noise Filter to the Output Side (Secondary Side)	122
3.15 Branch Circuit Protection	124

	Factory-Recommended Branch Circuit Protection for UL Listing	124
3.16	External EMC Noise Filter Selection	126
3.17	Wiring Checklist	128
3.18	Motor Application Precautions	130
	Precautions for Existing Standard Motors	130
	Precautions for PM Motors	131
	Precautions for Specialized Motors	131
	Notes on the Power Transmission Mechanism	132
4.	Startup Procedure and Test Run	133
4.1	Section Safety	134
4.2	Keypad: Names and Functions	135
	LCD Display	137
	Indicator LEDs and Drive Status	138
	Keypad Mode and Menu Displays	139
4.3	LED Status Ring	141
4.4	Start-up Procedures	143
	Flowchart A: Connect and Run the Motor with Minimum Setting Changes	143
	Sub-Chart A-1: Induction Motor Auto-Tuning and Test Run Procedure	145
	Sub-Chart A-2: PM Motor Auto-Tuning and Test Run Procedure	146
	Subchart A-3: EZ Open Loop Vector Control Test Run Procedure	148
4.5	Items to Check before Starting Up the Drive	149
	Check before Energizing the Drive	149
	Check after Energizing the Drive	149
	Make the Initial Settings	150
4.6	Keypad Operation	151
	Home Screen Display Selection	151
	Showing the Monitor	152
	Set Custom Monitors	153
	Show Custom Monitors	154
	Set the Monitors to Show as a Bar Graph	155
	Show Monitors as Bar Graphs	156
	Set the Monitors to Show as Analog Gauges	157
	Display Monitors as an Analog Gauge	158
	Set Monitoring Items to be Shown as a Trend Plot	158
	Show Monitor Items as a Trend Plot	162
	Change Parameter Setting Values	163
	Examine User Custom Parameters	164
	Save a Backup of Parameters	166
	Write Backed-up Parameters to the Drive	167
	Verify Keypad Parameters and Drive Parameters	168
	Delete Parameters Backed Up to the Keypad	169
	Check Modified Parameters	170
	Restore Modified Parameters to Defaults	172
	Show Fault History	173
	Auto-Tuning the Drive	174
	Set the Keypad Language Display	176
	Set the Date and Time	177
	Set Parameters Using the Setup Wizard	179
	Disable the Initial Setup Screen	181
	Start Data Logging	182
	Configuring the Data Log Content	183
	Set Backlight to Automatically Turn OFF	185

	Show Information about the Drive	186
	Write Automatically Backed-up Parameters to the Drive	187
4.7	Automatic Parameter Settings Optimized for Specific Applications (Application Presets)	189
4.8	Auto-Tuning	191
	Auto-Tuning for Induction Motors	191
	Auto-Tuning for Motor Parameters for PM Motor	192
	Auto-Tuning in EZ Open Loop Vector Control Method	194
	Control Tuning	195
	Precautions before Auto-Tuning	197
4.9	Test Run	200
	No-Load Test Run	200
	Do a No-Load Test Run	200
	Actual-Load Test Run	200
	Do an Actual-Load Test Run	201
4.10	Fine Tuning during Test Runs (Adjust the Control Function)	202
	V/f Control and Closed Loop V/f Control	202
	Open Loop Vector Control Method	203
	Closed Loop Vector Control Method	204
	Advanced Open Loop Vector Control Method	205
	Fine-Tuning Open Loop Vector Control for PM Motors	206
	Advanced Open Loop Vector Control Method for PM	207
	Closed Loop Vector Control Method for PM	207
	EZ Open Loop Vector Control Method	208
4.11	Test Run Checklist	209
5.	Standards Compliance	211
5.1	Section Safety	212
5.2	European Standards	214
	EU Declaration of Conformity	214
	CE Low Voltage Directive Compliance	214
	EMC Directive	230
5.3	UL Standards	235
	Area of Use	235
	Wire the Main Circuit Terminal Block	235
	UL Standards Compliance for DC Power Supply Input	251
	Low Voltage Wiring for Control Circuit Terminals	253
	Drive Motor Overload and Overheat Protection	253
5.4	对应中国RoHS指令	259
	本产品中含有有害物质的信息	259
5.5	China RoHS Compliance	260
	Information on Hazardous Substances in This Product	260
5.6	Safe Disable Input	261
	Safe Disable Specifications	261
	Notes	262
	Using the Safe Disable Function	262
6.	Network Communications	269
6.1	Section Safety	270
6.2	Field Bus Network Support	271
6.3	MEMOBUS/Modbus Communications	272

Configure Master/Slave	272
Communication Specifications	272
Communication with the PLC	272
MEMOBUS/Modbus Drive Operations	274
Communications Timing	274
Message Format	275
Examples of Messages for Commands/Responses	277
Enter Command	282
Self-Diagnostics	283
Communications Data Table	283
Error Codes	304
7. Troubleshooting	307
7.1 Section Safety	308
7.2 Types of Faults, Minor Faults, Alarms, and Errors	310
7.3 List of Fault, Minor Fault, Alarm, and Error Codes	311
7.4 Fault	317
7.5 Minor Faults/Alarms	337
7.6 Parameter Setting Errors	347
7.7 Auto-Tuning Errors	353
7.8 Backup Function Operating Mode Display and Errors	358
7.9 Diagnosing and Resetting Faults	360
Fault Occurs Without Power Loss	360
Fault Occurs Without Power Loss	360
Fault Reset	360
7.10 Troubleshooting Without Fault Display	362
Typical Problems	362
The Parameter Settings Will Not Change	362
The Motor Does Not Rotate After Entering Run Command	363
The Motor Rotates in the Opposite Direction from the Run Command	364
The Motor Rotates in Only One Direction	364
The Motor Is Too Hot	364
The Correct Auto-Tuning Mode Is Not Available	365
The Motor Stalls during Acceleration or Accel/Decel Time Is Too Long	365
The Drive Frequency Reference Is Different than the Controller Frequency Reference Command	366
The Motor Speed Is Not Stable When Using a PM Motor	366
There Is Too Much Motor Oscillation and the Rotation Is Irregular	366
Deceleration Takes Longer Than Expected When Dynamic Braking Is Enabled	366
There Is Audible Noise from the Drive or Motor Cables When the Drive Is Energized	367
The Ground Fault Circuit Interrupter (GFCI) Trips During Run	367
Motor Rotation Causes Unexpected Audible Noise from Connected Machinery	367
Motor Rotation Causes Oscillation or Hunting	367
PID Output Fault	368
The Starting Torque Is Not Sufficient	368
The Motor Rotates after the Drive Output Is Shut Off	368
The Output Frequency Is Lower Than the Frequency Reference	368
The Motor Is Making an Audible Noise	369
The Motor Will Not Restart after a Loss of Power	369
8. Periodic Inspection and Maintenance	371
8.1 Section Safety	372
8.2 Inspection	374

	Recommended Daily Inspection	374
	Recommended Periodic Inspection	374
8.3	Maintenance	377
8.4	Replace Cooling Fans and Circulation Fans	380
	Cooling Fans and Circulation Fans by Drive Model	380
	Replace a Fan (Procedure A)	380
	Replace a Fan (Procedure B)	383
	Replace a Fan (Procedure C)	385
	Replace a Fan (Procedure D)	388
	Replace a Fan (Procedure E)	390
	Replace Fans (Procedure F)	393
	Replace Fans (Procedure G)	400
	Replace Fans (Procedure H)	409
8.5	Replace the Drive	417
	About the Control Circuit Terminal Block	417
	Replace the Drive	417
8.6	Replace the Keypad Battery	423
8.7	Storage Guidelines	425
9.	Disposal	427
9.1	Section Safety	428
9.2	Disposal Instructions	429
9.3	WEEE Directive	430
10.	Specifications	431
10.1	Section Safety	432
10.2	Drive Duty Modes	433
10.3	Model-Specific Specifications (200 V Class)	434
10.4	Model-Specific Specifications (400 V Class)	436
10.5	Common Drive Specifications	439
10.6	Drive Watt Loss	443
10.7	Drive Derating	446
	Carrier Frequency Settings and Rated Current Values	446
	Derating Depending on Ambient Temperature	450
	Altitude Derating	451
10.8	Drive Exterior and Mounting Dimensions	452
	Drive Models and Exterior/Mounting Dimensions	452
	IP20/UL Open Type	453
	IP20/UL Type 1	463
10.9	Knock-Out Hole Dimensions (IP20/UL Type 1)	473
	Models and Dimensions of Knock-Out Hole	473
10.10	Peripheral Devices and Options	478
11.	Parameter List	479
11.1	Section Safety	480
11.2	How to Read the Parameter List	481
	Icons and Terms that Identify Parameters and Control Methods	481
11.3	Parameter Groups	482
11.4	A: Initialization Parameters	484

	A1: Initialization	484
	A2: User Parameters	485
11.5	b: Application	486
	b1: Operation Mode Selection	486
	b2: DC Injection Braking and Short Circuit Braking	487
	b3: Speed Search	488
	b4: Timer Function	490
	b5: PID Control	491
	b6: Dwell Function	494
	b7: Droop Control	495
	b8: Energy Saving	495
	b9: Zero Servo	496
11.6	C: Tuning	497
	C1: Accel & Decel Time	497
	C2: S-Curve Characteristics	497
	C3: Slip Compensation	498
	C4: Torque Compensation	499
	C5: Auto Speed Regulator (ASR)	500
	C6: Duty & Carrier Frequency	502
11.7	d: Reference Settings	503
	d1: Frequency Reference	503
	d2: Reference Limits	504
	d3: Jump Frequency	505
	d4: Frequency Ref Up/Down & Hold	505
	d5: Torque Control	506
	d6: Field Weakening /Forcing	506
	d7: Offset Frequency	507
11.8	E: Motor Parameters	508
	E1: V/f Pattern for Motor 1	508
	E2: Motor Parameters	509
	E3: V/f Pattern for Motor 2	510
	E4: Motor 2 Parameters	510
	E5: PM Motor Settings	511
	E9: Motor Setting	512
11.9	F: Options	513
	F1: Encoder Option Setup	513
	F2: Analog Input Option	515
	F3: Digital Input Option	516
	F4: Analog Output Option	517
	F5: Digital Output Option	517
	F6: Communication Options	518
	F7: Ethernet Options	522
11.10	H: Terminal Functions	526
	H1: Digital Inputs	526
	H2: Digital Outputs	531
	H3: Analog Inputs	538
	H4: Analog Outputs	541
	H5: Modbus Communication	542
	H6: Pulse Train Input/Output	543
	H7: Virtual MFIO selection	544
11.11	L: Protection Functions	546
	L1: Motor Protection	546
	L2: Power Loss Ride Through	547

L3: Stall Prevention	548
L4: Speed Detection	550
L5: Fault Restart	550
L6: Torque Detection	552
L7: Torque Limit	553
L8: Drive Protection	553
L9: Drive Protection 2	556
11.12 n: Special Adjustment	557
n1: Hunting Prevention	557
n2: Auto Freq Regulator (AFR)	558
n3: High Slip/Overexcite Braking	558
n4: Adv Open Loop Vector Tune	559
n5: Feed Forward Control	560
n6: Online Tuning	560
n7: EZ Drive	560
n8: PM Motor Control Tuning	561
11.13 o: Keypad-Related Settings	565
o1: Keypad Display	565
o2: Keypad Operation	567
o3: Copy Keypad Function	568
o4: Maintenance Monitors	569
o5: Log Function	569
11.14 q: DriveWorksEZ Parameters	571
q1-01 to q8-40: Reserved for DriveWorksEZ	571
11.15 r: DWEZ Connection 1-20	572
r1-01 to r1-40: DriveWorksEZ Connection Parameters 1 to 20 (Upper / Lower)	572
11.16 T: Motor Tuning	573
T0: Tuning Mode Selection	573
T1: Induction Motor Auto-Tuning	573
T2: PM Motor Auto-Tuning	574
T3: ASR and Inertia Tuning	575
T4: EZ Tuning	576
11.17 U: Monitors	577
U1: Operation Status Monitors	577
U2: Fault Trace	579
U3: Fault History	581
U4: Maintenance Monitors	582
U5: PID Monitors	586
U6: Operation Status Monitors	586
U8: DriveWorksEZ Monitors	589
11.18 Parameters that Change from the Default Settings with A1-02 [Control Method Selection]	590
11.19 Parameters that Change from the Default Settings with E3-01 [Motor 2 Control Mode Selection]	595
11.20 Parameters Changed by E1-03 [V/f Pattern Selection]	596
11.21 Defaults by Drive Model and Duty Rating ND/HD	598
200 V class	598
400 V Class	605
11.22 Parameters Changed by PM Motor Code Selection	616
Yaskawa SMRA Series SPM Motors	616
Yaskawa SSR1 Series IPM Motors (Derated Torque)	617
Yaskawa SST4 Series IPM Motors (Constant Torque)	627

12. Parameter Details	637
12.1 Section Safety	638
12.2 A: Initialization Parameters	639
A1: Initialization	639
A2: User Parameters	657
12.3 b: Application	658
b1: Operation Mode Selection	658
b2: DC Injection Braking and Short Circuit Braking	671
b3: Speed Search	674
b4: Timer Function	684
b5: PID Control	686
b6: Dwell Function	702
b7: Droop Control	703
b8: Energy Saving	704
b9: Zero Servo	709
12.4 C: Tuning	711
C1: Accel & Decel Time	711
C2: S-Curve Characteristics	716
C3: Slip Compensation	717
C4: Torque Compensation	722
C5: Auto Speed Regulator (ASR)	724
C6: Duty & Carrier Frequency	733
12.5 d: References	738
d1: Frequency Reference	738
d2: Reference Limits	744
d3: Jump Frequency	745
d4: Frequency Ref Up/Down & Hold	746
d5: Torque Control	751
d6: Field Weakening /Forcing	756
d7: Offset Frequency	757
12.6 E: Motor Parameters	759
E1: V/f Pattern for Motor 1	759
E2: Motor Parameters	767
E3: V/f Pattern for Motor 2	770
E4: Motor 2 Parameters	772
E5: PM Motor Settings	774
E9: Motor Setting	777
12.7 F: Options	780
F1: Encoder Option Setup	780
F2: Analog Input Option	788
F3: Digital Input Option	790
F4: Analog Monitor Option	794
F5: Digital Output Option	797
F6, F7: Communication Options and Ethernet Options	800
12.8 H: Terminal Functions	822
H1: Digital Inputs	822
Multi-Function Digital Input Setting Values	826
H2: Digital Outputs	846
H2 MFDO Parameters	848
MFDO Setting Value	855
H3: Analog Inputs	870
H3: MFAI Parameters	873
Multi-Function Analog Input Terminal Settings	878

	H4: Analog Outputs	884
	H5: Memobus/Modbus Communication	887
	H6: Pulse Train Input/Output	891
	H7: Virtual MFIO Selection	895
12.9	L: Protection Functions	900
	L1: Motor Protection	900
	L2: Power Loss Ride Through	906
	L3: Stall Prevention	917
	L4: Speed Detection	927
	L5: Fault Restart	928
	L6: Torque Detection	931
	L7: Torque Limit	937
	L8: Drive Protection	940
	L9: Drive Protection 2	948
12.10	n: Special Adjustment	949
	n1: Hunting Prevention	949
	n2: Auto Freq Regulator (AFR)	951
	n3: High Slip Braking (HSB) and Overexcitation Braking	952
	n4: Adv Open Loop Vector Tune	956
	n5: Feed Forward Control	959
	n6: Online Tuning	962
	n7: EZ Drive	963
	n8: PM Motor Control Tuning	964
12.11	o: Keypad-Related Settings	975
	o1: Keypad Display Selection	975
	o2: Keypad Operation	982
	o3: Copy Function	987
	o4: Maintenance Mon Settings	988
	o5: Log Function	991
12.12	T: Auto-Tuning	997
	T0: Tuning Mode Selection	997
	T1: Induction Motor Auto-Tuning	997
	T2: PM Motor Auto-Tuning	1000
	T3: ASR and Inertia Tuning	1003
	T4: EZ Tuning	1004
	Index	1006
	Revision History	1015

Preface and General Precautions

This chapter gives information about important safety precautions for the use of this product. Failure to obey these precautions can cause serious injury or death, or damage to the product or related devices and systems. Yaskawa must not be held responsible for any injury or equipment damage as a result of the failure to observe these precautions and instructions.

i.1	Receiving	14
i.2	Using the Product Safely	15
i.3	Warranty Information	19

i.1 Receiving

These instructions contain the information necessary to use the product correctly. Read and understand the safety information and precautions before you start to use the product.

◆ Glossary

Phrase	Definition
AOLV	Advanced Open Loop Vector Control
AOLV/PM	Advanced Open Loop Vector Control for Permanent Magnet Motors
CLV	Closed Loop Vector Control
CL-V/f	Closed Loop V/f Control
CLV/PM	Closed Loop Vector Control for Permanent Magnet Motors
Drive	YASKAWA AC Drive GA800
EDM	External Device Monitor
EZOLV	EZ Open Loop Vector Control
HD	Heavy Duty
IPM motor	Interior Permanent Magnet Motor
MFAI	Multi-Function Analog Input
MFAO	Multi-Function Analog Output
MFDI	Multi-Function Digital Input
MFDO	Multi-Function Digital Output
ND	Normal Duty
OLV	Open Loop Vector Control
OLV/PM	Open Loop Vector Control for Permanent Magnet Motors
PM motor	Permanent Magnet Synchronous motor (generic name for IPM motors and SPM motors)
SIL	Safety Integrity Level
SPM motor	Surface Permanent Magnet Motor
V/f	V/f Control

◆ About Registered Trademarks

- CANopen is a registered trademark of CAN in Automation (CIA).
- CC-Link is a registered trademark of CC-Link Partner Association.
- DeviceNet is a registered trademark of Open DeviceNet Vendor Association, Inc. (ODVA).
- EtherCAT is a registered trademark of Beckhoff Automation GmbH.
- EtherNet/IP is a registered trademark of Open DeviceNet Vendor Association, Inc. (ODVA).
- LonWorks and LonTalk are registered trademarks of Echelon Corporation.
- MECHATROLINK-I, MECHATROLINK-II, and MECHATROLINK-III are registered trademarks of MECHATROLINK Members Association (MMA).
- Modbus is a registered trademark of Schneider Electric SA.
- PROFIBUS-DP and PROFINET are registered trademarks of PROFIBUS International.
- Other company names and product names in this document are trademarks or registered trademarks of the respective companies.

i.2 Using the Product Safely

◆ Explanation of Signal Words

⚠ WARNING

Read and understand this manual before you install, operate, or do maintenance on the drive. Install the drive as specified by this manual and local codes.

The symbols in this section identify safety messages in this manual. If you do not obey these safety messages, the hazards can cause serious injury, death, or damage to the products and related equipment and systems.

These identifier words categorize and emphasize important safety precautions in these instructions.

⚠ DANGER

This signal word identifies a hazard that will cause serious injury or death if you do not prevent it.

⚠ WARNING

This signal word identifies a hazard that can cause death or serious injuries if you do not prevent it.

⚠ CAUTION

Identifies a hazardous situation, which, if not avoided, can cause minor or moderate injury.

NOTICE

This signal word identifies a property damage message that is not related to personal injury.

◆ General Safety

General Precautions

- Some figures in the instructions include options and drives without covers or safety shields to more clearly show the inside of the drive. Replace covers and shields before operation. Use options and drives only as specified by the instructions.
- The figures in this manual are examples only. All figures do not apply to all products included in this manual.
- Yaskawa can change the products, specifications, and content of the instructions without notice to make the product and/or the instructions better.
- If you damage or lose these instructions, contact a Yaskawa representative or the nearest Yaskawa sales office on the rear cover of the manual, and tell them the document number on the front cover to order new copies.

⚠ DANGER

Do not ignore the safety messages in this manual.

If you ignore the safety messages in this manual, it will cause serious injury or death. The manufacturer is not responsible for injuries or damage to equipment.

Electrical Shock Hazard

Do not examine, connect, or disconnect wiring on an energized drive. Before servicing, disconnect all power to the equipment and wait for the time specified on the warning label at a minimum. The internal capacitor stays charged after the drive is de-energized. The charge indicator LED extinguishes when the DC bus voltage decreases below 50 Vdc. When all indicators are OFF, remove the covers before measuring for dangerous voltages to make sure that the drive is safe.

If you do work on the drive when it is energized, it will cause serious injury or death from electrical shock. The drive has internal capacitors that stay charged after you de-energize the drive.

WARNING

Crush Hazard

Test the system to make sure that the drive operates safely after you wire the drive and set parameters.

If you do not test the system, it can cause damage to equipment or serious injury or death.

Sudden Movement Hazard

Before you do a test run, make sure that the setting values for virtual input and output function parameters are correct. Virtual input and output functions can have different default settings and operation than wired input and output functions.

Incorrect function settings can cause serious injury or death.

Remove all personnel and objects from the area around the drive, motor, and machine and attach covers, couplings, shaft keys, and machine loads before you energize the drive.

If personnel are too close or if there are missing parts, it can cause serious injury or death.

Examine the I/O signals and internal sequence with the engineer who made the DriveWorksEZ program before you operate the drive.

If you do not know how the drive will operate, it can cause serious injury or death. When you use DriveWorksEZ to make custom programming, the drive I/O terminal functions change from factory settings and the drive will not operate as written in this manual.

Electrical Shock Hazard

Do not modify the drive body or drive circuitry.

Modifications to drive body and circuitry can cause serious injury or death, will cause damage to the drive, and will void the warranty. Yaskawa is not responsible for modifications of the product made by the user.

Only let approved personnel install, wire, maintain, examine, replace parts, and repair the drive.

If personnel are not approved, it can cause serious injury or death.

Do not remove covers or touch circuit boards while the drive is energized.

If you touch the internal components of an energized drive, it can cause serious injury or death.

After the drive blows a fuse or trips a GFCI, do not immediately energize the drive or operate peripheral devices. Wait for the time specified on the warning label at a minimum and make sure that all indicators are OFF. Then check the wiring and peripheral device ratings to find the cause of the problem. If you do not know the cause of the problem, contact Yaskawa before you energize the drive or peripheral devices.

If you do not fix the problem before you operate the drive or peripheral devices, it can cause serious injury or death.

Damage to Equipment

Do not apply incorrect voltage to the main circuit of the drive. Operate the drive in the specified range of the input voltage on the drive nameplate.

Voltages that are higher than the permitted nameplate tolerance can cause damage to the drive.

Fire Hazard

Install sufficient branch circuit short circuit protection as specified by applicable codes and this manual. The drive is suitable for circuits that supply not more than 100,000 RMS symmetrical amperes, 240 Vac maximum (200 V Class), 480 Vac maximum (400 V Class).

Incorrect branch circuit short circuit protection can cause serious injury or death.

CAUTION

Crush Hazard

Tighten terminal cover screws and hold the case safely when you move the drive.

If the drive or covers fall, it can cause moderate injury.

NOTICE

Use an inverter-duty motor or vector-duty motor with reinforced insulation and windings applicable for use with an AC drive.

If the motor does not have the correct insulation, it can cause a short circuit or ground fault from insulation deterioration.

Damage to Equipment

When you touch the drive and circuit boards, make sure that you observe correct electrostatic discharge (ESD) procedures.

If you do not follow procedures, it can cause ESD damage to the drive circuitry.

Do not do a withstand voltage test or use a megohmmeter or megger insulation tester on the drive.

These tests can cause damage to the drive.

Do not operate a drive or connected equipment that has damaged or missing parts.

You can cause damage to the drive and connected equipment.

Do not use steam or other disinfectants to fumigate wood for packaging the drive. Use alternative methods, for example heat treatment, before you package the components.

Gas from wood packaging fumigated with halogen disinfectants, for example fluorine, chlorine, bromine, iodine or DOP gas (phthalic acid ester), can cause damage to the drive.

◆ Warning Label Content and Location

The drive warning label is in the location shown in [Figure i.1](#). Use the drive as specified by this information.

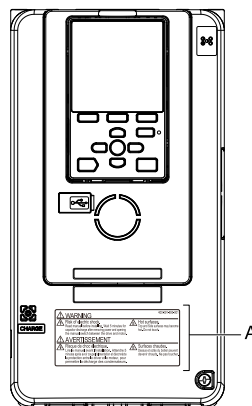
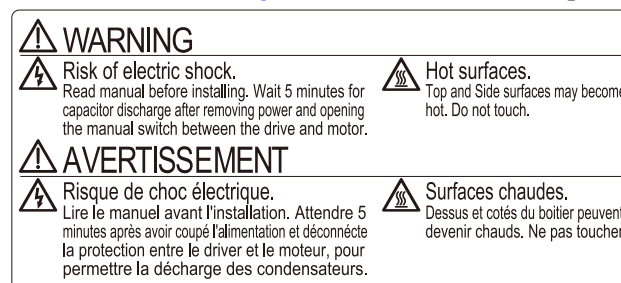

A - Warning label

Figure i.1 Warning Label Content and Location

◆ Cybersecurity

This product is designed to connect and communicate information and data through a network interface. It is the sole responsibility of the customer to provide and continuously guarantee a secure connection between the product and the

customer's network or if applicable, any other network. The customer must establish and maintain the appropriate measures (such as, but not limited to, the installation of firewalls, the application of authentication measures, the encryption of data, the installation of antivirus programs, etc.) to protect the product, the network, its system and the interface against all types of security breaches, unauthorized access, interference, intrusion, leakage and/or theft of data or information. Yaskawa and its affiliates are not responsible for damages and/or losses related to such security breaches, any unauthorized access, interference, intrusion, leakage and/or theft of data or information.

i.3 Warranty Information

◆ Exclusion of Liability

- This product is not designed and manufactured for use in life-support machines or systems.
- Contact a Yaskawa representative or your Yaskawa sales representative if you are considering the application of this product for special purposes, such as machines or systems used for passenger cars, medicine, airplanes and aerospace, nuclear power, electric power, or undersea relaying.

WARNING

Injury to Personnel

When you use this product in applications where its failure could cause the loss of human life, a serious accident, or physical injury, you must install applicable safety devices.

If you do not correctly install safety devices, it can cause serious injury or death.

Receiving

This chapter gives information about the different drive models and features, and how to examine the drive when you receive it.

1.1	Section Safety	22
1.2	Catalog Code and Nameplate Check.....	23
1.3	Features and Advantages of Control Methods	26

1.1 Section Safety

 **DANGER**

Do not ignore the safety messages in this manual.

If you ignore the safety messages in this manual, it will cause serious injury or death. The manufacturer is not responsible for injuries or damage to equipment.

1.2 Catalog Code and Nameplate Check

Please examine these items after you received the drive:

- Examine the drive for damage or missing parts. Immediately contact the shipping company if the drive is damaged. The Yaskawa warranty does not cover damage from shipping.
- Examine the catalog code in the “C/C” section of the drive nameplate to make sure that you received the correct model.
- If you received a product different than what you ordered or your product has a defect, contact Yaskawa or your nearest sales representative.

◆ Nameplate

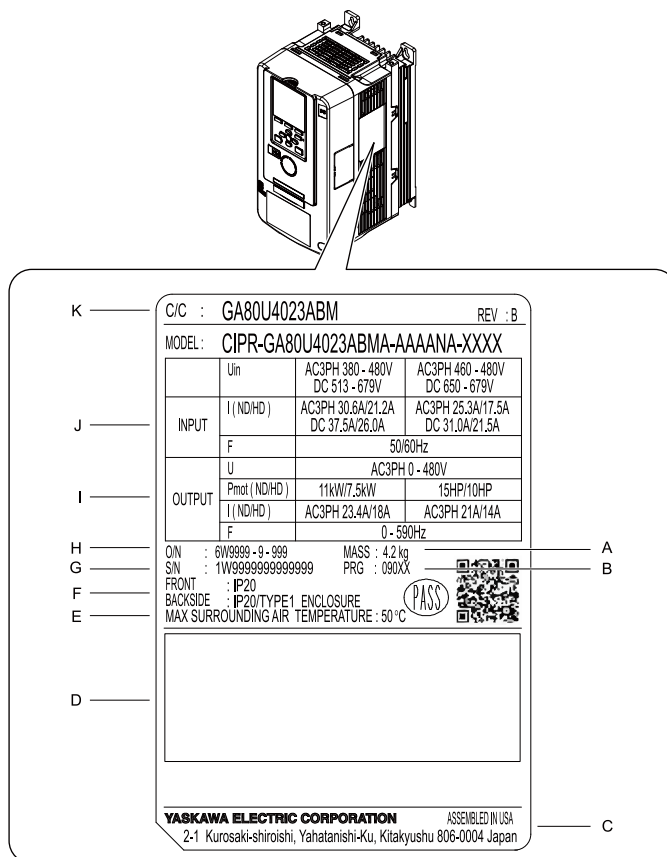

- | | |
|--|---------------------------|
| A - Product revision | G - Protection design |
| B - Weight | H - Product number |
| C - Drive software version | I - Serial number |
| D - The address of the head office of Yaskawa Electric Corporation | J - Output specifications |
| E - Accreditation standards | K - Input specifications |
| F - Ambient Temperature Setting | L - Catalog code |

Figure 1.1 Nameplate Location

◆ How to Read the Catalog Code

Use the information in [Figure 1.2](#) and [Table 1.1](#) to read the drive catalog codes.

GA80	U	4	023	A	W	M
1	2	3	4	5	6	7

Figure 1.2 Drive Catalog Code

1.2 Catalog Code and Nameplate Check

Table 1.1 Catalog Code Details

No.	Description
1	GA800 Series
2	Region code • U: Americas
3	Input power supply voltage • 2: Three-Phase AC 240 V • 4: Three-Phase AC 480 V
4	Rated output current Note: Refer to the rated output current list for more information.
5	EMC noise filter A: No built-in EMC filter
6	Protection design B: IP20/UL Open Type W: IP55/UL Type 12 Heatsink External Mounting
7	Environmental specification M: Resistant to dust/humidity

■ Rated Output Current

Refer to [Table 1.2](#) to [Table 1.3](#) for rated output current values.

Note:

- These output current values apply to drives that operate at standard specifications.
- Derate the output current for applications that require:
 - Higher carrier frequencies
 - Ambient temperature beyond nameplate ratings
 - Drives installed side-by-side.
- Use C6-01 [*Normal / Heavy Duty Selection*] to select Normal Duty rating (ND) or Heavy Duty rating (HD).

Table 1.2 Output Current for Three-Phase AC 240 V Models

Model	Heavy Duty Rating (HD) Parameter C6-01 = 0		Normal Duty Rating (ND) Parameter C6-01 = 1 (Default)	
	Maximum Motor Output kW (HP)	Rated Output Current A	Maximum Motor Output kW (HP)	Rated Output Current A
2004	0.55 (.75)	3.5	0.75 (1)	4.2
2006	0.75 (1)	5	1.1 (1.5)	6
2008	1.1 (1.5)	6.9	1.5 (2)	8
2010	1.5 (2)	8	2.2 (3)	9.6
2012	2.2 (3)	11	3 (4)	12.2
2018	3 (4)	14	3.7 (5)	17.5
2021	3.7 (5)	17.5	5.5 (7.5)	21
2030	5.5 (7.5)	25	7.5 (10)	30
2042	7.5 (10)	33	11 (15)	42
2056	11 (15)	47	15 (20)	56
2070	15 (20)	60	18.5 (25)	70
2082	18.5 (25)	75	22 (30)	82
2110	22 (30)	88	30 (40)	110
2138	30 (40)	115	37 (50)	138
2169	37 (50)	145	45 (60)	169
2211	45 (60)	180	55 (75)	211
2257	55 (75)	215	75 (100)	257

Model	Heavy Duty Rating (HD) Parameter C6-01 = 0		Normal Duty Rating (ND) Parameter C6-01 = 1 (Default)	
	Maximum Motor Output kW (HP)	Rated Output Current A	Maximum Motor Output kW (HP)	Rated Output Current A
2313	75 (100)	283	90 (125)	313
2360	90 (125)	346	110 (150)	360
2415	110 (150)	415	110 (150)	415

Table 1.3 Output Current for Three-Phase 480 V Models

Model	Heavy Duty Rating (HD) Parameter C6-01 = 0		Normal Duty Rating (ND) Parameter C6-01 = 1 (Default)	
	Maximum Motor Output kW (HP)	Rated Output Current A	Maximum Motor Output kW (HP)	Rated Output Current A
4002	0.55 (0.75)	1.8	0.75 (1)	2.1
4004	1.1 (1.5)	3.4	1.5 (2)	4.1
4005	1.5 (2)	4.8	2.2 (3)	5.4
4007	2.2 (3)	5.5	3 (4)	7.1
4009	3.0 (4)	7.2	3.7 (5)	8.9
4012	3.7 (5)	9.2	5.5 (7.5)	11.9
4018	5.5 (7.5)	14.8	7.5 (10)	17.5
4023	7.5 (10)	18	11 (15)	23.4
4031	11 (15)	24	15 (20)	31
4038	15 (20)	31	18.5 (25)	38
4044	18.5 (25)	39	22 (30)	44
4060	22 (30)	45	30 (40)	59.6
4075	30 (40)	60	37 (50)	74.9
4089	37 (50)	75	45 (60)	89.2
4103	45 (60)	91	55 (75)	103
4140	55 (75)	112	75 (100)	140
4168	75 (100)	150	90 (125)	168
4208	90 (125)	180	110 (150)	208
4250	110 (150)	216	150 (200)	250
4302	150 (200)	260	185 (250)	302
4371	185 (250)	304	220 (300)	371
4414	220 (300)	371	260 (350)	414
4477	260 (350)	414	300 (400)	477
4568	300 (400)	477	335 (450)	568
4605	335 (450)	605	370 (500)	675
4720	370 (500)	605	450 (600)	720

1.3 Features and Advantages of Control Methods

This drive has 9 available control methods from which to select for different applications. [Table 1.4](#), [Table 1.5](#), and [Table 1.6](#) give information about the features of each control method.

Table 1.4 V/f and CL-V/f Features and Advantages of Control Methods

Control method selection	V/f Control (V/f)	V/f Control with Encoder (CL-V/f)	Notes
Controlled Motor	Induction Motor		-
Parameter Setting	A1-02 = 0	A1-02 = 1	-
Basic Control	V/f	Closed loop V/f control with speed correction	-
Main Applications	General-purpose variable speed control to connect more than one motor to one drive.	High-precision speed control with encoders on machines	-
PG Option Card	Not necessary	Necessary (PG-B3 or PG-X3)	-
Maximum Output Frequency	590 Hz	400 Hz	-
Speed Control Range	1:40	1:40	This is the range of variable control. When you connect and operate motors in this mode, think about the increase in motor temperature.
Starting Torque	150% / 3 Hz	150% / 3 Hz	This is the motor torque that the drive can supply at low speed during start-up and the related output frequency (rotation speed). You must think about drive capacity and motor capacity when a large quantity of torque is necessary at low speed.
Auto-Tuning ^{*1}	Rotational and Line-to-Line Resistance (usually not necessary)	Rotational and Line-to-Line Resistance (usually not necessary)	Automatically tunes electrical motor parameters.
Torque Limits ^{*1}	No	No	Controls maximum motor torque to prevent damage to machines and loads.
Torque Control ^{*1}	No	No	Directly controls motor torque to control tension and other parameters.
Droop Control ^{*1}	No	No	Sets load torque slip for motors. Distributes motor loads.
Zero Servo Control ^{*1}	No	No	Locks servos without an external position controller to prevent movement caused by external force.
Speed Search ^{*1}	Yes	-	Immediately estimates (or detects) motor speed and direction when coasting to a stop to quickly start-up the drive without stopping the motor.
Automatic Energy-saving Control ^{*1}	Yes	Yes	Automatically adjusts the voltage applied to motors to maximize motor efficiency for all load sizes.
High Slip Braking (HSB) ^{*1}	Yes	Yes	Increases motor loss to let the motor decelerate faster than usual without a braking resistor. Motor characteristics have an effect on this function.
Feed Forward Control ^{*1}	No	No	Compensates effects of the system inertia to increase the speed precision when the load changes.
KEB Ride-Thru Function ^{*1}	Yes	Yes	Quickly and safely stops the motor during power loss and automatically starts operation at the previous speed when restores power without coasting the motor.
Overexcitation Deceleration ^{*1}	Yes	Yes	Sets the V/f higher than the setting value during deceleration to increase motor loss and decrease deceleration time.
Overvoltage Suppression Function ^{*1}	Yes	Yes	Adjusts speed during regeneration to prevent overvoltage.

*1 Note these points when you use this function:

- When you can decouple the motor and machine for a test run, use Rotational Auto-Tuning. You must make adjustments to the control in the range where there is no vibration in the machine after Rotational Auto-Tuning.
- Motor loss increases during overexcitation braking and high-slip braking. Use a maximum braking frequency of 5% ED and a maximum braking time of 90 seconds. After you start high-slip braking, you cannot restart the motor until it stops. Use overexcitation braking to decelerate over a shorter time at a pre-determined speed.

Table 1.5 OLV, CLV and AOLV Features and Advantages of Control Methods

Control method selection	Open Loop Vector (OLV)	Closed Loop Vector (CLV)	Advanced OpenLoop Vector Control (AOLV)	Notes
Controlled Motor	Induction Motor			-
Parameter Setting	A1-02 = 2 (Default)	A1-02 = 3	A1-02 = 4	-
Basic Control	Open Loop Current Vector Control	Closed Loop Current Vector Control	Open Loop Current Vector Control	-
Main Applications	<ul style="list-style-type: none"> General-purpose variable speed control Applications in which high performance is necessary without machine encoders 	Very high-performance control with motor encoders Example: High-precision speed control, torque control, torque limits	Sensorless vector control with speed control <ul style="list-style-type: none"> General-purpose variable speed control Applications in which high performance is necessary without machine encoders 	-
PG Option Card	Not necessary	Necessary (PG-B3 or PG-X3)	Not necessary	-
Maximum Output Frequency	590 Hz	400 Hz	120 Hz	-
Speed Control Range	1:200	1:1500	1:200	This is the range of variable control. When you connect and operate motors in this mode, think about the increase in motor temperature.
Starting Torque	200% / 0.3 Hz ^{*1}	200% / 0 min ⁻¹ ^{*1}	200% / 0.3 Hz ^{*1}	This is the motor torque that the drive can supply at low speed during start-up and the related output frequency (rotation speed). You must think about drive capacity and motor capacity when a large quantity of torque is necessary at low speed.
Auto-Tuning ^{*2}	Rotational, Stationary, and Line-to-Line Resistance	Rotational, Stationary, and Line-to-Line Resistance	Rotational, Stationary, and Line-to-Line Resistance	Automatically tunes electrical motor parameters.
Torque Limits ^{*2}	Yes	Yes	Yes	Controls maximum motor torque to prevent damage to machines and loads.
Torque Control ^{*2}	No	Yes	Yes (Although NOT low speeds of approximately 10% or less)	Directly controls motor torque to control tension and other parameters.
Droop Control ^{*2}	No	Yes	Yes	Sets load torque slip for motors. Distributes motor loads.
Zero Servo Control ^{*2}	No	Yes	No	Locks servos without an external position controller to prevent movement caused by external force.
Speed Search ^{*2}	Yes	-	Yes	Immediately estimates (or detects) motor speed and direction when coasting to a stop to quickly start-up the drive without stopping the motor.
Automatic Energy-saving Control ^{*2}	Yes	Yes	No	Automatically adjusts the voltage applied to motors to maximize motor efficiency for all load sizes.
High Slip Braking (HSB) ^{*2}	No	No	No	Increases motor loss to let the motor decelerate faster than usual without a braking resistor. Motor characteristics have an effect on this function.
Feed Forward Control ^{*2}	No	Yes	Yes	Compensates effects of the system inertia to increase the speed precision when the load changes.
KEB Ride-Thru Function ^{*2}	Yes	Yes	Yes	Quickly and safely stops the motor during power loss and automatically starts operation at the previous speed when restores power without coasting the motor.
Overexcitation Deceleration ^{*2}	Yes	Yes	Yes	Sets the V/f higher than the setting value during deceleration to increase motor loss and decrease deceleration time.
Overvoltage Suppression Function ^{*2}	Yes	Yes	Yes	Adjusts speed during regeneration to prevent overvoltage.

*1 Select the drive capacity and motor capacity accordingly.

1.3 Features and Advantages of Control Methods

*2 Note these points when you use this function:

- When you can decouple the motor and machine for a test run, use Rotational Auto-Tuning. You must make adjustments to the control in the range where there is no vibration in the machine after Rotational Auto-Tuning.
- For vector control, use a 1:1 drive to motor ratio. You cannot use vector control when more than one motor is connected to one drive. Select a drive capacity so that the motor rated current is 50% to 100% of the drive rated current. If the carrier frequency is too high, the drive rated current is derated.
- Motor loss increases during overexcitation braking and high-slip braking. Use a maximum braking frequency of 5% ED and a maximum braking time of 90 seconds. After you start high-slip braking, you cannot restart the motor until it stops. Use overexcitation braking to decelerate over a shorter time at a pre-determined speed.
- Acceleration and deceleration have priority over torque limits in Open Loop Vector Control during acceleration and deceleration (soft start changes). The drive will not operate until the speed is at the minimum frequency or the reverse direction of motor rotation when the motor speed decreases because of torque limits during constant speed control. Set $L7-07 = 1$ [Torque Limit during Accel/Decel = Proportional & Integral control] to enable torque limits during acceleration/deceleration (for winding applications).

Table 1.6 OLV/PM, AOLV/PM, CLV/PM and EZOLV Features and Advantages of Control Methods

Control method selection	PM Open Loop Vector Control (OLV/PM)	PM Advanced Open Loop Vector (AOLV/PM)	PM Closed Loop Vector Control (CLV/PM)	EZ Open Loop Vector Control (EZOLV)	Notes
Controlled Motor	PM Motor			SynRM (Synchronous Reluctance Motors)	-
Parameter Setting	A1-02 = 5	A1-02 = 6	A1-02 = 7	A1-02 = 8	-
Basic Control	PM Open Loop Vector Control (no speed controller)	PM Open Loop Current Vector Control (with speed controller)	PM Closed Loop Current Vector Control (with speed controller)	Open Loop Current Vector Control	-
Main Applications	<ul style="list-style-type: none"> • General-purpose variable speed control for PM motors • Applications in which a high level of responsiveness and accurate speed control are not necessary. 	<ul style="list-style-type: none"> • General-purpose variable speed control for IPM motors • Applications in which high-precision speed control and torque limits are necessary. 	Very high-performance PM motor control with motor encoders Example: Torque control and torque limits	Low-speed torque applications Example: Fans and pumps	-
PG Option Card	Not necessary	Not necessary	Necessary (PG-X3)	Not necessary	-
Maximum Output Frequency	590 Hz	400 Hz	400 Hz	120 Hz	-
Speed Control Range	1:20 AM	1:20 AM 1:100 *1 *2 *3	1:1500	1:100	This is the range of variable control. When you connect and operate motors in this mode, think about the increase in motor temperature.
Starting Torque	100% / 5% speed	100% / 5% speed 200% / 0 min ⁻¹ *1	200% / 0 min ⁻¹ *4	100% / 1% speed	This is the motor torque that the drive can supply at low speed during start-up and the related output frequency (rotation speed). However, you must think about drive capacity and motor capacity when a large quantity of torque is necessary at low speed.
Auto-Tuning *5	Stationary, Stator Resistance, Rotational	Stationary, Stator Resistance, Rotational	Stationary, Stator Resistance, Z-phase, Rotational	Line-to-Line Resistance	Automatically tunes electrical motor parameters.
Torque Limits *5	No	Yes	Yes	Yes	Controls maximum motor torque to prevent damage to machines and loads.
Torque Control *5	No	Yes *6	Yes	No	Directly controls motor torque to control tension and other parameters.
Droop Control *5	No	No	Yes	No	Sets load torque slip for motors. Distributes motor loads.
Zero Servo Control *5	No	No	Yes	No	Locks servos without an external position controller to prevent movement caused by external force.
Speed Search *5	Yes	Yes	Yes	Yes (Although NOT operation in the reverse direction of the Run command)	Immediately estimates (or detects) motor speed and direction when coasting to a stop to quickly start-up the drive without stopping the motor.
Automatic Energy-saving Control *5	No	Yes (IPM motors only)	Yes (IPM motors only)	Yes	Automatically adjusts the voltage applied to motors to maximize motor efficiency for all load sizes.

Control method selection	PM Open Loop Vector Control (OLV/PM)	PM Advanced Open Loop Vector (AOLV/PM)	PM Closed Loop Vector Control (CLV/PM)	EZ Open Loop Vector Control (EZOLV)	Notes
Controlled Motor	PM Motor			SynRM (Synchronous Reluctance Motors)	-
High Slip Braking (HSB)	No (induction motor-specific function)	No (induction motor-specific function)	No (induction motor-specific function)	No	Increases motor loss to let the motor decelerate faster than usual without a braking resistor. Motor characteristics have an effect on this function.
Feed Forward Control *5	No	Yes	Yes	No	Compensates effects of the system inertia to increase the speed precision when the load changes.
KEB Ride-Thru Function *5	Yes	Yes	Yes	Yes	Quickly and safely stops the motor during power loss and automatically starts operation at the previous speed when restores power without coasting the motor.
Overexcitation Deceleration	No (induction motor-specific function)	No (induction motor-specific function)	No (induction motor-specific function)	No	Sets the V/f higher than the setting value during deceleration to increase motor loss and decrease deceleration time.
Overvoltage Suppression Function *5	Yes	Yes	Yes	Yes	Adjusts speed during regeneration to prevent overvoltage.
Sensorless Zero Speed Control *5	No	Yes (IPM motors only)	-	No	Enabled with high frequency injection with IPM motors.

*1 Enabled when $n8-57 = 1$ [*HFI Overlap Selection = Enabled*].

*2 Rotational Auto-Tuning is necessary.

*3 Contact Yaskawa or your nearest sales representative to drive non-Yaskawa PM motors (SSR1 and SST4 series standard specifications).

*4 Select the drive capacity and motor capacity accordingly.

*5 Note these points when you use this function:

- When you can decouple the motor and machine for a test run, use Rotational Auto-Tuning. You must make adjustments to the control in the range where there is no vibration in the machine after Rotational Auto-Tuning.
- For vector control, use a 1:1 drive to motor ratio. You cannot use vector control when more than one motor is connected to one drive. Select a drive capacity so that the motor rated current is 50% to 100% of the drive rated current. If the carrier frequency is too high, the drive rated current is derated.

*6 Torque control at zero speed is only available with IPM motors. To enable torque control with IPM motors at zero speed, set $n8-57 = 1$.

Note:

When you set $n8-35 = 1$ [*Initial Pole Detection Method = High Frequency Injection*] and $n8-57 = 1$, do High Frequency Injection Auto-Tuning.

Mechanical Installation

This section gives information about the standard environment for correct installation.

2.1	Section Safety	32
2.2	Installation Environment	34
2.3	Installation Position and Distance	35
2.4	Moving the Drive.....	37
2.5	Remove and Reattach the Keypad.....	39
2.6	Install the Keypad in a Control Panel or Another Device.....	40
2.7	Removing/Reattaching Covers.....	46
2.8	Change the Drive Enclosure Type.....	51
2.9	Installation Methods	52

2.1 Section Safety

WARNING

Electrical Shock Hazard

Only let approved personnel install, wire, maintain, examine, replace parts, and repair the drive.

If personnel are not approved, it can cause serious injury or death.

Do not modify the drive body or drive circuitry.

Modifications to drive body and circuitry can cause serious injury or death, will cause damage to the drive, and will void the warranty. Yaskawa is not responsible for modifications of the product made by the user.

Fire Hazard

Do not put flammable or combustible materials on top of the drive and do not install the drive near flammable or combustible materials. Attach the drive to metal or other noncombustible material.

Flammable and combustible materials can start a fire and cause serious injury or death.

When you install the drive in an enclosure, use a cooling fan or cooler to decrease the temperature around the drive. Make sure that the intake air temperature to the drive is 50 °C (122 °F) or less for IP20/UL Open Type drives, and 40 °C (104 °F) or less for IP20/UL Type 1 drives.

If the air temperature is too hot, the drive can become too hot and cause a fire and serious injury or death.

Crush Hazard

Only approved personnel can operate a crane or hoist to move the drive.

If unapproved personnel operate a crane or hoist, it can cause serious injury or death from falling equipment.

Before you hang the drive vertically, use screws to correctly attach the drive front cover and other drive components.

If you do not secure the front cover, it can fall and cause minor injury.

When you use a crane or hoist to lift the drive during installation or removal, prevent more than 1.96 m/s² (0.2 G) vibration or impact.

Too much vibration or impact can cause serious injury or death from falling equipment.

When you lift the drive during installation or removal, do not try to turn the drive over and do not ignore the hanging drive.

If you move a hanging drive too much or if you ignore it, the drive can fall and cause serious injury or death.

Use a crane or hoist to move large drives when necessary.

If you try to move a large drive without a crane or hoist, it can cause serious injury or death.

CAUTION

Crush Hazard

Tighten terminal cover screws and hold the case safely when you move the drive.

If the drive or covers fall, it can cause moderate injury.

NOTICE

Do not let unwanted objects, for example metal shavings or wire clippings, fall into the drive during drive installation. Put a temporary cover over the drive during installation. Remove the temporary cover before start-up.

Unwanted objects inside of the drive can cause damage to the drive.

Damage to Equipment

When you touch the drive and circuit boards, make sure that you observe correct electrostatic discharge (ESD) procedures.

If you do not follow procedures, it can cause ESD damage to the drive circuitry.

NOTICE

Install vibration-proof rubber on the base of the motor or use the frequency jump function in the drive to prevent specific frequencies that vibrate the motor.

Motor or system resonant vibration can occur in fixed speed machines that are converted to variable speed. Too much vibration can cause damage to equipment.

You can use the drive with an explosion-proof motor, but the drive is not explosion-proof. Install the drive only in the environment shown on the nameplate.

If you install the drive in a dangerous environment, it can cause damage to the drive.

Do not lift the drive with the covers removed.

If the drive does not have covers, you can easily cause damage to the internal parts of the drive.

2.2 Installation Environment

The installation environment is important for the lifespan of the product and to make sure that the drive performance is correct. Make sure that the installation environment agrees with these specifications.

Environment	Conditions
Area of Use	Indoors
Power Supply	Overvoltage Category III
Ambient Temperature Setting	IP20/UL Open Type/Heatsink External Mounting: -10 °C to +50 °C (14 °F to 122 °F) IP20/UL Type 1: -10 °C to +40 °C (14 °F to 104 °F) IP55/UL Type 12 Heatsink External Mounting; front side: -10°C to +50 °C (14 °F to 122 °F) IP55/UL Type 12 Heatsink External Mounting; back side: -10°C to +40 °C (14 °F to 104 °F) <ul style="list-style-type: none"> • When installing the drive in an enclosure, use a cooling fan or air conditioner to keep the internal air temperature in the permitted range. • Do not let the drive freeze. • You can use IP20/UL Open Type drives at a maximum of 60 °C (140 °F) when you derate the output current. • You can use IP20/UL Type 1 drives at a maximum of 50 °C (122 °F) when you derate the output current.
Humidity	95%RH or less Do not let condensation form on the drive.
Storage Temperature	-20 °C to +70 °C (-4 °F to +158 °F) (short-term temperature during transportation)
Surrounding Area	Pollution degree 2 or less Install the drive in an area without: <ul style="list-style-type: none"> • Oil mist, corrosive or flammable gas, or dust • Metal powder, oil, water, or other unwanted materials • Radioactive or flammable materials. • Harmful gas or fluids • Salt • Direct sunlight Keep wood and other flammable materials away from the drive.
Altitude	1000 m (3281 ft) maximum Note: Derate the output current by 1% for each 100 m (328 ft) to install the drive in altitudes between 1000 m to 4000 m (3281 ft to 13123 ft). It is not necessary to derate the rated voltage in these conditions: <ul style="list-style-type: none"> • Installing the drive at 2000 m (6562 ft) or lower • Installing the drive between 2000 m to 4000m (6562 ft to 13123 ft) and grounding the neutral point on the power supply. Contact Yaskawa or your nearest sales representative when not grounding the neutral point.
Vibration	<ul style="list-style-type: none"> • 10 to 20 Hz: 1 G (9.8 m/s², 32.15 ft/s²) • 20 Hz to 55 Hz: 2004 to 2211, 4002 to 4168: 0.6 G (5.9 m/s², 19.36 ft/s²) 2257 to 2415, 4208 to 4720: 0.2 G (2.0 m/s², 6.56 ft/s²)
Installation Orientation	Install the drive vertically for sufficient airflow to cool the drive.

NOTICE: Do not let unwanted objects, for example metal shavings or wire clippings, fall into the drive during drive installation. Put a temporary cover over the drive during installation. Remove the temporary cover before start-up. Unwanted objects inside of the drive can cause damage to the drive.

Note:

Do not put drive peripheral devices, transformers, or other electronics near the drive. Shield the drive from electrical interference if components must be near the drive. The drive or the devices around the drive may malfunction due to electrical interference.

2.3 Installation Position and Distance

Install the drive vertically for sufficient airflow to cool the drive.

Note:

Contact Yaskawa or a Yaskawa representative for more information about installing drive models on their side.

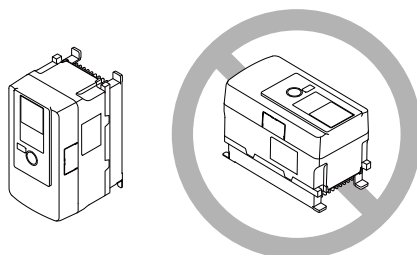

A

B

A - Vertical installation

B - Horizontal installation

Figure 2.1 Installation Orientation

◆ Single Drive Installation

Use the clearances specified in Figure 2.2 to install the drive. Make sure that there is sufficient space for wiring and airflow to cool the drive.

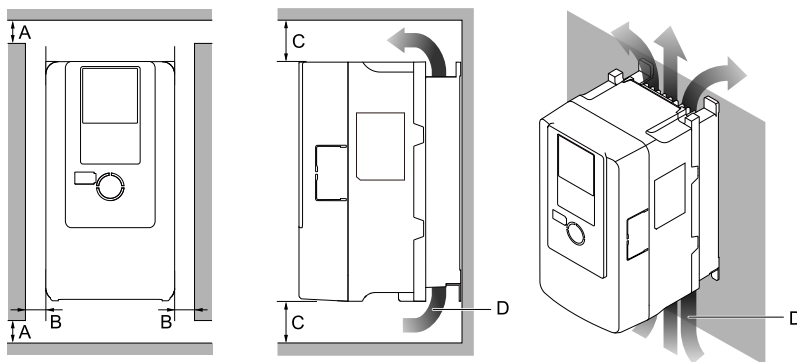

A - 50 mm (2 in) minimum
B - 30 mm (1.2 in) minimum on both sides

C - 120 mm (4.7 in) minimum above and below
D - Airflow direction

Figure 2.2 Installation Distances for One Drive

◆ Install Drives Side-by-Side

Users can install drive models 2004xB to 2082xB and 4002xB to 4044xB side-by-side.

When you install other drives side-by-side, keep the space that is sufficient for single drive installation between the drives.

Side-by-side installation requires the installation space shown in Figure 2.3. Set L8-35 = 1 [Installation Method Selection = Side-by-Side Mounting].

With reference to *Derating Depending on Ambient Temperature on page 450*, set derating depending on ambient temperature.

2.3 Installation Position and Distance

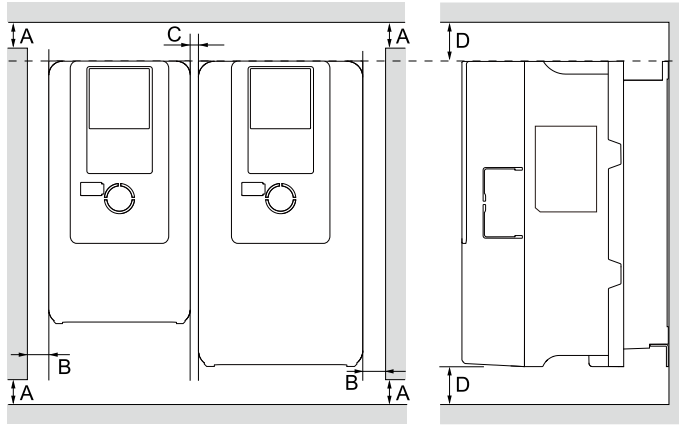

A - 50 mm (2 in) minimum

B - 30 mm (1.2 in) minimum on both sides

C - 2 mm (0.08 in) minimum between each drive

D - 120 mm (4.7 in) minimum above and below

Figure 2.3 Installation Distances for Multiple Drives (Side-by-Side)

Note:

- Align the tops of drives that have different dimensions to help when you replace cooling fans.
- Remove the top protective covers of all drives when mounting UL Type 1 enclosure drives side-by-side.

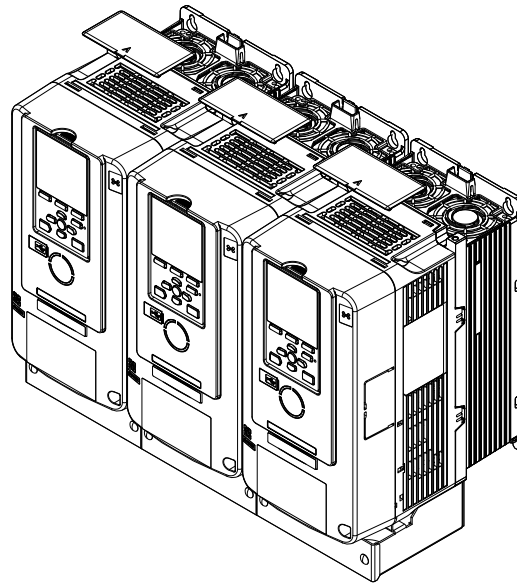

Figure 2.4 Enclosed Wall-Mounted Type (UL Type 1) Installed Side-by-Side

2.4 Moving the Drive

Obey local laws and regulations when you move and install this product.

CAUTION! *Crush Hazard. Tighten terminal cover screws and hold the case safely when you move the drive. If the drive or covers fall, it can cause moderate injury.*

Drive Weight	Persons Necessary to Move the Drive
< 15 kg (33 lbs.)	1
≥ 15 kg (33 lbs.)	2 + using appropriate lifting equipment

Refer to [Using the Hanging Brackets to Move the Drive on page 37](#) for information about how to use suspension systems, wires, or hanging metal brackets to move the drive.

◆ Using the Hanging Brackets to Move the Drive

Use the hanging brackets attached to the drive to temporarily lift the drive when you install the drive to a control panel or wall or when you replace the drive. Do not let the drive stay vertically or horizontally suspended or move the drive over a long distance while it is suspended.

Before you install the drive, make sure that you read these precautions:

WARNING! *Crush Hazard. Before you hang the drive vertically, use screws to correctly attach the drive front cover and other drive components. If you do not secure the front cover, it can fall and cause minor injury.*

WARNING! *Crush Hazard. When you use a crane or hoist to lift the drive during installation or removal, prevent more than 1.96 m/s² (0.2 G) vibration or impact. Too much vibration or impact can cause serious injury or death from falling equipment.*

WARNING! *Crush Hazard. When you lift the drive during installation or removal, do not try to turn the drive over and do not ignore the hanging drive. If you move a hanging drive too much or if you ignore it, the drive can fall and cause serious injury or death.*

WARNING! *Crush Hazard. When you install the drive, do not hold the front cover. Install the drive with holding the heatsink. If you hold the front cover, the cover will come off and the drive will fall, then it can cause injury.*

◆ Instructions on Drive Suspension

Use the procedures in this section to suspend the drive with wires.

Model	Suspension Method
2110 - 2415 4075 - 4720	Vertical Suspension
2138 - 2415 4089 - 4720	Allows horizontal suspension

■ Vertical Suspension

To vertically suspend the drive with the hanging brackets, lift the drive with this procedure:

1. Put wire through the 2 holes in the hanging brackets.

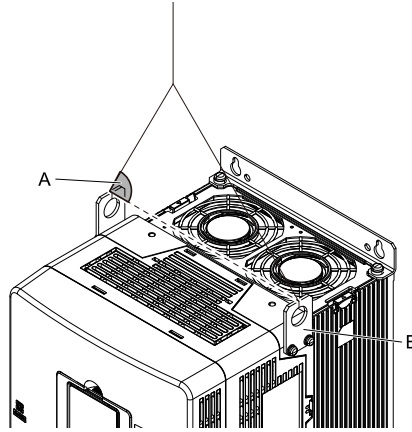

A - Suspension angle of at least 50 degrees

B - Hanging bracket (2)

Figure 2.5 Vertical Suspension

2. Use a crane to gradually wind up the wire. Visually make sure that there is sufficient tension in the wire, then lift the drive to its correct location.
3. Prepare the control panel for installation, then lower the drive.

Note:

When lowering the drive, stop before the drive touches the floor, then slowly lower it the remaining distance.

■ Horizontal Suspension

If a horizontal suspension is required in the installation environment, hang the drive through the following steps.

Put the drive on the ground horizontally. Connect wires to the 4 hanging brackets and use a crane to lift the drive.

NOTICE: When you attach a horizontal lifting cable or chain to the drive, use a jig or pad between the wire and the drive. The wire can scratch the drive and cause damage to the drive.

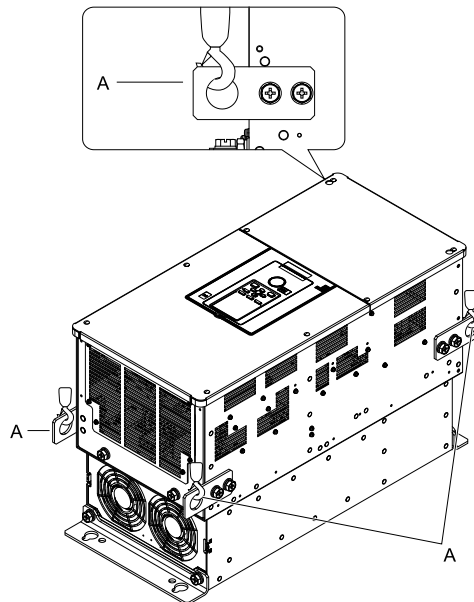

A - Hanging bracket (4)

Figure 2.6 Horizontal Suspension

2.5 Remove and Reattach the Keypad

NOTICE: You must remove the keypad before you remove or reattach the front cover. Before you reattach the keypad, make sure that you attach the front cover into position. If you keep the keypad connected to the drive when you remove the front cover, it can cause an unsatisfactory connection and incorrect operation.

◆ Remove the Keypad

1. Push down the tab on the top of the keypad, then pull the keypad forward and remove it from the drive.

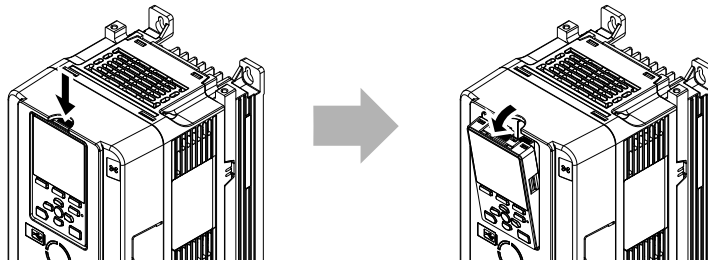
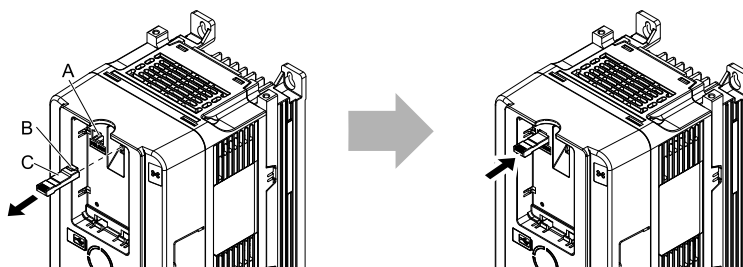

Figure 2.7 Remove the Keypad

2. Pull the keypad connector out from the drive horizontally, then put it in the holder.

Note:

Insert the end of the keypad connector that has the tab.



A - Holder
B - Hook

C - Keypad connector

Figure 2.8 Move the Keypad Connector to the Holder

◆ Reattach the Keypad

Insert the keypad connector to its initial position. Put the bottom of the keypad into position first, then carefully push on the top of the keypad until the hook clicks into place.

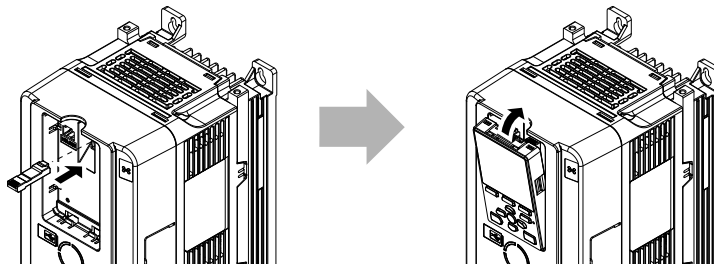

Figure 2.9 Reattach the Keypad

2.6 Install the Keypad in a Control Panel or Another Device

◆ Operate the Keypad from a Remote Location

You can remove the keypad from the drive and connect it to a remote control extension cable 3 m (9.8 ft) long to make operation easier when you cannot access the drive. You can operate a drive that is in a control panel without opening or closing the control panel door. To order optional accessories, contact Yaskawa or your nearest sales representative.

Name	Model	Intended Use
Extension Cable	1 m: WV001 3 m: WV003	To connect the keypad and drive. This option is an RJ-45, 8-pin straight-through UTP CAT5e cable.
Installation Support Set A	900-192-933-001	To attach the keypad to the control panel. This option uses screws.
Installation Support Set B	900-192-933-002	To attach the keypad to the control panel. This option uses nut clamps. Use this option when weld studs are located in the control panel.

◆ Connect the Keypad from a Remote Location

Use the information in [Table 2.1](#) to install the keypad in the best location for your application.

Table 2.1 Keypad Installation Method

Installation Method	Features	Necessary Tools and Installation Support Sets
Outside of the control panel	Simplified installation is possible. Separate installation support sets are not necessary.	Phillips screwdriver #2 (M3)
Inside of the control panel	Keypad does not extend farther than the front of the control panel.	<ul style="list-style-type: none"> Phillips screwdriver #2 (M3, M4) Installation support set A (for mounting with screws, model: 900-192-933-001)
		<ul style="list-style-type: none"> Phillips screwdriver #2 (M3) Wrench (M4) Installation support set B (for mounting with nut clamp, model: 900-192-933-002)

Note:

Installation support sets are sold separately. If there are weld studs inside the control panel, use installation support set B. Contact Yaskawa or your nearest sales representative to make an order.

NOTICE: Do not let unwanted objects, for example metal shavings or wire clippings, fall into the drive during drive installation. Put a temporary cover over the drive during installation. Remove the temporary cover before start-up. Unwanted objects inside of the drive can cause damage to the drive.

■ External Dimensions of Keypad

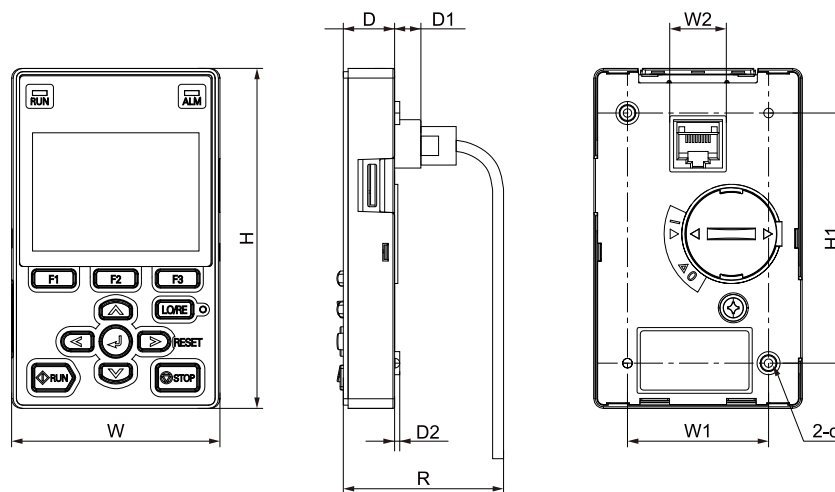

Figure 2.10 Exterior and Mounting Dimensions

Table 2.2 Exterior Dimensions (mm)

W	H	D	D1	D2	R *1	W1	W2	H1	d
65	106	16	8.2	1.6	53.8	44	15	78	M3

*1 Minimum bending radius

Mount to the Outside of Control Panel

1. Use the panel cut-out dimensions in [Figure 2.11](#) and [Table 2.3](#) to cut an opening in the control panel for the keypad.

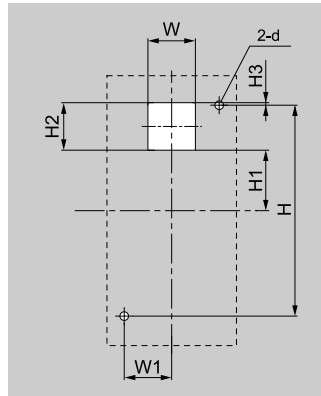

Figure 2.11 Panel Cut-Out Dimensions to Attach Outside of Control Panel

Table 2.3 Panel Cut-out Dimensions mm (in)

W	H	W1	H1	H2	H3	d
22 (0.89)	78 (3.07)	22 (0.89)	29 (1.14)	22 (0.89)	1 (0.04)	3.6 (0.14)

2. Remove the keypad and put the keypad connector in the holder on the front cover.

Note:

Insert the end of the keypad connector that has the tab.

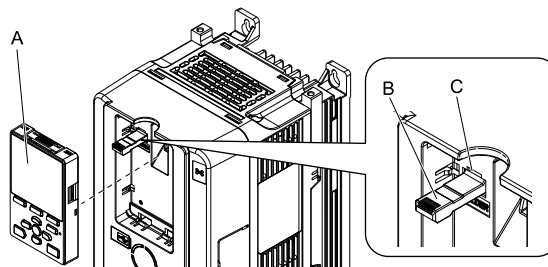

A - Keypad
B - Keypad connector

C - Holder

Figure 2.12 Remove the Keypad

3. Put the keypad on the outside of the control panel.
Use M3 screws (6 mm (0.2 in) depth cross-recessed pan head screws) to attach the keypad from the inside. Tighten the screws to a tightening torque of 0.49 N·m to 0.73 N·m (4.34 in·lb to 6.46 in·lb).

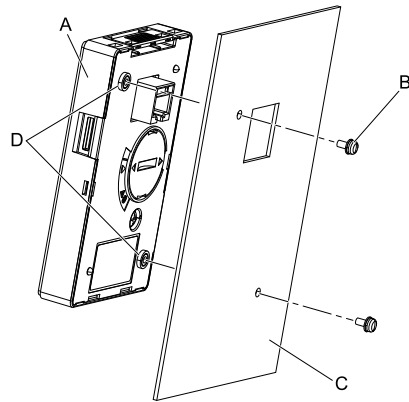

A - Keypad

B - M3 screws

C - Enclosure panel

D - Screw mounting hole

Figure 2.13 Mount to the Outside of Control Panel

4. Use the remote control extension cable to connect the keypad to the drive.

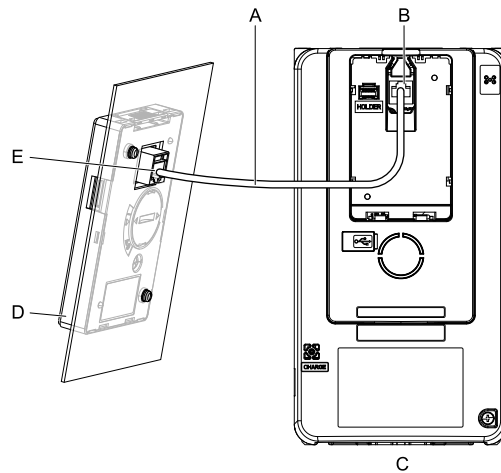

A - Remote control extension

B - Communications connector

C - Drive

D - Keypad

E - Cable connector

Figure 2.14 Connect the Drive and Keypad with the Remote Control Extension Cable

■ Install Inside Control Panel

To attach the keypad inside of the control panel, you must purchase the installation support set, which is sold separately. Contact Yaskawa or your nearest sales representative to order mounting brackets and mounting hardware.

Note:

- The installation procedure and panel cut-out dimensions are the same for mounting brackets A and B.
- Use a gasket between the control panel and the keypad in environments with a large quantity of dust or other unwanted airborne material.

1. Use the panel cut-out dimensions in [Figure 2.15](#) and [Table 2.4](#) to cut an opening in the control panel for the keypad.

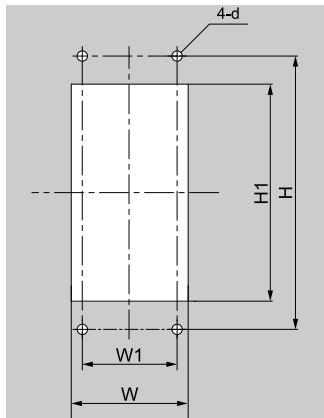

Figure 2.15 Panel Cut-Out Dimensions to Attach Inside Control Panel

Table 2.4 Panel Cut-out Dimensions mm (in)

W	H	W1	H1	d
64 + 0.5 (2.52 + 0.02)	130 (5.12)	45 (1.77)	105 + 0.5 (4.13 + 0.02)	4.8 (0.12)

2. Remove the keypad and put the keypad connector in the holder on the front cover.

Note:

Insert the end of the keypad connector that has the tab.

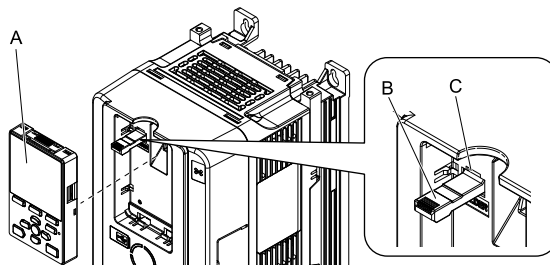

A - Keypad
B - Keypad connector

C - Holder

Figure 2.16 Remove the Keypad

3. Use the screws supplied with the mounting bracket, and attach the keypad to the mounting bracket. Use the screws supplied with the installation support set, and tighten them to a tightening torque of 0.49 to 0.73 N·m (4.34 to 6.46 in·lb).

2.6 Install the Keypad in a Control Panel or Another Device

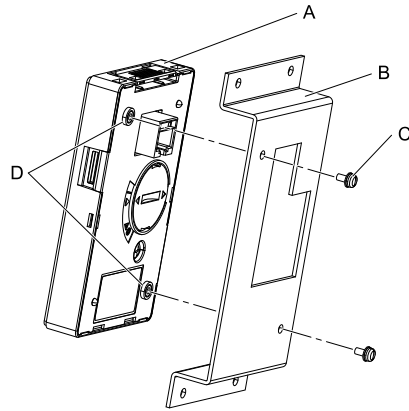

A - Keypad

B - Mounting bracket A

C - M3 screws

D - Screw mounting hole

Figure 2.17 Attach Keypad to Mounting Bracket

4. Position the mounting bracket to which the keypad has been attached in the control panel, and mount it from the outside using the screws.

Use the screws supplied with the installation support set, and tighten them to a tightening torque of 0.98 to 1.33 N·m (8.67 to 11.77 in·lb).

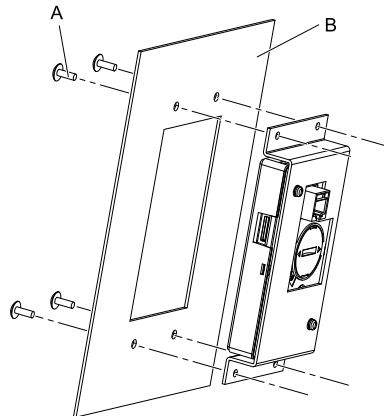

A - M4 screw

B - Enclosure panel

Figure 2.18 Mount Mounting Bracket to the Interior of the Control Panel

5. Use the remote control extension cable to connect the keypad to the drive.

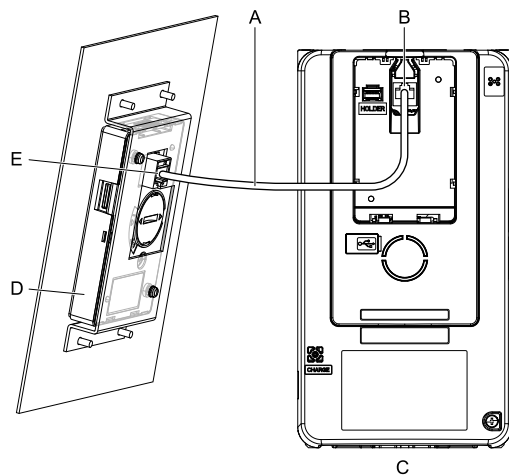

- | | |
|-------------------------------------|----------------------------|
| A - Remote control extension | D - Keypad |
| B - Communications connector | E - Cable connector |
| C - Drive | |

Figure 2.19 Connect the Drive and Keypad with the Remote Control Extension Cable

2.7 Removing/Reattaching Covers

This section gives information about how to remove and reattach the front cover and terminal cover for wiring and inspection.

Different drive models have different procedures to remove and reattach the covers. Refer to [Table 2.5](#) for more information.

Table 2.5 Procedures to Remove Covers by Drive Model

Model	Procedure	Reference
2004 - 2211 4002 - 4168	Procedure A	46
2257 - 2415 4208 - 4720	Procedure B	47

◆ Removing/Reattaching the Cover Using Procedure A

DANGER! Electrical Shock Hazard. Do not examine, connect, or disconnect wiring on an energized drive. Before servicing, disconnect all power to the equipment and wait for the time specified on the warning label at a minimum. The internal capacitor stays charged after the drive is de-energized. The charge indicator LED extinguishes when the DC bus voltage decreases below 50 Vdc. When all indicators are OFF, remove the covers before measuring for dangerous voltages to make sure that the drive is safe. If you do work on the drive when it is energized, it will cause serious injury or death from electrical shock. The drive has internal capacitors that stay charged after you de-energize the drive.

■ Remove the Front Cover

1. Remove the keypad and the keypad connector, then insert the end of the keypad connector that has the tab into the keypad connector holder on the front cover.

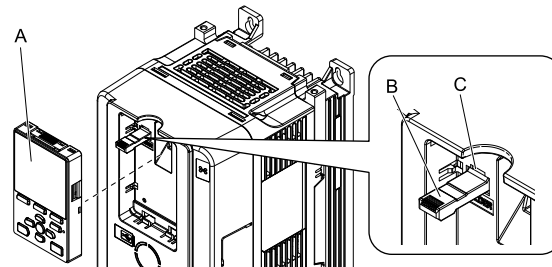

A - Keypad

B - Keypad connector

C - Holder

Figure 2.20 Remove the Keypad and Keypad Connector

2. Loosen the front cover screws.

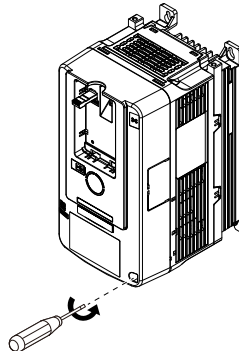

Figure 2.21 Loosen the Front Cover Screws

3. Push on the tab in the side of the front cover then pull the front cover forward to remove it from the drive.

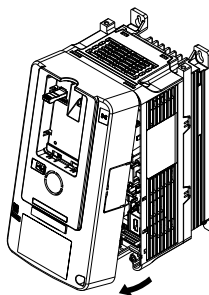

Figure 2.22 Remove the Front Cover

■ Reattach the Front Cover

1. Wire the drive and other peripheral devices.
2. Reverse the steps to reattach the cover.

Note:

- Wire the grounding terminals first, main circuit terminals next, and control circuit terminals last.
- Make sure that you do not pinch wires or signal lines between the front cover and the drive before you reattach the cover.
- Tighten the screws to a tightening torque of 0.98 N·m to 1.33 N·m (8.67 lb·in. to 11.77 lb·in.).

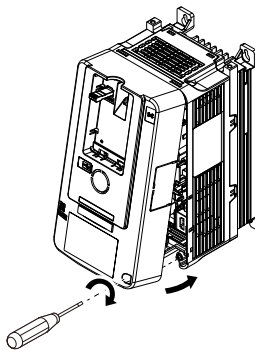

Figure 2.23 Reattach the Front Cover

3. Reattach the keypad to the original position.

◆ Removing/Reattaching the Cover Using Procedure B

DANGER! Electrical Shock Hazard. Do not examine, connect, or disconnect wiring on an energized drive. Before servicing, disconnect all power to the equipment and wait for the time specified on the warning label at a minimum. The internal capacitor stays charged after the drive is de-energized. The charge indicator LED extinguishes when the DC bus voltage decreases below 50 Vdc. When all indicators are OFF, remove the covers before measuring for dangerous voltages to make sure that the drive is safe. If you do work on the drive when it is energized, it will cause serious injury or death from electrical shock. The drive has internal capacitors that stay charged after you de-energize the drive.

■ **Remove the Front Cover**

1. Remove the terminal cover, keypad, and keypad connector, then insert the end of the keypad connector that has the tab into the keypad connector holder on the front cover.

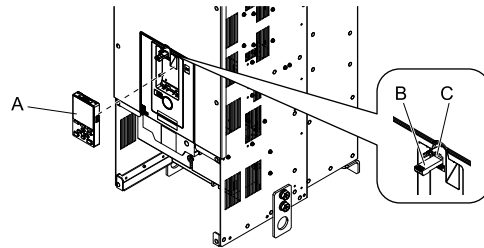

A - Keypad

B - Keypad connector

C - Connector holder

Figure 2.24 Remove the Terminal Cover, Keypad, and Keypad Connector

2. Loosen the front cover screws.

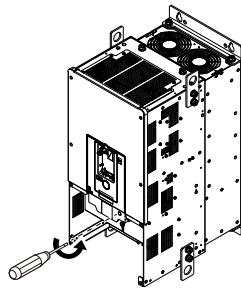
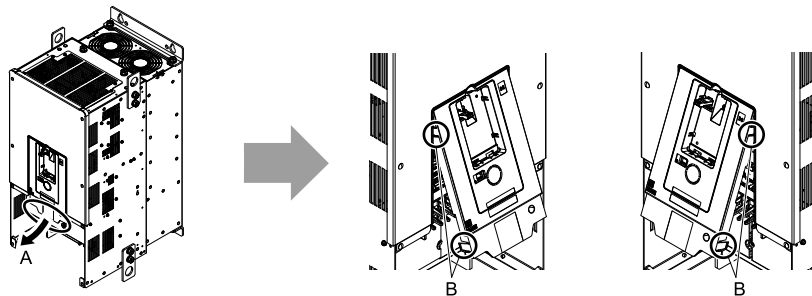

Figure 2.25 Loosen the Front Cover Screws

3. Push on the four tabs found on each side of the front cover, then pull the front cover forward to remove it from the drive.



A - Pull forward to remove the front cover.

B - Unhook the tabs found on the sides of the front cover.

Figure 2.26 Pull Forward to Remove the Front Cover

4. Remove the front cover from the drive.

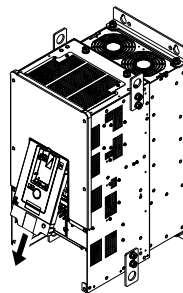

Figure 2.27 Remove the Front Cover

■ Reattach the Front Cover

Wire the drive and other peripheral devices then reattach the front cover.

Note:

Wire the grounding terminals first, main circuit terminals next, and control circuit terminals last.

1. Move the front cover to connect the hooks at the top of the front cover to the drive.

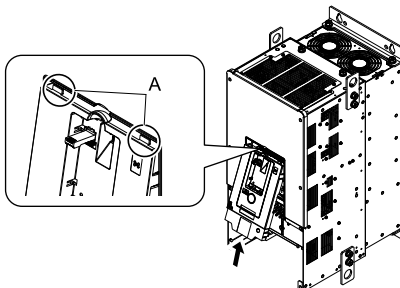

A - Hooks

Figure 2.28 Reattach the Front Cover

2. Move the front cover until it clicks into position while pushing on the hooks on the left and right sides of the front cover.

Note:

Make sure that you do not pinch wires or signal lines between the front cover and the drive before you reattach the cover.

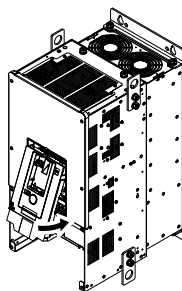

Figure 2.29 Reattach the Front Cover

3. Reattach the keypad to the original position.

■ Remove the Terminal Cover

1. Loosen the screws on the terminal cover, then pull down on the cover.

CAUTION! *Crush Hazard. Loosen the cover screws. Do not fully remove them. If you fully remove the cover screws, the terminal cover can fall and cause moderate injury.*

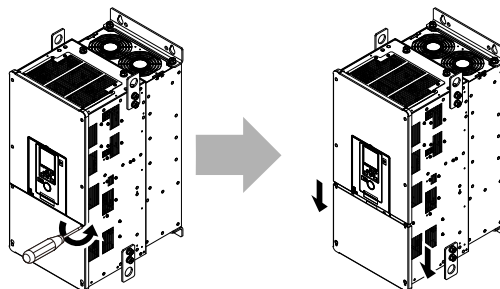

Figure 2.30 Loosen the Terminal Cover Mounting Screws

2. Pull the terminal cover away from the drive.

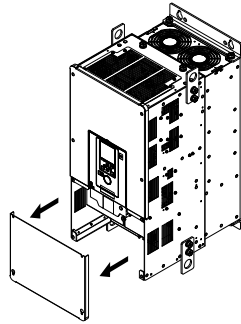

Figure 2.31 Remove the Terminal Cover

■ Reattach the Terminal Cover

Wire the drive and other peripheral devices then reattach the terminal cover.

Note:

- Wire the grounding terminals first, main circuit terminals next, and control circuit terminals last.
- Make sure that you do not pinch wires or signal lines between the wiring cover and the drive before you reattach the cover.
- Tighten the screws to a tightening torque of 0.98 N·m to 1.33 N·m (8.67 in·lb to 11.77 in·lb).

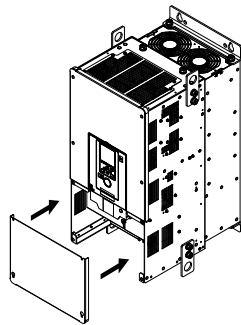

Figure 2.32 Reattach the Terminal Cover

2.8 Change the Drive Enclosure Type

The enclosure type of the drive is IP20/UL Open Type. You must install a UL Type 1 kit to change the enclosure type to an enclosed, IP20/UL Type 1.

Install the kit before you wire the drive.

Different drives use different UL Type 1 kits. Refer to [Table 2.6](#) to find the kit for your drive. Contact Yaskawa or your nearest sales representative for more information about UL Type 1 kits.

Table 2.6 UL Type 1 Kits by Drive Model

Model	Option Model
2004, 2006, 2008, 2010, 2012, 2018, 2021, 2030, 2042 4002, 4004, 4005, 4007, 4009, 4012, 4018, 4023	900-192-121-001
2056 4031, 4038	900-192-121-002
2070 4044, 4060	900-192-121-003
2082	900-192-121-004
2110 4075	900-192-121-005
2138 4089, 4103	900-192-121-006
2169 4140, 4168	900-192-121-007
2211	900-192-121-008
2257, 2313 4208, 4250, 4302	900-192-121-009
2360, 2415	900-192-121-010
4371, 4414	UUX001700
4477, 4568, 4605, 4720	UUX001701

2.9 Installation Methods

The drive installation methods include standard installation and external heatsink installation.

◆ Standard Installation

Refer to *Drive Exterior and Mounting Dimensions on page 452* for more information about external dimensions and installation methods.

◆ External Heatsink Installation

Table 2.8, Table 2.9, and Table 2.10 show the panel cut-out dimensions for external heatsink installations. An attachment is necessary to install drive models smaller than 2082 (200 V class) and 4060 (400 V class) with the heatsink outside of the panel.

Note:

- The exterior mounting dimensions and installation dimensions for a standard installation are different than the dimensions for an external heatsink installation.
- The shaded parts of the panel cut-out dimensions are the gasket dimensions. Make sure that the gasket is not smaller than the specified dimension.

Table 2.7 External Heatsink Installation Kit

Drive Model	Model
2004 to 2042 4002 to 4023	900-193-209-001
2056 4031, 4038	900-193-209-002
2070, 2082 4044, 4060	900-193-209-003
2110 to 2415 4075 to 4720	-

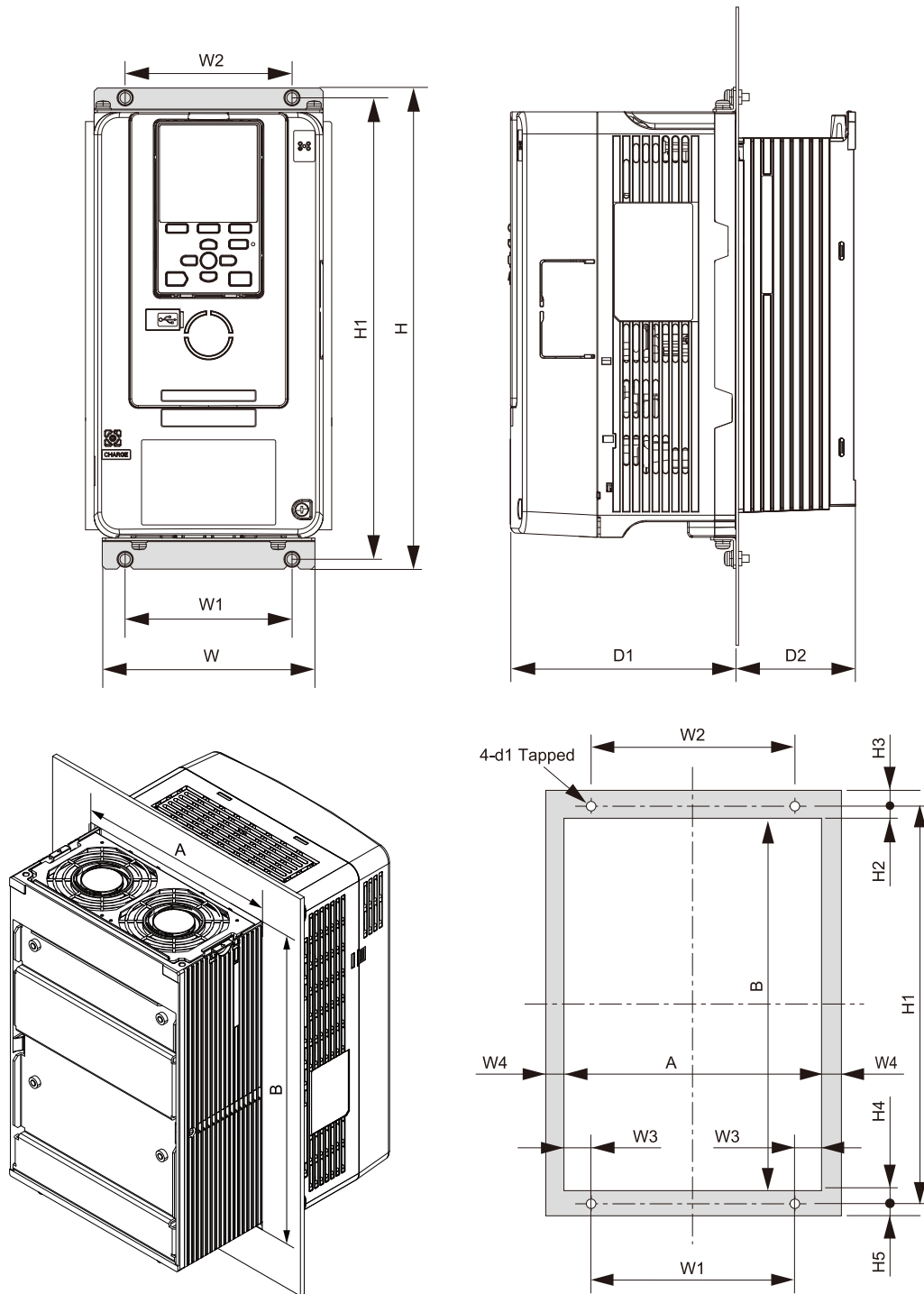

Figure 2.33 Panel Cut-Out Dimensions

Table 2.8 Panel Cut-Out Dimensions (200 V Class)

Model	Dimensions mm (in)															
	W	H	D1	D2	W1	W2	W3	W4	H1	H2	H3	H4	H5	A	B	d1
2004 *I	140 (5.51)	294 (11.57)	138 (5.43)	38 (1.50)	102 (4.02)	102 (4.02)	16 (0.63)	3 (0.12)	282 (11.10)	23 (0.91)	6 (0.24)	26 (1.02)	6 (0.24)	134 (5.28)	233 (9.17)	M5
2006 *I	140 (5.51)	294 (11.57)	138 (5.43)	38 (1.50)	102 (4.02)	102 (4.02)	16 (0.63)	3 (0.12)	282 (11.10)	23 (0.91)	6 (0.24)	26 (1.02)	6 (0.24)	134 (5.28)	233 (9.17)	M5
2008 *I	140 (5.51)	294 (11.57)	138 (5.43)	38 (1.50)	102 (4.02)	102 (4.02)	16 (0.63)	3 (0.12)	282 (11.10)	23 (0.91)	6 (0.24)	26 (1.02)	6 (0.24)	134 (5.28)	233 (9.17)	M5

2.9 Installation Methods

Model	Dimensions mm (in)															
	W	H	D1	D2	W1	W2	W3	W4	H1	H2	H3	H4	H5	A	B	d1
2010 *1	140 (5.51)	294 (11.57)	138 (5.43)	38 (1.50)	102 (4.02)	102 (4.02)	16 (0.63)	3 (0.12)	282 (11.10)	23 (0.91)	6 (0.24)	26 (1.02)	6 (0.24)	134 (5.28)	233 (9.17)	M5
2012 *1	140 (5.51)	294 (11.57)	138 (5.43)	38 (1.50)	102 (4.02)	102 (4.02)	16 (0.63)	3 (0.12)	282 (11.10)	23 (0.91)	6 (0.24)	26 (1.02)	6 (0.24)	134 (5.28)	233 (9.17)	M5
2018 *1	140 (5.51)	294 (11.57)	138 (5.43)	73 (2.87)	102 (4.02)	102 (4.02)	16 (0.63)	3 (0.12)	282 (11.10)	23 (0.91)	6 (0.24)	26 (1.02)	6 (0.24)	134 (5.28)	233 (9.17)	M5
2021 *1	140 (5.51)	294 (11.57)	138 (5.43)	73 (2.87)	102 (4.02)	102 (4.02)	16 (0.63)	3 (0.12)	282 (11.10)	23 (0.91)	6 (0.24)	26 (1.02)	6 (0.24)	134 (5.28)	233 (9.17)	M5
2030 *1	140 (5.51)	294 (11.57)	138 (5.43)	73 (2.87)	102 (4.02)	102 (4.02)	16 (0.63)	3 (0.12)	282 (11.10)	23 (0.91)	6 (0.24)	26 (1.02)	6 (0.24)	134 (5.28)	233 (9.17)	M5
2042 *1	140 (5.51)	294 (11.57)	138 (5.43)	73 (2.87)	102 (4.02)	102 (4.02)	16 (0.63)	3 (0.12)	282 (11.10)	23 (0.91)	6 (0.24)	26 (1.02)	6 (0.24)	134 (5.28)	233 (9.17)	M5
2056 *1	180 (7.09)	329 (12.95)	134 (5.28)	68 (2.68)	140 (5.51)	140 (5.51)	17 (0.67)	3 (0.12)	318 (12.52)	23.5 (0.93)	5 (0.20)	24.5 (0.97)	6 (0.24)	174 (6.85)	270 (10.63)	M5
2070 *1	220 (8.66)	384 (15.12)	140 (5.51)	87 (3.43)	192 (7.56)	192 (7.56)	11 (0.43)	3 (0.12)	371 (14.61)	27 (1.06)	7 (0.28)	25 (0.98)	6 (0.24)	214 (8.43)	319 (12.56)	M6
2082 *1	220 (8.66)	384 (15.12)	140 (5.51)	87 (3.43)	192 (7.56)	192 (7.56)	11 (0.43)	3 (0.12)	371 (14.61)	27 (1.06)	7 (0.28)	25 (0.98)	6 (0.24)	214 (8.43)	319 (12.56)	M6
2110	240 (9.45)	400 (15.75)	166 (6.54)	114 (4.49)	195 (7.68)	204 (8.03)	14.5 (0.57)	8 (0.32)	385 (15.16)	19.5 (0.77)	7.5 (0.30)	19.5 (0.77)	7.5 (0.30)	224 (8.82)	346 (13.62)	M6
2138	255 (10.04)	450 (17.72)	166 (6.54)	114 (4.49)	170 (6.69)	210 (8.27)	34.5 (1.36)	8 (0.32)	436 (17.17)	20 (0.79)	8 (0.32)	20 (0.79)	6 (0.24)	239 (9.41)	396 (15.59)	M6
2169	264 (10.39)	543 (21.38)	186 (7.32)	149 (5.87)	190 (7.48)	220 (8.66)	29 (1.14)	8 (0.32)	527 (20.75)	19.5 (0.77)	8.5 (0.34)	20.5 (0.81)	7.5 (0.30)	248 (9.76)	487 (19.17)	M8
2211	264 (10.39)	543 (21.38)	186 (7.32)	149 (5.87)	190 (7.48)	220 (8.66)	29 (1.14)	8 (0.32)	527 (20.75)	19.5 (0.77)	8.5 (0.34)	20.5 (0.81)	7.5 (0.30)	248 (9.76)	487 (19.17)	M8
2257	312 (12.28)	700 (27.56)	260 (10.24)	160 (6.30)	218 (8.58)	263 (10.35)	39 (1.54)	8 (0.32)	675 (26.56)	33 (1.30)	12 (0.47)	32 (1.26)	13 (0.51)	296 (11.65)	610 (24.02)	M10
2313	312 (12.28)	700 (27.56)	260 (10.24)	160 (6.30)	218 (8.58)	263 (10.35)	39 (1.54)	8 (0.32)	675 (26.56)	33 (1.30)	12 (0.47)	32 (1.26)	13 (0.51)	296 (11.65)	610 (24.02)	M10
2360	440 (17.32)	800 (31.50)	254 (10.00)	218 (8.58)	370 (14.57)	310 (12.20)	23 (0.91)	12 (0.47)	773 (30.43)	31.5 (1.24)	14 (0.55)	31.5 (1.24)	13 (0.51)	416 (16.38)	710 (27.95)	M12
2415	440 (17.32)	800 (31.50)	254 (10.00)	218 (8.58)	370 (14.57)	310 (12.20)	23 (0.91)	12 (0.47)	773 (30.43)	31.5 (1.24)	14 (0.55)	31.5 (1.24)	13 (0.51)	416 (16.38)	710 (27.95)	M12

*1 The External Heatsink Installation Kit is necessary.

Table 2.9 Panel Cut-out Dimensions (Models 4002 to 4414)

Model	Dimensions mm (in)															
	W	H	D1	D2	W1	W2	W3	W4	H1	H2	H3	H4	H5	A	B	d1
4002 *1	140 (5.51)	294 (11.57)	138 (5.43)	38 (1.50)	102 (4.02)	102 (4.02)	16 (0.63)	3 (0.12)	282 (11.10)	23 (0.91)	6 (0.24)	26 (1.02)	6 (0.24)	134 (5.28)	233 (9.17)	M5
4004 *1	140 (5.51)	294 (11.57)	138 (5.43)	38 (1.50)	102 (4.02)	102 (4.02)	16 (0.63)	3 (0.12)	282 (11.10)	23 (0.91)	6 (0.24)	26 (1.02)	6 (0.24)	134 (5.28)	233 (9.17)	M5
4005 *1	140 (5.51)	294 (11.57)	138 (5.43)	38 (1.50)	102 (4.02)	102 (4.02)	16 (0.63)	3 (0.12)	282 (11.10)	23 (0.91)	6 (0.24)	26 (1.02)	6 (0.24)	134 (5.28)	233 (9.17)	M5
4007 *1	140 (5.51)	294 (11.57)	138 (5.43)	73 (2.87)	102 (4.02)	102 (4.02)	16 (0.63)	3 (0.12)	282 (11.10)	23 (0.91)	6 (0.24)	26 (1.02)	6 (0.24)	134 (5.28)	233 (9.17)	M5
4009 *1	140 (5.51)	294 (11.57)	138 (5.43)	73 (2.87)	102 (4.02)	102 (4.02)	16 (0.63)	3 (0.12)	282 (11.10)	23 (0.91)	6 (0.24)	26 (1.02)	6 (0.24)	134 (5.28)	233 (9.17)	M5
4012 *1	140 (5.51)	294 (11.57)	138 (5.43)	73 (2.87)	102 (4.02)	102 (4.02)	16 (0.63)	3 (0.12)	282 (11.10)	23 (0.91)	6 (0.24)	26 (1.02)	6 (0.24)	134 (5.28)	233 (9.17)	M5
4018 *1	140 (5.51)	294 (11.57)	138 (5.43)	73 (2.87)	102 (4.02)	102 (4.02)	16 (0.63)	3 (0.12)	282 (11.10)	23 (0.91)	6 (0.24)	26 (1.02)	6 (0.24)	134 (5.28)	233 (9.17)	M5

Model	Dimensions mm (in)															
	W	H	D1	D2	W1	W2	W3	W4	H1	H2	H3	H4	H5	A	B	d1
4023 *1	140 (5.51)	294 (11.57)	138 (5.43)	73 (2.87)	102 (4.02)	102 (4.02)	16 (0.63)	3 (0.12)	282 (11.10)	23 (0.91)	6 (0.24)	26 (1.02)	6 (0.24)	134 (5.28)	233 (9.17)	M5
4031 *1	180 (7.09)	329 (12.95)	134 (5.28)	68 (2.68)	140 (5.51)	140 (5.51)	17 (0.67)	3 (0.12)	318 (12.52)	23.5 (0.93)	5 (0.20)	24.5 (0.97)	6 (0.24)	174 (6.85)	270 (10.63)	M5
4038 *1	180 (7.09)	329 (12.95)	134 (5.28)	68 (2.68)	140 (5.51)	140 (5.51)	17 (0.67)	3 (0.12)	318 (12.52)	23.5 (0.93)	5 (0.20)	24.5 (0.97)	6 (0.24)	174 (6.85)	270 (10.63)	M5
4044 *1	220 (8.66)	384 (15.12)	140 (5.51)	87 (3.43)	192 (7.56)	192 (7.56)	11 (0.43)	3 (0.12)	371 (14.61)	27 (1.06)	7 (0.28)	25 (0.98)	6 (0.24)	214 (8.43)	319 (12.56)	M6
4060 *1	220 (8.66)	384 (15.12)	140 (5.51)	106 (4.17)	192 (7.56)	192 (7.56)	11 (0.43)	3 (0.12)	371 (14.61)	27 (1.06)	7 (0.28)	25 (0.98)	6 (0.24)	214 (8.43)	319 (12.56)	M6
4075	240 (9.45)	400 (15.75)	166 (6.54)	114 (4.49)	195 (7.68)	204 (8.03)	14.5 (0.57)	8 (0.32)	385 (15.16)	19.5 (0.77)	7.5 (0.30)	19.5 (0.77)	7.5 (0.30)	224 (8.82)	346 (13.62)	M6
4089	255 (10.04)	450 (17.72)	166 (6.54)	114 (4.49)	170 (6.69)	210 (8.27)	34.5 (1.36)	8 (0.32)	436 (17.17)	20 (0.79)	8 (0.32)	20 (0.79)	6 (0.24)	239 (9.41)	396 (15.59)	M6
4103	255 (10.04)	450 (17.72)	166 (6.54)	114 (4.49)	170 (6.69)	210 (8.27)	34.5 (1.36)	8 (0.32)	436 (17.17)	20 (0.79)	8 (0.32)	20 (0.79)	6 (0.24)	239 (9.41)	396 (15.59)	M6
4140	264 (10.39)	543 (21.38)	186 (7.32)	149 (5.87)	190 (7.48)	220 (8.66)	29 (1.14)	8 (0.32)	527 (20.75)	19.5 (0.77)	8.5 (0.34)	20.5 (0.81)	7.5 (0.30)	248 (9.76)	487 (19.17)	M8
4168	264 (10.39)	543 (21.38)	186 (7.32)	149 (5.87)	190 (7.48)	220 (8.66)	29 (1.14)	8 (0.32)	527 (20.75)	19.5 (0.77)	8.5 (0.34)	20.5 (0.81)	7.5 (0.30)	248 (9.76)	487 (19.17)	M8
4208	312 (12.28)	700 (27.56)	260 (10.24)	160 (6.30)	218 (8.58)	263 (10.35)	39 (1.54)	8 (0.32)	675 (26.56)	33 (1.30)	12 (0.47)	32 (1.26)	13 (0.51)	296 (11.65)	610 (24.02)	M10
4250	312 (12.28)	700 (27.56)	260 (10.24)	160 (6.30)	218 (8.58)	263 (10.35)	39 (1.54)	8 (0.32)	675 (26.56)	33 (1.30)	12 (0.47)	32 (1.26)	13 (0.51)	296 (11.65)	610 (24.02)	M10
4302	312 (12.28)	700 (27.56)	260 (10.24)	160 (6.30)	218 (8.58)	263 (10.35)	39 (1.54)	8 (0.32)	675 (26.56)	33 (1.30)	12 (0.47)	32 (1.26)	13 (0.51)	296 (11.65)	610 (24.02)	M10
4371	440 (17.32)	800 (31.50)	254 (10.00)	218 (8.58)	370 (14.57)	310 (12.20)	23 (0.91)	12 (0.47)	773 (30.43)	31.5 (1.24)	14 (0.55)	31.5 (1.24)	13 (0.51)	416 (16.38)	710 (27.95)	M12
4414	440 (17.32)	800 (31.50)	254 (10.00)	218 (8.58)	370 (14.57)	310 (12.20)	23 (0.91)	12 (0.47)	773 (30.43)	31.5 (1.24)	14 (0.55)	31.5 (1.24)	13 (0.51)	416 (16.38)	710 (27.95)	M12

*1 The External Heatsink Installation Kit is necessary.

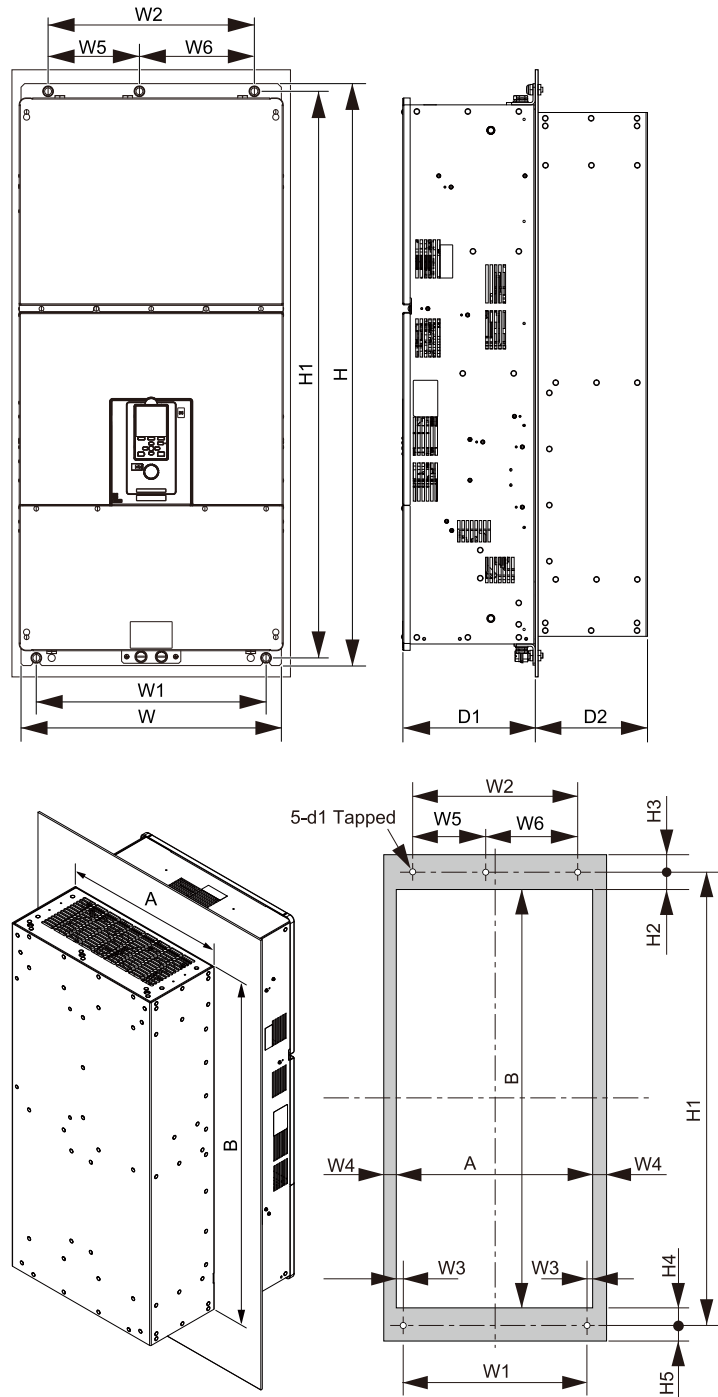

Figure 2.34 Panel Cut-Out Dimensions

Table 2.10 Panel Cut-out Dimensions (Models 4477 to 4720)

Model	Dimensions mm (in)																	
	W	H	D1	D2	W1	W2	W3	W4	W5	W6	H1	H2	H3	H4	H5	A	B	d1
4477	510 (20.08)	1140 (44.88)	260 (10.24)	220 (8.66)	450 (17.72)	404 (15.91)	18 (0.71)	12 (0.47)	179 (7.05)	225 (8.86)	1110 (43.70)	34 (1.34)	15 (0.59)	34 (1.34)	15 (0.59)	486 (19.13)	1042 (41.02)	M12
4568	510 (20.08)	1140 (44.88)	260 (10.24)	220 (8.66)	450 (17.72)	404 (15.91)	18 (0.71)	12 (0.47)	179 (7.05)	225 (8.86)	1110 (43.70)	34 (1.34)	15 (0.59)	34 (1.34)	15 (0.59)	486 (19.13)	1042 (41.02)	M12

Model	Dimensions mm (in)																	
	W	H	D1	D2	W1	W2	W3	W4	W5	W6	H1	H2	H3	H4	H5	A	B	d1
4605	510 (20.08)	1140 (44.88)	260 (10.24)	220 (8.66)	450 (17.72)	404 (15.91)	18 (0.71)	12 (0.47)	179 (7.05)	225 (8.86)	1110 (43.70)	34 (1.34)	15 (0.59)	34 (1.34)	15 (0.59)	486 (19.13)	1042 (41.02)	M12
4720	510 (20.08)	1140 (44.88)	260 (10.24)	220 (8.66)	450 (17.72)	404 (15.91)	18 (0.71)	12 (0.47)	179 (7.05)	225 (8.86)	1110 (43.70)	34 (1.34)	15 (0.59)	34 (1.34)	15 (0.59)	486 (19.13)	1042 (41.02)	M12

*1 The External Heatsink Installation Kit is necessary.

Electrical Installation

This chapter explains how to wire the control circuit terminals, motor, and power supply.

3.1	Section Safety	60
3.2	Electrical Installation	62
3.3	Main Circuit Wiring	65
3.4	Main Circuit Terminal Block Wiring Procedure	86
3.5	Control Circuit Wiring	92
3.6	Control I/O Connections	102
3.7	Connect the Drive to a PC	106
3.8	External Interlock	107
3.9	Braking Resistor Installation.....	108
3.10	Drive Wiring Protection	117
3.11	Dynamic Braking Option, Motor Protection	118
3.12	Improve the Power Factor	120
3.13	Prevent Switching Surge.....	121
3.14	Decrease Noise	122
3.15	Branch Circuit Protection	124
3.16	External EMC Noise Filter Selection.....	126
3.17	Wiring Checklist	128
3.18	Motor Application Precautions	130

3.1 Section Safety

DANGER

Electrical Shock Hazard

Do not examine, connect, or disconnect wiring on an energized drive. Before servicing, disconnect all power to the equipment and wait for the time specified on the warning label at a minimum. The internal capacitor stays charged after the drive is de-energized. The charge indicator LED extinguishes when the DC bus voltage decreases below 50 Vdc. When all indicators are OFF, remove the covers before measuring for dangerous voltages to make sure that the drive is safe.

If you do work on the drive when it is energized, it will cause serious injury or death from electrical shock. The drive has internal capacitors that stay charged after you de-energize the drive.

WARNING

Electrical Shock Hazard

Do not operate the drive when covers are missing. Replace covers and shields before you operate the drive. Use the drive only as specified by the instructions.

Some figures in this section include drives without covers or safety shields to more clearly show the inside of the drive. If covers or safety shields are missing from the drive, it can cause serious injury or death.

Make sure that the protective ground wire conforms to technical standards and local safety regulations. The IEC/EN 61800-5-1:2007 standard specifies that you must wire the power supply to automatically de-energize when the protective ground wire disconnects. You can also connect a protective ground wire that has a minimum cross-sectional area of 10 mm² (copper wire) or 16 mm² (aluminum wire).

If you do not obey the standards and regulations, it can cause serious injury or death. The leakage current of the drive will be more than 3.5 mA in drive models 4414 to 4720.

The drive can cause a residual current with a DC component in the protective earthing conductor. When a residual current operated protective or monitoring device prevents direct or indirect contact, always use a type B Ground Fault Circuit Interrupter (GFCI) as specified by IEC/EN 60755.

If you do not use the correct GFCI, it can cause serious injury or death.

Do not wear loose clothing or jewelry when you do work on the drive. Tighten loose clothing and remove all metal objects, for example watches or rings.

Loose clothing can catch on the drive and jewelry can conduct electricity and cause serious injury or death.

Do not remove covers or touch circuit boards while the drive is energized.

If you touch the internal components of an energized drive, it can cause serious injury or death.

Only let approved personnel install, wire, maintain, examine, replace parts, and repair the drive.

If personnel are not approved, it can cause serious injury or death.

Do not modify the drive body or drive circuitry.

Modifications to drive body and circuitry can cause serious injury or death, will cause damage to the drive, and will void the warranty. Yaskawa is not responsible for modifications of the product made by the user.

Fire Hazard

Tighten all terminal screws to the correct tightening torque.

Connections that are too loose or too tight can cause incorrect operation and damage to the drive. Incorrect connections can also cause death or serious injury from fire.

Tighten screws at an angle in the specified range shown in this manual.

If you tighten the screws at an angle not in the specified range, you can have loose connections that can cause damage to the terminal block or start a fire and cause serious injury or death.

⚠ WARNING**Damage to Equipment**

Do not apply incorrect voltage to the main circuit of the drive. Operate the drive in the specified range of the input voltage on the drive nameplate.

Voltages that are higher than the permitted nameplate tolerance can cause damage to the drive.

Fire Hazard

When you install a dynamic braking option, wire the components as specified by the wiring diagrams.

Incorrect wiring can cause damage to braking components or serious injury or death.

NOTICE

Do not let unwanted objects, for example metal shavings or wire clippings, fall into the drive during drive installation. Put a temporary cover over the drive during installation. Remove the temporary cover before start-up.

Unwanted objects inside of the drive can cause damage to the drive.

Damage to Equipment

When you touch the drive and circuit boards, make sure that you observe correct electrostatic discharge (ESD) procedures.

If you do not follow procedures, it can cause ESD damage to the drive circuitry.

Select a motor that is compatible with the load torque and speed range. When 100% continuous torque is necessary at low speed, use an inverter-duty motor or vector-duty motor. When you use a standard fan-cooled motor, decrease the motor torque in the low-speed range.

If you operate a standard fan-cooled motor at low speed and high torque, it will decrease the cooling effects and can cause heat damage.

Obey the speed range specification of the motor as specified by the manufacturer. When you must operate the motor outside of its specifications, contact the motor manufacturer.

If you continuously operate oil-lubricated motors outside of the manufacturer specifications, it can cause damage to the motor bearings.

When the input voltage is 440 V or higher or the wiring distance is longer than 100 m (328 ft), make sure that the motor insulation voltage is sufficient or use an inverter-duty motor or vector-duty motor with reinforced insulation.

Motor winding and insulation failure can occur.

Before you connect a dynamic braking option to the drive, make sure that qualified personnel read and obey the Braking Unit and Braking Resistor Unit Installation Manual (TOBPC72060001).

If you do not read and obey the manual or if personnel are not qualified, it can cause damage to the drive and braking circuit.

Make sure that all connections are correct after you install the drive and connect peripheral devices.

Incorrect connections can cause damage to the drive.

Note:

- Torque characteristics differ compared to operating the motor directly from line power. The user should have a full understanding of the load torque characteristics for the application.
- The current rating of submersible motors is usually higher than the current rating of standard motors for a given motor power. Make sure that the rated output current of the drive is equal to or more than the current rating of the motor. If the motor wire length is longer than 100 m (328 ft), select the correct wire gauge to adjust for a loss in voltage and prevent a loss of motor torque.
- Do not use unshielded wire for control wiring. Use shielded, twisted-pair wires and ground the shield to the ground terminal of the drive. Unshielded wire can cause electrical interference and unsatisfactory system performance.

3.2 Electrical Installation

DANGER! *Electrical Shock Hazard. Do not examine, connect, or disconnect wiring on an energized drive. Before servicing, disconnect all power to the equipment and wait for the time specified on the warning label at a minimum. The internal capacitor stays charged after the drive is de-energized. The charge indicator LED extinguishes when the DC bus voltage decreases below 50 Vdc. When all indicators are OFF, remove the covers before measuring for dangerous voltages to make sure that the drive is safe. If you do work on the drive when it is energized, it will cause serious injury or death from electrical shock. The drive has internal capacitors that stay charged after you de-energize the drive.*

WARNING! *Electrical Shock Hazard. De-energize the drive and wait 5 minutes minimum until the Charge LED turns off. Remove the front cover and terminal cover to do work on wiring, circuit boards, and other parts. Use terminals for their correct function only. Incorrect wiring, incorrect ground connections, and incorrect repair of protective covers can cause death or serious injury.*

WARNING! *Electrical Shock Hazard. Use the terminals for the drive only for their intended purpose. Refer to the technical manual for more information about the I/O terminals. Wiring and grounding incorrectly or modifying the cover may damage the equipment or cause injury.*

◆ Standard Connection Diagram

Wire the drive as specified by [Figure 3.1](#).

WARNING! *Sudden Movement Hazard. Set the MFDI parameters before you close control circuit switches. Incorrect Run/Stop circuit sequence settings can cause serious injury or death from moving equipment.*

WARNING! *Sudden Movement Hazard. Correctly wire the start/stop and safety circuits before you energize the drive. If you momentarily close a digital input terminal, it can start a drive that is programmed for 3-Wire control and cause serious injury or death from moving equipment.*

WARNING! *Sudden Movement Hazard. When you use a 3-Wire sequence, set A1-03 = 3330 [Initialize Parameters = 3-Wire Initialization] and make sure that b1-17 = 0 [Run Command at Power Up = Disregard Existing RUN Command] (default). If you do not correctly set the drive parameters for 3-Wire operation before you energize the drive, the motor can suddenly rotate when you energize the drive.*

WARNING! *Sudden Movement Hazard. Check the I/O signals and the external sequences for the drive before you set the Application Preset function. When you set the Application Preset function (A1-06 ≠ 0), it changes the I/O terminal functions for the drive and it can cause equipment to operate unusually. This can cause serious injury or death.*

WARNING! *Fire Hazard. Install sufficient branch circuit short circuit protection as specified by applicable codes and this manual. The drive is suitable for circuits that supply not more than 100,000 RMS symmetrical amperes, 240 Vac maximum (200 V Class), 480 Vac maximum (400 V Class). Incorrect branch circuit short circuit protection can cause serious injury or death.*

NOTICE: *When the input voltage is 440 V or higher or the wiring distance is longer than 100 m (328 ft), make sure that the motor insulation voltage is sufficient or use an inverter-duty motor or vector-duty motor with reinforced insulation. Motor winding and insulation failure can occur.*

Note:

Do not connect the AC control circuit ground to the drive enclosure. Incorrect ground wiring can cause the control circuit to operate incorrectly.

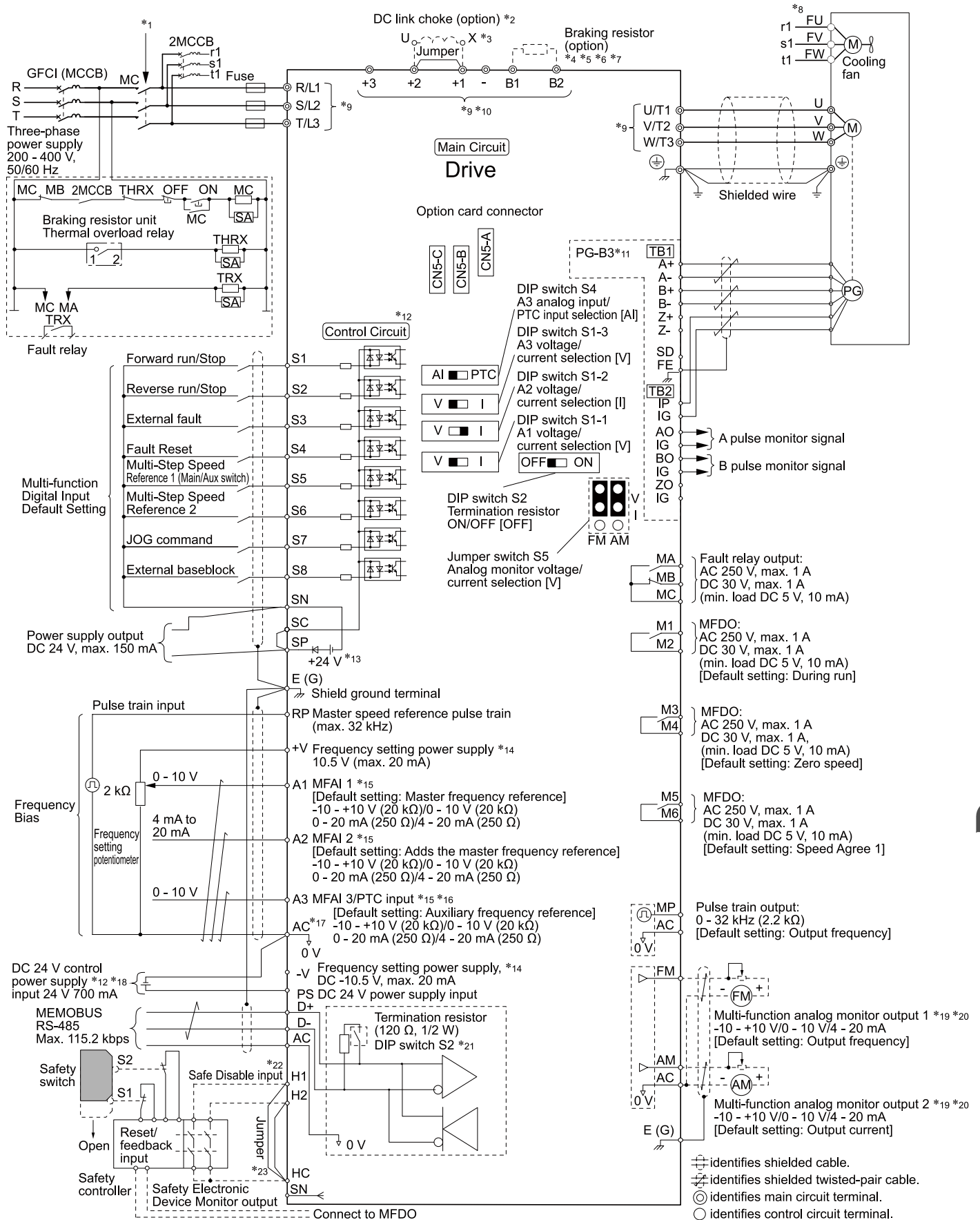

Figure 3.1 Standard Drive Connection Diagram

3.2 Electrical Installation

- *1 Set the wiring sequence to de-energize the drive with the fault relay output. If the drive outputs a fault during fault restart when you use the fault restart function, set $L5-02 = 1$ [*Fault Contact at Restart Select = Always Active*] to de-energize the drive. Be careful when you use a cut-off sequence. The default setting for $L5-02$ is 0 [*Active Only when Not Restarting*].
- *2 When you install a DC link choke, you must remove the jumper between terminals +1 and +2.
- *3 Models 2110 to 2415 and 4060 to 4720 have a DC link choke.
- *4 When you use a regenerative converter, regenerative unit, or braking unit, set $L8-55 = 0$ [*Internal DB Transistor Protection = Disable*]. If $L8-55 = 1$ [*Protection Enabled*], the drive will detect rF [*Braking Resistor Fault*].
- *5 When you use a regenerative converter, regenerative unit, braking unit, braking resistor, or braking resistor unit, set $L3-04 = 0$ [*Stall Prevention during Decel = Disabled*] If $L3-04 = 1$ [*General Purpose*], the drive could possibly not stop in the specified deceleration time.
- *6 When you use an ERF-type braking resistor, set $L8-01 = 1$ [*3% ERF DB Resistor Protection = Enabled*] and set a wiring sequence to de-energize the drive with the fault relay output.
- *7 When you connect a braking unit (CDBR series) or a braking resistor unit (LKEB series) to drive models 2110, 2138, and 4103, make sure that you use wires that are in the range of the applicable gauges for the drive. A junction terminal is necessary to connect wires that are less than the applicable gauge to the drive. Contact Yaskawa or your nearest sales representative for more information about selection and installation of the junction terminal.
- *8 Cooling fan wiring is not necessary for self-cooling motors.
- *9 The number of terminals is different for different models.
 - R/L1, S/L2, T/L3, U/T1, V/T2, W/T3: There are 2 screws for each terminal on models 4477 - 4720.
 - +3: Models 2169 - 2415 and 4208 - 4720 only. There are 2 screws for this terminal on models 4477 - 4720.
 - +2: Models 2004 - 2082 and 4002 - 4044 only.
 - +1, -: There are 2 screws for each terminal on models 2169, 2211, 4140, 4168, and 4477 - 4720.
 - B1, B2: Models 2004 - 2138 and 4002 - 4168 only.
- *10 Connect peripheral options to terminals -, +1, +2, B1, and B2.

WARNING! Fire Hazard. Only connect factory-recommended devices or circuits to drive terminals B1, B2, -, +1, +2, and +3 terminals. Do not connect AC power to these terminals. Incorrect wiring can cause damage to the drive and serious injury or death from fire.
- *11 Encoder circuit wiring (wiring to PG-B3 option) is not necessary for applications that do not use motor speed feedback.
- *12 Connect a 24 V power supply to terminals PS-AC to operate the control circuit while the main circuit power supply is OFF.
- *13 To set the MFDI power supply (Sinking/Sourcing Mode or internal/external power supply), install or remove a jumper between terminals SC-SP or SC-SN depending on the application.

NOTICE: Do not close the circuit between terminals SP-SN. A closed circuit between these terminals will cause damage to the drive.

 - Sinking Mode, Internal power supply: Install the jumper to close the circuit between terminals SC-SP.

NOTICE: Damage to Equipment. Do not close the circuit between terminals SC-SN. If you close the circuits terminals SC-SP and terminals SC-SN, it will cause damage to the drive.
 - Sourcing Mode, Internal power supply: Install the jumper to close the circuit between terminals SC-SN.

NOTICE: Damage to Equipment. Do not close the circuit between terminals SC-SP. If you close the circuits terminals SC-SP and terminals SC-SN, it will cause damage to the drive.
 - External power supply: Remove the jumper from the MFDI terminals. It is not necessary to close the circuit between terminals SC-SP and terminals SC-SN.
- *14 The maximum output current capacity for terminals +V and -V on the control circuit is 20 mA.

NOTICE: Do not install a jumper between terminals +V, -V, and AC. A closed circuit between these terminals will cause damage to the drive.
- *15 DIP switches S1-1 to S1-3 set terminals A1 to A3 for voltage or current input. The default setting for S1-1 and S1-3 is voltage input (“V” side). The default setting for S1-2 is current input (“I” side).
- *16 DIP switch S4 sets terminal A3 for analog or PTC input. Set DIP switch S1-3 to the “V” side, and set $H3-05 = 0$ [*Terminal A3 Signal Level Select = 0 to 10V (Lower Limit at 0)*] to set terminal A3 for PTC input with DIP switch S4.
- *17 Do not ground the control circuit terminals AC or connect them to the drive.

NOTICE: Do not ground the AC control circuit terminals and only connect the AC terminals according to the product instructions. If you connect the AC terminals incorrectly, it can cause damage to the drive.
- *18 Connect the positive lead from an external 24 Vdc power supply to terminal PS and the negative lead to terminal AC.

NOTICE: Connect terminals PS and AC correctly for the 24 V power supply. If you connect the wires to the incorrect terminals, it will cause damage to the drive.
- *19 Use multi-function analog monitor outputs with analog frequency meters, ammeters, voltmeters, and wattmeters. Do not use monitor outputs with feedback-type signal devices.
- *20 Jumper switch S5 sets terminal FM and AM for voltage or current output. The default setting for S5 is voltage output (“V” side).
- *21 Set DIP switch S2 to “ON” to enable the termination resistor in the last drive in a MEMOBUS/Modbus network.
- *22 Use only SOURCE Mode for Safe Disable input.
- *23 Disconnect the jumper between H1 and HC and H2 and HC to use the Safe Disable input.

3.3 Main Circuit Wiring

This section gives information about the functions, specifications, and procedures necessary to safely and correctly wire the main circuit in the drive.

NOTICE: Damage to Equipment. The drive can fail if users frequently turn the drive ON and OFF with the MC on the power source side to Run and Stop the drive. Incorrect operation can decrease the service life of the relay contacts and electrolytic capacitors. If you frequently use the magnetic contactor on the power source side to Run and Stop the drive, it can cause drive failure.

Note:

Soldered wire connections can become loose over time and cause unsatisfactory drive performance.

◆ Motor and Main Circuit Connections

WARNING! Electrical Shock Hazard. Do not connect terminals R/L1, S/L2, T/L3, U/T1, V/T2, W/T3, -, +1, +2, +3, B1, or B2 to the ground terminal. If you connect these terminals to earth ground, it can cause damage to the drive or serious injury or death.

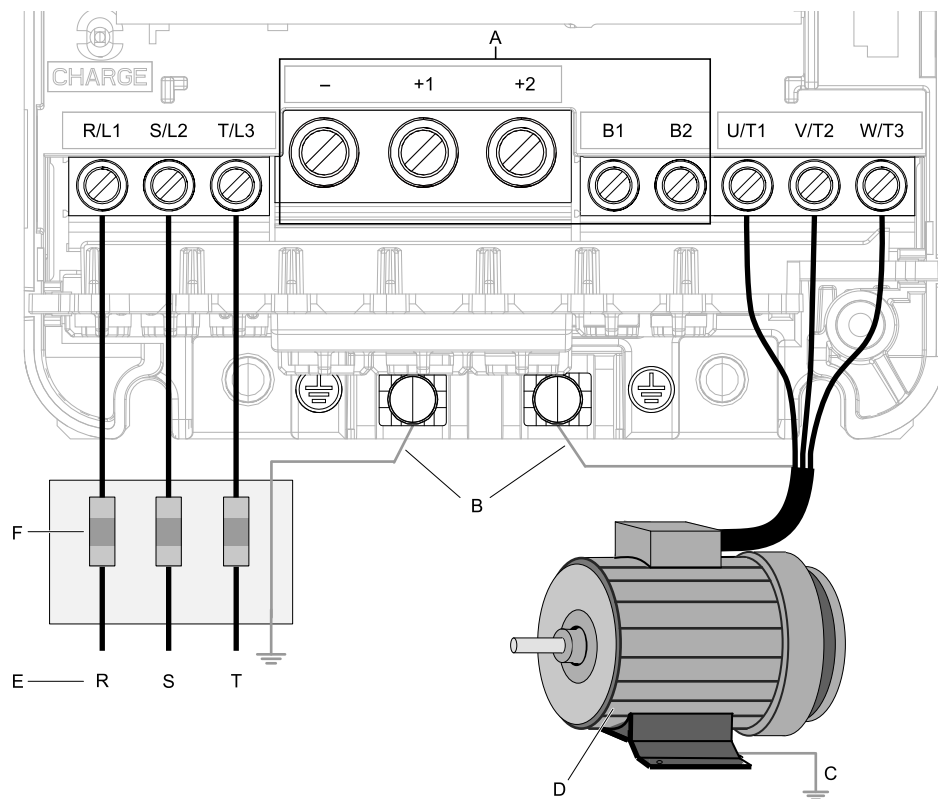

- A - DC bus terminal
- B - Connect to the drive ground terminal.
- C - Ground the motor case.
- D - Three-Phase Motor
- E - Use R, S, T for input power supply.
- F - Input Protection (Fuses or Circuit Breakers)

Note:

The location of terminals are different for different drive models.

Figure 3.2 Wiring the Main Circuit and Motor

◆ Configuration of Main Circuit Terminal Block

Use [Table 3.1](#) to find the correct main circuit terminal block figure for your drive.

Table 3.1 Configuration of Main Circuit Terminal Block

Model	Shape of Terminal ^{*/1}	Figure
2004 - 2042, 4002 - 4023	European terminal	Figure 3.3
2056, 4031, 4038	European terminal	Figure 3.4

3.3 Main Circuit Wiring

Model	Shape of Terminal ^{*1}	Figure
2070, 2082	European terminal	Figure 3.5
4044	European terminal	Figure 3.6
4060	European terminal	Figure 3.7
2110	European terminal	Figure 3.8
4075	European terminal	Figure 3.9
4089	European terminal	Figure 3.10
2138, 4103	European terminal	Figure 3.11
2169, 2211, 4140, 4168	European terminal	Figure 3.12
2257, 2313, 4208 - 4302	Screw terminal	Figure 3.13
2360, 2415, 4371, 4414	Screw terminal	Figure 3.14
4477 - 4720	Screw terminal	Figure 3.15

*1 The ground terminal is a screw terminal.

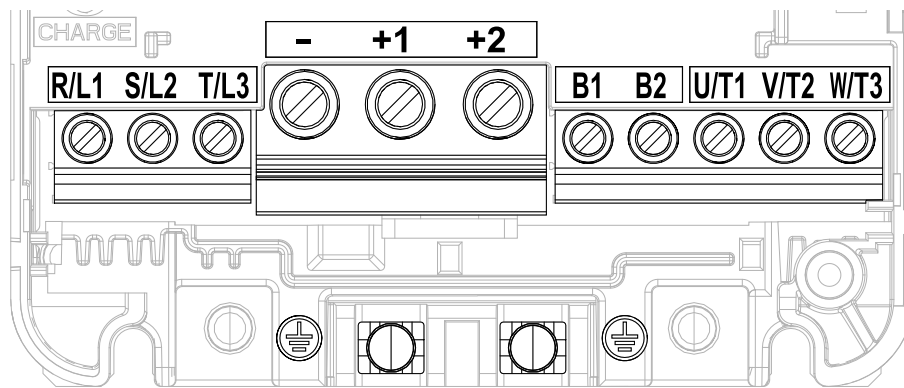

Figure 3.3 Configuration of Main Circuit Terminal Block (2004 - 2042, 4002 - 4023)

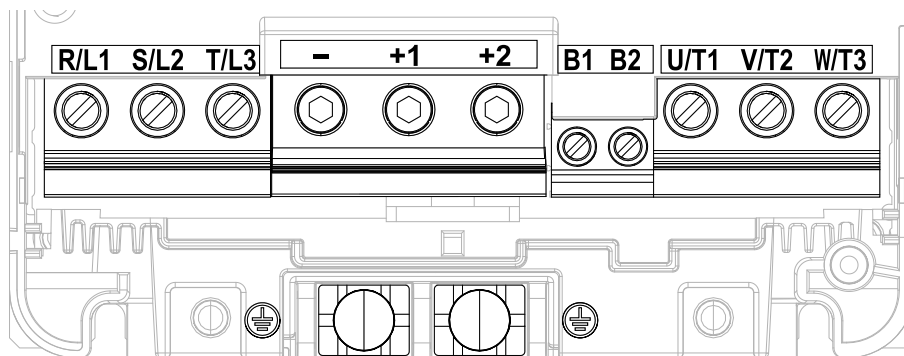

Figure 3.4 Configuration of Main Circuit Terminal Block (2056, 4031, 4038)

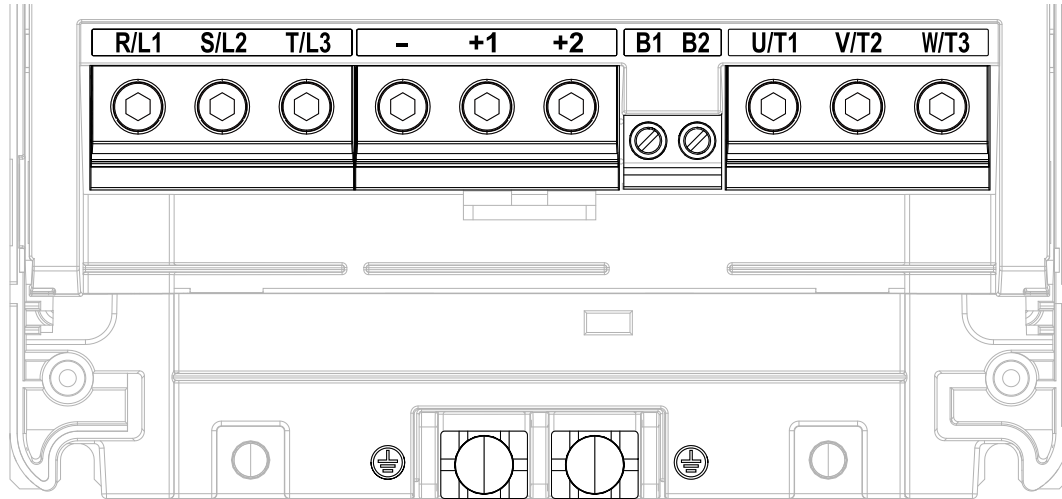

Figure 3.5 Configuration of Main Circuit Terminal Block (2070, 2082)

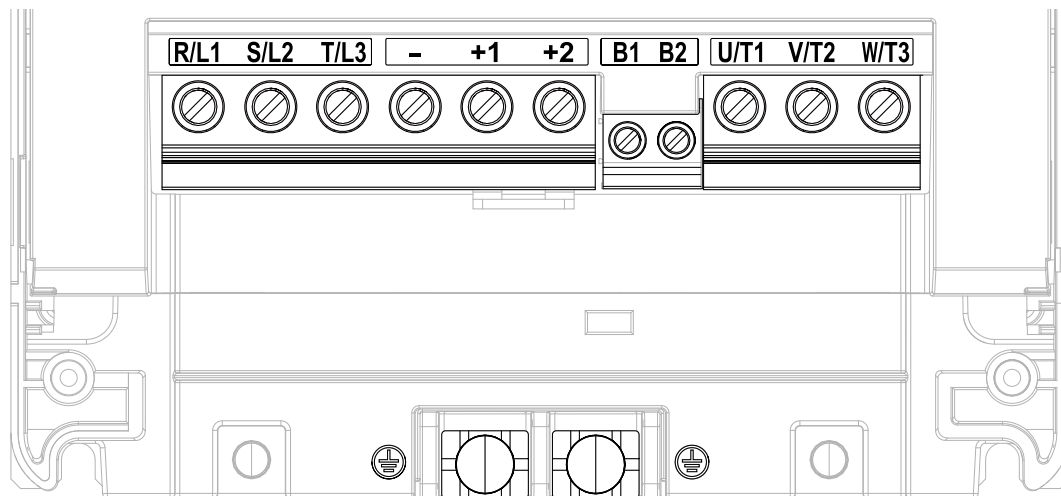

Figure 3.6 Configuration of Main Circuit Terminal Block (4044)

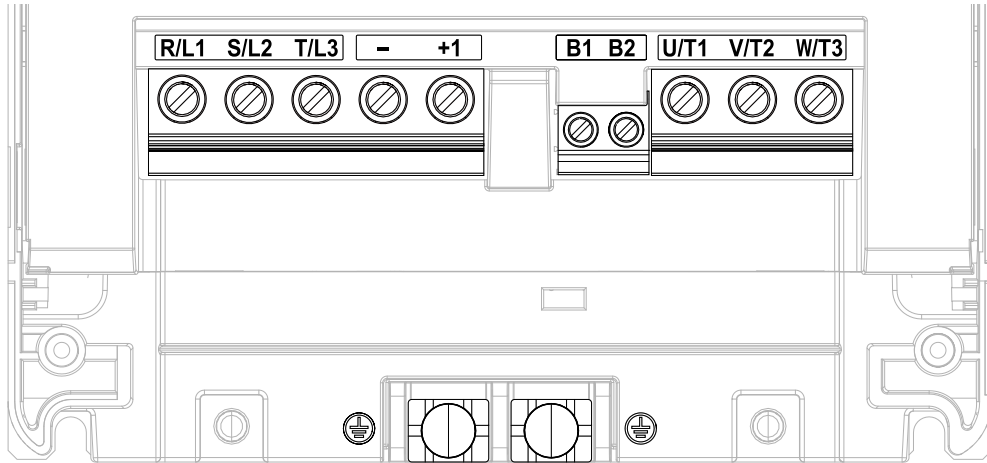

Figure 3.7 Configuration of Main Circuit Terminal Block (4060)

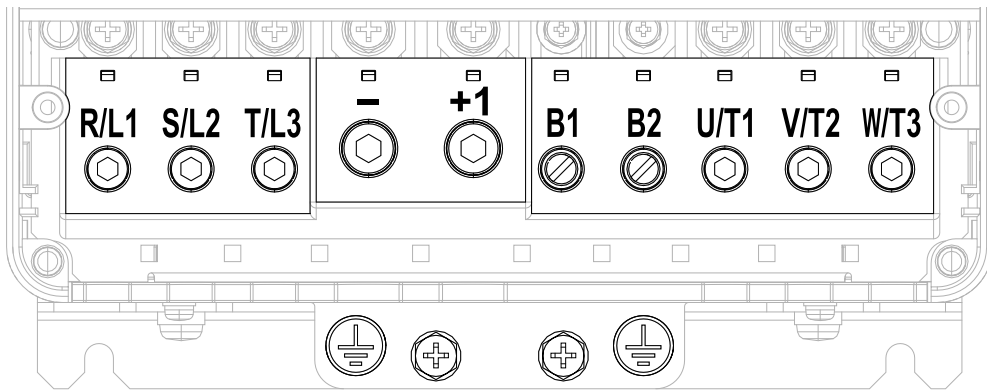

Figure 3.8 Configuration of Main Circuit Terminal Block (2110)

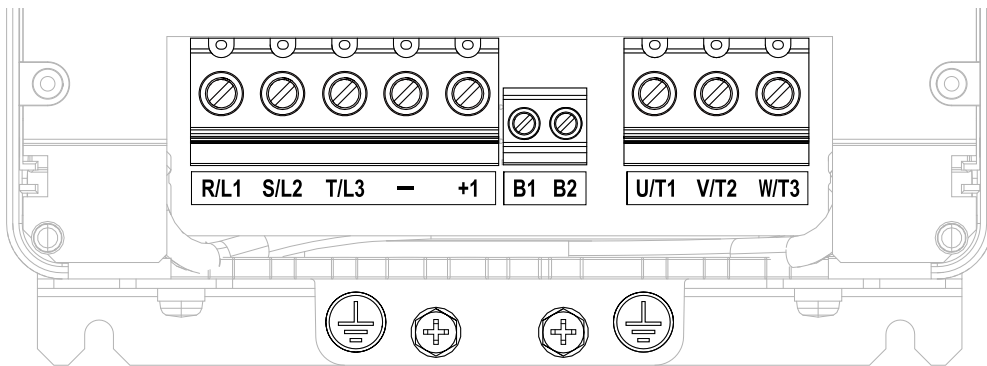

Figure 3.9 Configuration of Main Circuit Terminal Block (4075)

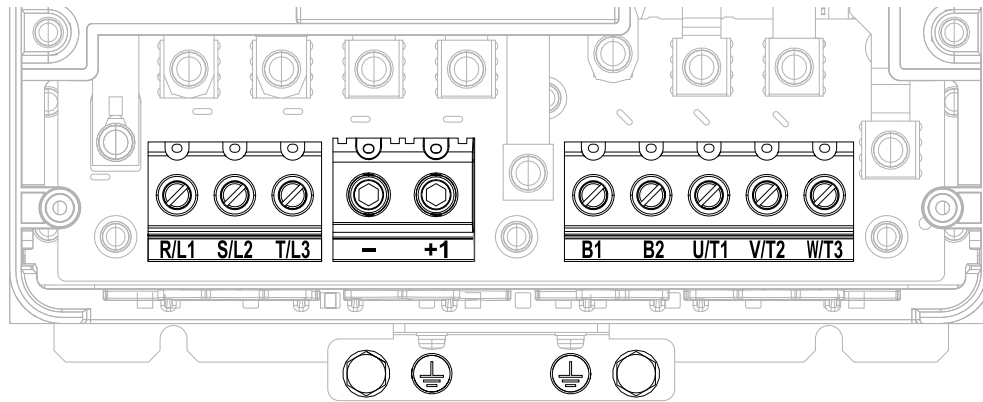

Figure 3.10 Configuration of Main Circuit Terminal Block (4089)

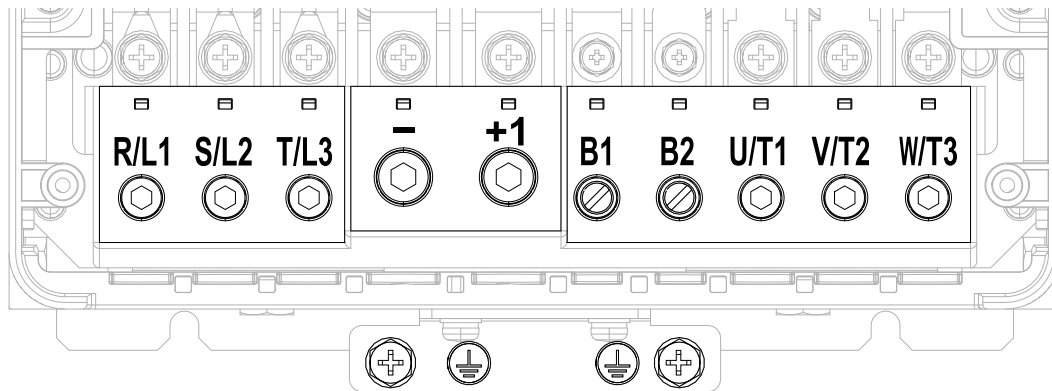

Figure 3.11 Configuration of Main Circuit Terminal Block (2138, 4103)

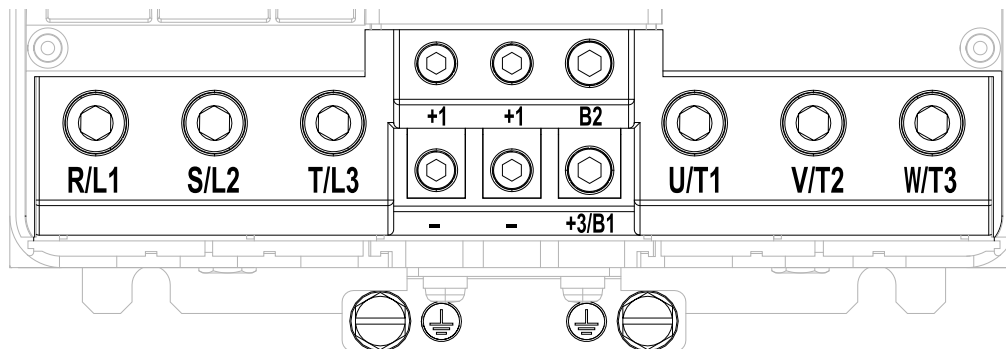

Figure 3.12 Configuration of Main Circuit Terminal Block (2169, 2211, 4140, 4168)

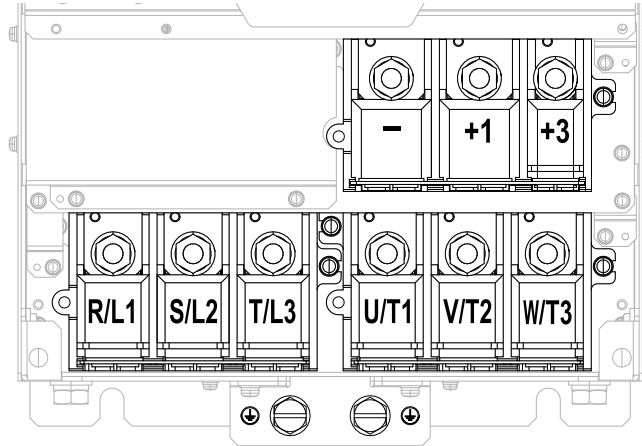

Figure 3.13 Configuration of Main Circuit Terminal Block (2257, 2313, 4208 - 4302)

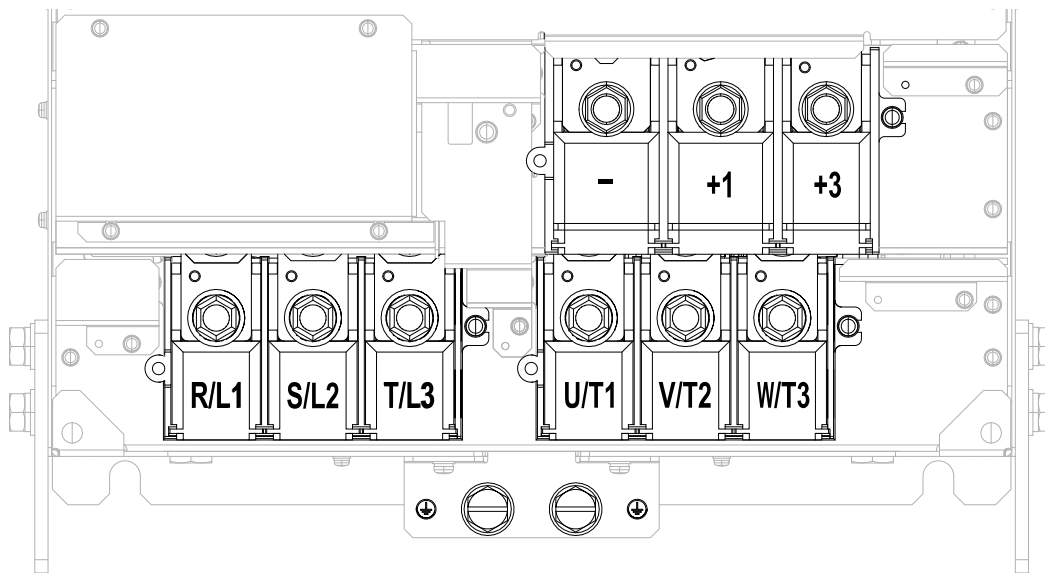

Figure 3.14 Configuration of Main Circuit Terminal Block (2360, 2415, 4371, 4414)

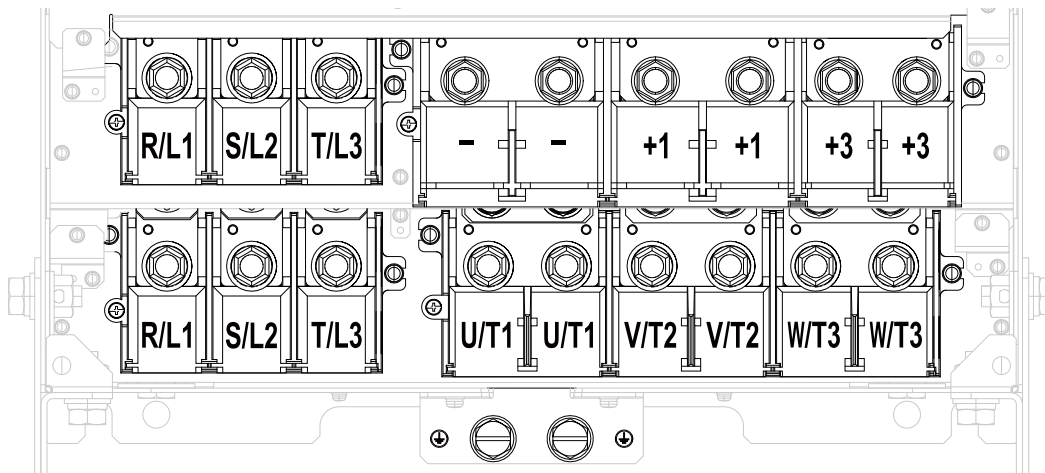



Figure 3.15 Configuration of Main Circuit Terminal Block (4477 - 4720)

◆ Main Circuit Terminal Functions

Refer to [Table 3.2](#) for the functions of drive main circuit terminals.

Table 3.2 Main Circuit Terminal Functions

Terminal	Name				Function
	2004 - 2082	2110 - 2138	2169 - 2415	-	
Model	4002 - 4044	4060 - 4168	4208 - 4414	4477 - 4720	
	R/L1	Main circuit power supply input			
S/L2					
T/L3					
U/T1	Drive output				To connect a motor.
V/T2					
W/T3					
B1	Braking resistor connection		-		To connect a braking resistor or braking resistor unit.
B2					
+2	<ul style="list-style-type: none"> DC power supply input (+1 and -) DC reactor connection (+1 and +2) 	-		To connect peripheral devices, for example: <ul style="list-style-type: none"> DC power input Braking unit DC link choke Note: Remove the jumper between terminals +1 and +2 to connect a DC link choke.	
+1					
-					
+3	-		<ul style="list-style-type: none"> DC power supply input (+1 and -) Braking unit connection (+3 and -) 		
	<ul style="list-style-type: none"> 200 V: D class grounding (ground to 100 Ω or less) 400 V: C class grounding (ground to 10 Ω or less) 				To ground the drive.

Note:

Use terminals B1 and - to connect a CDBR-type control unit to drive models 2004 to 2138 and 4002 to 4168 that have built-in braking transistors.

◆ Wire Selection

Select the correct wires for main circuit wiring.

Refer to [Main Circuit Wire Gauges and Tightening Torques on page 216](#) for wire gauges and tightening torques as specified by European standards.

Refer to [Wire Gauge and Torque Specifications for UL Listing on page 72](#) for wire gauges and tightening torques as specified by UL standards.

■ Wire Selection Precautions

WARNING! Electrical Shock Hazard. Make sure that the protective ground wire conforms to technical standards and local safety regulations. The IEC/EN 61800-5-1:2007 standard specifies that you must wire the power supply to automatically de-energize when the protective ground wire disconnects. You can also connect a protective ground wire that has a minimum cross-sectional area of 10 mm² (copper wire) or 16 mm² (aluminum wire). If you do not obey the standards and regulations, it can cause serious injury or death. The leakage current of the drive will be more than 3.5 mA in drive models 4414 to 4720.

Think about line voltage drop before selecting wire gauges. Select wire gauges that drop the voltage by 2% or less of the rated voltage. Increase the wire gauge and the cable length when the risk of voltage drops increases. Calculate line voltage drop with this formula:

Line voltage drop (V) = $\sqrt{3} \times$ wire resistance (Ω/km) \times wiring distance (m) \times motor rated current (A) $\times 10^{-3}$.

■ Precautions during Wiring

- Use terminals B1 and - to connect braking units to drives that have built-in braking transistors (models 2004 to 2138 and 4002 to 4168). Use terminals +3 and - to connect braking units to drives that do not have built-in braking transistors.

3.3 Main Circuit Wiring

- Refer to “Yaskawa AC Drive Option Braking Unit, Braking Resistor Unit Instruction Manual (TOBPC72060001)” for information about wire gauges and tightening torques to connect braking resistor units or braking units.
- Use terminals +1 and - to connect a regenerative converter or regenerative unit.

WARNING! Fire Hazard. Do not connect a braking resistor to terminals +1 or -. Use terminals B1 and B2 for the braking resistor connections. If you connect a braking resistor to the incorrect terminals, it can cause damage to the drive and braking circuit and serious injury or death.

■ Wire Gauge and Torque Specifications for UL Listing

WARNING! Electrical Shock Hazard. Make sure that the protective ground wire conforms to technical standards and local safety regulations. The IEC/EN 61800-5-1:2007 standard specifies that you must wire the power supply to automatically de-energize when the protective ground wire disconnects. You can also connect a protective ground wire that has a minimum cross-sectional area of 10 mm² (copper wire) or 16 mm² (aluminum wire). If you do not obey the standards and regulations, it can cause serious injury or death. The leakage current of the drive will be more than 3.5 mA in drive models 4414 to 4720.

Refer to [Three-Phase 200 V Class on page 72](#) and [Three-Phase 400 V Class on page 77](#) for the recommended wire gauges and tightening torques of the main circuit terminals.

Note:

- The recommended wire gauges are based on drive continuous current ratings with 75 °C (167 °F) 600 V class 2 heat-resistant indoor PVC wire. Assume these conditions:
 - Ambient temperature: 40 °C (104 °F) or lower
 - Wiring distance: 100 m (3281 ft) or shorter
 - Normal Duty Rated current value
- Use terminals +1, +2, +3, -, B1, and B2 to connect a peripheral option such as a DC link choke or a braking resistor. Do not connect other items to these terminals.
- Refer to the instruction manual for each device for recommended wire gauges to connect peripheral devices or options to terminals +1, +2, +3, -, B1, and B2. Contact Yaskawa or your nearest sales representative if the recommended wire gauges for the peripheral devices or options are out of the range of the applicable gauges for the drive.

Three-Phase 200 V Class

Model	Terminals	Recommended Gauge AWG, kcmil	Applicable Gauge (IP20 Applicable Gauge ^{*1}) AWG, kcmil	Wire Stripping Length ^{*2} mm	Terminal Screw		Tightening Torque N·m (in·lb)
					Size	Shape	
2004	R/L1, S/L2, T/L3	14	14 - 6 (14 - 6)	10	M4	Slotted (-)	1.5 - 1.7 (13.5 - 15)
	U/T1, V/T2, W/T3	14	14 - 6 (14 - 6)	10	M4	Slotted (-)	1.5 - 1.7 (13.5 - 15)
	-, +1, +2	14	14 - 3 (14 - 3)	18	M5	Slotted (-)	2.3 - 2.5 (19.8 - 22) ^{*3}
	B1, B2	14	14 - 10 (14 - 10)	10	M4	Slotted (-)	1.5 - 1.7 (13.5 - 15)
	⊕	10	14 - 8 (-)	-	M4	Phillips/slotted combo	1.2 - 1.5 (10.6 - 13.3)
2006	R/L1, S/L2, T/L3	14	14 - 6 (14 - 6)	10	M4	Slotted (-)	1.5 - 1.7 (13.5 - 15)
	U/T1, V/T2, W/T3	14	14 - 6 (14 - 6)	10	M4	Slotted (-)	1.5 - 1.7 (13.5 - 15)
	-, +1, +2	14	14 - 3 (14 - 3)	18	M5	Slotted (-)	2.3 - 2.5 (19.8 - 22) ^{*3}
	B1, B2	14	14 - 10 (14 - 10)	10	M4	Slotted (-)	1.5 - 1.7 (13.5 - 15)
	⊕	10	14 - 8 (-)	-	M4	Phillips/slotted combo	1.2 - 1.5 (10.6 - 13.3)

Model	Terminals	Recommended Gauge AWG, kcmil	Applicable Gauge (IP20 Applicable Gauge ^{*1}) AWG, kcmil	Wire Stripping Length ^{*2} mm	Terminal Screw		Tightening Torque N-m (in-lb)
					Size	Shape	
2008	R/L1, S/L2, T/L3	14	14 - 6 (14 - 6)	10	M4	Slotted (-)	1.5 - 1.7 (13.5 - 15)
	U/T1, V/T2, W/T3	14	14 - 6 (14 - 6)	10	M4	Slotted (-)	1.5 - 1.7 (13.5 - 15)
	-, +1, +2	14	14 - 3 (14 - 3)	18	M5	Slotted (-)	2.3 - 2.5 (19.8 - 22) ^{*3}
	B1, B2	14	14 - 10 (14 - 10)	10	M4	Slotted (-)	1.5 - 1.7 (13.5 - 15)
	⊕	10	14 - 8 (-)	-	M4	Phillips/slotted combo	1.2 - 1.5 (10.6 - 13.3)
2010	R/L1, S/L2, T/L3	12	14 - 6 (14 - 6)	10	M4	Slotted (-)	1.5 - 1.7 (13.5 - 15)
	U/T1, V/T2, W/T3	14	14 - 6 (14 - 6)	10	M4	Slotted (-)	1.5 - 1.7 (13.5 - 15)
	-, +1, +2	12	14 - 3 (14 - 3)	18	M5	Slotted (-)	2.3 - 2.5 (19.8 - 22) ^{*3}
	B1, B2	14	14 - 10 (14 - 10)	10	M4	Slotted (-)	1.5 - 1.7 (13.5 - 15)
	⊕	10	14 - 8 (-)	-	M4	Phillips/slotted combo	1.2 - 1.5 (10.6 - 13.3)
2012	R/L1, S/L2, T/L3	10	14 - 6 (14 - 6)	10	M4	Slotted (-)	1.5 - 1.7 (13.5 - 15)
	U/T1, V/T2, W/T3	12	14 - 6 (14 - 6)	10	M4	Slotted (-)	1.5 - 1.7 (13.5 - 15)
	-, +1, +2	10	14 - 3 (14 - 3)	18	M5	Slotted (-)	2.3 - 2.5 (19.8 - 22) ^{*3}
	B1, B2	14	14 - 10 (14 - 10)	10	M4	Slotted (-)	1.5 - 1.7 (13.5 - 15)
	⊕	10	14 - 8 (-)	-	M4	Phillips/slotted combo	1.2 - 1.5 (10.6 - 13.3)
2018	R/L1, S/L2, T/L3	10	14 - 6 (14 - 6)	10	M4	Slotted (-)	1.5 - 1.7 (13.5 - 15)
	U/T1, V/T2, W/T3	10	14 - 6 (14 - 6)	10	M4	Slotted (-)	1.5 - 1.7 (13.5 - 15)
	-, +1, +2	8	14 - 3 (14 - 3)	18	M5	Slotted (-)	2.3 - 2.5 (19.8 - 22) ^{*3}
	B1, B2	14	14 - 10 (14 - 10)	10	M4	Slotted (-)	1.5 - 1.7 (13.5 - 15)
	⊕	10	14 - 8 (-)	-	M4	Phillips/slotted combo	1.2 - 1.5 (10.6 - 13.3)
2021	R/L1, S/L2, T/L3	8	14 - 6 (14 - 6)	10	M4	Slotted (-)	1.5 - 1.7 (13.5 - 15)
	U/T1, V/T2, W/T3	10	14 - 6 (14 - 6)	10	M4	Slotted (-)	1.5 - 1.7 (13.5 - 15)
	-, +1, +2	8	14 - 3 (14 - 3)	18	M5	Slotted (-)	2.3 - 2.5 (19.8 - 22) ^{*3}
	B1, B2	14	14 - 10 (14 - 10)	10	M4	Slotted (-)	1.5 - 1.7 (13.5 - 15)
	⊕	10	12 - 8 (-)	-	M4	Phillips/slotted combo	1.2 - 1.5 (10.6 - 13.3)

3.3 Main Circuit Wiring

Model	Terminals	Recommended Gauge AWG, kcmil	Applicable Gauge (IP20 Applicable Gauge ^{*1}) AWG, kcmil	Wire Stripping Length ^{*2} mm	Terminal Screw		Tightening Torque N·m (in·lb)
					Size	Shape	
2030	R/L1, S/L2, T/L3	6	14 - 6 (14 - 6)	10	M4	Slotted (-)	1.5 - 1.7 (13.5 - 15)
	U/T1, V/T2, W/T3	8	14 - 6 (14 - 6)	10	M4	Slotted (-)	1.5 - 1.7 (13.5 - 15)
	-, +1, +2	6	14 - 3 (14 - 3)	18	M5	Slotted (-)	2.3 - 2.5 (19.8 - 22) ^{*3}
	B1, B2	12	14 - 10 (14 - 10)	10	M4	Slotted (-)	1.5 - 1.7 (13.5 - 15)
	⊕	8	10 - 8 (-)	-	M5	Phillips/slotted combo	2.0 - 2.5 (17.7 - 22.1)
2042	R/L1, S/L2, T/L3	6	14 - 6 (14 - 6)	10	M4	Slotted (-)	1.5 - 1.7 (13.5 - 15)
	U/T1, V/T2, W/T3	6	14 - 6 (14 - 6)	10	M4	Slotted (-)	1.5 - 1.7 (13.5 - 15)
	-, +1, +2	3	14 - 3 (14 - 3)	18	M5	Slotted (-)	2.3 - 2.5 (19.8 - 22) ^{*3}
	B1, B2	10	14 - 10 (14 - 10)	10	M4	Slotted (-)	1.5 - 1.7 (13.5 - 15)
	⊕	8	10 - 8 (-)	-	M5	Phillips/slotted combo	2.0 - 2.5 (17.7 - 22.1)
2056	R/L1, S/L2, T/L3	3	14 - 3 (8 - 3)	18	M5	Slotted (-)	2.3 - 2.5 (19.8 - 22) ^{*3}
	U/T1, V/T2, W/T3	4	14 - 4 (10 - 4)	18	M5	Slotted (-)	2.3 - 2.5 (19.8 - 22) ^{*3}
	-, +1, +2	1	14 - 1 (8 - 1)	20	M6	Hex socket cap (WAF: 5 mm)	5 - 5.5 (45 - 49)
	B1, B2	8	14 - 8 (14 - 8)	10	M4	Slotted (-)	1.5 - 1.7 (13.5 - 15)
	⊕	6	8 - 6 (-)	-	M6	Phillips/slotted combo	5.4 - 6.0 (47.8 - 53.1)
2070	R/L1, S/L2, T/L3	1	14 - 1 (6 - 1)	20	M6	Hex socket cap (WAF: 5 mm)	5 - 5.5 (45 - 49)
	U/T1, V/T2, W/T3	3	14 - 3 (6 - 3)	20	M6	Hex socket cap (WAF: 5 mm)	5 - 5.5 (45 - 49)
	-, +1, +2	1/0	14 - 1/0 (4 - 1/0)	20	M6	Hex socket cap (WAF: 5 mm)	5 - 5.5 (45 - 49)
	B1, B2	8	14 - 8 (14 - 8)	10	M4	Slotted (-)	1.5 - 1.7 (13.5 - 15)
	⊕	6	6 - 4 (-)	-	M6	Phillips/slotted combo	5.4 - 6.0 (47.8 - 53.1)
2082	R/L1, S/L2, T/L3	1/0	14 - 1/0 (6 - 1/0)	20	M6	Hex socket cap (WAF: 5 mm)	5 - 5.5 (45 - 49)
	U/T1, V/T2, W/T3	2	14 - 2 (6 - 2)	20	M6	Hex socket cap (WAF: 5 mm)	5 - 5.5 (45 - 49)
	-, +1, +2	2/0	14 - 2/0 (4 - 2/0)	20	M6	Hex socket cap (WAF: 5 mm)	5 - 5.5 (45 - 49)
	B1, B2	6	14 - 6 (14 - 6)	10	M4	Slotted (-)	1.5 - 1.7 (13.5 - 15)
	⊕	6	6 - 4 (-)	-	M6	Phillips/slotted combo	5.4 - 6.0 (47.8 - 53.1)

Model	Terminals	Recommended Gauge AWG, kcmil	Applicable Gauge (IP20 Applicable Gauge ^{*1}) AWG, kcmil	Wire Stripping Length ^{*2} mm	Terminal Screw		Tightening Torque N-m (in-lb)
					Size	Shape	
2110	R/L1, S/L2, T/L3	1/0	6 - 1/0 (6 - 1/0)	27	M6	Hex socket cap (WAF: 5 mm)	8 - 9 (71 - 80)
	U/T1, V/T2, W/T3	1/0	6 - 1/0 (6 - 1/0)	27	M6	Hex socket cap (WAF: 5 mm)	8 - 9 (71 - 80)
	-, +1	2/0	2 - 2/0 (2 - 2/0)	27	M8	Hex socket cap (WAF: 6 mm)	10 - 12 (89 - 107)
	B1, B2	4	14 - 4 (10 - 4)	21	M6	Slotted (-)	3 - 3.5 (27 - 31)
	⊕	6	6 - 4 (-)	-	M6	Hex bolt (+)	5.4 - 6.0 (47.8 - 53.1)
2138	R/L1, S/L2, T/L3	2/0	6 - 2/0 (2 - 2/0)	27	M6	Hex socket cap (WAF: 5 mm)	8 - 9 (71 - 80)
	U/T1, V/T2, W/T3	2/0	6 - 2/0 (2 - 2/0)	27	M6	Hex socket cap (WAF: 5 mm)	8 - 9 (71 - 80)
	-, +1	4/0	2 - 4/0 (2 - 4/0)	27	M8	Hex socket cap (WAF: 6 mm)	10 - 12 (89 - 107)
	B1, B2	3	14 - 3 (10 - 3)	21	M6	Slotted (-)	3 - 3.5 (27 - 31)
	⊕	4	4 (-)	-	M6	Hex bolt (+)	5.4 - 6.0 (47.8 - 53.1)
2169	R/L1, S/L2, T/L3	4/0	2 - 250 (2/0 - 250)	37	M10	Hex socket cap (WAF: 8 mm)	12 - 14 (107 - 124)
	U/T1, V/T2, W/T3	4/0	2 - 300 (3/0 - 300)	37	M10	Hex socket cap (WAF: 8 mm)	12 - 14 (107 - 124)
	-, -, +1, +1 ^{*4 *5}	1	6 - 2/0 (1/0 - 2/0)	28	M6	Hex socket cap (WAF: 5 mm)	8 - 9 (71 - 80)
	+3 ^{*5}	1/0	4 - 2/0 (1 - 2/0)	28	M8	Hex socket cap (WAF: 6 mm)	8 - 9 (71 - 80)
	⊕	4	4 - 1/0 (-)	-	M8	Hex bolt (slotted)	9.0 - 11 (79.7 - 97.4)
2211	R/L1, S/L2, T/L3	250	2 - 250 (2/0 - 250)	37	M10	Hex socket cap (WAF: 8 mm)	12 - 14 (107 - 124)
	U/T1, V/T2, W/T3	300	2 - 300 (3/0 - 300)	37	M10	Hex socket cap (WAF: 8 mm)	12 - 14 (107 - 124)
	-, -, +1, +1 ^{*4 *5}	2/0	6 - 2/0 (1/0 - 2/0)	28	M6	Hex socket cap (WAF: 5 mm)	8 - 9 (71 - 80)
	+3 ^{*5}	2/0	4 - 2/0 (1 - 2/0)	28	M8	Hex socket cap (WAF: 6 mm)	8 - 9 (71 - 80)
	⊕	4	4 - 1/0 (-)	-	M8	Hex bolt (slotted)	9.0 - 11 (79.7 - 97.4)
2257	R/L1, S/L2, T/L3	2/0 × 2P	3 - 4/0 × 2P (2/0 - 4/0 × 2P)	-	M10	Hex self-locking nut	20 (177)
	U/T1, V/T2, W/T3	2/0 × 2P	3 - 4/0 × 2P (2/0 - 4/0 × 2P)	-	M10	Hex self-locking nut	20 (177)
	-, +1	4/0 × 2P	2 - 250 × 2P (4/0 - 250 × 2P)	-	M10	Hex self-locking nut	20 (177)
	+3	1/0 × 2P	4 - 1/0 × 2P (1/0 × 2P)	-	M10	Hex self-locking nut	20 (177)
	⊕	3	3 - 350 (-)	-	M10	Hex bolt (slotted)	18 - 23 (159 - 204)

3.3 Main Circuit Wiring

Model	Terminals	Recommended Gauge AWG, kcmil	Applicable Gauge (IP20 Applicable Gauge ^{*1}) AWG, kcmil	Wire Stripping Length ^{*2} mm	Terminal Screw		Tightening Torque N·m (in·lb)
					Size	Shape	
2313	R/L1, S/L2, T/L3	4/0 × 2P	3 - 4/0 × 2P (2/0 - 4/0 × 2P)	-	M10	Hex self-locking nut	20 (177)
	U/T1, V/T2, W/T3	3/0 × 2P	3 - 4/0 × 2P (2/0 - 4/0 × 2P)	-	M10	Hex self-locking nut	20 (177)
	-, +1	250 × 2P	2 - 250 × 2P (4/0 - 250 × 2P)	-	M10	Hex self-locking nut	20 (177)
	+3	1/0 × 2P	4 - 1/0 × 2P (1/0 × 2P)	-	M10	Hex self-locking nut	20 (177)
	⊕	2	2 - 350 (-)	-	M10	Hex bolt (slotted)	18 - 23 (159 - 204)
2360	R/L1, S/L2, T/L3	250 × 2P	2/0 - 300 × 2P (250 - 300 × 2P)	-	M12	Hex self-locking nut	35 (310)
	U/T1, V/T2, W/T3	250 × 2P	2/0 - 300 × 2P (250 - 300 × 2P)	-	M12	Hex self-locking nut	35 (310)
	-, +1	350 × 2P	4/0 - 400 × 2P (300 - 400 × 2P)	-	M12	Hex self-locking nut	35 (310)
	+3	3/0 × 2P	1/0 - 4/0 × 2P (-)	-	M12	Hex self-locking nut	35 (310)
	⊕	1	1 - 350 (-)	-	M12	Hex bolt (slotted)	32 - 40 (283 - 354)
2415	R/L1, S/L2, T/L3	250 × 2P	2/0 - 300 × 2P (250 - 300 × 2P)	-	M12	Hex self-locking nut	35 (310)
	U/T1, V/T2, W/T3	300 × 2P	2/0 - 300 × 2P (250 - 300 × 2P)	-	M12	Hex self-locking nut	35 (310)
	-, +1	350 × 2P	4/0 - 400 × 2P (300 - 400 × 2P)	-	M12	Hex self-locking nut	35 (310)
	+3	3/0 × 2P	1/0 - 4/0 × 2P (-)	-	M12	Hex self-locking nut	35 (310)
	⊕	1	1 - 350 (-)	-	M12	Hex bolt (slotted)	32 - 40 (283 - 354)

- *1 For IP20 protection, use wires that are in the range of applicable gauges.
- *2 Remove insulation from the ends of wires to expose the length of wire shown.
- *3 For wire gauges more than AWG 8, tighten to a tightening torque of 4.1 N·m to 4.5 N·m (36 in·lb to 40 in·lb).
- *4 Terminals - and +1 have two screws. The Recommended Gauge is the wire gauge for one terminal.
- *5 A junction terminal is necessary to connect a braking unit (CDBR-series) to terminals - and +3.

Three-Phase 400 V Class

Model	Terminal	Recommended Gauge AWG, kcmil	Applicable Gauge (IP20 Applicable Gauge *) AWG, kcmil	Wire Stripping Length *2 mm	Terminal Screw		Tightening Torque N·m (in·lb)
					Size	Shape	
4002	R/L1, S/L2, T/L3	14	14 - 6 (14 - 6)	10	M4	Slotted (-)	1.5 - 1.7 (13.5 - 15)
	U/T1, V/T2, W/T3	14	14 - 6 (14 - 6)	10	M4	Slotted (-)	1.5 - 1.7 (13.5 - 15)
	-, +1, +2	14	14 - 3 (14 - 3)	18	M5	Slotted (-)	2.3 - 2.5 (19.8 - 22) *3
	B1, B2	14	14 - 10 (14 - 10)	10	M4	Slotted (-)	1.5 - 1.7 (13.5 - 15)
	⊕	12	14 - 8 (-)	-	M4	Phillips/slotted combo	1.2 - 1.5 (10.6 - 13.3)
4004	R/L1, S/L2, T/L3	14	14 - 6 (14 - 6)	10	M4	Slotted (-)	1.5 - 1.7 (13.5 - 15)
	U/T1, V/T2, W/T3	14	14 - 6 (14 - 6)	10	M4	Slotted (-)	1.5 - 1.7 (13.5 - 15)
	-, +1, +2	14	14 - 3 (14 - 3)	18	M5	Slotted (-)	2.3 - 2.5 (19.8 - 22) *3
	B1, B2	14	14 - 10 (14 - 10)	10	M4	Slotted (-)	1.5 - 1.7 (13.5 - 15)
	⊕	12	14 - 8 (-)	-	M4	Phillips/slotted combo	1.2 - 1.5 (10.6 - 13.3)
4005	R/L1, S/L2, T/L3	14	14 - 6 (14 - 6)	10	M4	Slotted (-)	1.5 - 1.7 (13.5 - 15)
	U/T1, V/T2, W/T3	14	14 - 6 (14 - 6)	10	M4	Slotted (-)	1.5 - 1.7 (13.5 - 15)
	-, +1, +2	14	14 - 3 (14 - 3)	18	M5	Slotted (-)	2.3 - 2.5 (19.8 - 22) *3
	B1, B2	14	14 - 10 (14 - 10)	10	M4	Slotted (-)	1.5 - 1.7 (13.5 - 15)
	⊕	10	14 - 8 (-)	-	M4	Phillips/slotted combo	1.2 - 1.5 (10.6 - 13.3)
4007	R/L1, S/L2, T/L3	14	14 - 6 (14 - 6)	10	M4	Slotted (-)	1.5 - 1.7 (13.5 - 15)
	U/T1, V/T2, W/T3	14	14 - 6 (14 - 6)	10	M4	Slotted (-)	1.5 - 1.7 (13.5 - 15)
	-, +1, +2	14	14 - 3 (14 - 3)	18	M5	Slotted (-)	2.3 - 2.5 (19.8 - 22) *3
	B1, B2	14	14 - 10 (14 - 10)	10	M4	Slotted (-)	1.5 - 1.7 (13.5 - 15)
	⊕	10	14 - 8 (-)	-	M4	Phillips/slotted combo	1.2 - 1.5 (10.6 - 13.3)
4009	R/L1, S/L2, T/L3	14	14 - 6 (14 - 6)	10	M4	Slotted (-)	1.5 - 1.7 (13.5 - 15)
	U/T1, V/T2, W/T3	14	14 - 6 (14 - 6)	10	M4	Slotted (-)	1.5 - 1.7 (13.5 - 15)
	-, +1, +2	12	14 - 3 (14 - 3)	18	M5	Slotted (-)	2.3 - 2.5 (19.8 - 22) *3
	B1, B2	14	14 - 10 (14 - 10)	10	M4	Slotted (-)	1.5 - 1.7 (13.5 - 15)
	⊕	10	14 - 8 (-)	-	M4	Phillips/slotted combo	1.2 - 1.5 (10.6 - 13.3)

3.3 Main Circuit Wiring

Model	Terminal	Recommended Gauge AWG, kcmil	Applicable Gauge (IP20 Applicable Gauge ^{*1}) AWG, kcmil	Wire Stripping Length ^{*2} mm	Terminal Screw		Tightening Torque N·m (in·lb)
					Size	Shape	
4012	R/L1, S/L2, T/L3	12	14 - 6 (14 - 6)	10	M4	Slotted (-)	1.5 - 1.7 (13.5 - 15)
	U/T1, V/T2, W/T3	14	14 - 6 (14 - 6)	10	M4	Slotted (-)	1.5 - 1.7 (13.5 - 15)
	-, +1, +2	10	14 - 3 (14 - 3)	18	M5	Slotted (-)	2.3 - 2.5 (19.8 - 22) ^{*3}
	B1, B2	14	14 - 10 (14 - 10)	10	M4	Slotted (-)	1.5 - 1.7 (13.5 - 15)
	⊕	10	14 - 8 (-)	-	M4	Phillips/slotted combo	1.2 - 1.5 (10.6 - 13.3)
4018	R/L1, S/L2, T/L3	10	14 - 6 (14 - 6)	10	M4	Slotted (-)	1.5 - 1.7 (13.5 - 15)
	U/T1, V/T2, W/T3	10	14 - 6 (14 - 6)	10	M4	Slotted (-)	1.5 - 1.7 (13.5 - 15)
	-, +1, +2	8	14 - 3 (14 - 3)	18	M5	Slotted (-)	2.3 - 2.5 (19.8 - 22) ^{*3}
	B1, B2	14	14 - 10 (14 - 10)	10	M4	Slotted (-)	1.5 - 1.7 (13.5 - 15)
	⊕	10	14 - 8 (-)	-	M5	Phillips/slotted combo	2.0 - 2.5 (17.7 - 22.1)
4023	R/L1, S/L2, T/L3	8	14 - 6 (14 - 6)	10	M4	Slotted (-)	1.5 - 1.7 (13.5 - 15)
	U/T1, V/T2, W/T3	10	14 - 6 (14 - 6)	10	M4	Slotted (-)	1.5 - 1.7 (13.5 - 15)
	-, +1, +2	8	14 - 3 (14 - 3)	18	M5	Slotted (-)	2.3 - 2.5 (19.8 - 22) ^{*3}
	B1, B2	12	14 - 10 (14 - 10)	10	M4	Slotted (-)	1.5 - 1.7 (13.5 - 15)
	⊕	10	12 - 8 (-)	-	M5	Phillips/slotted combo	2.0 - 2.5 (17.7 - 22.1)
4031	R/L1, S/L2, T/L3	6	14 - 3 (8 - 3)	18	M5	Slotted (-)	2.3 - 2.5 (19.8 - 22) ^{*3}
	U/T1, V/T2, W/T3	8	14 - 4 (10 - 4)	18	M5	Slotted (-)	2.3 - 2.5 (19.8 - 22) ^{*3}
	-, +1, +2	6	14 - 1 (8 - 1)	20	M6	Hex socket cap (WAF: 5 mm)	5 - 5.5 (45 - 49)
	B1, B2	10	14 - 8 (14 - 8)	10	M4	Slotted (-)	1.5 - 1.7 (13.5 - 15)
	⊕	8	10 - 6 (-)	-	M6	Phillips/slotted combo	5.4 - 6.0 (47.8 - 53.1)
4038	R/L1, S/L2, T/L3	6	14 - 3 (8 - 3)	18	M5	Slotted (-)	2.3 - 2.5 (19.8 - 22) ^{*3}
	U/T1, V/T2, W/T3	8	14 - 4 (10 - 4)	18	M5	Slotted (-)	2.3 - 2.5 (19.8 - 22) ^{*3}
	-, +1, +2	4	14 - 1 (8 - 1)	20	M6	Hex socket cap (WAF: 5 mm)	5 - 5.5 (45 - 49)
	B1, B2	10	14 - 8 (14 - 8)	10	M4	Slotted (-)	1.5 - 1.7 (13.5 - 15)
	⊕	6	10 - 6 (-)	-	M6	Phillips/slotted combo	5.4 - 6.0 (47.8 - 53.1)

Model	Terminal	Recommended Gauge AWG, kcmil	Applicable Gauge (IP20 Applicable Gauge *) AWG, kcmil	Wire Stripping Length *2 mm	Terminal Screw		Tightening Torque N·m (in·lb)
					Size	Shape	
4044	R/L1, S/L2, T/L3	4	14 - 4 (10 - 4)	18	M5	Slotted (-)	2.3 - 2.5 (19.8 - 22) *3
	U/T1, V/T2, W/T3	6	14 - 6 (10 - 6)	18	M5	Slotted (-)	2.3 - 2.5 (19.8 - 22) *3
	-, +1, +2	3	14 - 3 (10 - 3)	18	M5	Slotted (-)	2.3 - 2.5 (19.8 - 22) *3
	B1, B2	8	14 - 8 (14 - 8)	10	M4	Slotted (-)	1.5 - 1.7 (13.5 - 15)
	⊕	6	8 - 4 (-)	-	M6	Phillips/slotted combo	5.4 - 6.0 (47.8 - 53.1)
4060	R/L1, S/L2, T/L3	4	14 - 4 (10 - 4)	18	M5	Slotted (-)	2.3 - 2.5 (19.8 - 22) *3
	U/T1, V/T2, W/T3	4	14 - 4 (10 - 4)	18	M5	Slotted (-)	2.3 - 2.5 (19.8 - 22) *3
	-, +1	3	14 - 3 (10 - 3)	18	M5	Slotted (-)	2.3 - 2.5 (19.8 - 22) *3
	B1, B2	8	14 - 8 (14 - 8)	10	M4	Slotted (-)	1.5 - 1.7 (13.5 - 15)
	⊕	6	8 - 4 (-)	-	M6	Phillips/slotted combo	5.4 - 6.0 (47.8 - 53.1)
4075	R/L1, S/L2, T/L3	3	14 - 3 (12 - 3)	18	M5	Slotted (-)	2.3 - 2.5 (19.8 - 22) *3
	U/T1, V/T2, W/T3	3	14 - 3 (12 - 3)	18	M5	Slotted (-)	2.3 - 2.5 (19.8 - 22) *3
	-, +1	2	14 - 2 (10 - 2)	18	M5	Slotted (-)	2.3 - 2.5 (19.8 - 22) *3
	B1, B2	6	14 - 6 (14 - 6)	10	M4	Slotted (-)	1.5 - 1.7 (13.5 - 15)
	⊕	6	6 - 4 (-)	-	M6	Hex bolt (+)	5.4 - 6.0 (47.8 - 53.1)
4089	R/L1, S/L2, T/L3	2	14 - 2 (10 - 2)	18	M5	Slotted (-)	2.3 - 2.5 (19.8 - 22) *3
	U/T1, V/T2, W/T3	2	14 - 2 (10 - 2)	18	M5	Slotted (-)	2.3 - 2.5 (19.8 - 22) *3
	-, +1	1/0	14 - 1/0 (6 - 1/0)	20	M6	Hex socket cap (WAF: 5 mm)	5 - 5.5 (45 - 49)
	B1, B2	6	14 - 6 (14 - 6)	18	M5	Slotted (-)	2.3 - 2.5 (19.8 - 22) *3
	⊕	4	6 - 4 (-)	-	M6	Hex bolt (+)	5.4 - 6.0 (47.8 - 53.1)
4103	R/L1, S/L2, T/L3	1/0	6 - 2/0 (2 - 2/0)	27	M6	Hex socket cap (WAF: 5 mm)	8 - 9 (71 - 80)
	U/T1, V/T2, W/T3	1	6 - 2/0 (2 - 2/0)	27	M6	Hex socket cap (WAF: 5 mm)	8 - 9 (71 - 80)
	-, +1	2/0	2 - 4/0 (2 - 4/0)	27	M8	Hex socket cap (WAF: 6 mm)	10 - 12 (89 - 107)
	B1, B2	3	14 - 3 (10 - 3)	21	M6	Slotted (-)	3 - 3.5 (27 - 31)
	⊕	4	6 - 4 (-)	-	M6	Hex bolt (+)	5.4 - 6.0 (47.8 - 53.1)

3.3 Main Circuit Wiring

Model	Terminal	Recommended Gauge AWG, kcmil	Applicable Gauge (IP20 Applicable Gauge *1) AWG, kcmil	Wire Stripping Length *2 mm	Terminal Screw		Tightening Torque N·m (in·lb)
					Size	Shape	
4140	R/L1, S/L2, T/L3	3/0	2 - 250 (2/0 - 250)	37	M10	Hex socket cap (WAF: 8 mm)	12 - 14 (107 - 124)
	U/T1, V/T2, W/T3	2/0	2 - 300 (3/0 - 300)	37	M10	Hex socket cap (WAF: 8 mm)	12 - 14 (107 - 124)
	-, -, +1, +1 *4	2	6 - 2/0 (1/0 - 2/0)	28	M6	Hex socket cap (WAF: 5 mm)	8 - 9 (71 - 80)
	B1, B2 *5	1	4 - 2/0 (1 - 2/0)	28	M8	Hex socket cap (WAF: 6 mm)	8 - 9 (71 - 80)
	⊕	4	4 - 1/0 (-)	-	M8	Hex bolt (slotted)	9.0 - 11 (79.7 - 97.4)
4168	R/L1, S/L2, T/L3	4/0	2 - 250 (2/0 - 250)	37	M10	Hex socket cap (WAF: 8 mm)	12 - 14 (107 - 124)
	U/T1, V/T2, W/T3	4/0	2 - 300 (3/0 - 300)	37	M10	Hex socket cap (WAF: 8 mm)	12 - 14 (107 - 124)
	-, -, +1, +1 *4	1/0	6 - 2/0 (1/0 - 2/0)	28	M6	Hex socket cap (WAF: 5 mm)	8 - 9 (71 - 80)
	B1, B2 *5	1/0	4 - 2/0 (1 - 2/0)	28	M8	Hex socket cap (WAF: 6 mm)	8 - 9 (71 - 80)
	⊕	4	4 - 1/0 (-)	-	M8	Hex bolt (slotted)	9.0 - 11 (79.7 - 97.4)
4208	R/L1, S/L2, T/L3	1/0 × 2P	3 - 4/0 × 2P (2/0 - 4/0 × 2P)	-	M10	Hex self-locking nut	20 (177)
	U/T1, V/T2, W/T3	1/0 × 2P	3 - 4/0 × 2P (2/0 - 4/0 × 2P)	-	M10	Hex self-locking nut	20 (177)
	-, +1	3/0 × 2P	2 - 250 × 2P (4/0 - 250 × 2P)	-	M10	Hex self-locking nut	20 (177)
	+3	1/0 × 2P	4 - 1/0 × 2P (1/0 × 2P)	-	M10	Hex self-locking nut	20 (177)
	⊕	4	4 - 350 (-)	-	M10	Hex bolt (slotted)	18 - 23 (159 - 204)
4250	R/L1, S/L2, T/L3	2/0 × 2P	3 - 4/0 × 2P (2/0 - 4/0 × 2P)	-	M10	Hex self-locking nut	20 (177)
	U/T1, V/T2, W/T3	2/0 × 2P	3 - 4/0 × 2P (2/0 - 4/0 × 2P)	-	M10	Hex self-locking nut	20 (177)
	-, +1	3/0 × 2P	2 - 250 × 2P (4/0 - 250 × 2P)	-	M10	Hex self-locking nut	20 (177)
	+3	1/0 × 2P	4 - 1/0 × 2P (1/0 × 2P)	-	M10	Hex self-locking nut	20 (177)
	⊕	2	2 - 350 (-)	-	M10	Hex bolt (slotted)	18 - 23 (159 - 204)
4302	R/L1, S/L2, T/L3	3/0 × 2P	3 - 4/0 × 2P (2/0 - 4/0 × 2P)	-	M10	Hex self-locking nut	20 (177)
	U/T1, V/T2, W/T3	3/0 × 2P	3 - 4/0 × 2P (2/0 - 4/0 × 2P)	-	M10	Hex self-locking nut	20 (177)
	-, +1	4/0 × 2P	2 - 250 × 2P (4/0 - 250 × 2P)	-	M10	Hex self-locking nut	20 (177)
	+3	1/0 × 2P	4 - 1/0 × 2P (1/0 × 2P)	-	M10	Hex self-locking nut	20 (177)
	⊕	2	2 - 350 (-)	-	M10	Hex bolt (slotted)	18 - 23 (159 - 204)

Model	Terminal	Recommended Gauge AWG, kcmil	Applicable Gauge (IP20 Applicable Gauge *) AWG, kcmil	Wire Stripping Length *2 mm	Terminal Screw		Tightening Torque N·m (in·lb)
					Size	Shape	
4371	R/L1, S/L2, T/L3	250 × 2P	2/0 - 300 × 2P (250 - 300 × 2P)	-	M12	Hex self-locking nut	35 (310)
	U/T1, V/T2, W/T3	250 × 2P	2/0 - 300 × 2P (250 - 300 × 2P)	-	M12	Hex self-locking nut	35 (310)
	-, +1	350 × 2P	4/0 - 400 × 2P (300 - 400 × 2P)	-	M12	Hex self-locking nut	35 (310)
	+3	3/0 × 2P	1 - 4/0 × 2P (-)	-	M12	Hex self-locking nut	35 (310)
	⊕	1	1 - 350 (-)	-	M12	Hex bolt (slotted)	32 - 40 (283 - 354)
4414	R/L1, S/L2, T/L3	300 × 2P	2/0 - 300 × 2P (250 - 300 × 2P)	-	M12	Hex self-locking nut	35 (310)
	U/T1, V/T2, W/T3	300 × 2P	2/0 - 300 × 2P (250 - 300 × 2P)	-	M12	Hex self-locking nut	35 (310)
	-, +1	400 × 2P	4/0 - 400 × 2P (300 - 400 × 2P)	-	M12	Hex self-locking nut	35 (310)
	+3	4/0 × 2P	1 - 4/0 × 2P (-)	-	M12	Hex self-locking nut	35 (310)
	⊕	1	1 - 350 (-)	-	M12	Hex bolt (slotted)	32 - 40 (283 - 354)
4477	R/L1, S/L2, T/L3	250 × 4P	2/0 - 300 × 4P (250 - 300 × 4P)	-	M12	Hex self-locking nut	35 (310)
	U/T1, V/T2, W/T3	4/0 × 4P	2/0 - 300 × 4P (250 - 300 × 4P)	-	M12	Hex self-locking nut	35 (310)
	-, +1	4/0 × 4P	3/0 - 400 × 4P (300 - 400 × 4P)	-	M12	Hex self-locking nut	35 (310)
	+3	3/0 × 4P	2 - 4/0 (4/0 × 4P)	-	M12	Hex self-locking nut	35 (310)
	⊕	1/0	1/0 - 300 (-)	-	M12	Hex bolt (slotted)	32 - 40 (283 - 354)
4568	R/L1, S/L2, T/L3	250 × 4P	2/0 - 300 × 4P (250 - 300 × 4P)	-	M12	Hex self-locking nut	35 (310)
	U/T1, V/T2, W/T3	4/0 × 4P	2/0 - 300 × 4P (250 - 300 × 4P)	-	M12	Hex self-locking nut	35 (310)
	-, +1	300 × 4P	3/0 - 400 × 4P (300 - 400 × 4P)	-	M12	Hex self-locking nut	35 (310)
	+3	3/0 × 4P	2 - 4/0 × 4P (4/0 × 4P)	-	M12	Hex self-locking nut	35 (310)
	⊕	2/0	2/0 - 300 (-)	-	M12	Hex bolt (slotted)	32 - 40 (283 - 354)
4605	R/L1, S/L2, T/L3	300 × 4P	2/0 - 300 × 4P (250 - 300 × 4P)	-	M12	Hex self-locking nut	35 (310)
	U/T1, V/T2, W/T3	300 × 4P	2/0 - 300 × 4P (250 - 300 × 4P)	-	M12	Hex self-locking nut	35 (310)
	-, +1	400 × 4P	3/0 - 400 × 4P (300 - 400 × 4P)	-	M12	Hex self-locking nut	35 (310)
	+3	4/0 × 4P	2 - 4/0 × 4P (4/0 × 4P)	-	M12	Hex self-locking nut	35 (310)
	⊕	2/0	2/0 - 300 (-)	-	M12	Hex bolt (slotted)	32 - 40 (283 - 354)

3.3 Main Circuit Wiring

Model	Terminal	Recommended Gauge AWG, kcmil	Applicable Gauge (IP20 Applicable Gauge ^{*1}) AWG, kcmil	Wire Stripping Length ^{*2} mm	Terminal Screw		Tightening Torque N·m (in·lb)
					Size	Shape	
4720	R/L1, S/L2, T/L3	300 × 4P	2/0 - 300 × 4P (250 - 300 × 4P)	-	M12	Hex self-locking nut	35 (310)
	U/T1, V/T2, W/T3	300 × 4P	2/0 - 300 × 4P (250 - 300 × 4P)	-	M12	Hex self-locking nut	35 (310)
	-, +1	400 × 4P	3/0 - 400 × 4P (300 - 400 × 4P)	-	M12	Hex self-locking nut	35 (310)
	+3	4/0 × 4P	2 - 4/0 × 4P (4/0 × 4P)	-	M12	Hex self-locking nut	35 (310)
	⊕	2/0	2/0 - 300 (-)	-	M12	Hex bolt (slotted)	32 - 40 (283 - 354)

- *1 For IP20 protection, use wires that are in the range of applicable gauges.
- *2 Remove insulation from the ends of wires to expose the length of wire shown.
- *3 For wire gauges more than AWG 8, tighten to a tightening torque of 4.1 N·m to 4.5 N·m (36 in·lb to 40 in·lb).
- *4 Terminals - and +1 have two screws. The Recommended Gauge is the wire gauge for one terminal.
- *5 A junction terminal is necessary to connect a braking resistor unit (LKEB-series) to terminals B1 and B2.

◆ Main Circuit Terminal and Motor Wiring

This section outlines the various steps, precautions, and checkpoints for wiring the main circuit terminals and motor terminals.

WARNING! Fire Hazard. Do not connect main power supply wiring to drive motor terminals U/T1, V/T2, and W/T3. Connect main power supply wiring to main circuit input terminals R/L1, S/L2, and T/L3. Incorrect wiring can cause serious injury or death from fire.

WARNING! Sudden Movement Hazard. Make sure that you align the phase order for the drive and motor when you connect the motor to drive output terminals U/T1, V/T2, and W/T3. If the phase order is incorrect, it can cause the motor to run in reverse. If the motor accidentally runs in reverse, it can cause serious injury or death.

NOTICE: Do not connect phase-advancing capacitors, LC/RC noise filters, or leakage breakers (GFCI) to the motor circuit. If you connect these devices to the output circuits, it can cause damage to the drive and connected equipment.

■ Cable Length Between Drive and Motor

When the wiring between the drive and the motor is too long, voltage drop along the motor cable can decrease motor torque, usually at low frequency output. If you connect motors in parallel with long motor cable, this is also a problem. Drive output current increases when the leakage current from the cable increases. An increase in leakage current can cause overcurrent and decrease the precision of the current detection.

Use the values in [L8-27: Overcurrent Detection Gain on page 944](#) to adjust the drive carrier frequency. When the system configuration makes the motor wiring distance more than 100 m (328 ft), do not use metal conduits or use isolated cables for each phase to decrease stray capacitance.

Table 3.3 Carrier Frequency against Cable Length Between Drive and Motor

Wiring distance between the drive and motor	50 m (164 ft) maximum	100 m (328 ft) maximum	More than 100 m (328 ft)
Carrier Frequency	15 kHz or less	5 kHz or less	2 kHz or less

Note:

- To set the carrier frequency in a drive that is operating more than one motor, calculate the cable length as the total distance of wiring to all connected motors.
- IN OLV/PM and AOLV/PM [A1-02 = 5 and 6], the maximum cable length is 100 m (328 ft).
- When you connect to a PM motor, it can be necessary to adjust the overcurrent detection. For details, refer to [L8-27: Overcurrent Detection Gain on page 944](#).

■ Ground Wiring

Follow the precautions to wire the ground for one drive or a series of drives.

WARNING! Electrical Shock Hazard. Make sure that the protective ground wire conforms to technical standards and local safety regulations. The IEC/EN 61800-5-1:2007 standard specifies that you must wire the power supply to automatically de-energize when the protective ground wire disconnects. You can also connect a protective ground wire that has a minimum cross-sectional area of 10 mm² (copper wire) or 16 mm² (aluminum wire). If you do not obey the standards and regulations, it can cause serious injury or death. The leakage current of the drive will be more than 3.5 mA in drive models 4414 to 4720.

WARNING! Electrical Shock Hazard. Use a ground wire that complies with technical standards on electrical equipment and use the minimum length of ground wire. Incorrect equipment grounding can cause serious injury or death from dangerous electrical potentials on the equipment chassis.

WARNING! Electrical Shock Hazard.

Correctly ground the ground terminals. Obey federal and local electrical wiring codes for correct grounding methods. The maximum grounding resistance is

- 200 V class: ground to 100 Ω or less
- 400 V class: ground to 10 Ω or less

If you touch electrical equipment that is not grounded, it can cause serious injury or death.

Note:

- Do not use the drive grounding wire for any other purposes than grounding the drive. Do not share the ground wire with other devices such as welding machines or large-current electrical equipment. Incorrect equipment grounding can cause incorrect operation of drives and equipment.
- To connect multiple drives to the same grounding circuit, follow the instructions in the instruction manual. Incorrect equipment grounding can cause incorrect operation of drives and equipment.

Refer to [Figure 3.16](#) when installing multiple drives. Do not loop the grounding wire.

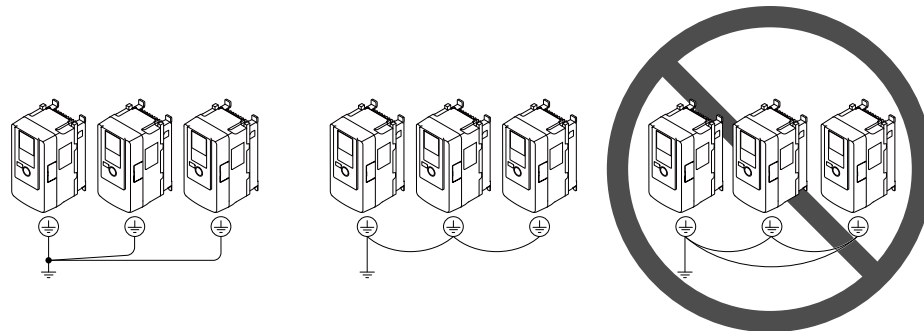

Figure 3.16 Wiring More than One Drive

■ Wiring the Main Circuit Terminal Block

WARNING! Electrical Shock Hazard. Before you wire the main circuit terminals, make sure that MCCB and MC are OFF. If you touch electrical equipment when MCCB and MC are ON, it can cause serious injury or death.

■ Main Circuit Configuration

The figures in this section show the different schematics of the drive main circuit. The connections change when the drive capacity changes. The DC power supply for the main circuit also supplies power to the control circuit.

WARNING! Fire Hazard. Do not connect a braking resistor to terminals +1 or -. Use terminals B1 and B2 for the braking resistor connections. If you connect a braking resistor to the incorrect terminals, it can cause damage to the drive and braking circuit and serious injury or death.

NOTICE: Do not use the negative DC bus terminal “-” as a ground terminal. This terminal is at high DC voltage potential. Incorrect wiring connections can cause damage to the drive.

Model	Figure
2004 to 2082, 4002 to 4044	Figure 3.17
2110 to 2138, 4060 to 4168	Figure 3.18
2169 to 2415, 4208 to 4414	Figure 3.19
4477 - 4720	Figure 3.20

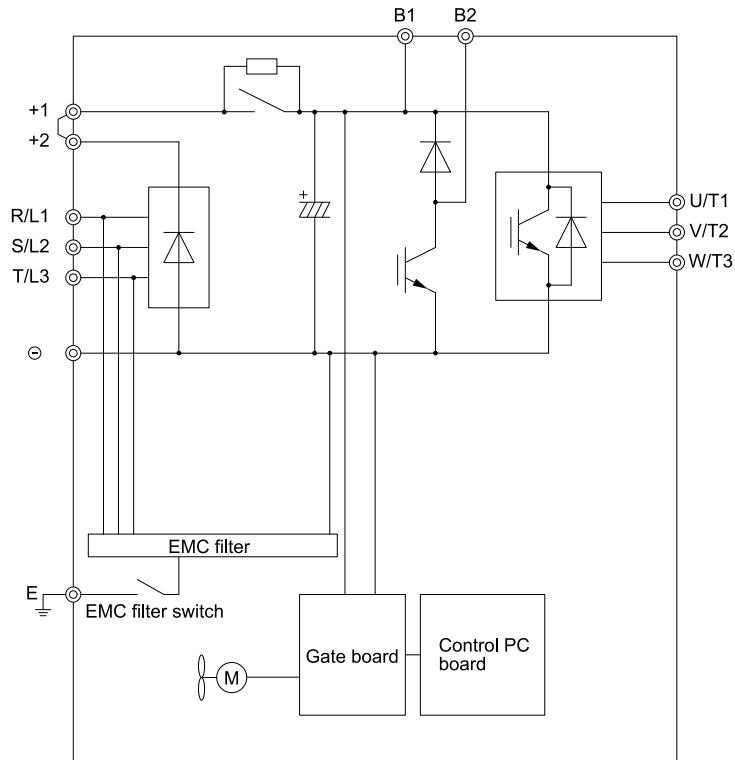

Figure 3.17 Drive Main Circuit Configuration

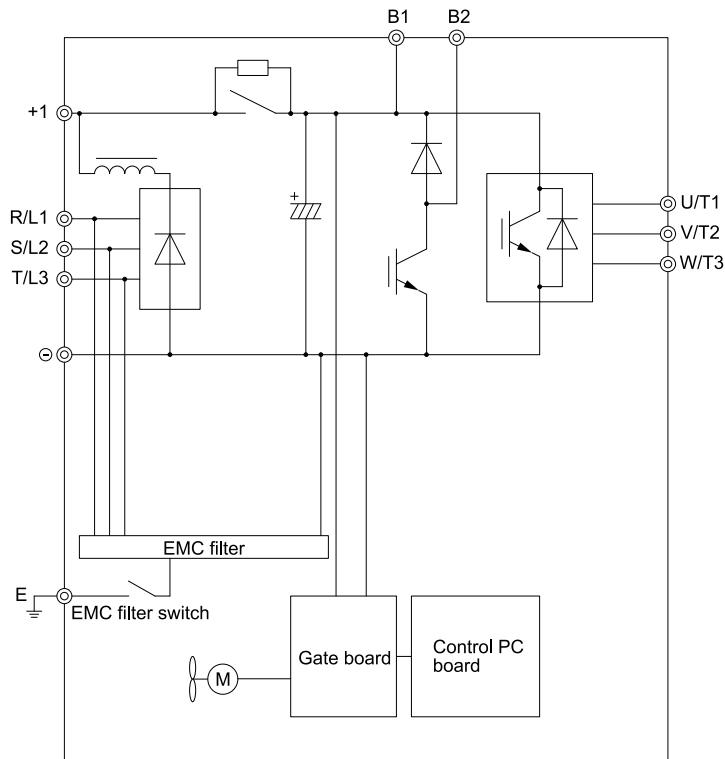

Figure 3.18 Drive Main Circuit Configuration

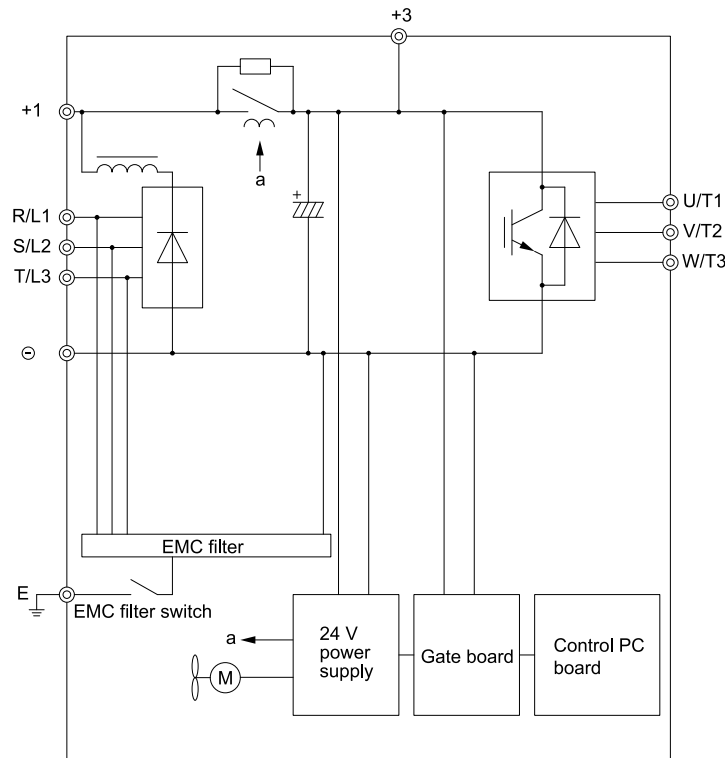

Figure 3.19 Drive Main Circuit Configuration

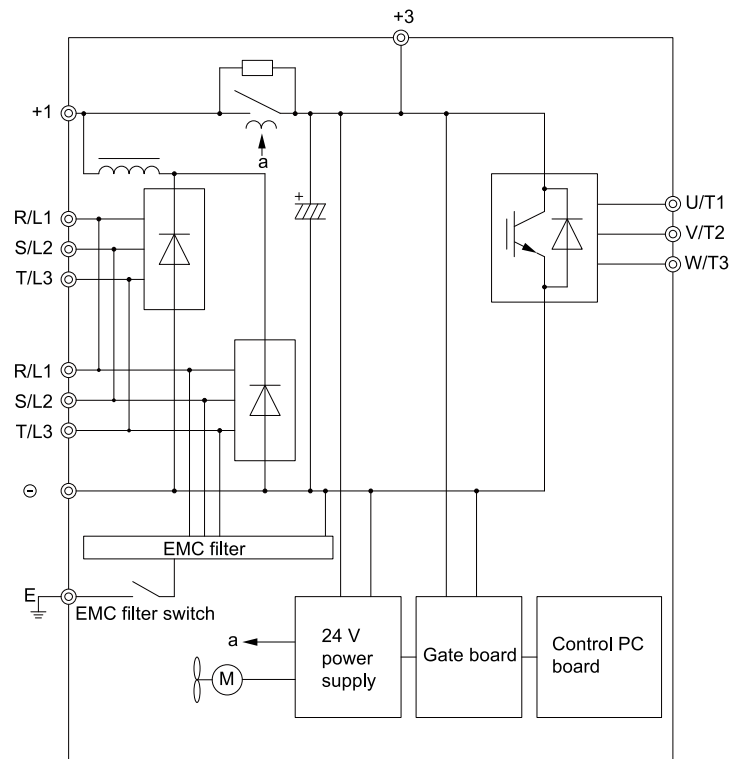

Figure 3.20 Drive Main Circuit Configuration

◆ Protection of Main Circuit Terminals

When you wire the main circuit terminals, do not let cable ends go near terminals or the drive. If you use crimped terminals, make sure that you also use insulation caps.

3.4 Main Circuit Terminal Block Wiring Procedure

DANGER! Electrical Shock Hazard. Do not examine, connect, or disconnect wiring on an energized drive. Before servicing, disconnect all power to the equipment and wait for the time specified on the warning label at a minimum. The internal capacitor stays charged after the drive is de-energized. The charge indicator LED extinguishes when the DC bus voltage decreases below 50 Vdc. When all indicators are OFF, remove the covers before measuring for dangerous voltages to make sure that the drive is safe. If you do work on the drive when it is energized, it will cause serious injury or death from electrical shock. The drive has internal capacitors that stay charged after you de-energize the drive.

The procedures to wire the main circuit terminal block are different for different drive models. Refer to [Table 3.4](#) for procedures by drive model.

Table 3.4 Types of Wiring Procedure for the Main Circuit Terminal Block

Model	Procedure	Reference
2004 - 2211 4002 - 4168	Procedure A	86
2257 - 2415 4208 - 4720	Procedure B	90

◆ Wire the Main Circuit Terminal Block with Procedure A

■ Notes on Wiring the Main Circuit Terminal Block

Read these notes before you wire the main circuit terminal block.

Note:

- Use UL-Listed, vinyl-coated insulated copper wires for operation with a continuous maximum permitted temperature of 75 °C at 600 V.
- Remove all unwanted objects that are near the terminal block connections.
- Remove the insulation from the connection wires to the wire stripping lengths shown in the manual.
- Do not use bent or crushed wires. Remove the damaged end of the wire before you use it. Incorrect connections can cause death or serious injury from fire.
- Do not solder stranded wire. Soldered wire connections can become loose over time and cause unsatisfactory drive performance.
- If you use stranded wire, make sure that all of the wire strands are in the connection. Also, do not twist the stranded wire too much. Incorrect connections can cause death or serious injury from fire.
- Put the wire all the way into the terminal block. Remove the insulation from the wire to the recommended wire stripping length to fit the wire with insulation in the plastic housing.
- Use a torque driver, torque ratchet, or torque wrench for the screws. A slotted driver or a hex tool will be necessary to wire the screw clamp terminal. Use applicable tools as specified by the recommended conditions in the product manual.
- If you use power tools to tighten the terminal screws, use a low speed setting (300 to 400 r/min). Failure to obey can cause damage to the terminal screws.
- Users can purchase wiring tools from Yaskawa. Contact Yaskawa or your nearest sales representative for more information.
- Wire gauges on existing drive models to be replaced may not match wire gauge ranges on new drives. Contact Yaskawa or your nearest sales representative for more information about the connection procedures.
- Do not tighten the terminal screws at an angle of 5 degrees or more. Failure to obey can cause damage to the terminal screws.

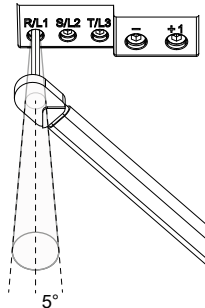

Figure 3.21 Permitted Angle

- Put the bit all the way into the hex socket to tighten the hex socket cap screw.
- When you tighten slotted screws, hold the straight-edge screwdriver perpendicularly to the screw. Make sure that you align the end of the straight-edge screwdriver with the screw groove.

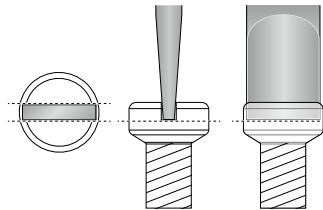
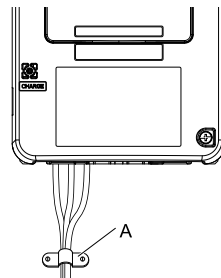

Figure 3.22 Tightening Slotted Screws

- After connecting the wires to the terminal block, lightly pull on the wires to make sure that they do not come out of the terminals.
- Remove the correct section of the wiring cover to make wiring easier.
- Do not let strain on the wiring cause damage. Use a strain relief near the wiring to release the tension. Refer to [Figure 3.23](#) for an example.



A - Cable clamp

Figure 3.23 Strain Relief Example

3.4 Main Circuit Terminal Block Wiring Procedure

Table 3.5 Recommended Wiring Tools

Screw Size	Screw Shape	Adapter	Bit		Torque Driver Model (Tightening Torque)	Torque Wrench
			Model	Manufacturer		
M4	Slotted (-)	Bit	SF-BIT-SL 1,0X4,0-70	PHOENIX CONTACT	TSD-M 3NM (1.2 - 3 N·m (10.6 - 26.6 in·lb))	-
M5 *1	Slotted (-)	Bit	F-BIT-SL 1,2X6,5-70	PHOENIX CONTACT	Wire Gauge ≤ 25 mm ² (AWG 10): TSD-M 3NM (1.2 - 3 N·m (10.6 - 26.6 in·lb))	Wire Gauge ≤ 25 mm ² (AWG 10): -
					Wire Gauge ≥ 30 mm ² (AWG 8): -	Wire Gauge ≥ 30 mm ² (AWG 8): 4.1 - 4.5 N·m (36.3 - 39.8 in·lb) *2 *3
M6	Hex socket cap (WAF: 5 mm)	Bit	SF-BIT-HEX 5-50	PHOENIX CONTACT	-	5 - 9 N·m (44.3 - 79.7 in·lb) *2 *3
	Slotted (-)	Bit	SF-BIT-SL 1,2X6,5-70	PHOENIX CONTACT	-	3 - 3.5 N·m (26.6 - 31.0 in·lb) *2 *3
M8	Hex socket cap (WAF: 6 mm)	Bit	SF-BIT-HEX 6-50	PHOENIX CONTACT	-	8 - 12 N·m (70.8 - 106.2 in·lb) *2 *3
M10	Hex socket cap (WAF: 8 mm)	Bit	SF-BIT-HEX 8-50	PHOENIX CONTACT	-	12 - 14 N·m (106.2 - 123.9 in·lb) *2 *3

*1 When wiring drive models 2056 and 4089 and smaller, select the correct tools for the wire gauge.

*2 Use 6.35 mm (0.25 in) bit socket holder.

*3 Use a torque wrench that can apply this torque measurement range.

■ Main Circuit Terminal Block Wiring Procedure

Remove the keypad and front cover before wiring the main circuit terminal block.

1. Pull the wiring cover away from the drive to remove it.

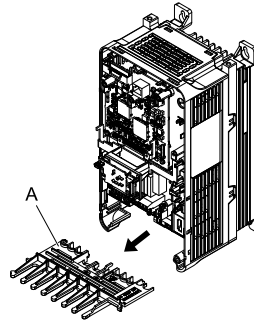

A - Wiring cover

Figure 3.24 Remove the Wiring Cover

2. Put the end of a prepared wire into the terminal block.

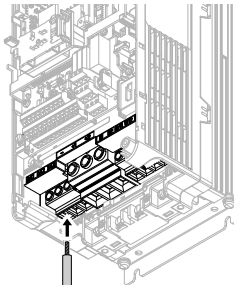

Figure 3.25 Install the Electrical Wire

Note:

If there is a jumper between terminals +1 and +2, loosen the terminal block screws and remove the jumper before wiring the terminals.

3. Tighten the screws to the specified torque.

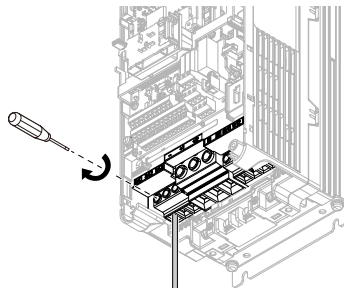
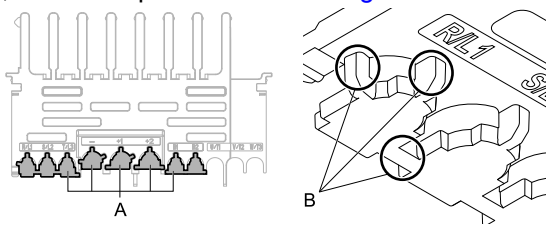

Figure 3.26 Tighten Terminal Block Screws

4. Examine the signal from the wired terminal and use a diagonal-cutting pliers to remove areas of the wiring cover cutaway section.

To remove the wiring cover, cut off the portion shown in [Figure 3.27](#).



A - Cutaway sections

B - Cut this portion with a diagonal-cutting pliers

Figure 3.27 Clip the Cutaway Section of the Wiring Cover

Note:

- Different drive models have different wiring cover shapes.
- Only clip the section of the wiring cover that applies to the wired terminal. If you clip areas that do not apply to wired terminals, the protective enclosure will not keep its IP20 protective level.
- Tightly hold the cutaway section when removing pieces of the cutaway section. Pieces of the cutaway section can fly out and cause injury.
- Make sure that the clipped section does not cause damage to the wires.
- If you use wires that are not specified by Yaskawa, the protective enclosure could lose its IP20 protective level, although the wiring cover is correct. Contact Yaskawa or your nearest sales representative for more information.

5. Put the wiring cover in its initial position. Put the cables through the holes cut from the wiring cover.

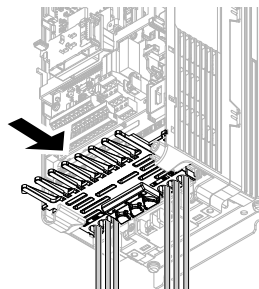

Figure 3.28 Reattach the Wiring Cover

6. Install the front cover and the keypad to their initial positions.

◆ Wire the Main Circuit Terminal Block with Procedure B

■ Notes on Wiring the Main Circuit Terminal Block

Note:

- After the wiring, do not twist or shake the electrical wires too much.
- Be sure to use only wires with the correct size, stripped wire length, and tightening torque as specified by Yaskawa.
- Use tools that fit the shape of the screw head to tighten and loosen the terminal block screws.
- Make sure that there are no loose stranded wires or frayed wires after wiring is complete.

■ Main Circuit Terminal Block Wiring Procedure

Remove the terminal cover before you wire the main circuit terminal block.

1. Remove the screws on the terminal block cover and pull the terminal block cover away from the drive. Pull the wiring cover away from the drive to remove the wiring cover after removing the terminal block cover.

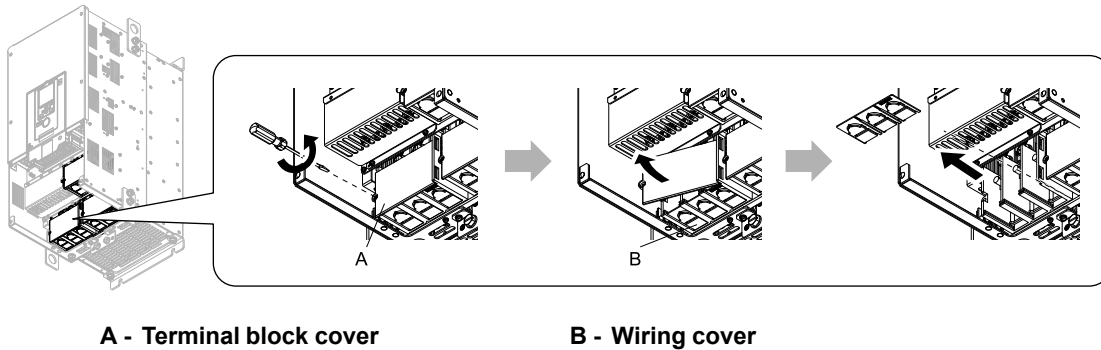

Figure 3.29 Remove the Wiring Cover

2. Remove the terminal block nut.

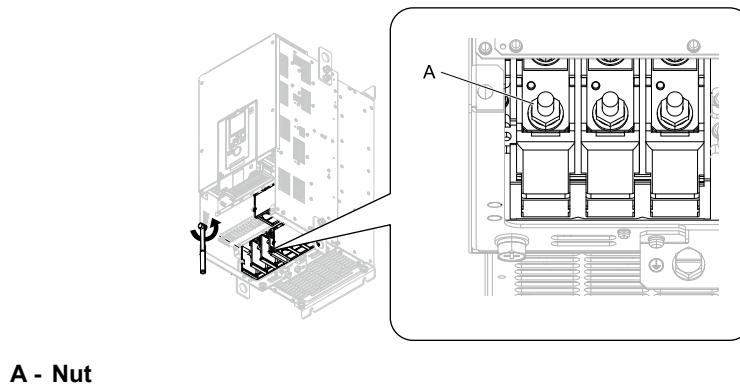

Figure 3.30 Remove the Terminal Block Nut

3. Wire the closed-loop crimp terminal to the main circuit terminal block.

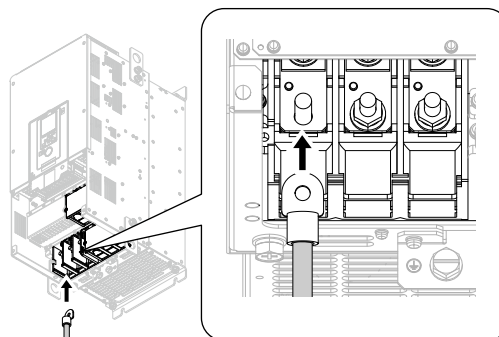

Figure 3.31 Install the Electrical Wire

4. Tighten the nut to the specified torque.

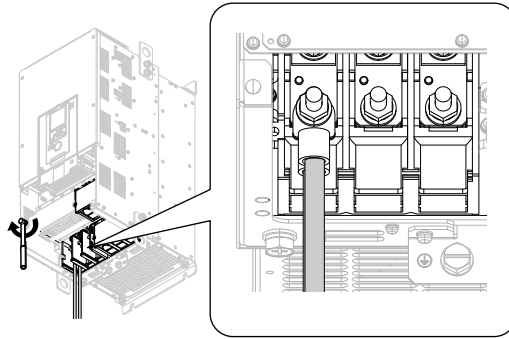
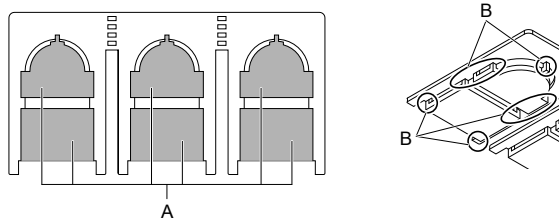

Figure 3.32 Tighten the Terminal Block Nut

5. Examine the signal from the wired terminal and use a diagonal-cutting pliers to remove areas of the wiring cover cutaway section. Cut the areas shown in [Figure 3.33](#).



A - Cutaway sections

B - Use a diagonal-cutting pliers to clip this area.

Figure 3.33 Clip the Cutaway Section of the Wiring Cover

Note:

- Different drive models have different wiring covers.
- Remove only the areas from the wiring cover that apply to the wired terminal. If you remove areas that do not apply to the wired terminals, the drive will not keep its IP20 protective level.
- Tightly hold the cutaway section when you remove pieces of the cutaway section. Pieces of the cutaway section can fly out and cause injury.
- Make sure that the clipped section does not cause damage to the wires.
- Although the wiring cover is correct, if you use wires that are not specified by Yaskawa, the drive will not keep its IP20 protective level.
- When you use the recommended gauge for the electrical wires, it is not necessary to attach the wiring cover of the main circuit power input terminal and the drive output terminal. When you use the applicable gauge for the electrical wires, attach the wiring cover.

6. Attach the wiring cover and terminal block cover to their initial positions and tighten the screws on the terminal block cover.

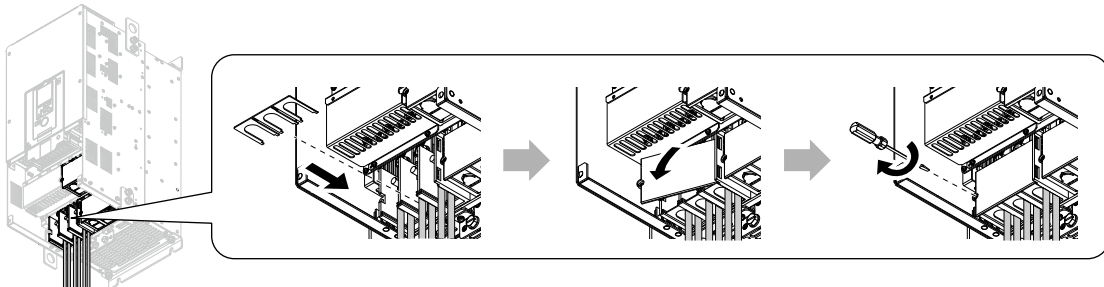

Figure 3.34 Reattach the Wiring Cover

7. Put the terminal cover back in its initial position.

3.5 Control Circuit Wiring

This section gives information about how to correctly wire the control circuit.

◆ Control Circuit Connection Diagram

Wire the drive control circuit as shown in Figure 3.35.

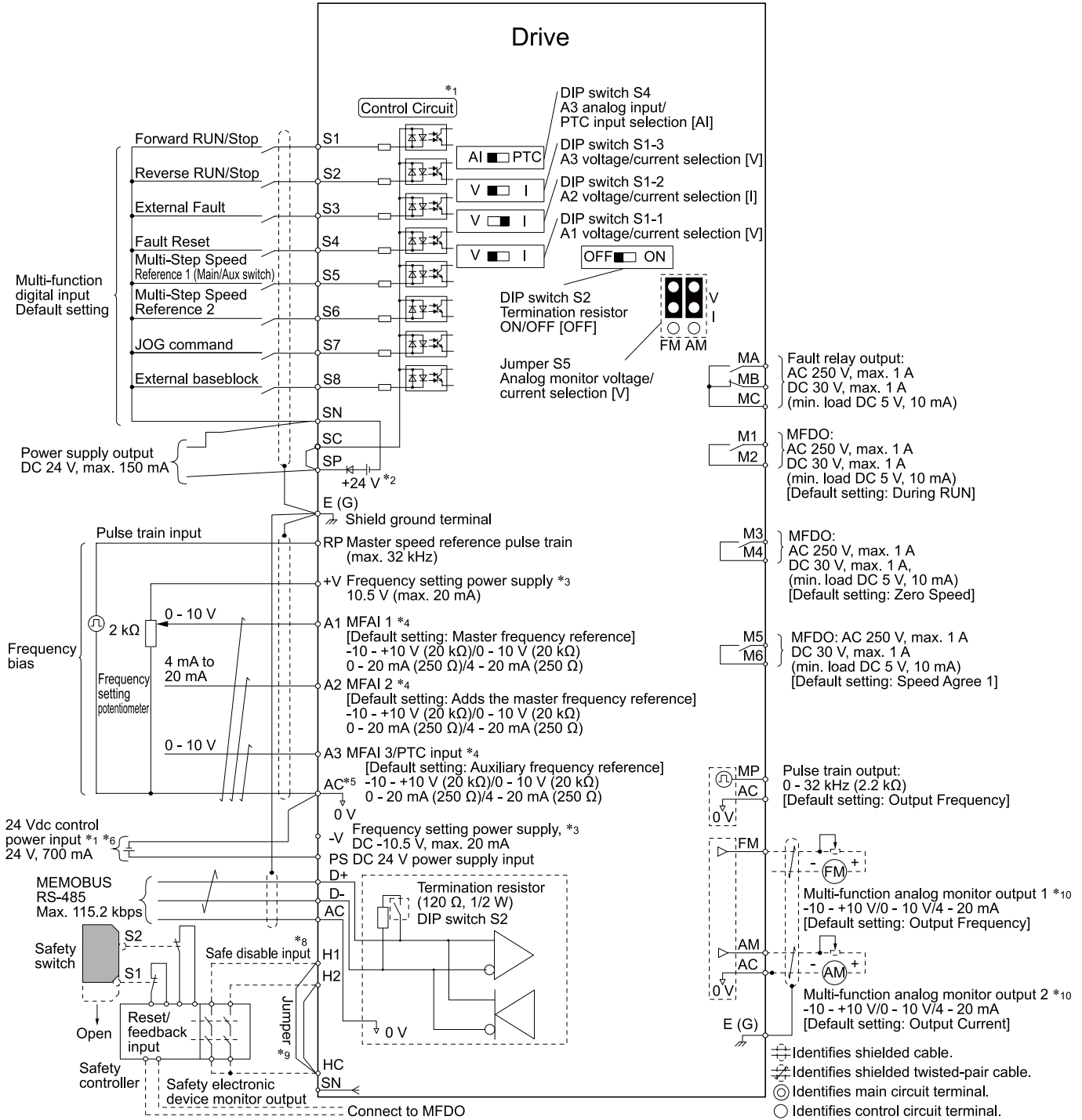

Figure 3.35 Control Circuit Connection Diagram

*1 Connect a 24 V Control power input supply to terminals PS-AC to operate the control circuit while the main circuit power supply is OFF.

- *2 To set the MFDI power supply (Sinking/Sourcing Mode or internal/external power supply), install or remove a jumper between terminals SC-SP or SC-SN depending on the application.
- NOTICE:** Do not close the circuit between terminals SP-SN. A closed circuit between these terminals will cause damage to the drive.
- Sinking Mode, Internal power supply: Install the jumper to close the circuit between terminals SC-SP.
NOTICE: Damage to Equipment. Do not close the circuit between terminals SC-SN. If you close the circuits terminals SC-SP and terminals SC-SN, it will cause damage to the drive.
 - Sourcing Mode, Internal power supply: Install the jumper to close the circuit between terminals SC-SN.
NOTICE: Damage to Equipment. Do not close the circuit between terminals SC-SP. If you close the circuits terminals SC-SP and terminals SC-SN, it will cause damage to the drive.
 - External power supply: Remove the jumper from the MFDI terminals. It is not necessary to close the circuit between terminals SC-SP and terminals SC-SN.
- *3 The output current capacity of the +V and -V terminals on the control circuit is 20 mA.
- NOTICE:** Do not install a jumper between terminals +V, -V, and AC. A closed circuit between these terminals will cause damage to the drive.
- *4 Set DIP switches S1-1 to S1-3 to select between a voltage or current input signal to terminals A1 to A3. The default setting for S1-1 and S1-3 is voltage input (“V” side). The default setting for S1-2 is current input (“I” side).
- *5 Do not ground the control circuit terminals AC or connect them to the drive chassis.
- NOTICE:** Do not ground the AC control circuit terminals and only connect the AC terminals according to the product instructions. If you connect the AC terminals incorrectly, it can cause damage to the drive.
- *6 Do not connect terminals PS and AC inversely. Failure to obey will cause damage to the drive.
- *7 Set DIP switch S2 to the ON position to enable the termination resistor in the last drive when you use MEMOBUS/Modbus communications.
- *8 To use the internal power supply with the Safe Disable input, use sourcing mode.
- *9 Disconnect the wire jumpers between H1 and HC and H2 and HC to use the Safe Disable input.
- *10 Use multi-function analog monitor outputs with analog frequency meters, ammeters, voltmeters, and wattmeters. Do not use monitor outputs with feedback-type signal devices.

◆ Control Circuit Terminal Block Functions

Hx-xx parameters set functions for the multi-function input and output terminals.

WARNING! Sudden Movement Hazard. Correctly wire and test all control circuits to make sure that the control circuits operate correctly. If you use a drive that has incorrect control circuit wiring or operation, it can cause death or serious injury.

WARNING! Sudden Movement Hazard. Check the I/O signals and the external sequences for the drive before you set the Application Preset function. When you set the Application Preset function (A1-06 ≠ 0), it changes the I/O terminal functions for the drive and it can cause equipment to operate unusually. This can cause serious injury or death.

NOTICE: Damage to Equipment. The drive can fail if users frequently turn the drive ON and OFF with the MC on the power source side to Run and Stop the drive. Incorrect operation can decrease the service life of the relay contacts and electrolytic capacitors. If you frequently use the magnetic contactor on the power source side to Run and Stop the drive, it can cause drive failure.

■ Input Terminals

Refer to [Table 3.6](#) for a list of input terminals and functions.

Table 3.6 Multi-function Input Terminals

Type	Terminal	Name (Default)	Function (Signal Level)	
Digital Inputs	S1	MFDI selection 1 (ON: Forward run OFF: Stop)	<ul style="list-style-type: none"> Photocoupler 24 V, 6 mA <p>Note: Install the wire jumpers between terminals SC-SP and SC-SN to set the MFDI power supply (sinking/sourcing mode or internal/external power supply). • Sinking Mode: Install a jumper between terminals SC and SP.</p> <p>NOTICE: Damage to Equipment. Do not close the circuit between terminals SC-SN. If you close the circuits terminals SC-SP and terminals SC-SN, it will cause damage to the drive.</p> <ul style="list-style-type: none"> Sourcing Mode: Install a jumper between terminals SC and SN. <p>NOTICE: Damage to Equipment. Do not close the circuit between terminals SC-SP. If you close the circuits terminals SC-SP and terminals SC-SN, it will cause damage to the drive.</p> <ul style="list-style-type: none"> External power supply: No jumper necessary between terminals SC-SN and terminals SC-SP. 	
	S2	MFDI selection 2 (ON: Reverse run OFF: Stop)		
	S3	MFDI selection 3 (External fault (N.O.))		
	S4	MFDI selection 4 (Fault reset)		
	S5	MFDI selection 5 (Multi-step speed reference 1)		
	S6	MFDI selection 6 (Multi-step speed reference 2)		
	S7	MFDI selection 7 (Jog command)		
	S8	MFDI selection 8 (Baseblock command (N.O.))		
	SN	MFDI power supply 0 V		MFDI power supply, 24 V (maximum 150 mA)
	SC	MFDI selection common		NOTICE: Do not close the circuit between terminals SP-SN. A closed circuit between these terminals will cause damage to the drive.
SP	MFDI power supply +24 Vdc			
Safe Disable Input	H1	Safe Disable input 1	Remove the jumper between terminals H1-HC and H2-HC to use the Safe Disable input.	
	H2	Safe Disable input 2	<ul style="list-style-type: none"> 24 V, 6 mA ON: Normal operation OFF: Coasting motor Internal impedance 4.7 kΩ OFF Minimum OFF time of 2 ms. 	
	HC	Safe Disable function common	Safe Disable function common NOTICE: Do not close the circuit between terminals HC and SN. A closed circuit between these terminals will cause damage to the drive.	
Master Frequency Reference	RP	Master frequency reference pulse train input (Master frequency reference)	<ul style="list-style-type: none"> Response frequency: 0 Hz to 32 kHz H level duty: 30% to 70% H level voltage: 3.5 V to 13.2 V L level voltage: 0.0 V to 0.8 V Input impedance: 3 kΩ 	
	+V	Power supply for frequency setting	10.5 V (allowable current 20 mA maximum)	
	-V	Power supply for frequency setting	-10.5 V (allowable current 20 mA maximum)	
	A1	MFAI1 (Master frequency reference)	Voltage input or current input Select terminal A1 with DIP switch S1-1 and H3-01 [Terminal A1 Signal Level Select]. Select terminal A2 with DIP switch S1-2 and H3-09 [Terminal A2 Signal Level Select]	
	A2	MFAI2 (Combined to terminal A1)		
	A3	MFAI3/PTC input (Auxiliary frequency reference)	<ul style="list-style-type: none"> Voltage input or current input Select using DIP switch S1-3 and H3-05 [Terminal A3 Signal Level Select]. <ul style="list-style-type: none"> -10 V to +10 V/-100% to +100% (input impedance: 20 kΩ) 0 V to 10 V/100% (input impedance: 20 kΩ) 4 mA to 20 mA/100%, 0 mA to 20 mA/100% (input impedance: 250 Ω) PTC input (Motor Overheat Protection) Set DIP switch S4 to "PTC" and set DIP switch S1-3 to "V" to set terminal A3 for PTC input. 	
	AC	Frequency reference common	0 V	
	E (G)	Connecting shielded cable	-	

■ **Output Terminals**

Refer to [Table 3.7](#) and [Table 3.8](#) for a list of output terminals and functions.

Table 3.7 Control Circuit Output Terminals

Type	Terminal	Name (Default)	Function (Signal Level)
Fault Relay Output	MA	N.O. output (Fault)	<ul style="list-style-type: none"> Relay output 30 Vdc, 10 mA to 1 A 250 Vac, 10 mA to 1 A Minimum load: 5 V, 10 mA (Reference value)
	MB	N.C. output (Fault)	
	MC	Digital output common	
MFDO	M1	MFDO (During Run)	<ul style="list-style-type: none"> Relay output 30 Vdc, 10 mA to 1 A 250 Vac, 10 mA to 1 A Minimum load: 5 V, 10 mA (Reference value) <p>Note: Do not set functions that frequently switch ON/OFF to MFDO (M1 to M6) because this will decrease the performance life of the relay contacts. Yaskawa estimates switching life at 200,000 times (assumes 1 A, resistive load).</p>
	M2		
	M3	MFDO (Zero Speed)	
	M4		
	M5	MFDO (Speed Agree 1)	
	M6		

Table 3.8 Control Circuit Monitor Output Terminals

Type	Terminal	Name (Default)	Function (Signal Level)
Monitor Output	MP	Pulse train output (Output frequency)	32 kHz (maximum) Refer to "Pulse Train Output" on page 102 for more information.
	FM	Analog monitor output 1 (Output frequency)	Select voltage or current output. <ul style="list-style-type: none"> 0 V to 10 V/0% to 100% -10 V to +10 V/-100% to +100% 4 mA to 20 mA (receiver recommended impedance: 250 Ω)
	AM	Analog monitor output 2 (Output current)	<p>Note: Select with jumper switch S5 and H4-07 [Terminal FM Signal Level Select] or H4-08 [Terminal AM Signal Level Select].</p>
	AC	Monitor common	0 V

External Power Supply Input Terminals

Refer to Table 3.9 for a list of the functions of the external power supply input terminals.

Table 3.9 External Power Supply Input Terminals

Type	Terminal	Name (Default)	Function
External Power Supply Input Terminals	PS	External 24 V power supply input	Supplies backup power to the drive control circuit, keypad, and option board. 21.6 VDC to 26.4 VDC, 700 mA
	AC	External 24 V power supply ground	0 V

Alarm Display When You Use External 24 V Power Supply

When you use an external 24 V power supply, the drive detects an alarm as shown in Table 3.10 if you set o2-23 [External 24V Powerloss Detection] and o2-26 [Alarm Display at Ext. 24V Power] for the main circuit power supply. Set the alarm display as necessary.

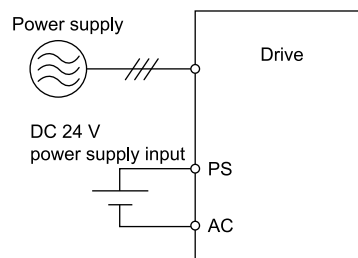

Table 3.10 Power Supply and Alarm Display

Main Circuit Power Supply	External 24 V Power Supply	o2-23 [External 24V Powerloss Detection]	o2-26 [Alarm Display at Ext. 24V Power]	Alarm Display
ON	ON	-	-	-
ON	OFF	0 [Disabled]	-	-
		1 [Enabled]	-	L24v [Loss of External Power 24 Supply]
OFF	ON	-	0 [Disabled]	"Ready" LED light flashes quickly
		-	1 [Enabled]	EP24v [External Power 24V Supply]

■ **Serial Communication Terminals**

Refer to [Table 3.11](#) for a list of serial communication terminals and functions.

Table 3.11 Serial Communication Terminals

Type	Terminal	Terminal Name	Function (Signal Level)	
Modbus Communication	D+	Communication input/output (+)	MEMOBUS/Modbus communications Use an RS-485 cable to connect the drive. Note: Set DIP switch S2 to ON to enable the termination resistor in the last drive in a MEMOBUS/Modbus network.	<ul style="list-style-type: none"> • RS-485 • MEMOBUS/Modbus communication protocol • Maximum 115.2 kbps
	D-	Communication output (-)		
	AC	Signal ground	0 V	

◆ **Control Circuit Terminal Configuration**

The control circuit terminals are in the positions shown in [Figure 3.36](#).

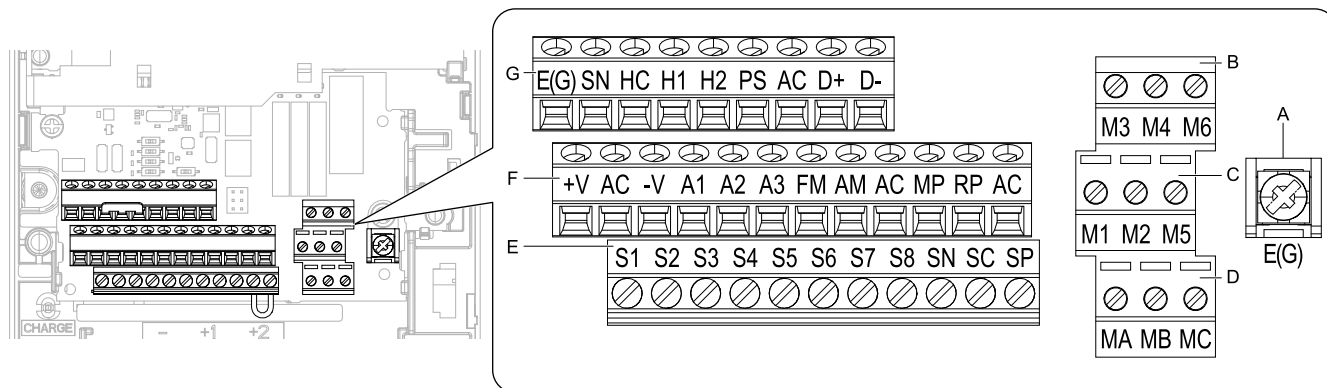

- A - Terminal block (TB5)
- B - Terminal block (TB2-3)
- C - Terminal block (TB2-2)
- D - Terminal block (TB2-1)
- E - Terminal block (TB1)
- F - Terminal block (TB3)
- G - Terminal block (TB4)

Figure 3.36 Control Circuit Terminal Arrangement

The tightening torque for the terminal screws is shown on the reverse side or the lower front side of the front cover.

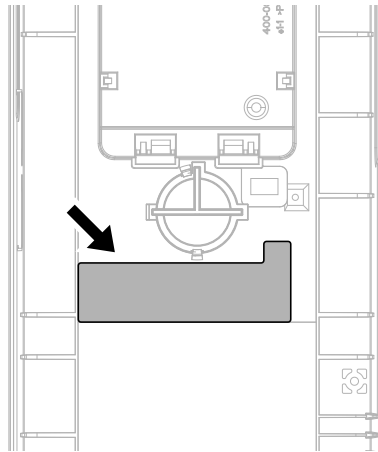

Figure 3.37 Tightening Torque Display Location (Reverse side of Front Cover)

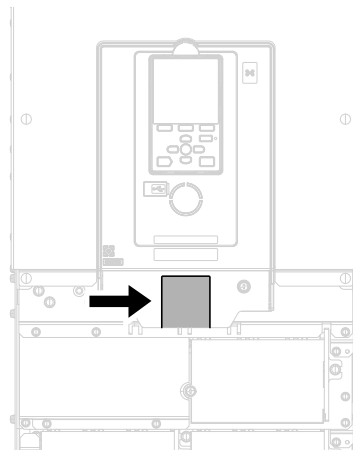

Figure 3.38 Tightening Torque Display Location (Lower Front Side of Front Cover)

■ Control Circuit Wire Gauges and Tightening Torques

Use the tables in this section to select the correct wires. Use shielded wire to wire the control circuit terminal block. Use crimp ferrules on the wire ends to make the wiring procedure easier and more reliable.

Table 3.12 Control Circuit Wire Gauges and Tightening Torques

Terminal Block	Terminal	Screw Size	Tightening Torque N·m (in·lb)	Bare Wire		Crimp Ferrule	
				Recommended Gauge mm ² (AWG)	Applicable Gauge mm ² (AWG)	Recommended Gauge mm ² (AWG)	Applicable Gauge mm ² (AWG)
TB1	S1 - S8, SN, SC, SP	M3	0.5 - 0.6 (4.4 - 5.3)	0.75 (18)	<ul style="list-style-type: none"> • Stranded wire 0.2 - 1.0 (24 - 16) • Solid wire 0.2 - 1.5 (24 - 16) 	0.5 (20)	0.25 - 0.5 (24 - 20)
TB2	M1 - M6, MA, MB, MC						
TB3	+V, AC, -V, A1, A2, A3, FM, AM, AC, MP, RP, AC						
TB4	E (G), SN, HC, H1, H2, PS, AC, D +, D-						
TB5	E (G)	M3.5	0.5 - 1.0 (4.4 - 8.9)	0.5 - 2 (20 - 14)	1.25 (12)	-	-

Crimp Ferrules

Attach an insulated sleeve when you use crimp ferrules. Refer to [Table 3.13](#) for the recommended external dimensions and model numbers of crimp ferrules.

Use the CRIMPFOX 6, a crimping tool made by PHOENIX CONTACT.

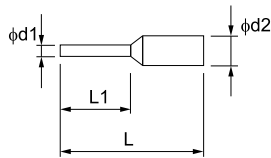

Figure 3.39 External Dimensions of Crimp Ferrules

Table 3.13 Crimp Ferrule Models and Sizes

Wire Gauge mm ² (AWG)	Model	L (mm)	L1 (mm)	φd1 (mm)	φd2 (mm)
0.25 (24)	AI 0.25-8YE	12.5	8	0.8	2.0
0.34 (22)	AI 0.34-8TQ	12.5	8	0.8	2.0
0.5 (20)	AI 0.5-8WH, AI 0.5-8OG	14	8	1.1	2.5

◆ Wiring the Control Circuit Terminal

WARNING! *Electrical Shock Hazard. Do not remove covers or touch circuit boards while the drive is energized. If you touch the internal components of an energized drive, it can cause serious injury or death.*

NOTICE: *Do not let wire shields touch other signal lines or equipment. Insulate the wire shields with electrical tape or shrink tubing. If you do not insulate the wire shields, it can cause a short circuit and damage the drive.*

Note:

- Isolate control circuit wiring from main circuit wiring (terminals R/L1, S/L2, T/L3, B1, B2, U/T1, V/T2, W/T3, -, +1, +2, +3) and other high-power wiring. If control circuit wiring is adjacent to main circuit wiring, it can cause incorrect operation of the drive and equipment from electrical interference.
- Isolate wiring for contact output terminals MA, MB, MC and M1-M6 from other control circuit wiring. If contact output terminal wiring is adjacent to other control circuit wiring, it can cause incorrect operation of the drive and equipment from electrical interference.
- Use a Class 2 power supply to connect external power to the control terminals. If the power supply for peripheral devices is incorrect, it can cause a decrease in drive performance.
- Connect the shield of shielded cable to the applicable ground terminal. Incorrect equipment grounding can cause drive or equipment malfunction from electrical interference.

Correctly ground the drive terminals and complete main circuit wiring before you wire the control circuit. Remove the keypad and front cover.

1. Push in on the tabs on the both sides of the LED status ring board to release the board from the bracket. Pull the board forward to remove it.

NOTICE: *When you remove the LED Status Board from the drive bracket, make sure that you temporarily install it in the holding position provided on the drive. If you cause damage to the LED status ring board, the LEDs will not function correctly.*

Note:

You can temporarily store the LED status ring board with the temporary placement holes on the drive. The location of the temporary placement holes is different on different drive models.

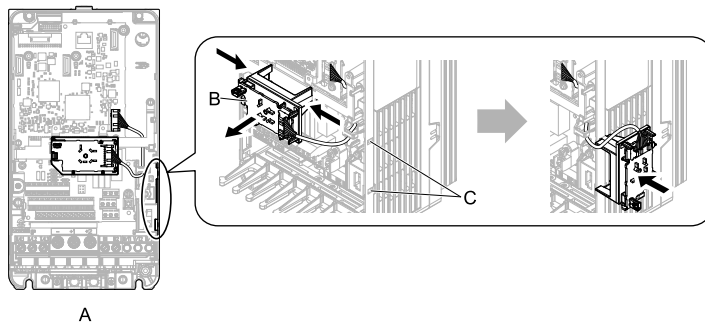

A - Drive front

B - LED status ring board

C - Temporary placement holes

Figure 3.40 Remove the LED Status Ring Board

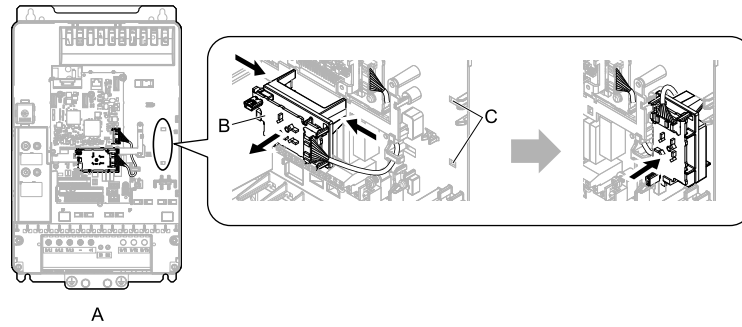

A - Drive front

B - LED status ring board

C - Temporary placement holes

Figure 3.41 Remove the LED Status Ring Board

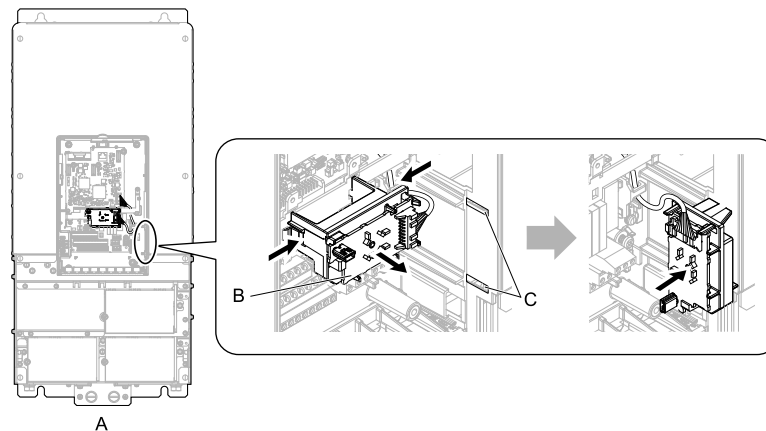

A - Drive front

B - LED status ring board

C - Temporary placement holes

Figure 3.42 Remove the LED Status Ring Board

2. Refer to the following figure and wire the control circuit.

WARNING! Fire Hazard. Tighten all terminal screws to the correct tightening torque. Connections that are too loose or too tight can cause incorrect operation and damage to the drive. Incorrect connections can also cause death or serious injury from fire.

Note:

- Use shielded, twisted-pair wires and ground the shield to the ground terminal of the drive. Incorrect equipment grounding can cause drive or equipment malfunction from electrical interference.
- Do not use control circuit wiring that is longer than 50 m (164 ft) to supply the analog frequency reference from a remote source. If the control circuit wiring is too long, it can cause unsatisfactory system performance.

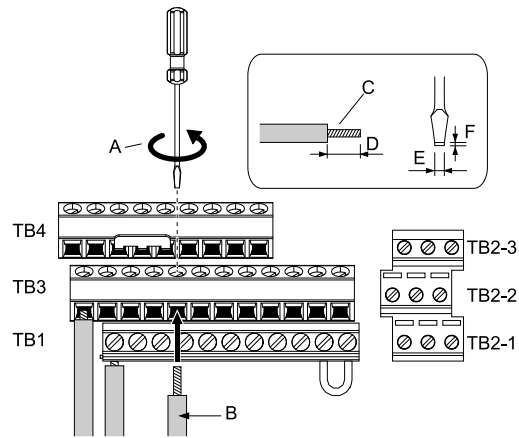

- A - Loosen the screws and put the wire into the opening on the terminal block.**
- B - Wire with a crimp ferrule attached, or unsoldered wire with the core wires lightly twisted**
- C - Pull back the shielding and lightly twist the end with your fingers to keep the ends from fraying.**
- D - Remove approximately 5.5 mm (0.21 in) of the covering at the end of the wire when you do not use crimp ferrules.**
- E - Blade width of 2.5 mm (0.1 in) or less**
- F - Blade thickness of 0.4 mm (0.01 in) or less**

Figure 3.43 Wiring Procedure for the Control Circuit

Note:

- Do not solder the core wire. Soldered wiring connections can become loose and cause the drive to malfunction.
- Tighten all terminal screws to the correct tightening torque. Connections that are too loose or too tight can cause incorrect operation and damage to the drive. Incorrect connections can also cause death or serious injury from fire.
- Refer to [Figure 3.44](#) for information to prepare terminal ends of the shielded wire.
- Prepare the wire ends of shielded twisted-pair wires as shown in [Figure 3.44](#) to use an analog reference from an external frequency setting potentiometer to set the frequency. Connect the shield to terminal E (G) of the drive.

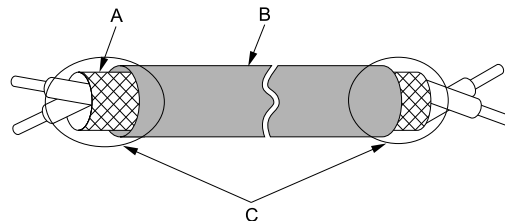

- A - Connect the shield to terminal E (G) of the drive.**
- B - Sheath**
- C - Insulate with electrical tape or shrink tubing.**

Figure 3.44 Prepare the Ends of Shielded Wire

3. Put the cable through the clearance in the wiring cover.

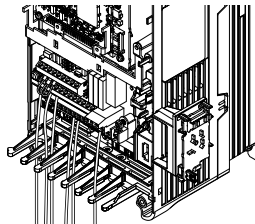

Figure 3.45 Control Circuit Wiring

4. Install the LED status ring board, front cover, and the keypad to their initial positions.

◆ Switches and Jumpers on the Terminal Board

The terminal board has switches to adapt the drive I/Os to the external control signals as shown in [Figure 3.46](#). Set the switches to select the functions for each terminal.

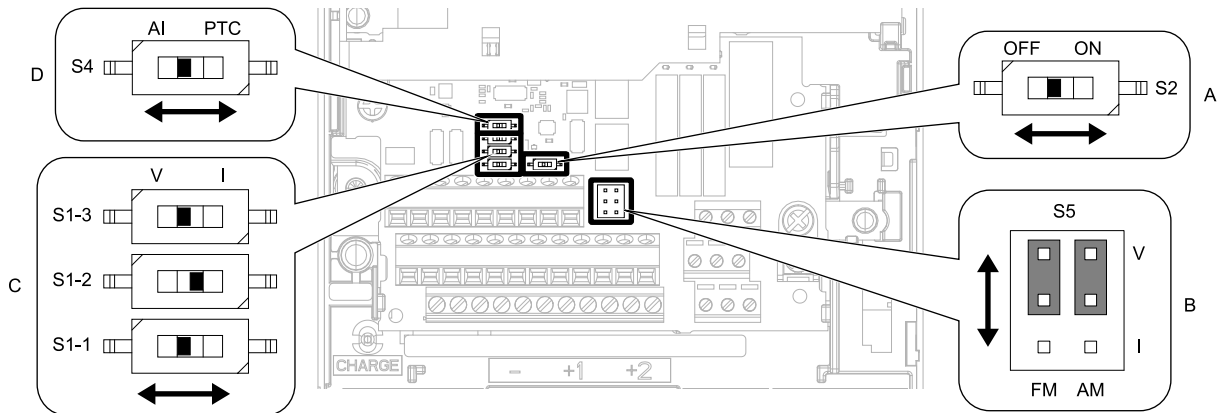

Figure 3.46 Locations of Switches

Table 3.14 I/O Terminals and Switches Functions

Position	Switch	Terminal	Function	Default
A	DIP switch S2	-	Enables and disables the MEMOBUS/Modbus communications termination resistor.	OFF
B	Jumper switch S5	FM, AM	Sets terminals FM and AM to voltage or current output.	FM: V (voltage output) AM: V (voltage output)
C	DIP switch S1-1	A1	Sets the input signal type (voltage/current).	V (voltage input)
	DIP Switch S1-2	A2	Sets the input signal type (voltage/current).	I (current input)
	DIP switch S1-3	A3	Sets the input signal type (voltage/current).	V (voltage input)
D	Dip switch S4	A3	Sets MFAI or PTC input.	AI (analog input)

3.6 Control I/O Connections

This section gives information about the settings for the listed control circuit I/O signals.

- MFDI (terminals S1 to S8)
- Pulse train output (terminal MP)
- MFAI (terminals A1 to A3)
- PTC input (terminal A3)
- MFAO (terminals FM, AM)
- MEMOBUS/Modbus communications (terminals D+, D-, AC)

◆ Set Sinking Mode/Sourcing Mode

Close the circuit between terminals SC-SP and SC-SN to set the sinking mode/sourcing mode and the internal/external power supply for the MFDI terminals. The default setting for the drive is internal power supply sinking mode.

NOTICE: Do not close the circuit between terminals SP-SN. A closed circuit between these terminals will cause damage to the drive.

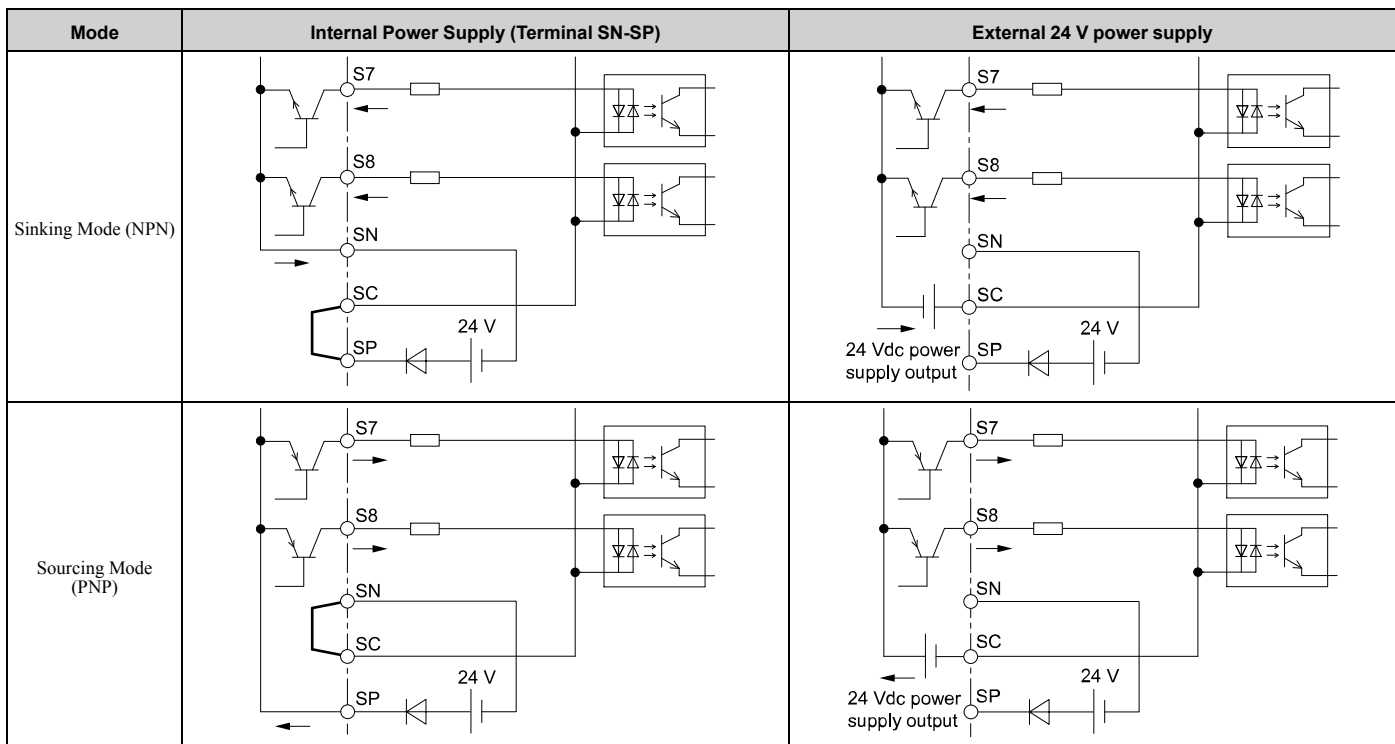

◆ Pulse Train Output

You can use pulse train monitor output terminal MP for sourcing mode or for sinking mode.

- Use for sourcing mode
The load impedance changes the voltage level of the pulse train output signal.

Load Impedance $R_L(k\Omega)$	Output Voltage $V_{MP}(V)$
1.5 k Ω or more	5 V or more
4.0 k Ω or more	8 V or more
10 k Ω or more	10 V or more

Note:

Use the formula in [Figure 3.47](#) to calculate the necessary load resistance (k Ω) to increase output voltage $V_{MP}(V)$.

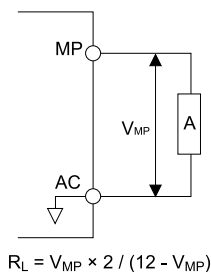

A - Load Impedance

Figure 3.47 Wiring to Use Pulse Train Output in Sourcing Mode

- Use in sinking mode

The external power supply changes the voltage level of the pulse train output signal. Keep the voltage from an external source between 10.8 Vdc to 16.5 Vdc. Adjust the load impedance to keep the current at 16 mA or lower.

External Power Supply (V)	Load Impedance (kΩ)	Sinking current (mA)
10.8 Vdc to 16.5 Vdc	1.0 kΩ or more	16 mA maximum

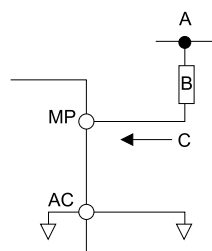

A - External power supply
B - Load Impedance

C - Sinking current

Figure 3.48 Wiring to Use Pulse Train Output in Sinking Mode

◆ **Set Input Signals for MFAI Terminals A1 to A3**

Use terminals A1 to A3 to input a voltage or a current signal. Set the signal type as shown in [Table 3.15](#).

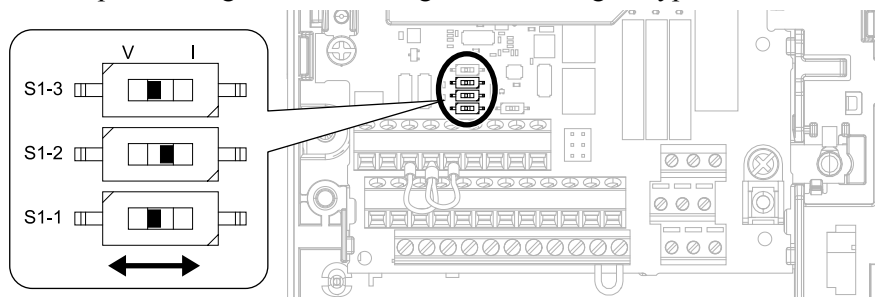

Figure 3.49 Location of DIP Switch S1

Table 3.15 MFAI Terminals A1 to A3 Signal Settings

Terminal	Input Signal	DIP Switch Settings		Parameter	
		Switch	Setting	No.	Signal Level
A1	Voltage input	S1-1	V (Default)	H3-01	0: 0 V to 10 V/0% to 100% (input impedance: 20 kΩ) 1: -10 V to +10 V/-100% to 100% (input impedance: 20 kΩ)
	Current input		I		2: 4 mA to 20 mA/0% to 100% (input impedance: 250 Ω) 3: 0 mA to 20 mA/0% to 100% (input impedance: 250 Ω)
A2	Voltage input	S1-2	V	H3-09	0: 0 V to 10 V/0% to 100% (input impedance: 20 kΩ) 1: -10 V to +10 V/-100% to 100% (input impedance: 20 kΩ)
	Current input		I (Default)		2: 4 mA to 20 mA/0% to 100% (input impedance: 250 Ω) 3: 0 mA to 20 mA/0% to 100% (input impedance: 250 Ω)

3.6 Control I/O Connections

Terminal	Input Signal	DIP Switch Settings		Parameter	
		Switch	Setting	No.	Signal Level
A3	Voltage input	S1-3	V (Default)	H3-05	0: 0 V to 10 V/0% to 100% (input impedance: 20 kΩ) 1: -10 V to +10 V/-100% to 100% (input impedance: 20 kΩ)
	Current input		I		2: 4 mA to 20 mA/0% to 100% (input impedance: 250 Ω) 3: 0 mA to 20 mA/0% to 100% (input impedance: 250 Ω)

Note:

- Set H3-02, H3-10 = 0 [Terminal A1 Function Selection, Terminal A2 Function Selection = Frequency Reference] to set A1 and A2 to frequency reference. The drive will add the analog input values together to make the frequency reference.
- Use tweezers or a jig with a tip width of approximately 0.8 mm (0.03 in) to set DIP switches.
- Set DIP switch S4 to “AI” to use terminal A3 as an analog input (voltage/current) terminal. The default setting for DIP switch S4 is “AI”.

◆ Set MFAI Terminal A3 to PTC Input

Set terminal A3 as an MFAI or as the PTC input for motor overload protection.
Use DIP switch S4 to set the input function.

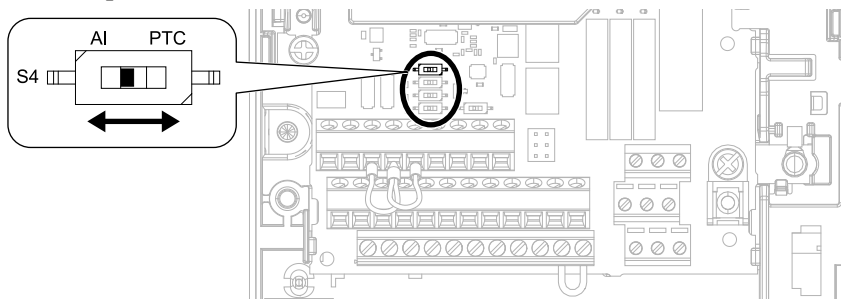

Figure 3.50 Location of DIP Switch S4

Terminal	Settings for DIP Switches	Description
A3	AI (Default)	Functions as an MFAI terminal. Set H3-06 [Terminal A3 Function Selection] to select the input function.
	PTC	Functions as the PTC input terminal. Set H3-06 = E [Motor Temperature (PTC Input)]. Set S1-3 to “V” for voltage input.

◆ Set Output Signals for MFAO Terminals FM, AM

Set the signal type for terminals AM and FM to voltage or current output. Use jumper switch S5 and H4-07, H4-08 [Terminal FM Signal Level Select, Terminal AM Signal Level Select] to set the signal type.

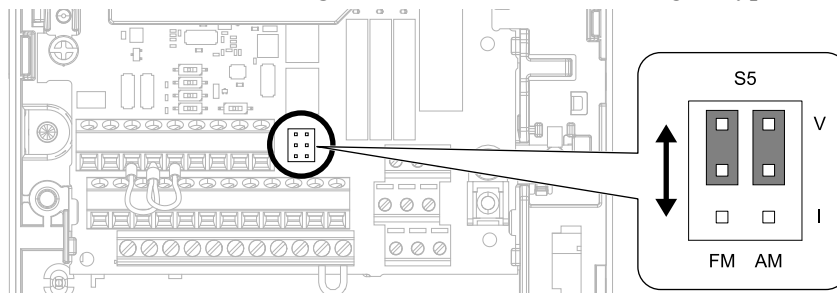
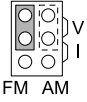
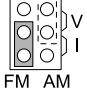
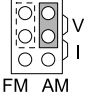



Figure 3.51 Location of Jumper Switch S5

Terminal	Types of Output Signals	Jumper Switch S5	Parameter	
			No.	Signal Level
FM	Voltage output (Default)		H4-07	0: 0 V to 10 V 1: -10 V to +10 V
	Current output			2: 4 mA to 20 mA
AM	Voltage output (Default)		H4-08	0: 0 V to 10 V 1: -10 V to +10 V
	Current output			2: 4 mA to 20 mA

◆ **Switch ON Termination Resistor for MEMOBUS/Modbus Communications**

When the drive is the last slave in a MEMOBUS/Modbus communications, set DIP switch S2 to the ON position. This drive has a built-in termination resistor for the RS-485 interface.

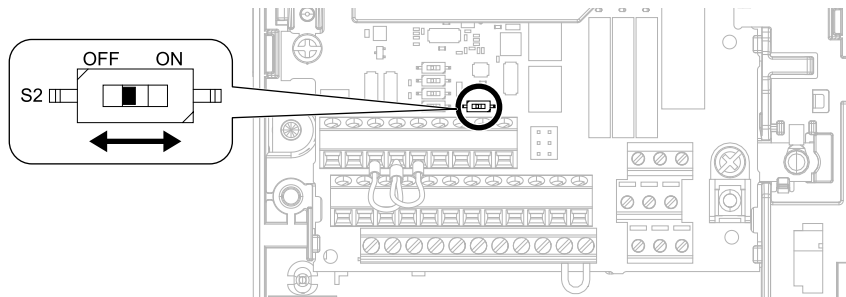

Figure 3.52 Location of DIP Switch S2

Table 3.16 MEMOBUS/Modbus Communications Termination Resistor Setting

DIP Switch S2	Description
ON	The built-in termination resistor is ON.
OFF (Default)	The built-in termination resistor is OFF.

3.7 Connect the Drive to a PC

The drive has a mini-B type USB port.

You can use a USB cable (USB 2.0, type: A - mini-B) to connect the drive to a type-A USB port on a PC. After you connect the drive to the PC, you can use Yaskawa DriveWizard Industrial software to monitor drive performance and manage parameter settings.

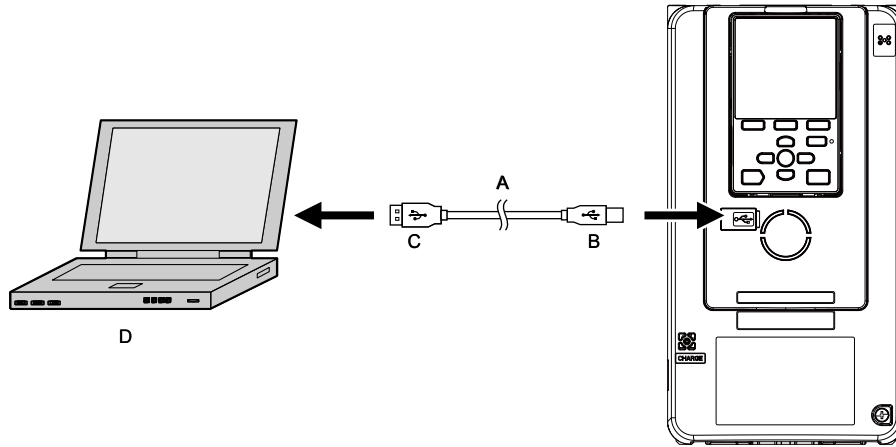

- A - USB 2.0, type A - mini-B cable
- B - Mini-B type connector
- C - Type-A connector
- D - PC

Figure 3.53 Connect to a PC (USB)

Yaskawa recommends that you use a USB cable with connectors connected with shielded wires.

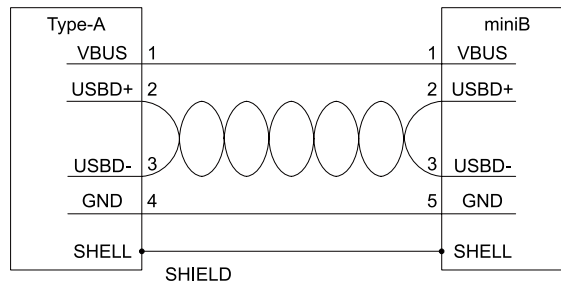

Figure 3.54 Recommended USB Cable

3.8 External Interlock

For applications that will have unwanted effects on the system if the drive stops, make an interlock between fault relay output (MA, MB, MC) and the MFDO *DriveReady* signal.

◆ Drive Ready

When the drive is operating or is prepared to accept a Run command, the MFDO terminal to which *Drive Ready* [H2-xx = 6] is set will enter the ON status.

In these conditions, Drive Ready is OFF and the drive ignores Run commands:

- The drive is de-energized
- During a fault
- There is problem with the control power supply
- There is a parameter setting error that will not let the drive run, although a Run command is entered
- An overvoltage or undervoltage fault occurs when the Run command is entered
- The drive is in Programming Mode.

◆ Interlock Circuit Example

Refer to [Figure 3.55](#) for an example of how two drives that run one application use the Drive Ready and Fault output signals to interlock with the controller.

Terminal	Output Signal	Parameter Settings for Output Signal
MA, MB, MC	Fault	-
M1-M2	Drive Ready	H2-01 = 6

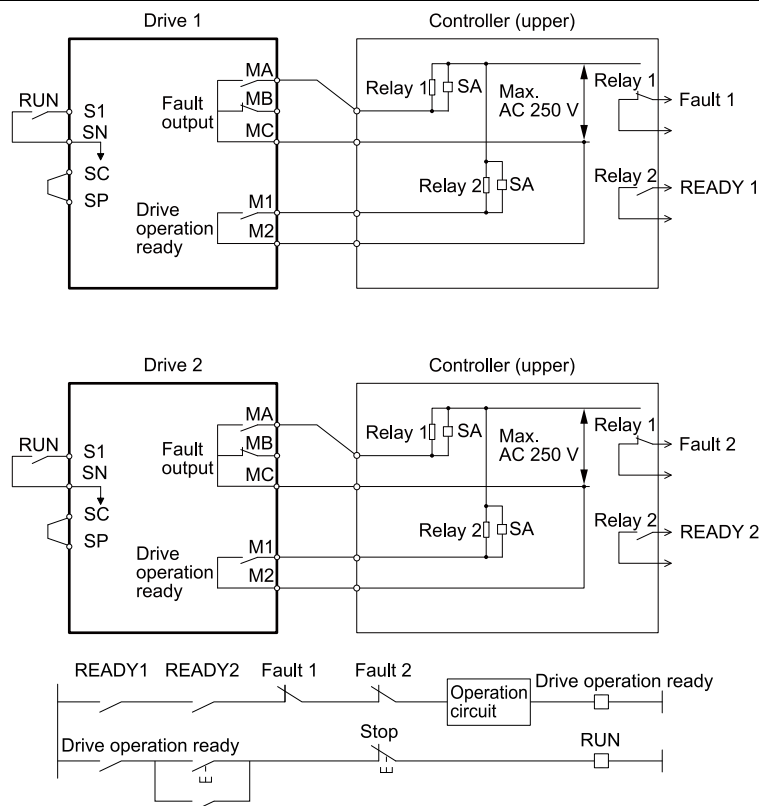

Figure 3.55 Interlock Circuit Example

3.9 Braking Resistor Installation

A braking resistor or braking resistor unit (dynamic braking option) helps stop the motor quickly and smoothly when there is high load inertia. If you try to decelerate a motor in less time than usual for a coast to stop, the motor will rotate faster than the synchronous speed that aligns with the set frequency. This will cause the motor to become an induction generator. The inertia energy of the motor and regenerate to the drive and charge the drive DC bus capacitor and increase the voltage. If the voltage is more than the overvoltage level, an *ov* [Overvoltage] will occur. To prevent these overvoltage faults, a dynamic braking option is necessary.

WARNING!

Set *L3-04* = 0 [Stall Prevention during Decel = Disabled] when you operate the drive with:

- a regenerative converter
- regenerative unit
- braking unit
- braking resistor
- braking resistor unit.

If you set the parameter incorrectly, the drive can decelerate for too long and cause serious injury or death.

NOTICE: Damage to Equipment. Before you connect a dynamic braking option to the drive, make sure that qualified personnel read and obey the Braking Unit and Braking Resistor Unit Installation Manual (TOBPC72060001). If you do not read and obey the manual or if personnel are not qualified, it can cause damage to the drive and braking circuit.

Note:

- Select the correct braking circuit size to dissipate the power that is necessary to decelerate the load in the correct time. Before you run the drive, make sure that the braking circuit can dissipate the energy for the set deceleration time.
- To install a dynamic braking option, set *L8-01* = 0 [3% ERF DB Resistor Protection = Disabled].

WARNING! Fire Hazard. Do not connect a braking resistor to terminals +1 or -. Use terminals B1 and B2 for the braking resistor connections. If you connect a braking resistor to the incorrect terminals, it can cause damage to the drive and braking circuit and serious injury or death.

NOTICE: Connect braking resistors to the drive as shown in the connection diagram examples. If you wire the braking circuits incorrectly, it can cause damage to the drive or equipment.

To connect a Yaskawa ERF series braking resistor to the drive, set *L8-01* = 1 [Enabled].

To use a non-ERF type braking resistor, connect a thermal overload relay between the drive and the braking resistor, and set a circuit to de-energize the drive at the trip contacts of the thermal overload relay.

◆ Install a Braking Resistor: ERF-Type

Connect the braking resistor to drive models 2004 to 2021 and 4002 to 4012 as shown in [Figure 3.56](#).

When you use a braking resistor, set *L8-01* = 1 [3% ERF DB Resistor Protection = Enabled] and set one of the MFDO parameters *H2-01* to *H2-03* = D [MFDO Function Select = Braking Resistor Fault]. Use a sequence that uses MFDO to de-energize the drive.

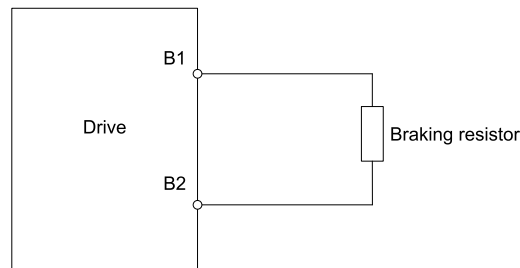

Figure 3.56 Install a Braking Resistor: ERF-Type

◆ Install a Braking Resistor Unit: LKEB-Type

Connect the braking resistor unit as shown in [Figure 3.57](#). To install a braking resistor unit, set *L8-01* = 0 [3% ERF DB Resistor Protection = Disabled].

Models 2004 to 2138 and 4002 to 4168 have a built-in braking transistor.

To prevent overheating the braking resistor unit, set a sequence to de-energize the drive at the trip contacts of the thermal overload relay.

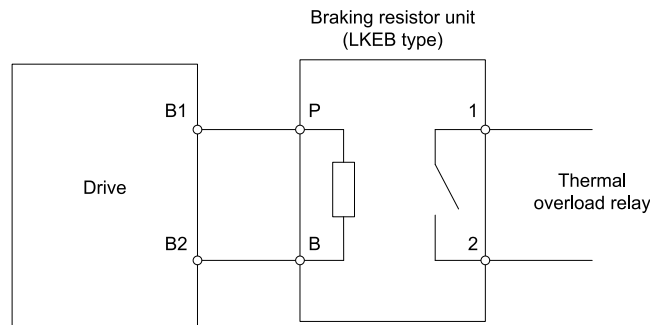

Figure 3.57 Install a Braking Resistor Unit: LKEB-Type

◆ Install a Braking Unit Connection: CDBR-Type

To install a CDBR type braking unit, connect terminal +3 on the drive to terminal + on the braking unit, and connect terminal - on the drive to terminal - on the braking unit. Terminal +2 on the drive is not necessary for CDBR-type braking unit connections.

Set $L8-55 = 0$ [Internal DB Transistor Protection = Disable].

Note:

- To install a CDBR-type braking unit to the drive models 2004 to 2138 and 4002 to 4168 that have a built-in braking transistor, connect drive terminal B1 to terminal + on the braking unit.
- A junction terminal is necessary to connect a braking unit (CDBR-series) to the drive models 2169, 2211, 4140, or 4168. Do wiring by installing a junction terminal that can connect to wires within the connectable range specified for the drive, peripheral devices, and options. The following table shows recommended junction terminals. Contact Yaskawa or your nearest sales representative for more information about selection and installation of the junction terminal.

Drive Model	Junction terminal model Manufacturer: Mibu Denki Industrial Co., Ltd.
2169, 4140, 4168	DTK-200N × 2P *1
2211	DTK-300N × 2P *1

*1 The junction terminal must have two or more poles.

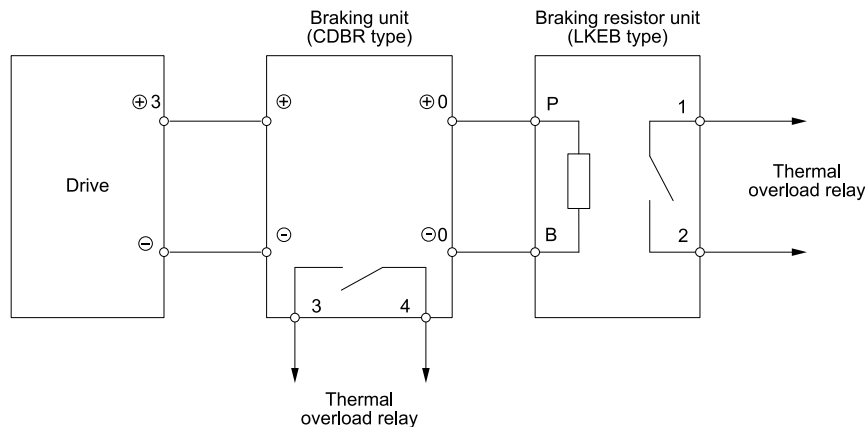

Figure 3.58 Install a Braking Unit: CDBR-Type/Braking Resistor Unit: LKEB-Type

■ Braking Unit Connection Wire Gauge (CDBR-Type)

To comply with IP20 when you connect the braking unit (CDBR-type) to the drive models 2257 to 2415 or 4208 to 4720, refer to [Table 3.17](#) and [Table 3.18](#) to select the wires.

3.9 Braking Resistor Installation

Table 3.17 200 V Class

Drive Model	Braking Unit (Quantity)	Drive Terminals	Recommended Gauge (AWG, kcmil)	Applicable Gauge (AWG, kcmil)	Reference
2257	CDBR-2022D (× 2) Specified Wire Gauge	+3	10 × 2P	10 - 8 × 2P	Figure 3.59
		-	10 × 2P	10 - 8 × 2P	Figure 3.59
	Applicable Gauge *1	+3	1/0 × 2P	4 - 1/0 × 2P	Figure 3.60
		-	1/0 × 2P *2	4 - 1/0 × 2P *2	Figure 3.60
2313	CDBR-2110D (× 1) Specified Wire Gauge	+3	3	3 - 2	Figure 3.59
		-	3	3 - 2	Figure 3.59
	Applicable Gauge *1	+3	1/0 × 2P	4 - 1/0 × 2P	Figure 3.60
		-	1/0 × 2P *2	4 - 1/0 × 2P *2	Figure 3.60
2360	CDBR-2110D (× 1) Specified Wire Gauge	+3	3	3 - 2	Figure 3.61
		-	3	3 - 2	Figure 3.61
2415	CDBR-2110D (× 1) Specified Wire Gauge	+3	3	3 - 2	Figure 3.61
		-	3	3 - 2	Figure 3.61

*1 This is the applicable wire gauge when you use a braking unit other than Yaskawa braking unit (CDBR-type).

*2 This is the applicable wire gauge when you use the same wires for terminal - and terminal +3.

Table 3.18 400 V Class

Drive Model	Braking Unit (Quantity)	Drive Terminals	Recommended Gauge (AWG, kcmil)	Applicable Gauge (AWG, kcmil)	Reference
4208	CDBR-4045D (× 2) Specified Wire Gauge	+3	10 × 2P	10 - 8 × 2P	Figure 3.59
		-	10 × 2P	10 - 8 × 2P	Figure 3.59
	Applicable Gauge *1	+3	1/0 × 2P	4 - 1/0 × 2P	Figure 3.60
		-	1/0 × 2P *2	4 - 1/0 × 2P *2	Figure 3.60
4250	CDBR-4220D (× 1) Specified Wire Gauge	+3	3	3 - 2	Figure 3.59
		-	3	3 - 2	Figure 3.59
	Applicable Gauge *1	+3	1/0 × 2P	4 - 1/0 × 2P	Figure 3.60
		-	1/0 × 2P *2	4 - 1/0 × 2P *2	Figure 3.60
4302	CDBR-4220D (× 1) Specified Wire Gauge	+3	3	3 - 2	Figure 3.59
		-	3	3 - 2	Figure 3.59
	Applicable Gauge *1	+3	1/0 × 2P	4 - 1/0 × 2P	Figure 3.60
		-	1/0 × 2P *2	4 - 1/0 × 2P *2	Figure 3.60
4371	CDBR-4220D (× 1) Specified Wire Gauge	+3	3	3 - 2	Figure 3.61
		-	3	3 - 2	Figure 3.61
4414	CDBR-4220D (× 1) Specified Wire Gauge	+3	3	3 - 2	Figure 3.61
		-	3	3 - 2	Figure 3.61
4477	CDBR-4220D (× 1) Specified Wire Gauge	+3	3	3 - 2	Figure 3.62
		-	3	3 - 2	Figure 3.62
	Applicable Gauge *1	+3	3/0 × 4P	2 - 4/0 × 4P	Figure 3.64
		-	3/0 × 4P *2	2 - 4/0 × 4P *2	Figure 3.64

Drive Model	Braking Unit (Quantity)	Drive Terminals	Recommended Gauge (AWG, kcmil)	Applicable Gauge (AWG, kcmil)	Reference
4605	CDBR-4220D (× 1) Specified Wire Gauge	+3	3	3 - 2	Figure 3.62
		-	3	3 - 2	Figure 3.62
	Applicable Gauge *1	+3	3/0 × 4P	2 - 4/0 × 4P	Figure 3.64
		-	3/0 × 4P *2	2 - 4/0 × 4P *2	Figure 3.64
4720	CDBR-4220D (× 2) Specified Wire Gauge	+3	3 × 2P	3 - 2 × 2P	Figure 3.63
		-	3 × 2P	3 - 2 × 2P	Figure 3.63
	Applicable Gauge *1	+3	4/0 × 4P	2 - 4/0 × 4P	Figure 3.64
		-	4/0 × 4P *2	2 - 4/0 × 4P *2	Figure 3.64

*1 This is the applicable wire gauge when you use a braking unit other than Yaskawa braking unit (CDBR-type).

*2 This is the applicable wire gauge when you use the same wires for terminal - and terminal +3.

■ Cutaway Section of the Wiring Cover

Examine the terminal symbols on the braking unit and use a nipper to clip the cutaway section of the corresponding wiring cover.

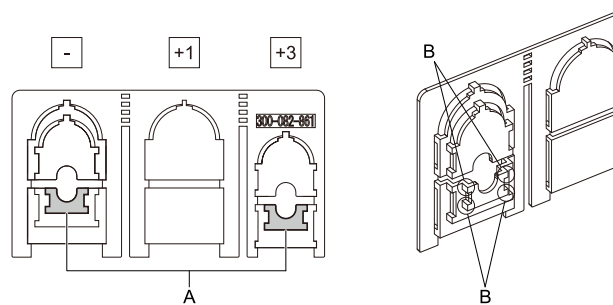

A - Cutaway sections

B - Use a diagonal-cutting pliers to clip this area.

Figure 3.59 Cutaway Sections

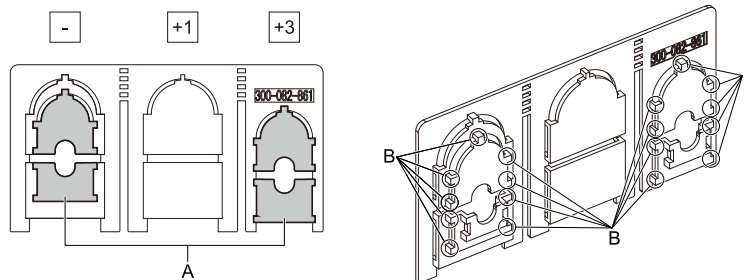

A - Cutaway sections

B - Use a diagonal-cutting pliers to clip this area.

Figure 3.60 Cutaway Sections

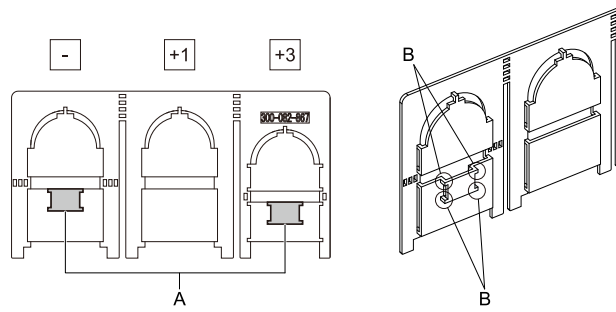

A - Cutaway sections

B - Use a diagonal-cutting pliers to clip this area.

Figure 3.61 Cutaway Sections

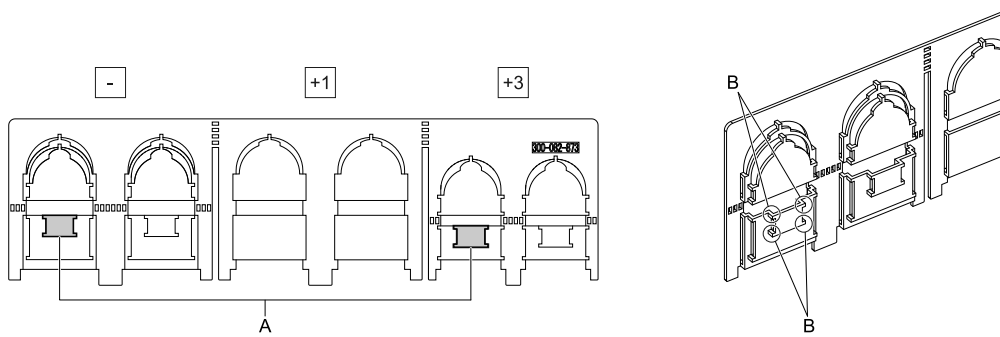

A - Cutaway section *1

B - Use a diagonal-cutting pliers to clip this area.

Figure 3.62 Cutaway Sections

*1 Cut away either of the two portions: terminal - or terminal +3. You may cut away either portion.

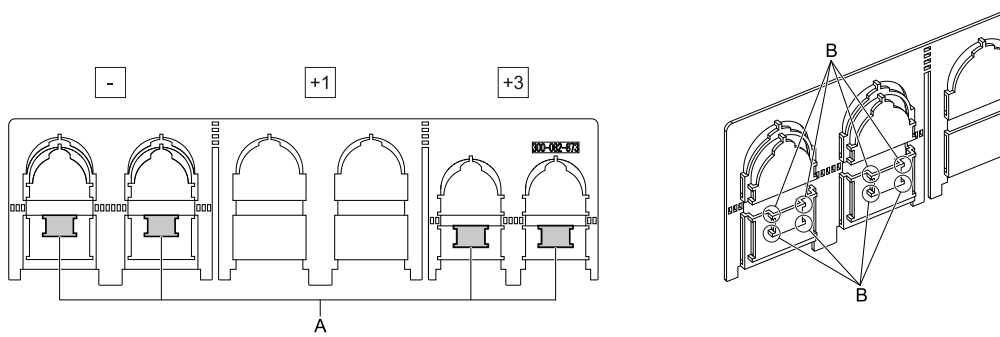

A - Cutaway sections

B - Use a diagonal-cutting pliers to clip this area.

Figure 3.63 Cutaway Sections

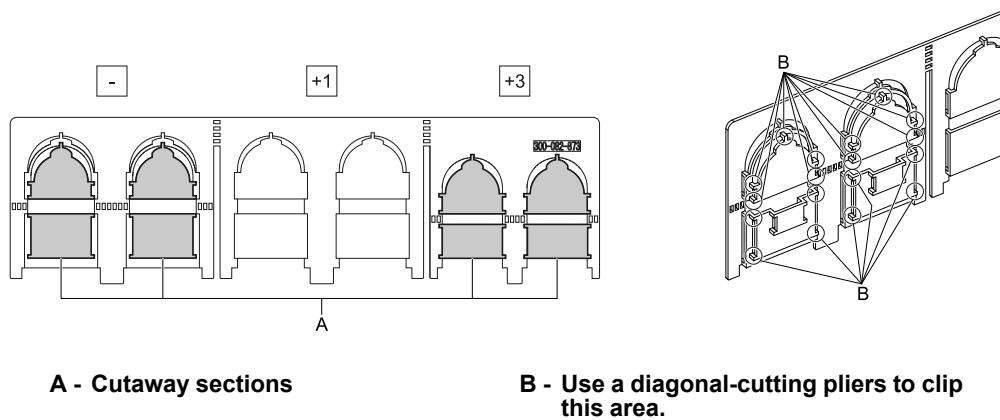

A - Cutaway sections

B - Use a diagonal-cutting pliers to clip this area.

Figure 3.64 Cutaway Sections

■ Installing a Braking Unit Connection (CDBR-Type)

Remove the terminal cover before connecting the braking unit (CDBR-type) to the drive.

1. Remove the screws on the terminal block cover and pull the terminal block cover away from the terminal block. Pull the wiring cover away from the drive to remove the wiring cover after removing the terminal block cover.

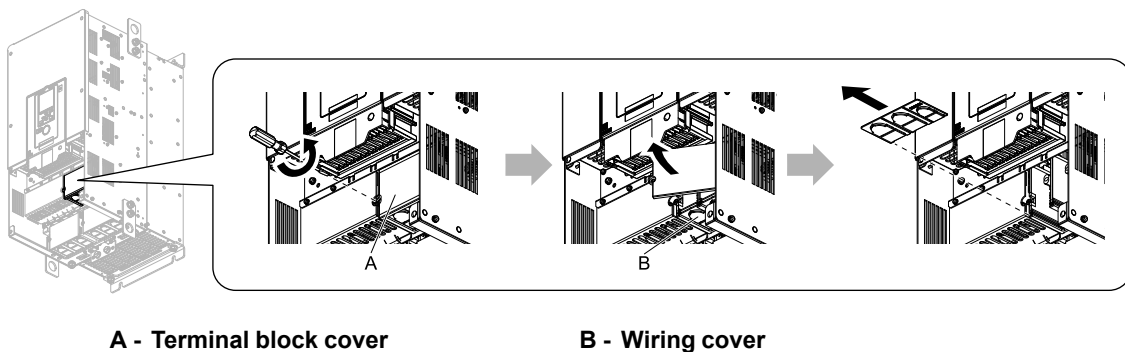

A - Terminal block cover

B - Wiring cover

Figure 3.65 Remove the Wiring Cover

2. Examine the signal from the wired terminal and use a diagonal-cutting pliers to remove areas of the wiring cover cutaway section.
For details, refer to [Cutaway Section of the Wiring Cover on page 111](#).

Note:

- Different drive models have different wiring covers.
- Remove only the areas from the wiring cover that apply to the wired terminal. If you remove areas that do not apply to the wired terminal, the drive will not keep its IP20 protective level.
- Make sure that you hold the cutaway section tightly when you remove pieces of the cutaway section. Pieces of the cutaway section can fly out and cause injury.
- Make sure that the clipped section does not cause damage to the wires.
- If you use the wiring cover correctly, but you use wires that are not specified by Yaskawa, the drive will not necessarily keep its IP20 protective level. Contact Yaskawa or your nearest sales representative for more information.
- When you use the recommended gauge for the electrical wires, it is not necessary to attach the wiring cover of the main circuit power input terminal and the drive output terminal. If you use the applicable gauge for the electrical wires, you must attach the wiring cover.

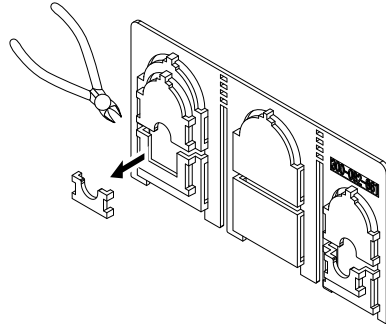
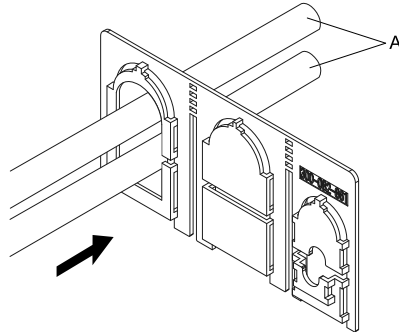

Figure 3.66 Clip the Cutaway Section of the Wiring Cover

- Put the wires through the holes that you cut out of the wiring cover.



A - Wire

Figure 3.67 Lead the Wire through the Wiring Cover

- Crimp the closed-loop crimp terminal to the wire.
- Remove the main circuit terminal block nut.

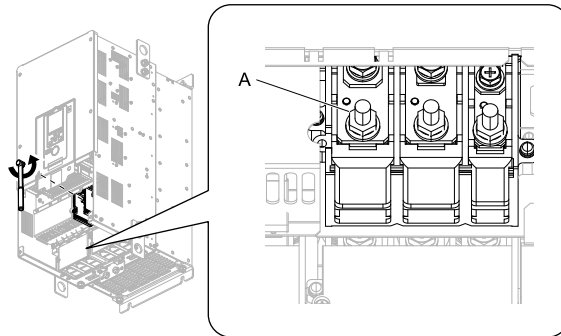

A - Nut

Figure 3.68 Remove the Terminal Block Nut

- Wire the closed-loop crimp terminal to the main circuit terminal block.

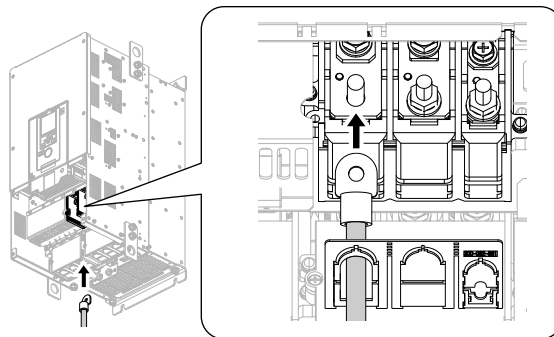

Figure 3.69 Connect the Wire

- Tighten the nut to the specified torque.

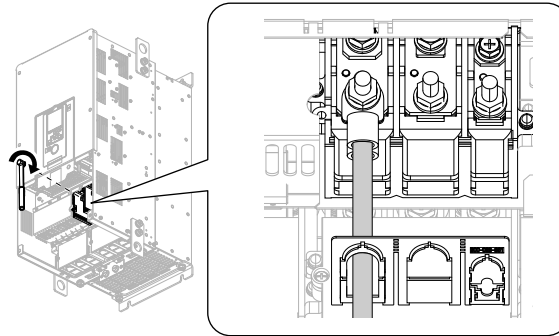

Figure 3.70 Tighten the Terminal Block Nut

- Attach the wiring cover and terminal block cover to their initial positions and tighten the screws on the terminal block cover.

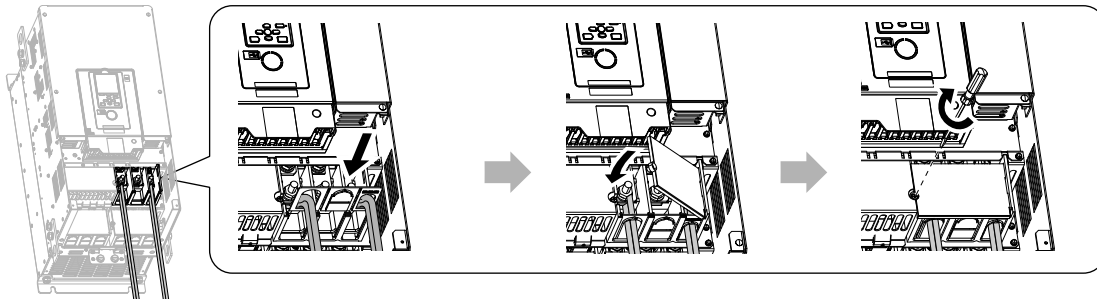

Figure 3.71 Reattach the Wiring Cover

- Put the terminal cover back in its initial position.

◆ Connect Braking Units in Parallel

To connect two or more braking units in parallel, refer to [Figure 3.72](#) for wiring and connector selections.

Braking units have connectors to select master or slave. On the first braking unit, select the master side. On the second unit and all subsequent units, select the slave side.

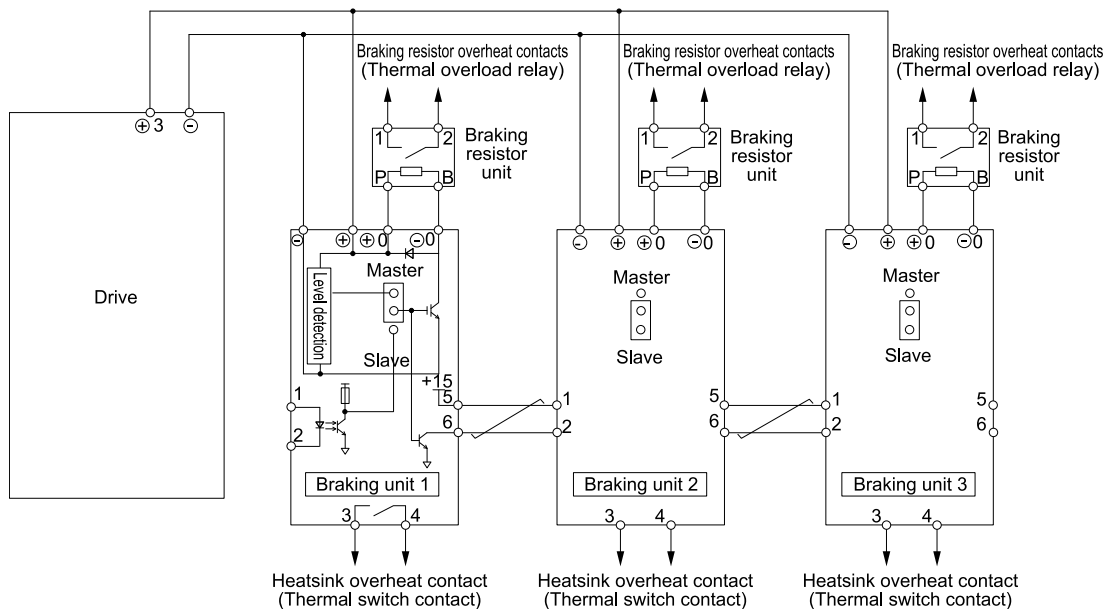

Figure 3.72 Connect Braking Units in Parallel

◆ **Dynamic Braking Option Overload Protection**

To prevent overheating the dynamic braking option, set a sequence to de-energize the drive at the trip contacts of the thermal overload relay.

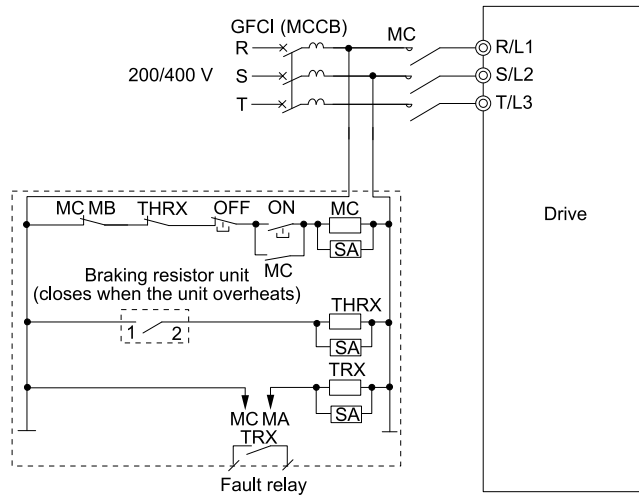

Figure 3.73 Power Supply Interrupt for Overheat Protection Example

WARNING! Fire Hazard. When you use a braking unit, use a thermal relay on the braking resistors and set a fault contact output for the braking resistor unit to disconnect drive main power through an input contactor. Incorrect braking circuit protection can cause the resistors to become too hot and cause serious injury or death.

3.10 Drive Wiring Protection

◆ Installing a Ground Fault Circuit Interrupter (GFCI)

When the drive output switches at high speeds, it causes high frequency leakage current. To prevent electrical shock and fires caused by ground fault protection that is not sufficient, install a GFCI.

Use a high frequency GFCI at the power input side of the drive and make sure that each drive has a minimum cumulative sensitivity amperage of 30 mA. The specialized breaker detects only the leakage current from frequency bands that are dangerous to humans.

If a device does not have protection against high frequencies, high frequency leakage currents can cause the device to malfunction. If you have a malfunction on a device that is not protected, decrease the carrier frequency of the drive, switch to a better breaker, or use a GFCI with a minimum cumulative sensitivity amperage of 200 mA for each drive.

These conditions can have an effect on leakage current:

- Drive capacity
- Carrier frequency
- Wiring distance and types of motor cables
- EMI/RFI filter

To prevent damage and injury to personnel and drives, use a high-frequency GFCI that is rated for AC and DC power supplies.

Note:

Yaskawa recommends these GFCIs, which are designed to operate with high frequencies:

- Mitsubishi Electric Corporation, NV series
- Schneider Electric, NS series

You can use a molded-case circuit breaker (MCCB) as a replacement for a GFCI that is upstream in the power supply system.

◆ Installing a Molded-Case Circuit Breaker (MCCB) or Ground Fault Circuit Interrupter (GFCI)

Install a molded-case circuit breaker (MCCB) or a ground fault circuit interrupter (GFCI) for line protection between the power supply and main circuit power supply input terminals R/L1, S/L2, and T/L3. The MCCB or GFCI gives overload protection and also prevent damage to the main circuit and the devices that are wired to the main circuit.

Use the information in this section to select the correct MCCB or GFCI and to safely connect the device.

- The capacity of the MCCB or GFCI must be 1.5 to 2 times the rated output current of the drive. Use an MCCB or GFCI as an alternative to overheat protection (150% for one minute at the rated output current) to prevent drive faults.
- When you connect more than one drive or the drive and other device to an MCCB or ELCB, refer to [Figure 3.74](#), use a magnetic contactor (MC), and set a sequence that de-energizes the drive when it outputs errors.

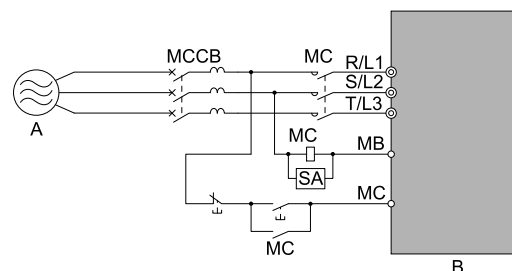

A - Power supply

B - Drive

Figure 3.74 Connect an MCCB

WARNING! Electrical Shock Hazard. Use an MCCB, GFCI, or Magnetic Contactor (MC) to de-energize the drive before you wire the main circuit terminal. If the main circuit terminal is energized during wiring, it will cause serious injury or death.

3.11 Dynamic Braking Option, Motor Protection

◆ Install an Electromagnetic Contactor (MC) at the Input Side of the Drive

You can use an MC as an alternative to a molded case circuit breaker (MCCB) when:

- The protective functions of the drive have been triggered
- An emergency stop occurred, and the sequence de-energizes the drive.

If an MC on the input side of the drive (primary side) stops the drive, regenerative braking will not operate, and the drive will coast to stop.

NOTICE: *When you connect electromagnetic switches or magnetic contactors to the output motor circuits, make sure that you sequence them correctly. If the output motor circuit sequence is incorrect, it can cause damage to the drive.*

NOTICE: *Damage to Equipment. The drive can fail if users frequently turn the drive ON and OFF with the MC on the power source side to Run and Stop the drive. Incorrect operation can decrease the service life of the relay contacts and electrolytic capacitors. If you frequently use the magnetic contactor on the power source side to Run and Stop the drive, it can cause drive failure.*

Note:

- When machinery must not restart after recovery from a momentary power loss that occurred during run, install an MC at the input side of the drive and set a sequence that does not automatically set the Run command to ON after recovery of power.
- When it is necessary to stop momentary power loss, for example to maintain a circuit that has momentary power loss, use a delayed-release MC.
- Use an MC (magnetic contactor) to make sure that you can fully remove power to the drive when necessary. Wire the MC to open when a fault output terminal is triggered.

■ Protect the Braking Resistor/Braking Resistor Unit

Use an MC on the input side (primary side) to prevent damage to the braking resistor/braking resistor unit.

WARNING! Fire Hazard. *When you use a braking unit, use a thermal relay on the braking resistors and set a fault contact output for the braking resistor unit to disconnect drive main power through an input contactor. Incorrect braking circuit protection can cause the resistors to become too hot and cause serious injury or death.*

◆ Installing a Thermal Overload Relay on the Drive Output

A thermal overload relay disconnects the power line to the motor during a motor overload condition to prevent damage to the motor.

Install a thermal overload relay between the drive and motor in these conditions:

- When you operate more than one motor with one drive
- When you operate the motor directly from the power line with a power line bypass

When you operate one motor with one drive, it is not necessary to install a thermal overload relay. The drive has electronic motor overload protection in the drive software.

Note:

- When you install a thermal overload relay, set parameter $L1-01 = 0$ [*Motor Overload (oL1) Protection = Disabled*].
- Set up a sequence that will trip an external fault (coast to stop) for the contacts of the thermal overload relay.

■ General Precautions When Using Thermal Overload Relays

When you use a motor thermal overload relay on the drive output to prevent nuisance trips and overheating of the motor at low speeds, be sure to think about these application precautions:

- Operation of a low speed motor
- When you operate more than one motor with one drive
- Length of the motor cables
- Nuisance tripping because of high drive carrier frequency

Operation of a Low Speed Motor

Usually, you use thermal overload relays on general-purpose motors (standard motors). When a drive drives a general-purpose motor, the motor current is approximately 5% to 10% more than with a commercial power supply. When a motor with a shaft-driven fan operates at low speeds, the cooling capacity decreases. This can cause the

motor to overheat when the load current is in the motor rated value. Enable the electronic thermal protection in the drive when possible to prevent this problem.

The electronic thermal overload function uses the relation between the speed and heat characteristics in the variable speed control range to simulate the cooling ability of general-purpose motors and forced-vented motors to prevent damage to the motor.

When You Operate More than One Motor with One Drive

To disable the overload protection function of the electronic thermal protector of the drive, set $LI-01 = 0$ [*Motor Overload (oL1) Protection = Disabled*].

Note:

If you operate more than one motor from one drive, you cannot use the electronic thermal protection of the drive.

Length of the Motor Cables

If you use long motor cables with a high carrier frequency, the increased leakage current can cause nuisance tripping of the thermal relay. To prevent this, decrease the carrier frequency or increase the tripping level of the thermal overload relay.

Nuisance Tripping Because of High Drive Carrier Frequency

High carrier frequency PWM drives make current waveforms that can increase the temperature in overload relays. It may be necessary to increase the trip level setting when encountering nuisance triggering of the relay.

WARNING! Fire Hazard. Before you increase the detection level of the thermal relay, make sure that a secondary problem is not the cause of the overload. Make sure that you know the local codes for electrical wiring, then adjust the electrothermal settings. Incorrect thermal relay adjustment and incorrect wiring can cause serious injury or death.

3.12 Improve the Power Factor

◆ Connect an AC Reactor or a DC Link Choke

AC reactors and DC link chokes decrease surges in current and improve the power factor on the input side of the drive.

Connect an AC reactor or a DC link choke the input side (primary side) in the these conditions:

- To decrease harmonic current or improve the power factor of the power supply
- When there is switching of phase advancing capacitor
- With a large capacity power supply transformer (600 kVA or more).

Note:

- You can use an AC reactor and DC link choke together.
- When you connect a thyristor converter (for example, a DC drive) to the same power supply system, you should use an AC reactor, regardless of the conditions of the power supply.
- The main circuit terminal block for the drive, and the terminal blocks for the AC reactor and DC Link Choke come in different shapes. The drive has a European-style terminal block, and the AC reactor and DC Link Choke have a circular terminal block. Correctly prepare the ends of the wiring.

■ Connect an AC Reactor

Note:

When you connect an AC reactor to the output side (secondary side) of the driver, set $C6-02 = 1$ [Carrier Frequency Selection = 2.0 kHz].

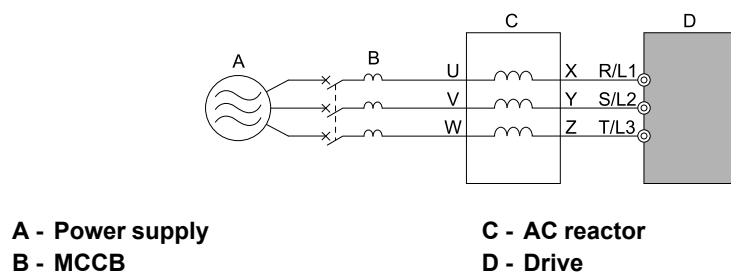

Figure 3.75 AC Reactor Connection Example

■ Connect a DC Link Choke

When you install a DC link choke, remove the jumper between terminals +1 and +2. If you will not use a DC link choke, do not remove the jumper. Refer to [Figure 3.76](#) for an example of how to wire the DC link choke.

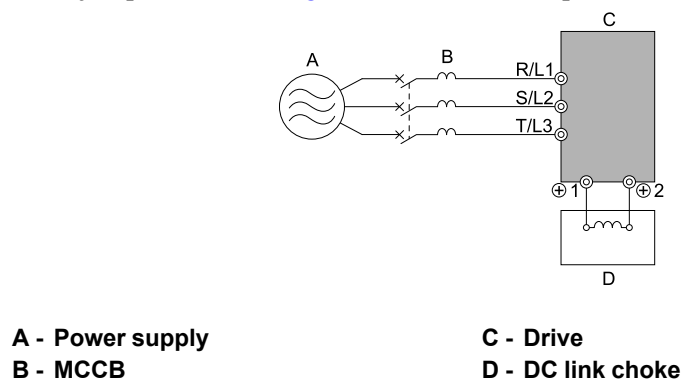

Figure 3.76 DC Link Choke Connection Example

3.13 Prevent Switching Surge

◆ Connect a Surge Protective Device

A surge protective device decreases the surge voltage generated when you switch an inductive load near the drive. Inductive loads include:

- Magnetic contactors
- Electromagnetic relays
- Magnetic valves
- Solenoids
- Magnetic brakes.

Always use a surge protective device or diode with inductive loads.

Note:

Do not connect a surge protective device to the drive output side.

■ Prevent Inductive Noise

In addition to installing a noise filter, you can also run all wiring through a grounded metal conduit to decrease inductive noise occurring at the output side. Put the cables a minimum of 30 cm (11.8 in) away from the signal line to prevent induced noise. Ground the cables to metal conduits.

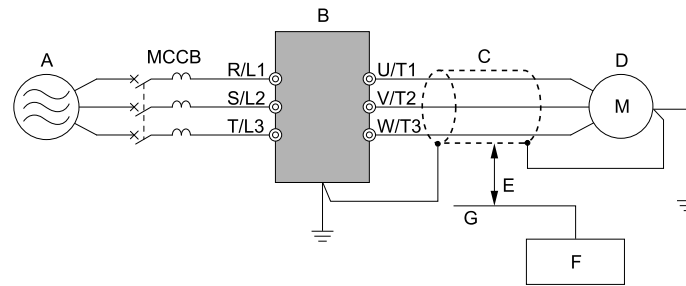

- | | |
|---------------------------------|---|
| A - Power supply | E - Minimum of 30 cm (11.8 in) apart |
| B - Drive | F - Controller |
| C - Shielded motor cable | G - Signal line |
| D - Motor | |

Figure 3.79 Prevent Inductive Noise

■ Decrease Radio Frequency Interference

The drive, input lines, and output lines generate radio frequency interference. Use noise filters on input and output sides and install the drive in a steel box to decrease radio frequency interference.

Note:

Keep the cable between the drive and motor as short as possible.

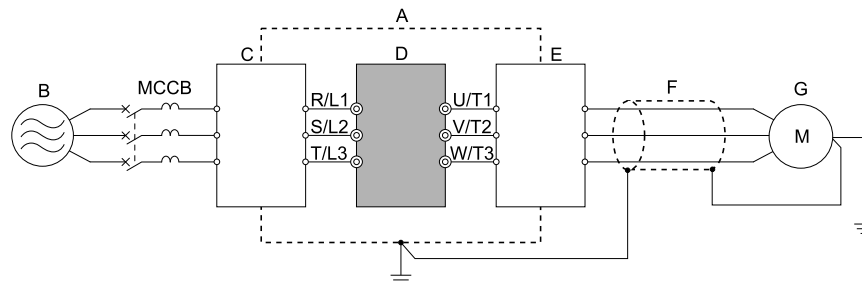

- | | |
|-------------------------|---------------------------------|
| A - Steel box | E - Noise filter |
| B - Power supply | F - Shielded motor cable |
| C - Noise filter | G - Motor |
| D - Drive | |

Figure 3.80 Decrease Radio Frequency Interference

3.15 Branch Circuit Protection

◆ Factory-Recommended Branch Circuit Protection for UL Listing

Yaskawa recommends installing one of the following types of branch circuit protection to maintain compliance with UL 508C. Semiconductor protective type fuses are preferred. Alternate branch circuit protection devices are also listed. Maximum Time Delay fuse is 175% of drive full load output amps (FLA). This covers any Class CC, J, or T class fuse. Refer to [200 V Class on page 124](#) and [400 V Class on page 125](#) for the recommended fuses.

WARNING! Electrical Shock Hazard. After the drive blows a fuse or trips a GFCI, do not immediately energize the drive or operate peripheral devices. Wait for the time specified on the warning label at a minimum and make sure that all indicators are OFF. Then check the wiring and peripheral device ratings to find the cause of the problem. If you do not know the cause of the problem, contact Yaskawa before you energize the drive or peripheral devices. If you do not fix the problem before you operate the drive or peripheral devices, it can cause serious injury or death.

- 200 V class

Use the fuses specified in this document to prepare the drive for use on a circuit that supplies not more than 100,000 RMS and not more than 240 Vac when there is a short circuit in the power supply.

- 400 V class

Use the fuses specified in this document to prepare the drive for use on a circuit that supplies not more than 100,000 RMS and not more than 480 Vac when there is a short circuit in the power supply.

The built-in short circuit protection of the drive does not provide branch circuit protection. The user must provide branch circuit protection as specified by the National Electric Code (NEC), the Canadian Electric Code, Part I (CEC), and local codes.

■ 200 V Class

Table 3.19 Factory Recommended Fuses for 200 V Class

Drive Model	Semiconductor Fuse Manufacturer: EATON/Bussmann	Alternate Time-Delay Class CC, J, or T */ Maximum Amp Rating (Maximum SCCR (kA))
2004	FWH-45B	6 (65)
2006	FWH-45B	10 (65)
2008	FWH-45B	12 (65)
2010	FWH-45B	15 (65)
2012	FWH-50B FWH-80B *2	20 (65)
2018	FWH-80B FWH-100B *2	30 (65)
2021	FWH-80B FWH-100B *2	35 (65)
2030	FWH-125B	50 (100)
2042	FWH-150B	70 (100)
2056	FWH-200B	90 (100)
2070	FWH-225A	110 (100)
2082	FWH-225A FWH-250A *2	125 (100)
2110	FWH-225A FWH-250A *2	175 (100)
2138	FWH-275A FWH-300A *2	225 (100)
2169	FWH-275A FWH-350A *2	250 (100)
2211	FWH-325A FWH-450A *2	350 (100)

Drive Model	Semiconductor Fuse Manufacturer: EATON/Bussmann	Alternate Time-Delay Class CC, J, or T ^{*1} Maximum Amp Rating (Maximum SCCR (kA))
2257	FWH-600A	400 (100)
2313	FWH-800A	500 (100)
2360	FWH-1000A	600 (100) ^{*3}
2415	FWH-1000A	800 (100) ^{*3}

*1 Class T fuses are fast-acting (non-time delay only).

*2 Yaskawa recommends a fuse with a larger rated current for cyclical load applications that frequently approach 150 % overload.

*3 For fuses rated 601 - 800 amps, you must use Class T fuses.

■ 400 V Class

Table 3.20 Factory Recommended Fuses for 400 V Class

Drive Model	Semiconductor Fuse Manufacturer: EATON/Bussmann	Alternate Time-Delay Class CC, J, or T ^{*1} Maximum Amp Rating (Maximum SCCR (kA))
4002	FWH-50B	3.5 (100)
4004	FWH-50B	7 (100)
4005	FWH-50B	9 (100)
4007	FWH-60B	12 (100)
4009	FWH-60B	15 (100)
4012	FWH-60B	20 (100)
4018	FWH-80B	30 (100)
4023	FWH-90B	40 (100)
4031	FWH-150B	50 (100)
4038	FWH-200B	60 (100)
4044	FWH-200B	70 (100)
4060	FWH-225A	100 (100)
4075	FWH-250A	125 (100)
4089	FWH-275A	150 (100)
4103	FWH-275A	175 (100)
4140	FWH-300A	225 (100)
4168	FWH-325A FWH-400A ^{*2}	250 (100)
4208	FWH-500A	350 (100)
4250	FWH-600A	400 (100)
4302	FWH-700A	500 (100)
4371	FWH-800A	Not applicable
4414	FWH-1000A	Not applicable
4477	FWH-1200A	Not applicable
4568	FWH-1200A	Not applicable
4605	FWH-1400A	Not applicable
4720	FWH-1400A	Not applicable

*1 Class T fuses are fast-acting (non-time delay only).

*2 Yaskawa recommends a fuse with a larger rated current for cyclical load applications that frequently approach 150 % overload.

3.16 External EMC Noise Filter Selection

Note:

Customer is responsible for EMC emissions with their final product in order to declare CE certification.

Table 3.21 External EMC Noise Filter (2xxxA)

Model	EMC Noise Filter Model	Quantity	Manufacturer
2004A	B84743A0008R176	1	TDK
2006A	B84743A0008R176	1	TDK
2008A	B84743A0017R176	1	TDK
2010A	B84743A0017R176	1	TDK
2012A	B84743A0017R176	1	TDK
2018A	B84743A0033R176	1	TDK
2021A	B84743A0033R176	1	TDK
2030A	B84743A0044R176	1	TDK
2042A	B84743A0060R176	1	TDK
2056A	B84243A6083Z000	1	TDK
2070A	B84243A6120Z000	1	TDK
2082A	B84243A6120Z000	1	TDK
2110A	B84243A0120Z000	1	TDK
2138A	B84243A6180Z000	1	TDK
2169A	B84243A0180Z000	1	TDK
2211A	B84743A0300R176	1	TDK
2257A	B84743A0300R176	1	TDK
2313A	B84743B0410S176	1	TDK
2360A	B84743B0410S176	1	TDK
2415A	B84743B0410S176	1	TDK

Table 3.22 External EMC Noise Filter (4xxxA)

Model	EMC Noise Filter Model	Quantity	Manufacturer
4002A	B84743A0008R176	1	TDK
4004A	B84743A0008R176	1	TDK
4005A	B84743A0008R176	1	TDK
4007A	B84743A0017R176	1	TDK
4009A	B84743A0017R176	1	TDK
4012A	B84743A0017R176	1	TDK
4018A	B84743A0033R176	1	TDK
4023A	B84743A0033R176	1	TDK
4031A	B84743A0044R176	1	TDK
4038A	B84743A0060R176	1	TDK
4044A	B84743A0060R176	1	TDK
4060A	B84743A0060R176	1	TDK
4075A	B84243A6083Z000	1	TDK
4089A	B84243A6120Z000	1	TDK
4103A	B84243A6120Z000	1	TDK
4140A	B84243A6180Z000	1	TDK

Model	EMC Noise Filter Model	Quantity	Manufacturer
4168A	B84243A6180Z000	1	TDK
4208A	B84743A0300R176	1	TDK
4250A	B84743A0300R176	1	TDK
4302A	B84743A0300R176	1	TDK
4371A	B84743B0410S176	1	TDK
4414A	B84743B0410S176	1	TDK
4477A	B84743A0660S176	1	TDK
4568A	B84743A0660S176	1	TDK
4605A	B84743A0660S176	1	TDK
4720A	B84743A1200S176	1	TDK

3.17 Wiring Checklist

Wire the drive, examine these items, then do a test run.

Table 3.23 Power Supply Voltage

Checked	No.	Item to Check
	1	The power supply voltage must be within the input voltage specification range of the drive.

Table 3.24 Main Circuit Wiring

Checked	No.	Item to Check
	1	<ul style="list-style-type: none"> Put the power supply through a molded-case circuit breaker (MCCB) before it gets to the drive input. Is an appropriate MCCB connected?
	2	Correctly wire the power supply to drive terminals R/L1, S/L2, and T/L3.
	3	Correctly wire the drive and motor together. The motor lines and drive output terminals U/T1, V/T2, and W/T3 must align to make the correct phase order. Note: If the phase order is incorrect, the drive will rotate in the opposite direction.
	4	Use 600 V heat resistant indoor PVC wire for the power supply and motor lines. Note: Wire gauge recommendations assume use of 600 V class 2 heat-resistant indoor PVC wire.
	5	Use the correct wire gauges for the main circuit. Note: <ul style="list-style-type: none"> When the wiring distance between the drive and the motor is long, use this formula for the voltage drop in the wire: $\text{Motor rated voltage (V)} \times 0.02 \geq \sqrt{3} \times \text{wire resistance } (\Omega/\text{km}) \times \text{wiring distance (m)} \times \text{motor rated current (A)} \times 10^{-3}$ When the cable between the drive and motor is longer than 50 m (164 ft), use parameter C6-02 [Carrier Frequency Selection] to decrease the carrier frequency.
	6	Correctly ground the drive.
	7	Tighten main circuit and grounding terminal screws of the drive to their specified torques.
	8	When operating more than one motor from one drive, set up overload protection circuits. <p style="text-align: center;"> A - Power supply C - oL1, oL2: Thermal overload relay B - Drive </p> Note: Set H1-03 = 25 [Terminal S3 Function Selection = External Fault (NC-Always-Coast)].
	9	When you use a braking resistor or a braking resistor unit, install an electromagnetic contactor (MC). Correctly install the resistor and make sure that overload protection uses the MC to shut off the power supply.
	10	Make sure that phase advancing capacitors, input noise filters, or ELCBs, GFCIs, RCM/RCDs are NOT installed on the output side of the drive.

Table 3.25 Control Circuit Wiring

Checked	No.	Item to Check
	1	Use twisted-pair cable for all drive control circuit wiring.
	2	Ground the shields of shielded wiring to the terminal E (G).
	3	For 3-Wire sequence, set parameters for MFDI terminals, and wire control circuits.
	4	Are the option cards installed correctly?
	5	Examine the drive for other wiring errors. Only use a multimeter to check wiring.
	6	Tighten the control circuit terminal screws of the drive to their specified torques.

Checked	No.	Item to Check
	7	Pick up all wire clippings.
	8	Make sure that none of the wires on the terminal block touch other terminals or connections.
	9	Is the control circuit wiring isolated from main circuit wiring by means of a duct or inside the control panel?
	10	Make sure that control circuit wiring is not longer than 50 m (164 ft).
	11	Make sure that Safe Disable input wiring is not longer than 30 m (98 ft).

3.18 Motor Application Precautions

◆ Precautions for Existing Standard Motors

■ Low-Speed Range

When a drive operates a standard motor, it will lose more power compared to operating the motor with a commercial power supply. In the low speed range, the temperature of the motor increases quickly because the motor cannot decrease its temperature when the speed decreases. In these conditions, decrease the load torque of the motor in the low-speed range. Figure 3.81 shows the permitted load characteristics for a Yaskawa standard motor. When 100% continuous torque is necessary at low speeds, use a motor designed to operate with a drive.

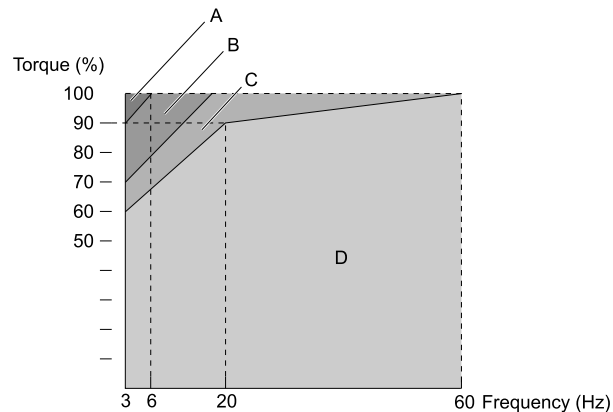

A - 25% ED (or 15 min)

B - 40% ED (or 20 min)

C - 60% ED (or 40 min)

D - Continuous operation

Figure 3.81 Permitted Load Characteristics for a Yaskawa Standard Motors

■ Insulation Withstand Voltage

Consider motor voltage tolerance levels and motor insulation in applications with an input voltage of over 440 V or particularly long wiring distances. Use an insulated drive motor.

NOTICE: Use an inverter-duty motor or vector-duty motor with reinforced insulation and windings applicable for use with an AC drive. If the motor does not have the correct insulation, it can cause a short circuit or ground fault from insulation deterioration.

■ High-Speed Operation

If you operate a motor more than its rated speed, you can have problems with the motor bearing durability and dynamic balance of the machine. Contact the motor or machine manufacturer.

■ Torque Characteristics

When you operate a motor with a drive, the torque characteristics are different than when you operate the motor directly from line power. Make sure that you know about the load torque characteristics for your application.

■ Vibration

Vibrations could occur in the these conditions:

- Resonance with the natural frequency of machinery
Use caution if you add a variable-speed drive to applications that operate the motor from line power at a constant speed. If resonance occurs, install shock-absorbing rubber around the base of the motor and enable the Jump frequency control.
- The motor is not balanced
Use caution if the motor speed is more than the rated motor speed.
- Subsynchronous resonance
Subsynchronous resonance can occur with long motor shafts and in applications such as turbines, blowers, and fans with high inertia loads.

Use Closed Loop Vector Control when these applications have subsynchronous resonance problems.

■ Audible Noise

The audible noise of the motor changes when the carrier frequency setting changes. When you use a high carrier frequency, audible noise from the motor is equivalent to the motor noise generated when you operate from line power. If you operate at speeds that are more than the rated rotation speed, the unwanted motor noise increases.

◆ Precautions for PM Motors

- Contact Yaskawa or your nearest sales representative to use a non-Yaskawa PM motor.
- You cannot operate a PM motor from a commercial power supply. If you must operate from a commercial power supply, use an induction motor.
- You cannot operate more than one PM motor from one drive. Use an induction motor and a variable-speed control drive.
- In Open Loop Vector Control for PM motor (OLV/PM), the motor can operate in the reverse direction for 1/2 turn (electrical angle) at start up.
- The quantity of generated starting torque changes when the control method and motor type change. Verify the starting torque, permitted load characteristics, impact load tolerance, and speed control range before you set up the motor with the drive. Contact Yaskawa or your nearest sales representative to use a motor that does not meet these specifications.
- In OLV/PM control, braking torque is always 125% or less when operating between 20% and 100% speed. A braking resistor unit will not change the value. Braking torque is 50% or less when operating at 20% speed or less.
- In OLV/PM control, the allowable load inertia moment is approximately 50 times higher than the motor inertia moment. Use Closed Loop Vector Control for PM motors for applications with a larger inertia moment.
- When you use a holding brake in OLV/PM control, release the brake before you start the motor. Failure to set the correct timing can cause a decrease in speed. Do not use these configurations in applications with heavy loads, for example conveyors or elevators.
- To restart a coasting motor that is rotating faster than 200 Hz in V/f Control, first use the Short Circuit Braking function to stop the motor. A special braking resistor unit is necessary for Short Circuit Braking. Contact Yaskawa or your nearest sales representative for more information.
To restart a coasting motor that is rotating slower than 200 Hz, use the Speed Search function.
If the motor cable is long, use Short Circuit Braking to stop the motor.

Note:

The Short Circuit Braking function uses the drive to forcefully cause a short across the motor wires to stop the motor before it has time to coast to a stop.

- You can also use EZ Open Loop Vector Control (EZOLV) to operate synchronous reluctance motors (SynRM). Contact Yaskawa or your nearest sales representative for more information.
- After you replace a failed PM motor encoder, make sure that the motor can rotate and do Z Pulse Offset Tuning or PM Rotational Auto-Tuning.
- If *oC* [Overcurrent], *STPo* [Motor Step-Out Detected], or *LSo* [Low Speed Motor Step-Out] occur during restart, retry Speed Search and use the Short Circuit Braking function when starting to adjust the motor.

◆ Precautions for Specialized Motors

■ Pole Change Motors

The rated current of pole change motors is different than standard motors. Check the maximum current of the motor before you select a drive. Always stop the motor before you switch between the number of motor poles. If you change the number of poles while the motor is rotating, the overvoltage from regeneration or the overcurrent protection circuitry will make the motor coast to stop.

■ Submersible Motors

The rated current of a submersible motor is more than the rated current of a standard motor. Use a sufficiently large motor cable that will not let voltage drop decrease the maximum torque level.

■ Explosion-Proof Motors

You must test the motor and the drive together for explosion-proof certification. You must also test existing installations of explosion-proof motors. The drive is not designed for explosion-proof areas. Install the drive in a safe location.

The encoder used with pressure-resistant explosion-proof motors is intrinsically safe. When wiring between the drive and encoder, always connect through a specialized pulse coupler.

■ Geared Motors

The continuous speed range is different for different lubricating methods and manufacturers. For oil lubrication, continuous operation in the low-speed range can cause burnout. Contact the manufacturer for more information about applications where operating at more than the rated frequency is necessary.

■ Single-Phase Motors

Variable speed drives are not designed to operate with single-phase motors. The drive is for use with three-phase motors only. If you use capacitors to start the motor, it can cause a high frequency current to flow to the capacitors and can damage the capacitors. A split-phase start or a repulsion start can burn out the starter coils because the internal centrifugal switch is not activated.

■ Motors with Brakes

If you use a drive to operate a motor that has a brake connected to the output side, low voltage levels can cause the brake to possibly not release at start. Use a motor with a brake that has a dedicated source of power for the brake. Connect the brake power supply to the power supply side of the drive. Motors with built-in brakes make noise when operating at low speeds.

◆ Notes on the Power Transmission Mechanism

For power transmission machinery that uses oil to lubricate gearboxes, transmissions, or reduction gears, make sure that you use precaution if you operate the machinery continuously at low speed. Oil does not lubricate the system as well at low speeds. If you operate at frequencies higher than the rated frequency, it can cause problems with the power transmission mechanism. These problems include audible noise, decreased service life, and decreased durability.

Startup Procedure and Test Run

4.1	Section Safety	134
4.2	Keypad: Names and Functions.....	135
4.3	LED Status Ring.....	141
4.4	Start-up Procedures	143
4.5	Items to Check before Starting Up the Drive.....	149
4.6	Keypad Operation	151
4.7	Automatic Parameter Settings Optimized for Specific Applications (Application Presets).....	189
4.8	Auto-Tuning	191
4.9	Test Run	200
4.10	Fine Tuning during Test Runs (Adjust the Control Function).....	202
4.11	Test Run Checklist	209

4.1 Section Safety

DANGER

Electrical Shock Hazard

Do not examine, connect, or disconnect wiring on an energized drive. Before servicing, disconnect all power to the equipment and wait for the time specified on the warning label at a minimum. The internal capacitor stays charged after the drive is de-energized. The charge indicator LED extinguishes when the DC bus voltage decreases below 50 Vdc. When all indicators are OFF, remove the covers before measuring for dangerous voltages to make sure that the drive is safe.

If you do work on the drive when it is energized, it will cause serious injury or death from electrical shock. The drive has internal capacitors that stay charged after you de-energize the drive.

WARNING

Electrical Shock Hazard

Do not operate the drive when covers are missing. Replace covers and shields before you operate the drive. Use the drive only as specified by the instructions.

Some figures in this section include drives without covers or safety shields to more clearly show the inside of the drive. If covers or safety shields are missing from the drive, it can cause serious injury or death.

Do not remove covers or touch circuit boards while the drive is energized.

If you touch the internal components of an energized drive, it can cause serious injury or death.

4.2 Keypad: Names and Functions

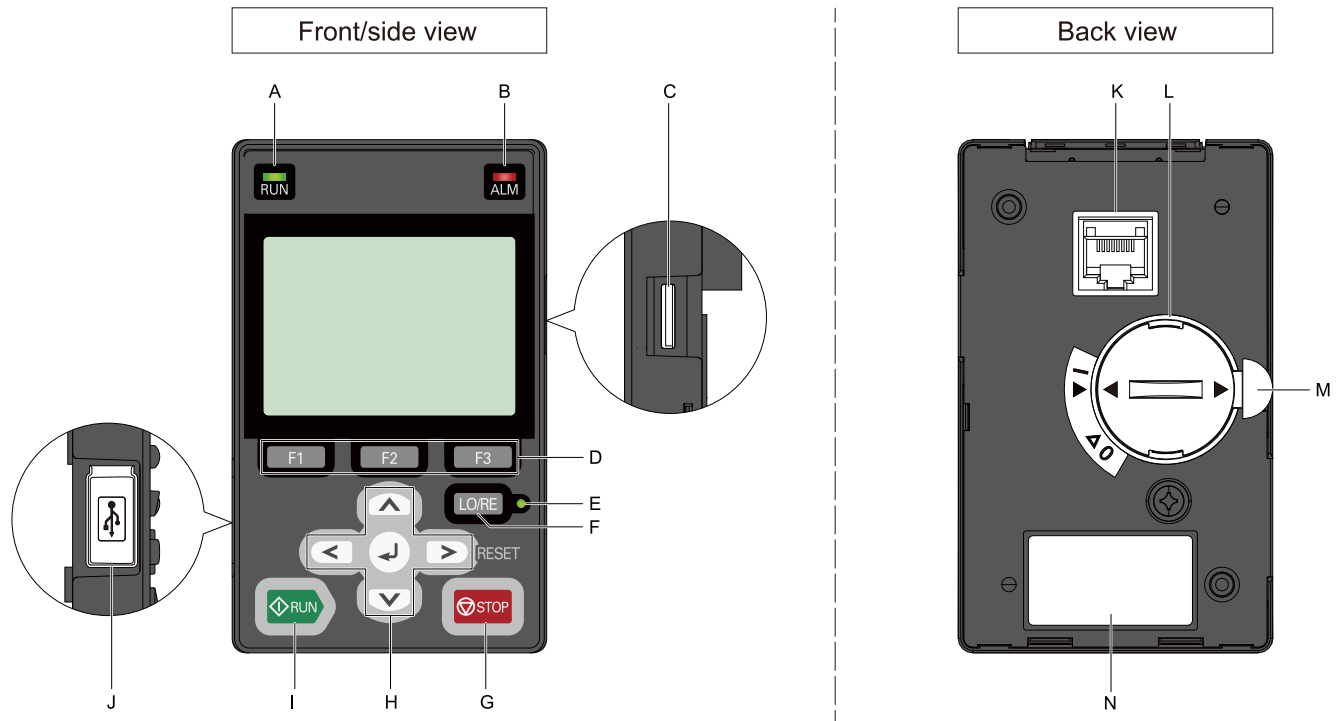

















Figure 4.1 Keypad

Table 4.1 Keypad: Names and Functions

No.	Name	Function
A	RUN LED 	Illuminates to show that the drive is operating the motor. The LED turns OFF when the drive stops. Flashes to show that: <ul style="list-style-type: none"> The drive is decelerating to stop. The drive received a Run command but the frequency reference is 0 Hz. Flashes quickly to show that: <ul style="list-style-type: none"> The drive received a Run command from the Multi-Function Digital Input (MFDI) terminals and is switching to REMOTE Mode while the drive is in LOCAL Mode. The drive received a Run command from the MFDI terminals when the drive is not in Drive Mode. The drive received a Fast Stop command. The safety function shuts off the drive output. The user pushed  on the keypad while the drive is operating in REMOTE Mode. The drive is energized with an active Run command and $b1-17 = 0$ [Run Command at Power Up = Disregard Existing RUN Command].
B	ALM LED 	Illuminates when the drive detects a fault. Flashes when the drive detects: <ul style="list-style-type: none"> Alarm An oPE parameter setting error A fault or alarm during Auto-Tuning The light switches off when the drive is in normal operation. There is no fault or alarm.
C	microSD Card Insertion Slot	The insertion point for a microSD card.
D	Function Keys (F1, F2, F3) 	The menu shown on the keypad sets the functions for function keys. The name of each function is in the lower half of the display window.
E	LO/RE LED 	Illuminated: The keypad controls the Run command (LOCAL Mode). OFF: The control circuit terminal or serial transmission device controls the Run command (REMOTE Mode). Note: <ul style="list-style-type: none"> LOCAL: Operated using the keypad. Use the keypad to enter Run/Stop commands and the frequency reference command. REMOTE: Operated from the control circuit terminal or serial transmission. Use the frequency reference source entered in $b1-01$ and the Run command source selected in $b1-02$.

4.2 Keypad: Names and Functions

No.	Name	Function
F	LO/RE Selection Key 	Switches drive control for the Run command and frequency reference between the keypad (LOCAL) and an external source (REMOTE). Note: <ul style="list-style-type: none"> • Stop operation to enable the LO/RE Selection Key when in Drive Mode. Set $o2-01 = 0$ [<i>LO/RE Key Function Selection = Disabled</i>] to disable  when switching from REMOTE to LOCAL will have a negative effect on system performance. • The drive will not switch between LOCAL and REMOTE when it is receiving a Run command from an external source.
G	STOP Key 	Stops drive operation. Note: The STOP key has highest priority. Push  to stop the motor even when a Run command (REMOTE Mode) is active at any external Run command source. Set $o2-02 = 0$ [<i>STOP Key Function Selection = Disabled</i>] to disable the priority in  .
H	Left Arrow Key 	Moves the cursor to the left.
	Up Arrow Key/Down Arrow Key 	<ul style="list-style-type: none"> • Scrolls up or down to display the next item or the previous item. • Selects parameter numbers, and increments or decrements setting values.
	Right Arrow Key (RESET) 	<ul style="list-style-type: none"> • Moves the cursor to the right. • Continues to the next screen. • Clears drive faults.
	ENTER Key 	<ul style="list-style-type: none"> • Enters parameter values and settings. • Selects menu items to move the user between keypad displays. • Selects each mode, parameter, and set value.
I	RUN Key 	Starts the drive in LOCAL mode. Starts the motor tuning procedure in Auto-Tuning Mode. Note: Push  on the keypad to set the drive to LOCAL Mode before using the keypad to operate the motor.
J	USB Terminal	Insertion point for a mini USB cable. Uses a USB cable (USB standard 2.0, type A - mini-B) to connect the keypad to a PC.
K	RJ-45 Connector	Connects to the drive using an RJ-45 8-pin straight through UTP CAT5e extension cable or keypad connector.
L	Clock Battery Cover	Cover for the clock battery. Note: <ul style="list-style-type: none"> • The battery included with the keypad is for operation check. It may be exhausted earlier than the expected battery life described in the manual. • Refer to "Maintenance & Troubleshooting Manual (TOEPYAIGA8001)" for details on replacement procedure. To replace the battery, use a Hitachi Maxell "CR2016 Lithium Manganese Dioxide Lithium Battery" or an equivalent battery with these properties: <ul style="list-style-type: none"> • Nominal voltage: 3 V • Operating temperature range: -20°C to +85°C (-4°F to +185°F)
M	Insulation Sheet	An insulating sheet is attached to the keypad battery to prevent battery drain. Remove the insulation sheet before you use the keypad for the first time.
N	Nameplate	Shows the model, lot number, and FLASH number of the keypad. Note: Make sure that you use a keypad with FLASH number 1004 or later. Keypads with FLASH numbers 1003 and earlier will not show characters correctly.

WARNING! Sudden Movement Hazard. If you change the control source when $b1-07 = 1$ [*LOCAL/REMOTE Run Selection = Accept Existing RUN Command*], the drive can start suddenly. Before you change the control source, remove all personnel from the area around the drive, motor, and load. Sudden starts can cause serious injury or death.

◆ LCD Display

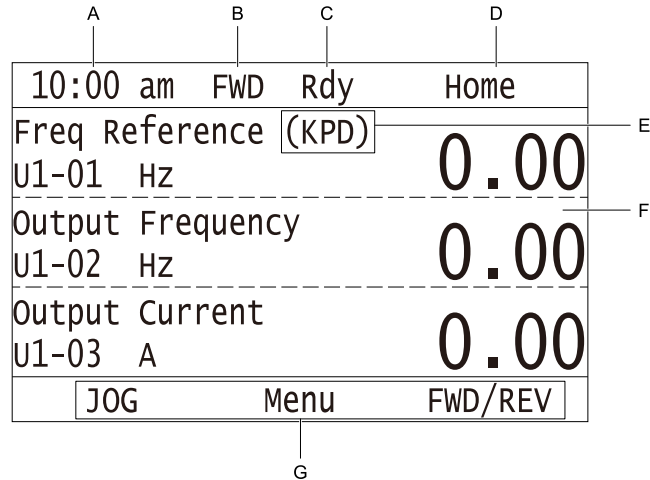







Figure 4.2 LCD Display Indications

Table 4.2 LCD Display Indications and Meanings

Symbol	Name	Description
A	Time display area	Shows the current time. Set the time on the default settings screen.
B	Forward run/Reverse indication	Shows direction of motor rotation. <ul style="list-style-type: none"> • FWD: Shown when set to Forward run. • REV: Shown when set to Reverse run. Note: In DriveWorksEZ operation, FWD or REV flash.
C	Ready	The screen will show Rdy when the drive is ready for operation or when the drive is running.
D	Mode display area	Shows the name of the current mode or screen.
E	Frequency reference source indicator	Shows the current frequency reference source. <ul style="list-style-type: none"> • KPD: keypad • AI: analog input terminal (terminals A1 to A3) • COM: MEMOBUS/Modbus communications • OPT: option card • RP: pulse train input terminal (terminal RP)
F	Data display area	Shows parameter values, monitor values, and details of the results of operations.
G	Function keys 1 to 3 (F1 to F3)	The function names shown in this area will change when the selected screen changes. Push one of the function keys  to  on the keypad to do the function.

◆ Indicator LEDs and Drive Status

LED	Display	Drive Status
RUN LED 	Illuminated	The drive is operating the motor.
	Flashing	<ul style="list-style-type: none"> The drive is decelerating to stop. The drive received a Run command with a frequency reference of 0 Hz, but the drive is not set for zero speed control. The drive received a DC Injection Braking command.
	Flashing Quickly	<ul style="list-style-type: none"> The drive received a Run command from the MFDI terminals and is switching to REMOTE Mode while the drive is in LOCAL Mode. The drive received a Run command from an external source and the drive is not in Drive Ready (READY) condition. The drive received a Fast Stop command. The safety function shut off the drive output. You pushed  on the keypad while the drive is operating in REMOTE Mode. The drive is energized with an active Run command and $b1-17 = 0$ [Run Command at Power Up = Disregard Existing RUN Command]. When $b1-03 = 3$ [Stopping Method Selection = Coast to Stop with Timer], the Run command is disabled then enabled during the Run wait time. The drive received a DC Injection Braking command. The voltage of the main circuit power supply decreased, and the 24 V power supply is supplying power only the the drive.
	OFF	The motor is stopped.
ALM LED 	Illuminated	The drive detects a fault.
	Flashing	The drive detected one of the following: <ul style="list-style-type: none"> An alarm An oPE parameter setting error A fault or error during Auto-Tuning Note: The digital characters displayed on the keypad will also flash.
	OFF	There are no drive faults or alarms.
LO/RE LED 	Illuminated	The keypad controls the Run command (LOCAL Mode).
	OFF	The control circuit terminal or serial transmission device controls the Run command (REMOTE Mode).

■ LED Flashing Statuses

Refer to Figure 4.3 for information about the differences between flashing and “flashing quickly”.

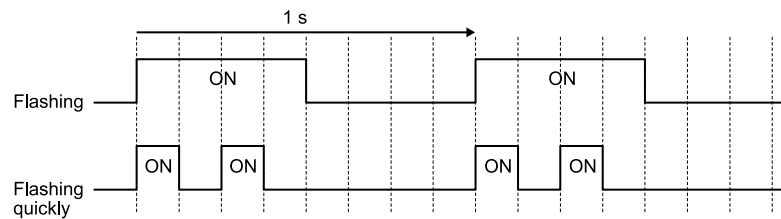

Figure 4.3 LED Flashing Statuses

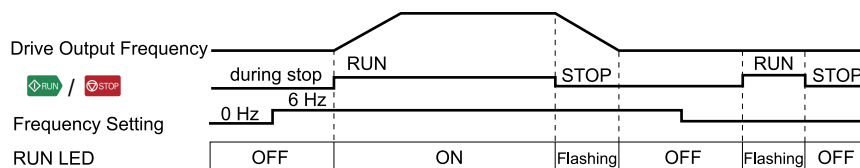
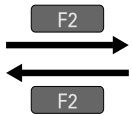

Figure 4.4 Relation between RUN indicator and Drive Operation

◆ Keypad Mode and Menu Displays

10:00 am FwD Rdy Home	
Freq Reference (AI)	0.00
U1-01 Hz	0.00
Output Frequency	0.00
U1-02 Hz	0.00
Output Current	0.00
U1-03 A	0.00
Menu	

HOME



10:00 am FwD Rdy Menu
Monitors
Parameters
User Custom Parameters
Parameter Backup/Restore
Modified Param / Fault Log
Auto-Tuning
Home

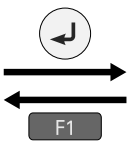

10:00 am FwD Rdy Monitor
Standard Monitor
Custom Monitor
Bar Graph
Analog Gauge
Trend Plot
Back Home

Monitors

Drive Mode

10:00 am FwD Menu
Monitors
Parameters
User Custom Parameters
Parameter Backup/Restore
Modified Param / Fault Log
Auto-Tuning
Home

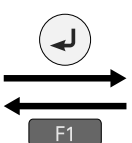

10:00 am FwD Parameters
Initialization Parameters
Application
Tuning
References
Motor Parameters
Options
Back Home

Parameters

10:00 am FwD Menu
Monitors
Parameters
User Custom Parameters
Parameter Backup/Restore
Modified Param / Fault Log
Auto-Tuning
Home

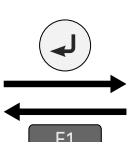

10:00 am FwD Parameters
Application Preset
A1-06 0 (0)
Control Method Selection
A1-02 2 (2)
Frequency Reference Selection 1
b1-01 1 (1)
Back Home

User Custom Parameters

10:00 am FwD Menu
Monitors
Parameters
User Custom Parameters
Parameter Backup/Restore
Modified Param / Fault Log
Auto-Tuning
Home

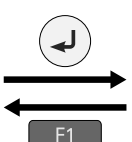

10:00 am FwD Backup
Select Items to Backup/Restore
Standard Parameters
Back Home

Parameter Backup/Restore

10:00 am FwD Menu
Monitors
Parameters
User Custom Parameters
Parameter Backup/Restore
Modified Param / Fault Log
Auto-Tuning
Home

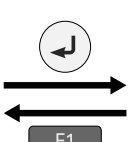

10:00 am FwD History
Modified Parameters
Fault Log
Back Home

Modified Parameters/Fault Log

10:00 am FwD Menu
Parameters
User Custom Parameters
Parameter Backup/Restore
Modified Param / Fault Log
Auto-Tuning
Initial Setup
Home

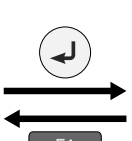

10:00 am FwD Auto Tuning
Select Auto-Tuning mode
Motor Parameter Tuning
Back Home

Auto-Tuning

10:00 am FwD Menu
User Custom Parameters
Parameter Backup/Restore
Modified Param / Fault Log
Auto-Tuning
Initial Setup
Diagnostic Tools
Home

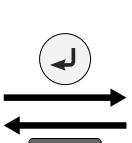

10:00 am FwD Init Setup
Language Selection
Set Date/Time
Setup wizard
Show Initial Setup Screen
Back Home

Initial Setup

10:00 am FwD Menu
User Custom Parameters
Parameter Backup/Restore
Modified Param / Fault Log
Auto-Tuning
Initial Setup
Diagnostic Tools
Home

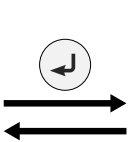

10:00 am FwD Tools
Data Logger
Backlight
Drive Information
Back Home Setup

Diagnostic Tools

Programming Mode

Startup Procedure and Test Run

Figure 4.5 Keypad Functions and Display Levels

4.2 Keypad: Names and Functions

Note:



- Energize the drive with factory defaults to show the Initial Setup screen. Push **F2** (Home) to show the HOME screen.
 - Select [No] from the [Show Initial Setup Screen] setting to not display the Initial Setup screen.
- Push  from the Home screen to show drive monitors.
- Push  to set *d1-01 [Reference 1]* when the Home screen shows *U1-01 [Frequency Reference]* in LOCAL Mode.
- The keypad will show [Rdy] when the drive is in Drive Mode. The drive is prepared to accept a Run command.
- The drive will not accept a Run command in Programming Mode in the default setting. Set *b1-08 [Run Command Select in PRG Mode]* to accept or reject a Run command from an external source while in Programming Mode.
 - Set *b1-08 = 0 [Disregard RUN while Programming]* to reject the Run command from an external source while in Programming Mode (default).
 - Set *b1-08 = 1 [Accept RUN while Programming]* to accept the Run command from an external source while in Programming Mode.
 - Set *b1-08 = 2 [Allow Programming Only at Stop]* to prevent changes from Drive Mode to Programming Mode while the drive is operating.

Table 4.3 Drive Mode Screens and Functions

Mode	Keypad Screen	Function
Drive Mode	Monitors	Sets monitor items to display.
Programming Mode	Parameters	Changes parameter settings.
	User Custom Parameters	Shows the User Parameters.
	Parameter Backup/Restore	Saves parameters to the keypad as backup.
	Modified Parameters/Fault Log	Shows modified parameters and fault history.
	Auto-Tuning	Auto-Tunes the drive.
	Initial Setup	Changes initial settings.
	Diagnostic Tools	Sets data logs and backlight.

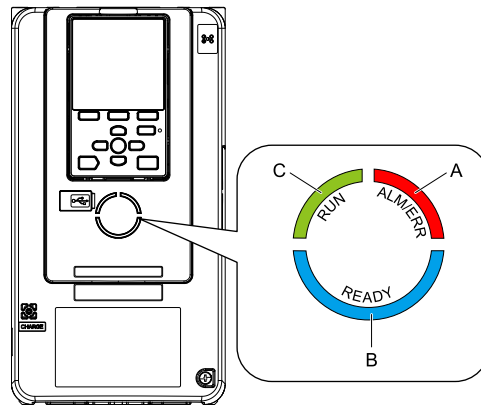

4.3 LED Status Ring

The LED Status Ring on the drive cover shows the drive operating status.



A - ALM/ERR
B - Ready

C - RUN

LED	Status	Description	
A	ALM/ERR	Illuminated	The drive detects a fault.
		Flashing ^{*1}	The drive detects: <ul style="list-style-type: none"> An alarm An oPE parameter setting error An Auto-Tuning error Note: The LED will illuminate to identify a fault if the drive detects a fault and an alarm at the same time.
		OFF	There are no drive faults or alarms.
B	Ready	Illuminated	The drive is operating or is prepared for operation.
		Flashing ^{*1}	The drive is in <i>Sto</i> [<i>Safe Torque OFF</i>] condition.
		Flashing Quickly ^{*1}	The voltage of the main circuit power supply dropped, and only the external 24 V power supply provides the power to the drive.
		OFF	<ul style="list-style-type: none"> The drive detects a fault. There is no fault and the drive received a Run command, but the drive cannot operate. For example, in Programming Mode or when  is flashing.
C	RUN	Illuminated	The drive is in regular operation.
		Flashing ^{*1}	<ul style="list-style-type: none"> The drive is decelerating to stop. The drive received a Run command with a frequency reference of 0 Hz, but the drive is not set for zero speed control. The drive received a DC Injection Braking command.
		Flashing Quickly ^{*1}	<ul style="list-style-type: none"> The drive received a Run command from the MFDI terminals and is switching to REMOTE Mode while the drive is in LOCAL Mode. The drive received a Run command from the MFDI terminals when the drive is not in Drive Mode. The drive received a Fast Stop command. The safety function shuts off the drive output. The user pushed  on the keypad while the drive is operating in REMOTE Mode. The drive is energized with an active Run command and $b1-17 = 0$ [<i>Run Command at Power Up = Disregard Existing RUN Command</i>]. The drive is set to coast-to-stop with timer ($b1-03 = 3$ [<i>Stopping Method Selection = Coast to Stop with Timer</i>]), and the Run command is disabled then enabled during the Run wait time.
		OFF	The motor is stopped.

*1 Refer to [Figure 4.6](#) for the difference between “flashing” and “flashing quickly”.

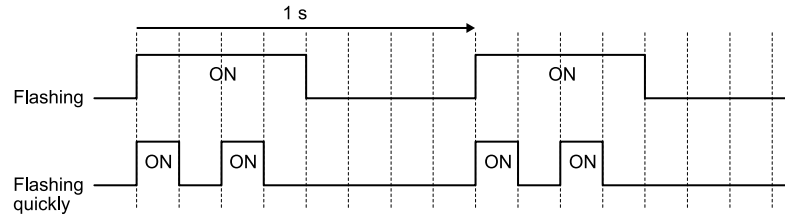

Figure 4.6 LED Flashing Statuses

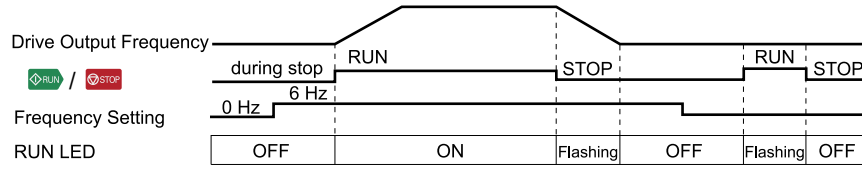

Figure 4.7 Relation between RUN LED and Drive Operation

4.4 Start-up Procedures

This section gives the basic steps necessary to start up the drive.

Use the flowcharts in this section to find the most applicable start-up method for your application.

This section gives information about only the most basic settings.

Note:

Refer to the *A1-06* section to use an Application Preset to set up the drive.

◆ Flowchart A: Connect and Run the Motor with Minimum Setting Changes

Flowchart A shows a basic start-up sequence to connect and run a motor with a minimum of setting changes. Settings can change when the application changes.

Use the drive default parameter settings for basic applications where high precision is not necessary.

4.4 Start-up Procedures

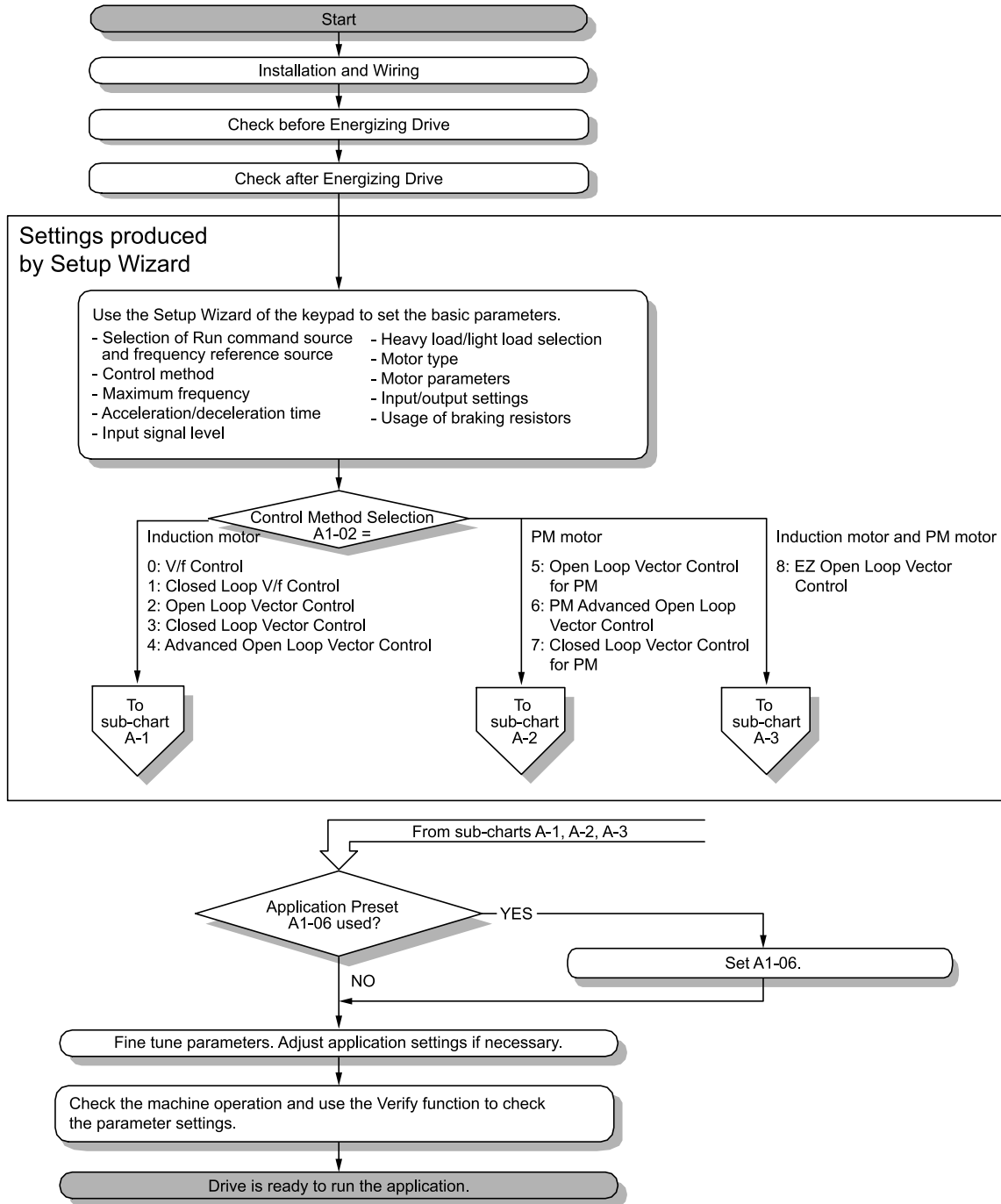
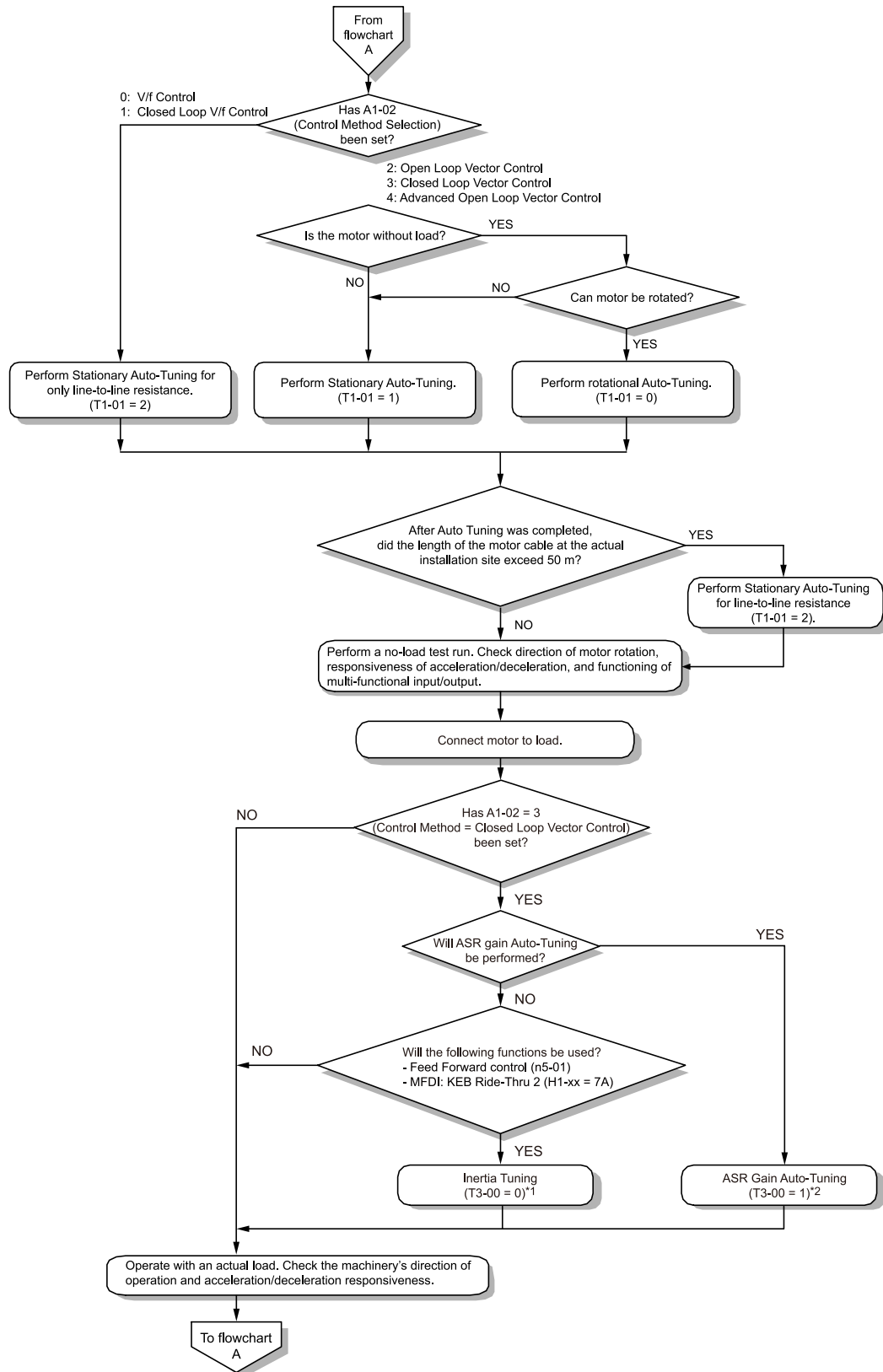

Figure 4.8 Basic Steps before Startup

◆ Sub-Chart A-1: Induction Motor Auto-Tuning and Test Run Procedure



Startup Procedure and Test Run

Figure 4.9 Induction Motor Auto-Tuning and Test Run Procedure

- *1 Be sure to release the holding brake before doing Inertia Tuning.
- *2 In ASR Tuning, the drive will automatically tune Feed Forward control and KEB Ride-Thru 2 parameters.

◆ Sub-Chart A-2: PM Motor Auto-Tuning and Test Run Procedure

Sub-Chart A-2 gives the basic steps to start up the drive for a PM motor.

Note:

1. Although Auto-Tuning will set parameters for speed control with an encoder, set *F1-05 [PG 1 Rotation Selection]* before starting Auto-Tuning.
2. If you replace the encoder, do Z Pulse Offset Tuning.

WARNING! *Crush Hazard. Test the system to make sure that the drive operates safely after you wire the drive and set parameters. If you do not test the system, it can cause damage to equipment or serious injury or death.*

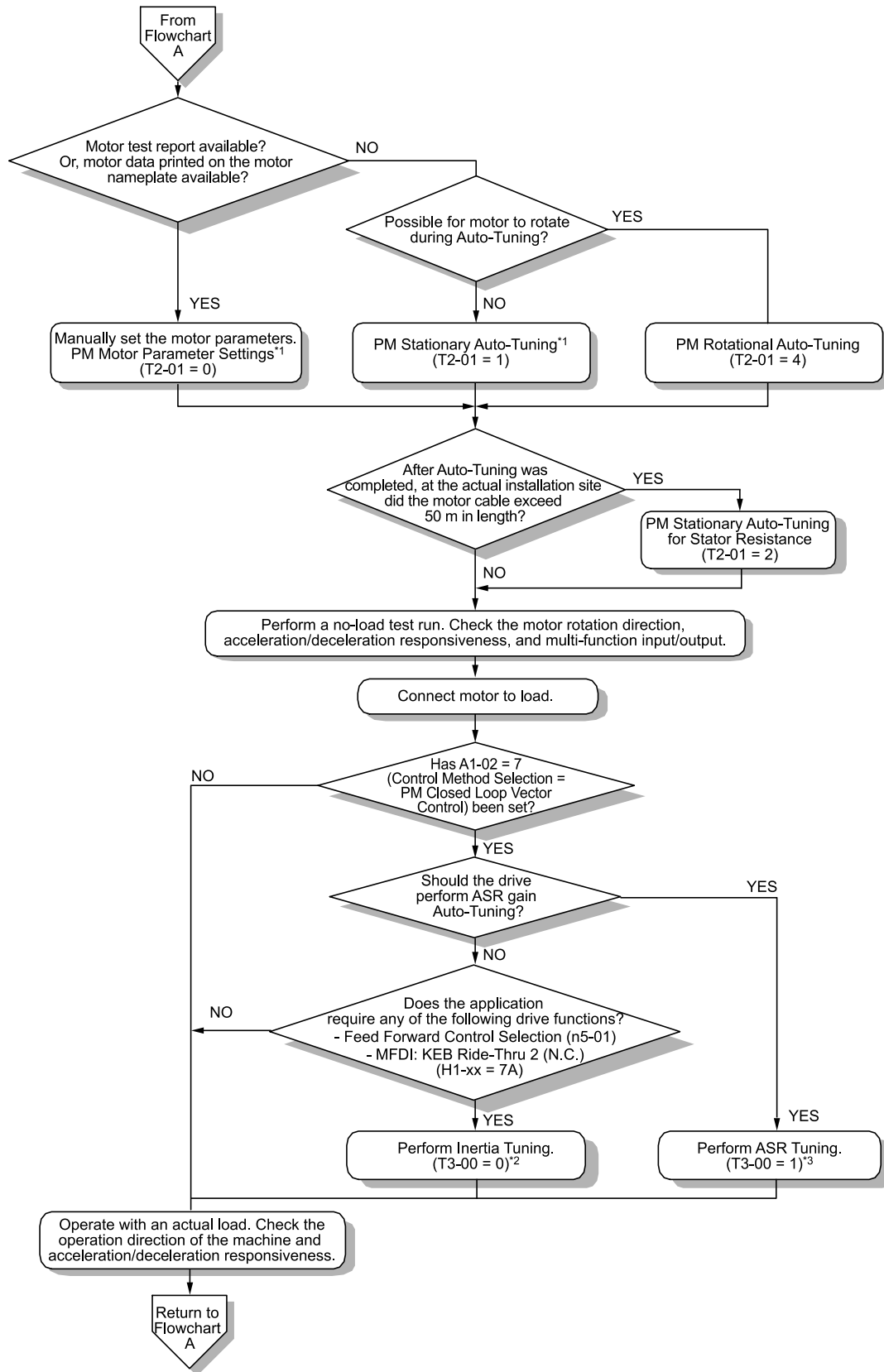

Figure 4.10 PM Motor Auto-Tuning and Test Run Procedure

- *1 For Yaskawa PM motors (SMRA-series, SSR1-series, or SST4-series), set E5-01 (Motor Code). For PM motors from a different manufacturer, set E5-01 = FFFF.
- *2 Be sure to release the holding brake before doing Inertia Tuning.
- *3 In ASR Tuning, the drive will automatically tune Feed Forward control and KEB Ride-Thru 2 parameters.

◆ Subchart A-3: EZ Open Loop Vector Control Test Run Procedure

Subchart A-3 gives the setup procedure to run a PM motor in EZ Open Loop Vector Control.

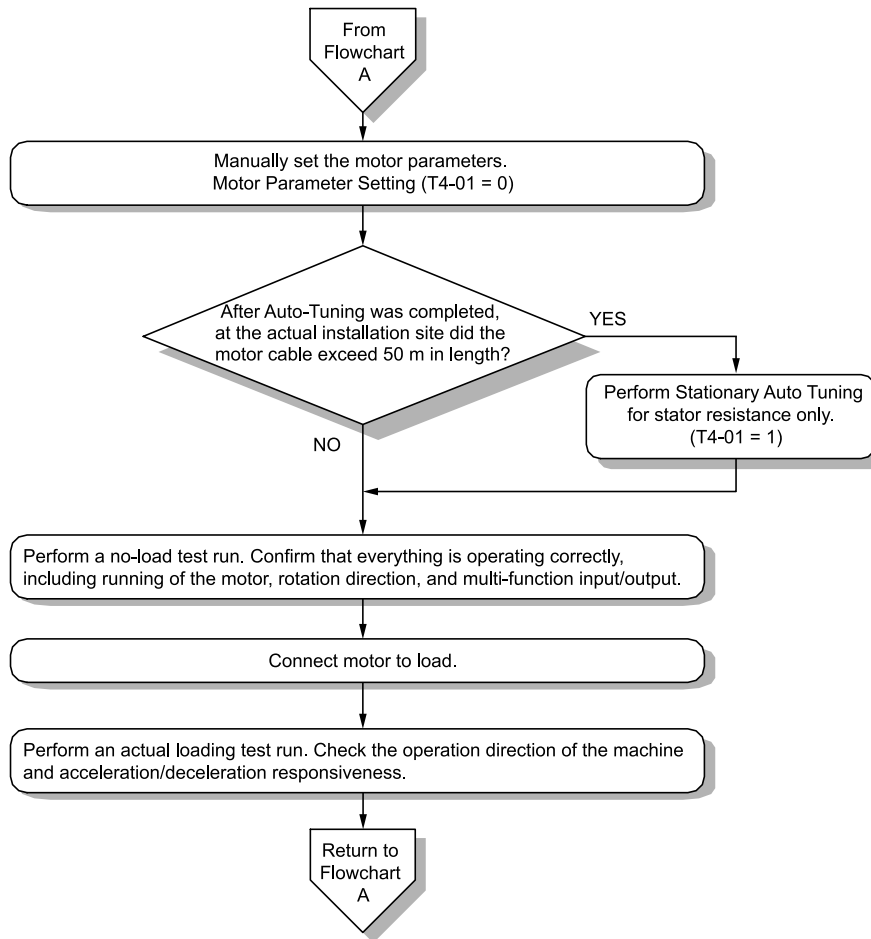

Figure 4.11 Procedure for Test Run of EZ Open Loop Vector Control Method

4.5 Items to Check before Starting Up the Drive

◆ Check before Energizing the Drive

Examine the items in [Table 4.4](#) before you energize the drive.

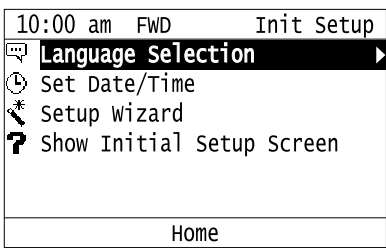
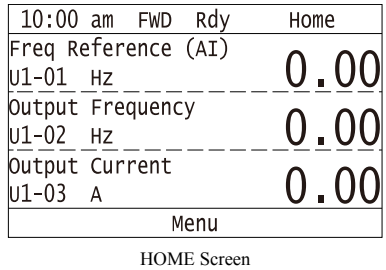
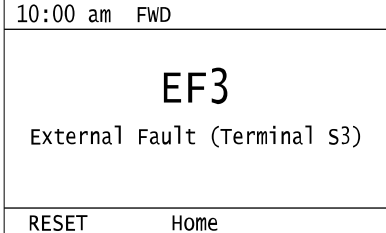



Table 4.4 Items to Check before Energizing the Drive

Items to Check	Description
Input Power Supply Voltage	The voltage of the input power supply must be: 200 V class: three-phase 200 Vac to 240 Vac 50/60 Hz, 270 Vdc to 340 Vdc 400 V class: three-phase 380 Vac to 480 Vac 50/60 Hz, 510 Vdc to 680 Vdc
	Correctly and safely wire power supply input terminals R/L1, S/L2, T/L3.
	Correctly ground the drive and motor.
Connection between Drive Output Terminals and Motor Terminals	Make sure that you connected drive output terminals U/T1, V/T2, and W/T3 in the correct sequence to agree with motor terminals U, V, and W without loosened screws.
Control Circuit Terminal Wiring	Make sure that you connected the drive control circuit terminals in the correct sequence to agree with devices and switches without loosened screws.
Control Circuit Terminal Status	Turn OFF the inputs from all devices and switches connected to the drive control circuit terminals.
Connection between Machinery and Motor	Disengage all couplings and belts that connect the motor and machinery.

◆ Check after Energizing the Drive

Examine the items in [Table 4.5](#) after you energize the drive. The keypad will show these screens depending on the drive status.

Table 4.5 Display Status after Energizing the Drive

Status	Display	Description
During Usual Operation	 <p>Initial Setup Screen or</p>  <p>HOME Screen</p>	<ul style="list-style-type: none"> The data display area will show the Initial Setup screen or the HOME screen Energize the drive with factory defaults to show the Initial Setup screen. Select [No] from the [Show Initial Setup Screen] settings to show the HOME screen without showing the Initial Setup screen.
When the Drive Detects a Fault		<p>The display changes depending on the fault. Refer to "Troubleshooting" to remove the cause of the fault.</p>  will illuminate. Note: If the screen shows a different screen, do these steps to show the fault content again: <ol style="list-style-type: none"> Push  from the HOME screen. Push  (Home) from a different screen than the HOME screen.

4.5 Items to Check before Starting Up the Drive

Note:

Make sure that you use a keypad with FLASH number 1004 or later. Keypads with FLASH numbers 1003 and earlier will not show characters correctly.

◆ Make the Initial Settings

The keypad will show the Initial Setup screen when energizing the drive for the first time. Users can set the date and time or the language to show on the keypad. The Setup Wizard prepares the drive for operation, from setting the basic parameters to performing Auto-Tuning. Refer to [Set Parameters Using the Setup Wizard on page 179](#) for more information.

Note:

If the keypad does not show the Initial Setup screen, [Initial Setup] from the Main Menu to show the Initial Setup screen.

1. Make the initial settings for each item.

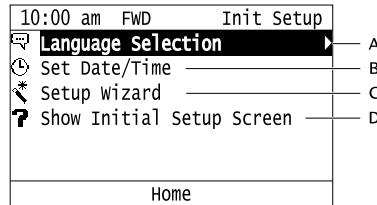

A - Language Selection
B - Set Date/Time

C - Setup Wizard
D - Show Initial Setup Screen

Note:

If you select [Yes] from the [Show Initial Setup Screen] setting, the keypad will show the Initial Setup screen each time the drive is energized.

If you select [NO], the keypad will not show the Initial Setup screen each time the drive is energized, starting with the next time.

2. Push **F2** (Home).

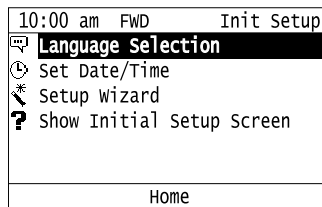

The display shows the HOME screen.

4.6 Keypad Operation

Note:

Make sure that you use a keypad with FLASH number 1004 or later. Keypads with FLASH numbers 1003 and earlier will not show characters correctly.

◆ Home Screen Display Selection

This section gives information about the functions that you can control from the HOME screen and the content shown on the HOME screen.



10:00 am	FWD Rdy	Home
Freq Reference(KPD)		0.00
U1-01	Hz	0.00
Output Frequency		0.00
U1-02	Hz	0.00
Output Current		0.00
U1-03	A	0.00
JOG	Menu	FWD/REV

■ View Monitors Shown in Home Screen

This figure shows monitor data in the data display area of the HOME screen.

10:00 am	FWD Rdy	Home
Freq Reference (KPD)		0.00
U1-01	Hz	0.00
Output Frequency		0.00
U1-02	Hz	0.00
Output Current		0.00
U1-03	A	0.00
JOG	Menu	FWD/REV

Monitor

- To change what the screen shows, change the setting for *o1-40 [Home display selection]*.
- When *o1-40 [Home display selection]* is set to “Custom Monitor”, and there is more than one screen, use  or  to switch between screens.

■ JOG Operation

Push  to illuminate . Push and hold  (JOG) to run the motor. Release  to stop the motor.

■ Change Motor between Forward/Reverse Run

You can change the direction of motor rotation when you use the keypad to operate the drive. Push  to illuminate





Push and hold  (FWD/REV) to toggle the direction of motor rotation between forward and reverse.

■ Show the Standard Monitor

Push  to show the standard monitor (*Ux-xx*). Push  (HOME) to go back to the HOME screen.

Note:

When a fault, minor fault, or an error occurs, push  to show the content of the fault. Push  again to show the standard monitor (*Ux-xx*).

■ Change the Frequency Reference Value

1. Push  to access the screen to change the frequency.

4.6 Keypad Operation

2. Push or to select the digit, then push or to change the value.
3. Push to keep the changes.

Note:

The HOME screen must show *U1-01 [Frequency Reference]* or you must set the keypad as the Run command source (REMOTE) to use this function.

■ Show the Main Menu

Push to show the main menu. Push (HOME) to go back to the HOME screen.

10:00 am FWD Rdy	Menu
Monitors	
Parameters	
User Custom Parameters	
Parameter Backup/Restore	
Modified Param / Fault Log	
Auto-Tuning	
Home	

◆ Showing the Monitor

This section shows how to show the standard monitors (*Ux-xx*).

1. Push (Home) to show the HOME screen.

Note:

- When the drive is in HOME Mode, the screen shows [Home] in the upper right-hand corner of the screen.
- If the screen does not show [Home] for , push (Back), and then push to show [Home].

2. Push (Menu).



10:00 am FWD Rdy	Home
Freq Reference (AI)	0.00
U1-01 Hz	
Output Frequency	
U1-02 Hz	0.00
Output Current	
U1-03 A	0.00
Menu	

3. Push or to select [Monitors], then push .



10:00 am FWD Rdy	Menu
Monitors	
Parameters	
User Custom Parameters	
Parameter Backup/Restore	
Modified Param / Fault Log	
Auto-Tuning	
Home	

4. Push or to select [Standard Monitor], then push .

10:00 am FWD Rdy	Monitor
Standard Monitor	
Custom Monitor	
Bar Graph	
Analog Gauge	
Trend Plot	
Back	Home

5. Push  or  to select monitor group, then push .

10:00 am	FWD	Rdy	Monitor
U1 Operation Status Monitors ▶			
U2 Fault Trace			
U3 Fault History			
U4 Maintenance Monitors			
U5 PID Monitors			
U6 Operation Status Monitors			
Back		Home	

6. Push  or  to change the monitor number to show the monitor item.

Note:

Push  to go back to the previous page.



10:00 am	FWD	Rdy	Monitor
Terminal A1 Input Lv			0.0
U1-13 %			0.0
Terminal A2 Input Lv			0.0
U1-14 %			0.0
Terminal A3 Input Lv			0.0
U1-15 %			0.0
Home			

◆ Set Custom Monitors

You can select and register a maximum of 12 monitoring items to regularly show on the keypad. This procedure shows how to set the motor speed to [Custom Monitor 1].

1. Push  (Home) to show the HOME screen.

Note:

- The keypad will show [Home] in the top right corner when the HOME screen is active.
- If the keypad does not show [Home] on , push  (Back) to show [Home] on .

2. Push  (Menu).

10:00 am	FWD	Rdy	Home
Freq Reference (AI)			0.00
U1-01 HZ			0.00
Output Frequency			0.00
U1-02 HZ			0.00
Output Current			0.00
U1-03 A			0.00
Menu			

3. Push  or  to select [Monitors], then push .

10:00 am	FWD	Rdy	Menu
Monitors ▶			
Parameters			
User Custom Parameters			
Parameter Backup/Restore			
Modified Param / Fault Log			
Auto-Tuning			
Home			

4. Push  or  to select [Custom Monitor], then push  (Setup).

10:00 am	FWD	Rdy	Monitor
Standard Monitor			
Custom Monitor ▶			
Bar Graph			
Analog Gauge			
Trend Plot			
Back		Home Setup	

5. Push  or  to select [Custom Monitor 1], then push .

10:00 am	FWD	Setup
Custom Monitor 1		
Custom Monitor 2		
Custom Monitor 3		
Custom Monitor 4		
Custom Monitor 5		
Custom Monitor 6		
Back	Home	

6. Push  or  to select the monitor number to register, then push .

Set the x-xx part of monitor *Ux-xx*. For example, to show monitor *U1-05*, set it to “105” as shown in this figure.

10:00 am	FWD	Parameters
Custom Monitor 1		
01-24	105	
Frequency Reference		
Default : 101		
Back	Default	



The configuration procedure is complete.

◆ Show Custom Monitors

The procedure in this section shows how to show the registered custom monitors.

1. Push  (Home) to show the HOME screen.

Note:



- The keypad will show [Home] in the top right corner when the HOME screen is active.
- If [Home] is not shown on , push  (Back) to show [Home] on .

2. Push  (Menu).

10:00 am	FWD	Rdy	Home
Freq Reference (AI)			
U1-01	Hz	0.00	
Output Frequency			
U1-02	Hz	0.00	
Output Current			
U1-03	A	0.00	
Menu			

3. Push  or  to select [Monitors], then push .



10:00 am	FWD	Rdy	Menu
Monitors			
Parameters			
User Custom Parameters			
Parameter Backup/Restore			
Modified Param / Fault Log			
Auto-Tuning			
Home			

4. Push  or  to select [Custom Monitor], then push .

10:00 am	FWD	Rdy	Monitor
Standard Monitor			
Custom Monitor			
Bar Graph			
Analog Gauge			
Trend Plot			
Back	Home	Setup	

The keypad shows the selected monitor as shown in this figure.

10:00 am	FWD	Rdy	Monitor
Motor Speed			20.00
U1-05	Hz		
Output Power			15.0
U1-08	kw		
Terminal A1 Level			30.0
U1-13	%		
Home			



- When there are a minimum of two screens, push  or  to switch between screens.
- If you registered only one custom monitor to [Custom Monitor 1], the screen will show only one monitor. If you registered custom monitors only to [Custom Monitor 1] and [Custom Monitor 2], the screen will show only two monitors.

◆ Set the Monitors to Show as a Bar Graph

The procedure in this section shows how to show the frequency reference monitor as a bar graph.

1. Push  (Home) to show the HOME screen.







Note:

- The keypad will show [Home] in the top right corner when the HOME screen is active.
- If [Home] is not shown on , push  (Back) to show [Home] on .

2. Push  (Menu).

10:00 am	FWD	Rdy	Home
Freq Reference (AI)			0.00
U1-01	Hz		
Output Frequency			0.00
U1-02	Hz		
Output Current			0.00
U1-03	A		
Menu			

3. Push  or  to select [Monitors], then push .

10:00 am	FWD	Rdy	Menu
 Monitors			
 Parameters			
 User Custom Parameters			
 Parameter Backup/Restore			
 Modified Param / Fault Log			
 Auto-Tuning			
Home			

4. Push  or  to select [Bar Graph], then push  (Setup).

10:00 am	FWD	Rdy	Monitor
Standard Monitor			
Custom Monitor			
Bar Graph			
Analog Gauge			
Trend Plot			
Back	Home	Setup	

5. Push  or  to select the location to store the monitor, then push .

10:00 am	FWD	Setup	
Custom Monitor 1			
Custom Monitor 2			
Custom Monitor 3			
Back	Home		

6. Push .

10:00 am FWD	Setup
Custom Monitor 1	
o1-24	101 (101)
1st Monitor Area Selection	
o1-41	0 (0)
Back	Home

7. Push  or  to select the monitor number to register, then push .

Enter the three digits in “x-xx” part of monitor *Ux-xx* to identify which monitor to output. For example, to show monitor *U1-01* [*Frequency Reference*], set it to “101” as shown in this figure.

10:00 am FWD	Parameters
Custom Monitor 1	
o1-24	101
Frequency Reference	
Default : 101	
Back	Default



The configuration procedure is complete.

◆ Show Monitors as Bar Graphs

The procedure in this section shows how to show a specific monitor as a bar graph. You can show a maximum of three.

1. Push  (Home) to show the HOME screen.







Note:



- When the drive is in HOME Mode, the screen shows [Home] in the upper right-hand corner of the screen.
- If the screen does not show [Home] for , push  (Back), and then push  to show [Home].

2. Push  (Menu).

10:00 am FWD Rdy	Home
Freq Reference (AI)	
U1-01 Hz	0.00
Output Frequency	
U1-02 Hz	0.00
Output Current	
U1-03 A	0.00
Menu	

3. Push  or  to select [Monitors], then push .

10:00 am FWD Rdy	Menu
 Monitors	
 Parameters	
 User Custom Parameters	
 Parameter Backup/Restore	
 Modified Param / Fault Log	
 Auto-Tuning	
Home	

4. Push  or  to select [Display Bar Graph], then push .

10:00 am FWD Rdy	Monitor
Standard Monitor	
Custom Monitor	
Bar Graph	
Analog Gauge	
Trend Plot	
Back	Home Setup

The screen will show the monitors as shown in this figure.

10:00 am	FWD	Rdy	Monitor
U1-01	██████████	██████████	██████████
40.00Hz	-100%	0%	100%
U1-02	██████████	██████████	██████████
40.00Hz	-100%	0%	100%
U1-03	██████████	██████████	██████████
3.0A	-100%	0%	100%
Home			

◆ Set the Monitors to Show as Analog Gauges

The procedure in this section shows how to show the frequency reference monitor as an analog gauge.

1. Push **F2** (Home) to show the HOME screen.

Note:

- The keypad will show [Home] in the top right corner when the HOME screen is active.
- If [Home] is not shown on **F2**, push **F1** (Back) to show [Home] on **F2**.

2. Push **F2** (Menu).

10:00 am	FWD	Rdy	Home
Freq Reference (AI)			
U1-01 Hz	-----		0.00
Output Frequency			
U1-02 Hz	-----		0.00
Output Current			
U1-03 A	-----		0.00
Menu			

3. Push **▲** or **▼** to select [Monitors], then push **↵**.

10:00 am	FWD	Rdy	Menu
Monitors			
Parameters			
User Custom Parameters			
Parameter Backup/Restore			
Modified Param / Fault Log			
Auto-Tuning			
Home			

4. Push **▲** or **▼** to select [Analog Gauge], then push **F3** (Setup).

10:00 am	FWD	Rdy	Monitor
Standard Monitor			
Custom Monitor			
Bar Graph			
Analog Gauge			
Trend Plot			
Back		Home Setup	

5. Push **↵**.

10:00 am	FWD	Setup
Analog Gauge		
Custom Monitor 1		
o1-24	101	(101)
Analog Gauge Area Selection		
o1-55	1	(1)
Back		Home

6. Push **▲** or **▼** to select the monitor number to register, then push **↵**.

Enter the three digits in "x-xx" part of monitor U_x-xx to identify which monitor to output. For example, to show monitor U1-01 [Frequency Reference], set it to "101" as shown in this figure.

10:00 am FWD	Parameters
Custom Monitor 1	
01-24	101
Frequency Reference	
Default : 101	
Back	Default

The configuration procedure is complete.

◆ Display Monitors as an Analog Gauge

The following explains how to display the contents selected for a monitor as an analog gauge.

1. Push **F2** (Home) to show the HOME screen.

Note:

- The keypad will show [Home] in the top right corner when the HOME screen is active.
- If [Home] is not on **F2**, push **F1** (Back) to show [Home] on **F2**.

2. Push **F2** (Menu).

10:00 am FWD Rdy	Home
Freq Reference (AI)	
U1-01 Hz	0.00
Output Frequency	
U1-02 Hz	0.00
Output Current	
U1-03 A	0.00
Menu	

3. Push **▲** or **▼** to select [Monitors], then push **↵**.

10:00 am FWD Rdy	Menu
Monitors	
Parameters	
User Custom Parameters	
Parameter Backup/Restore	
Modified Param / Fault Log	
Auto-Tuning	
Home	

4. Push **▲** or **▼** to select [Analog Gauge], then push **↵**.

10:00 am FWD Rdy	Monitor
Standard Monitor	
Custom Monitor	
Bar Graph	
Analog Gauge	
Trend Plot	
Back	Home Setup

It will be displayed as follows.

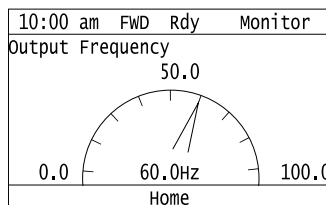

◆ Set Monitoring Items to be Shown as a Trend Plot

You must set the items in this figure to display as a trend plot.

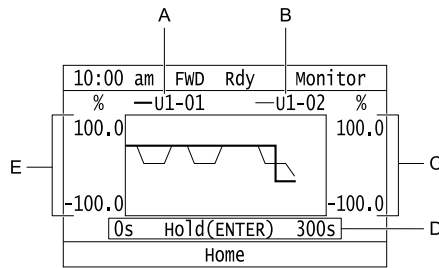

A - Monitor Parameter 1 (set with [Custom Monitor 1])

B - Monitor Parameter 2 (set with [Custom Monitor 2])

C - Trend Plot 2 Scale Maximum/Minimum Value

D - Trend Plot Time Scale

E - Trend Plot 1 Scale Maximum/Minimum Value

■ Select Monitor Items to Show as a Trend Plot

The procedure in this section shows how to show the frequency reference monitor as a trend plot.

1. Push **F2** (Home) to show the HOME screen.

Note:

- The keypad will show [Home] in the top right corner when the HOME screen is active.
- If [Home] is not shown on **F2**, push **F1** (Back) to show [Home] on **F2**.

2. Push **F2** (Menu).

10:00 am	FWD	Rdy	Home
Freq Reference (AI)			
U1-01	Hz		0.00
Output Frequency			
U1-02	Hz		0.00
Output Current			
U1-03	A		0.00
Menu			

3. Push **▲** or **▼** to select [Monitors], then push **↩**.

10:00 am	FWD	Rdy	Menu
Monitors ▶			
Parameters			
User Custom Parameters			
Parameter Backup/Restore			
Modified Param / Fault Log			
Auto-Tuning			
Home			

4. Push **▲** or **▼** to select [Trend Plot], then push **F3** (Setup).

10:00 am	FWD	Rdy	Monitor
Standard Monitor			
Custom Monitor			
Bar Graph			
Analog Gauge			
Trend Plot ▶			
Back Home Setup			

5. Push **▲** or **▼** to select [Custom Monitor 1], then push **↩**.

10:00 am	FWD		Setup
Custom Monitor 1 ▶			
Custom Monitor 2			
Trend Plot Time Scale Setting			
Back Home			

6. Push .

10:00 am FWD	Setup
Custom Monitor 1	
o1-24	101 (101)
Trend Plot 1 Scale Minimum Value	
o1-47	-100.0 (-100.0)%
Back	Home





7. Push  or  to select the monitor number to register, then push .

When the *U* parameters are on the display as "Ux-xx", the three digits in "x-xx" identify which monitor to output. For example, to show monitor *U1-01 [Frequency Reference]*, set it to "101" as shown in this figure.



10:00 am FWD	Parameters
Custom Monitor 1	
o1-24	101
Frequency Reference	
Default : 101	
Back	Default

8. Push  or  to select [Trend Plot 1 Scale Minimum Value], then push .

10:00 am FWD	Setup
Custom Monitor 1	
Trend Plot 1 Scale Minimum Value	
o1-47	-100.0 (-100.0)%
Trend Plot 1 Scale Maximum Value	
o1-48	100.0 (100.0)%
Back	Home



9. Push  or  to select the specified digit, then push  or  to select the correct number.

10:00 am FWD	Parameters
Trend Plot 1 Scale Minimum Value	
o1-47	1 00.0 %
Default : -100.0%	
Range : -300.0~ 99.9	
Back	Default Min/Max

- Push  (Default) to set the parameters to the factory default.
- Push  (Min/Max) to move between the minimum value and maximum value.

10. Push  to keep the changes.

10:00 am FWD	Parameters
Trend Plot 1 Scale Minimum Value	
o1-47	00 2 0.0 %
Default : -100.0%	
Range : -300.0~ 99.9	
Back	Default Min/Max

11. Push  or  to select [Trend Plot 1 Scale Maximum Value], then push .

10:00 am FWD	Setup
Custom Monitor 1	
Trend Plot 1 Scale Minimum Value	
o1-47	100.0 (-100.0)%
Trend Plot 1 Scale Maximum Value	
o1-48	100.0 (100.0)%
Back	Home

12. Push or to select the specified digit, then push or to select the correct number.

10:00 am	FWD	Parameters
Trend Plot 1 Scale Maximum Value		
01-48	0	100.0 %
Default : 100.0%		
Range : 20.1~ 300.0		
Back	Default	Min/Max

- Push (Default) to set the parameters to the factory default.
- Push (Min/Max) to move between the minimum value and maximum value.

13. Push to keep the changes.

10:00 am	FWD	Parameters
Trend Plot 1 Scale Maximum Value		
01-48	00	80.0 %
Default : 100.0%		
Range : 20.1~ 300.0		
Back	Default	Min/Max

14. Push (Back).

If necessary, use the same procedure to set [Custom Monitor 2].

■ Set the Time Scale for the Trend Plot Monitor

The procedure in this section shows how to set the time scale for the trend plot monitor.

1. Push (Home) to show the HOME screen.

Note:

- The keypad will show [Home] in the top right corner when the HOME screen is active.
- If [Home] is not shown on , push (Back) to show [Home] on .

2. Push (Menu).

10:00 am	FWD	Rdy	Home
Freq Reference (AI)			
U1-01	Hz		0.00
Output Frequency			
U1-02	Hz		0.00
Output Current			
U1-03	A		0.00
Menu			

3. Push or to select [Monitors], then push .

10:00 am	FWD	Rdy	Menu
Monitors			
Parameters			
User Custom Parameters			
Parameter Backup/Restore			
Modified Param / Fault Log			
Auto-Tuning			
Home			

4. Push or to select [Trend Plot], then push (Setup).

10:00 am	FWD	Rdy	Monitor
Standard Monitor			
Custom Monitor			
Bar Graph			
Analog Gauge			
Trend Plot			
Back Home Setup			

5. Push or to select [Trend Plot Time Scale Setting], then push .

10:00 am	FWD	Setup
1st Monitor Setting		
2nd Monitor Setting		
Trend Plot Time Scale Setting ▶		
Back	Home	

6. Push or to select the specified digit, then push or to select the correct number.

10:00 am	FWD	Parameters
Trend Plot Time Scale Setting		
01-51	0	300 sec
Default : 300sec		
Range : 1~3600		
Back	Default	Min/Max

- Push (Default) to set the parameters to the factory default.
- Push (Min/Max) to move between the minimum value and maximum value.

7. Push to keep the changes.

10:00 am	FWD	Parameters
Trend Plot Time Scale Setting		
01-51	1	300 sec
Default : 300sec		
Range : 1~3600		
Back	Default	Min/Max

The configuration procedure is complete.

◆ Show Monitor Items as a Trend Plot

The procedure in this section shows how to show the selected monitor data as a trend plot.

1. Push (Home) to show the HOME screen.

Note:

- The keypad will show [Home] in the top right corner when the HOME screen is active.
- If [Home] is not shown on , push (Back) to show [Home] on .

2. Push (Menu).

10:00 am	FWD	Rdy	Home
Freq Reference (AI)			
U1-01	Hz	0.00	
Output Frequency			
U1-02	Hz	0.00	
Output Current			
U1-03	A	0.00	
Menu			

3. Push or to select [Monitors], then push .

10:00 am	FWD	Rdy	Menu
Monitors ▶			
Parameters			
User Custom Parameters			
Parameter Backup/Restore			
Modified Param / Fault Log			
Auto-Tuning			
Home			

4. Push  or  to select [Trend Plot], then push .

10:00 am FWD Rdy Monitor
Standard Monitor
Custom Monitor
Bar Graph
Analog Gauge
Trend Plot
Back Home Setup

The screen will show the monitors as shown in this figure.

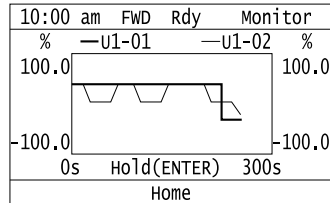

Note:



Push  (Hold) to switch between Pause and Restart for the monitor display. The “Hold (ENTER)” message flashes while monitoring is paused.

◆ Change Parameter Setting Values

This example shows how to change the setting value for *C1-01 [Acceleration Time 1]*. Do the steps in this procedure to set parameters for the application.

1. Push  (Home) to show the HOME screen.

Note:

- When the drive is in HOME Mode, the screen shows [Home] in the upper right-hand corner of the screen.
- If [Home] is not shown above the , push  (Back).

2. Push  (Menu).

10:00 am FWD Rdy Home
Freq Reference (AI)
U1-01 Hz 0.00
Output Frequency
U1-02 Hz 0.00
Output Current
U1-03 A 0.00
Menu

3. Push  or  to select [Parameters], then push .

10:00 am FWD Menu
Monitors
Parameters
User Custom Parameters
Parameter Backup/Restore
Modified Param / Fault Log
Auto-Tuning
Home

4. Push  or  to select [C Tuning], then push .

10:00 am FWD Parameters
A Initialization Parameters
b Application
C Tuning
d References
E Motor Parameters
F Options
Back Home

5. Push or to select [C1 Accel & Decel Time], then push .

10:00 am	FWD	Parameters
C1 Accel & Decel Time		
C2 S-Curve Characteristics		
C3 Slip Compensation		
C4 Torque Compensation		
C6 Duty & Carrier Frequency		
Back	Home	

6. Push or to select C1-01, then push .

10:00 am	FWD	Parameters
Acceleration Time 1		
C1-01	10.0	(10.0)sec
Deceleration Time 1		
C1-02	10.0	(10.0)sec
Acceleration Time 2		
C1-03	10.0	(10.0)sec
Back	Home	

7. Push or to select the specified digit, then push or to select the correct number.

10:00 am	FWD	Parameters
Acceleration Time 1		
C1-01	0010.0sec	
Default : 10.0sec		
Range : 0.0~6000.0		
Back	Default	Min/Max

- Push [Default] to set the parameter to factory default.
- Push [Min/Max] to show the minimum value or the maximum value on the display.

8. Push to keep the changes.

10:00 am	FWD	Parameters
Acceleration Time 1		
C1-01	0020.0 sec	
Default : 10.0 sec		
Range : 0.0~6000.0		
Back	Default	Min/Max

9. Continue to change parameters, then push [Back], [Home] to go back to the home screen after you change all the applicable parameters.

◆ Examine User Custom Parameters

The User Custom Parameters show the parameters set in A2-01 to A2-32 [User Parameter 1 to User Parameter 32]. This lets users to quickly access and change settings to these parameters.

Note:

The User Custom Parameters always show A1-06 [Application Selection] at the top of the list. The A2-01 to A2-32 settings change when the A1-06 setting changes, which makes it easier to set and reference the necessary parameter settings.

1. Push (Home) to show the HOME screen.







Note:



- The keypad will show [Home] in the top right corner when the HOME screen is active.
- If [Home] is not shown on , push (Back) to show [Home] on .

2. Push **F2** (Menu).

10:00 am	FWD	Rdy	Home
Freq Reference (AI)			
U1-01	Hz		0.00
Output Frequency			
U1-02	Hz		0.00
Output Current			
U1-03	A		0.00
Menu			

3. Push  or  to select [User Custom Parameters], then push .





10:00 am	FWD	Menu
 Monitors		
 Parameters		
 User Custom Parameters		
 Parameter Backup/Restore		
 Modified Param / Fault Log		
 Auto-Tuning		
Home		

4. Push  or  to show the parameter to examine.

10:00 am	FWD	Parameters
Application Preset		
A1-06	0	(0)
Control Method Selection		
A1-02	2	(2)
Frequency Reference Selection 1		
b1-01	1	(1)
Back	Home	

5. To change the parameter settings, push  or  to select the parameter, then push .

10:00 am	FWD	Parameters
Application Preset		
A1-06	0	(0)
Control Method Selection		
A1-02	2	(2)
Frequency Reference Selection 1		
b1-01	1	(1)
Back	Home	

6. Push  or  to select the digit, then push  or  to change the value.

10:00 am	FWD	Parameters
Control Method Selection		
A1-02	2	
Open Loop Vector Control		
Default : 2		
Back	Default	

7. Change the value, push .

10:00 am	FWD	Parameters
Control Method Selection		
A1-02	0	
V/f Control		
Default : 2		
Back	Default	

The parameter setting procedure is complete.

◆ Save a Backup of Parameters

You can save a backup of the drive parameters to the keypad. The keypad can store parameter setting values for a maximum of four drives in different storage areas. Parameter setting backups can save time when you set parameters after you replace a drive. If you set up more than one drive, you can copy the parameter settings from a drive that completed a test run to the other drives.

Note:

- Stop the motor before you back up parameters.
- While you back up parameters, the drive will not accept Run commands.
- The DriveWorksEZ PC software password is necessary to back up *qx-xx* [DriveWorksEZ Parameters] and *rx-xx* [DWEZ Connection Parameters]. If you enter an incorrect password, the drive detects *PWEr* [DWEZ Password Mismatch].

1. Push **F2** (Home) to show the HOME screen.

Note:



- When the drive is in HOME Mode, the screen shows [Home] in the upper right-hand corner of the screen.
- If the screen does not show [Home] for **F2**, push **F1** (Back), and then push **F2** to show [Home].

2. Push **F2** (Menu).



10:00 am FWD Rdy	Home
Freq Reference (AT)	0.00
U1-01 Hz	-----
Output Frequency	0.00
U1-02 Hz	-----
Output Current	0.00
U1-03 A	-----
Menu	

3. Push  or  to select [Parameter Backup/Restore], then push .



10:00 am FWD	Menu
Monitors	
Parameters	
User Custom Parameters	
Parameter Backup/Restore	▶
Modified Param / Fault Log	
Auto-Tuning	
Home	

4. Push  or  to select the items to back up, then push .

10:00 am FWD	Backup
Select Items to Backup/Restore	
Standard Parameters	▶
Back	Home

5. Push  or  to select [Backup (drive → keypad)], then push .

10:00 am FWD	Backup
Select Desired Action	
Backup (drive → keypad)	▶
Restore (keypad → drive)	
Verify (check for mismatch)	
Erase (backup data of keypad)	
Back	Home

6. Push  or  to select a memory location, then push .

10:00 am	FWD	Backup
Select Backup/Restore Location		
#1	No Data	▶
#2	No Data	
#3	No Data	
#4	No Data	
Back		Home

The keypad shows “End” when the backup procedure completes successfully.

◆ Write Backed-up Parameters to the Drive



You can back up parameters on the keypad and write them to different drives.

Note:

- Always stop the drive before you start to restore the parameter backups.
- While you verify parameters, the drive will not accept Run commands.

1. Push  (Home) to show the HOME screen.

Note:



- When the drive is in HOME Mode, the screen shows [Home] in the upper right-hand corner of the screen.
- If the screen does not show [Home] for , push  (Back), and then push  to show [Home].

2. Push  (Menu).

10:00 am	FWD	Rdy	Home
Freq Reference (AI)			
U1-01	Hz	-----	0.00
Output Frequency			
U1-02	Hz	-----	0.00
Output Current			
U1-03	A	-----	0.00
Menu			

3. Push  or  to select [Parameter Backup/Restore], then push .

10:00 am	FWD	Menu
Monitors		
Parameters		
User Custom Parameters		
Parameter Backup/Restore		▶
Modified Param / Fault Log		
Auto-Tuning		
Home		

4. Push  or  to select the item to restore, then push .

10:00 am	FWD	Backup
Select Items to Backup/Restore		
Standard Parameters ▶		
Back		Home

5. Push  or  to select [Restore (keypad → drive)], then push .

10:00 am	FWD	Backup
Select Desired Action		
Backup (drive → keypad)		
Restore (keypad → drive) ▶		
Verify (check for mismatch)		
Erase (backup data of keypad)		
Back		Home

6. Push  or  to select the backed-up parameter data, then push .

10:00 am	FWD	Backup
Select Backup/Restore Location		
#1	2016/01/01 13:00	0-62
#2	No Data	
#3	No Data	
#4	No Data	
Back		Home

The keypad will show the “End” message when the write process is complete.

Note:

The keypad display changes when the settings and conditions change.

		A	B	C
	10:00 am	FWD	Backup	
	Select Backup/Restore Location			
F	#1	2016/01/01 14:10	0-62	
	#2	2016/01/01 02:10pm	1-62	*
E	#3	---/--/-- --:--	2-62	*
D	#4	No Data		
Back		Home		

- A - A1-02 [Control Method Selection] settings
- B - o2-04 [Drive Model (KVA) Selection] settings (2 or 3 digits)
- C - Presence of DriveWorksEZ parameter backup
- D - Parameter backup data is not registered
- E - Backup data does not contain the date information
- F - Backup date

◆ Verify Keypad Parameters and Drive Parameters



This procedure makes sure that the parameter setting values that you backed up in the keypad agree with the parameter setting values in the drive.

Note:

- Always stop the drive before you start to verify the parameters.
- While you restore parameters, the drive will not accept Run commands.

1. Push  (Home) to show the HOME screen.







Note:



- When the drive is in HOME Mode, the screen shows [Home] in the upper right-hand corner of the screen.
- If the screen does not show [Home] for , push  (Back), and then push  to show [Home].

2. Push  (Menu).

10:00 am	FWD	Rdy	Home
Freq Reference (AI)			
U1-01	Hz		0.00
Output Frequency			
U1-02	Hz		0.00
Output Current			
U1-03	A		0.00
Menu			

3. Push  or  to select [Parameter Backup/Restore], then push .



10:00 am	FWD	Menu
	Monitors	
	Parameters	
	User Custom Parameters	
	Parameter Backup/Restore	
	Modified Param / Fault Log	
	Auto-Tuning	
Home		

4. Push  or  to select the item to verify, then push .

10:00 am	FWD	Backup
Select Items to Backup/Restore		
Standard Parameters ▶		
Back	Home	

5. Push  or  to select [Verify (drive → keypad)], then push .

10:00 am	FWD	Backup
Select desired action.		
Backup (drive → keypad)		
Restore (keypad → drive)		
Verify (check for mismatch) ▶		
Erase (backup data of keypad)		
Back	Home	

6. Push  or  to select the data to verify, then push .

10:00 am	FWD	Backup
Select Backup/Restore Location		
#1 2016/01/01 13:00 0-62 ▶		
#2 No Data		
#3 No Data		
#4 No Data		
Back	Home	

The keypad shows “End” when the parameter settings backed up in the keypad agree with the parameter settings copied to the drive.

Note:



The keypad shows $vFyE$ [*Parameters do not Match*] when the parameter settings backed up in the keypad do not agree with the parameter settings copied to the drive. Push one of the keys to return to the screen in Step 6.

◆ Delete Parameters Backed Up to the Keypad

This procedure deletes the parameters that you backed up to the keypad.

1. Push  (Home) to show the HOME screen.







Note:



- When the drive is in HOME Mode, the screen shows [Home] in the upper right-hand corner of the screen.
- If the screen does not show [Home] for , push  (Back), and then push  to show [Home].

2. Push  (Menu).



10:00 am	FWD	Rdy	Home
Freq Reference (AI)			
U1-01	Hz		0.00
Output Frequency			
U1-02	Hz		0.00
Output Current			
U1-03	A		0.00
Menu			

3. Push  or  to select [Parameter Backup/Restore], then push .

10:00 am FWD	Menu
 Monitors	
 Parameters	
 User Custom Parameters	
 Parameter Backup/Restore	
 Modified Param / Fault Log	
 Auto-Tuning	
Home	



4. Push  or  to select the item to delete, then push .

10:00 am FWD	Backup
Select Items to Backup/Restore	
Standard Parameters	
Back Home	

5. Push  or  to select [Erase (backup data of keypad)], then push .

10:00 am FWD	Backup
Select desired action.	

Backup (drive → keypad)	
Restore (keypad → drive)	
Verify (check for mismatch)	
Erase (backup data of keypad)	
Back Home	

6. Push  or  to select the data to delete, then push .

10:00 am FWD	Backup
Select Backup/Restore Location	
#1 2016/01/01 14:10 0-62	
#2 2016/01/01 02:10pm 1-62	
#3 ----/--/-- --:-- 2-62	
#4 No Data	
Back Home	



The keypad will show the “End” message when the write process is complete.

◆ Check Modified Parameters

This procedure will show all parameters that are not at their default values. You can also use this procedure to quickly access and edit changed parameters and is very useful when you replace a drive. When all parameters are at their default values, the keypad will show “0 Parameters”.

1. Push  (Home) to show the HOME screen.

Note:

- The keypad will show [Home] in the top right corner when the HOME screen is active.
- If [Home] is not shown on , push  (Back) to show [Home] on .







2. Push  (Menu).

10:00 am FWD Rdy	Home
Freq Reference (AI)	
U1-01 Hz	0.00



Output Frequency	
U1-02 Hz	0.00

Output Current	
U1-03 A	0.00
Menu	

3. Push  or  to select [Modified Param / Fault Log], then push .



10:00 am	FWD	Menu
	Monitors	
	Parameters	
	User Custom Parameters	
	Parameter Backup/Restore	
	Modified Param / Fault Log	
	Auto-Tuning	
Home		

4. Push  or  to select [Modified Parameters], then push .

10:00 am	FWD	History
	Modified Parameters	
	Fault Log	
Back Home		

5. Push .





10:00 am	FWD	Modified
User Modified Parameters		
Standard Parameters		
2 Parameters		
Back Home		

6. Push  or  to show the parameter to check.

10:00 am	FWD	Modified
Acceleration Time 1		
C1-01	20.0	(10.0)sec
Motor Rated Current (FLA)		
E2-01	97.2	(77.2)A
Back Home		

7. To re-edit a parameter, push  or , select the parameter to edit, then push .

10:00 am	FWD	Modified
Acceleration Time 1		
C1-01	20.0	(10.0)sec
Motor Rated Current (FLA)		
E2-01	97.2	(77.2)A
Back Home		

8. Push  or  to select the digit, then push  or  to change the value.

10:00 am	FWD	Parameters
Acceleration Time 1		
C1-01	00	20.0 sec
Default : 10.0sec		
Range : 0.0~6000.0		
Back	Default	Min/Max

9. When you are done changing the value, push .

10:00 am	FWD	Parameters
Acceleration Time 1		
C1-01	0030.0	sec
Default : 10.0sec		
Range : 0.0~6000.0		
Back	Default	Min/Max



The parameter revision procedure is complete.

◆ Restore Modified Parameters to Defaults

This procedure will set all parameters with changed values to their default settings.

1. Push  (Home) to show the HOME screen.







Note:

- The keypad will show [Home] in the top right corner when the HOME screen is active.
- If [Home] is not shown on , push  (Back) to show [Home] on .



2. Push  (Menu).

10:00 am	FWD	Rdy	Home
Freq Reference (AI)			
U1-01	Hz		0.00
Output Frequency			
U1-02	Hz		0.00
Output Current			
U1-03	A		0.00
Menu			

3. Push  or  to select [Modified Param / Fault Log], then push .



10:00 am	FWD	Menu
 Monitors  Parameters  User Custom Parameters  Parameter Backup/Restore  Modified Param / Fault Log ▶  Auto-Tuning		
Home		

4. Push  or  to select [Modified Parameters], then push .

10:00 am	FWD	History
 Modified Parameters ▶  Fault Log		
Back	Home	

5. Push .

10:00 am	FWD	Modified
User Modified Parameters		
Standard Parameters ▶		
2 Parameters		
Back	Home	

6. Push  or  to select the parameters to return to their default settings, then push .

10:00 am	FWD	Modified
Acceleration Time 1		
C1-01	20.0	(10.0)sec
Motor Rated Current (FLA)		
E2-01	97.2	(77.2)A
Back	Home	

7. Push  (Default).

10:00 am	FWD	Parameters
Acceleration Time 1		
C1-01	0020.0	sec
Default : 10.0sec		
Range : 0.0~6000.0		
Back	Default	Min/Max

8. Push .

10:00 am	FWD	Parameters
Acceleration Time 1		
C1-01	0010.0	sec
Default : 10.0sec		
Range : 0.0~6000.0		
Back	Default	Min/Max

The modified parameters are now set to default values.

◆ Show Fault History



You can examine a maximum of 10 fault codes and dates and times that the faults occurred.

Note:

- Make sure that you first set the date and time on the keypad if you will monitor the date and time of the faults.
- If the keypad does not have a clock battery, you must set the date and time each time you energize the drive.

1. Push  (Home) to show the HOME screen.

Note:



- The keypad will show [Home] in the top right corner when the HOME screen is active.
- If [Home] is not shown on , push  (Back) to show [Home] on .

2. Push  (Menu).



10:00 am	FWD	Rdy	Home
Freq Reference (AI)			
U1-01	Hz		0.00
Output Frequency			
U1-02	Hz		0.00
Output Current			
U1-03	A		0.00
Menu			

3. Push  or  to select [Modified Parameters/Fault History], then push .

10:00 am	FWD	Menu
Monitors		
Parameters		
User Custom Parameters		
Parameter Backup/Restore		
Modified Param / Fault Log		
Auto-Tuning		
Home		

4. Push  or  to select [Fault History], then push .

10:00 am FWD	History
Modified Parameters	
▲ Fault Log	
Back	Home

5. Push  or  to show the fault history you will examine.

10:00 am FWD	History
Fault History Log	
01 ov	2016/01/01 14:00 Overvoltage
02 oc	2016/01/01 14:00 Overcurrent
Back	Home

◆ Auto-Tuning the Drive

Auto-Tuning uses motor characteristics to automatically set drive parameters.

Refer to the motor nameplate or the motor test report for the necessary information for Auto-Tuning.

VARTSPEED									
3-PHASE PERMANENT MAGNET MOTOR									
TYPE SST4-					POLES E5-04				
PROTECTION					COOLING				
kW	V	Hz	RATING	A	r/min	r _i	E5-05		
E5-02	E1-05			E5-03	E1-04, 06	Ld	E5-06		
						Lq	E5-07		
						Ke	E5-09		
INS.	COOLANT TEMP.	°C	ALTITUDE	m	Δθ	E5-11			
STD			MASS	kg	Δθ'				
BRG NO	DRIVE		OPP		Ki				
SER NO	END		YEAR		Kt				
YASKAWA ELECTRIC CORPORATION JAPAN									
						Si			

Figure 4.12 Motor Nameplate (Example)

WARNING! Sudden Movement Hazard. Before you do Auto-Tuning, remove all personnel and objects from the area around the drive, motor, and load. The drive and motor can start suddenly during Auto-Tuning and cause serious injury or death.



WARNING! Electrical Shock Hazard. During Auto-Tuning, the motor will receive high voltage when the motor is stopped. Do not touch the motor until Auto-Tuning is complete. If you touch a motor that is energized, it can cause serious injury or death.

WARNING! Sudden Movement Hazard.. Before you do Rotational Auto-Tuning, disconnect the load from the motor. The load can move suddenly and cause serious injury or death.

This procedure shows how to do Rotational Auto-Tuning.



1. Push  (Home) to show the HOME screen.







Note:

- When the drive is in HOME Mode, the screen shows [Home] in the upper right-hand corner of the screen.
- If the screen does not show [Home] for , push  (Back), and then push  to show [Home].

2. Push  (Menu).



10:00 am FWD Rdy	Home
Freq Reference (AI)	
U1-01 Hz	0.00
Output Frequency	
U1-02 Hz	0.00
Output Current	
U1-03 A	0.00
Menu	

3. Push  or  to select [Auto-Tuning], then push .

10:00 am	FWD	Menu
	Parameters	
	User Custom Parameters	
	Parameter Backup/Restore	
	Modified Param / Fault Log	
	Auto-Tuning	
	Initial Setup	
	Home	





4. Push .

10:00 am	FWD	Auto Tuning
Select Auto-Tuning mode		
Motor Parameter Tuning 		
Back Home		

5. Push  or  to select [Rotational Auto-Tuning], then push .

10:00 am	FWD	Auto Tuning
Select Auto-Tuning method		
Rotational Auto-Tuning 		
Stationary Auto-Tuning		
Stationary Line-Line Resistance		
Back Home		

6. Follow the messages shown on the keypad to input the necessary Auto-Tuning data.

Example: Push  or  to select the specified digit, then push  or  to change the number. Push  to save the change and move to the next entry field.

10:00 am	FWD	Auto Tuning
Enter motor rated power in kw		
----- 007.50 kw		
Range : 0.00~650.00		
Back Home		



7. Follow the messages shown on the keypad to do the next steps.

8. When the keypad shows the Auto-Tuning start screen, push .

10:00 am	FWD	Auto Tuning
RUN key : Tuning Start		
Home key : Cancel		
The motor turns. Please be careful.		
Back Home		



Auto-Tuning starts.

When doing Rotational Auto-Tuning, the motor will stay stopped for approximately one minute with power energized and then the motor will start to rotate.

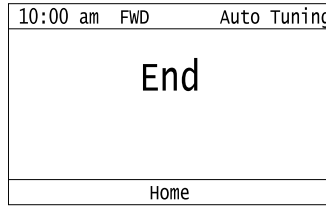

9. When the keypad shows this screen after Auto-Tuning is complete for 1 or 2 minutes, push  or .

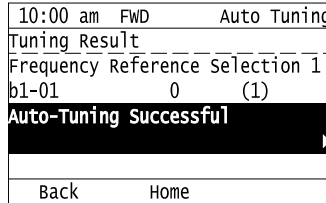

The keypad will show a list of the changed parameters as the result of Auto-Tuning.

10. Push  or  in the parameter change confirmation screen to check the changed parameters, then select [Auto-Tuning Successful] at the bottom of the screen and push .



To change a parameter again, push  or  to select the parameter to change, then push  to show the parameter setting screen.

Auto-Tuning is complete.

Note:

If the drive detects an error or you push  before Auto-Tuning is complete, Auto-Tuning will stop and the keypad will show an error code. *Endx* identifies that Auto-Tuning was successful with calculation errors. Find and repair the cause of the error and do Auto-Tuning again, or set the motor parameters manually. You can use the drive in the application if you cannot find the cause of the *Endx* error. *Er-xx* identifies that Auto-Tuning was not successful. Find and repair the cause of the error and do Auto-Tuning again.

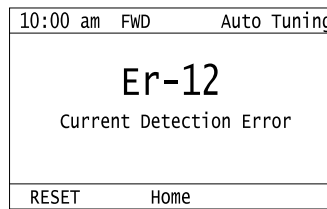
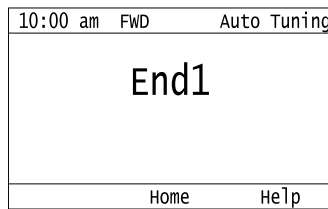



◆ Set the Keypad Language Display

The procedure in this section shows how to set the language shown on the keypad.



1. Push  (Home) to show the HOME screen.





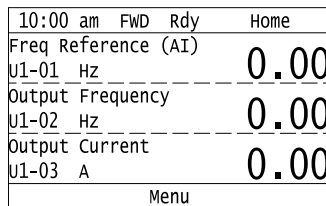

Note:

- The keypad will show [Home] in the top right corner when the HOME screen is active.
- If [Home] is not shown on , push  (Back), to show [Home] on .





2. Push  (Menu).





3. Push  or  to select [Initial Settings], then push .

10:00 am	FWD	Menu
	User Custom Parameters	
	Parameter Backup/Restore	
	Modified Param / Fault Log	
	Auto-Tuning	
	Initial Setup	
	Diagnostic Tools	
	Home	

4. Push  or  to select [Language Selection], then push .

10:00 am	FWD	Init Setup
	Language Selection	
	Set Date/Time	
	Setup Wizard	
	Show Initial Setup Screen	
	Back	Home

5. Push  or  to select the language, then push .

10:00 am	FWD	Init Setup
	Language Selection	
	English	
	Japanese	
	Deutsch	
	Frangais	
	Italiano	
	Back	Home

The procedure to set the keypad language is complete.

◆ Set the Date and Time



The procedure in this section shows how to set the date and time.

Note:

- Refer to [Replace the Keypad Battery on page 423](#) for information about the battery installation procedure.
- To set the drive to detect an alarm when the battery is dead or when the clock is not set, install the battery then set $o4-24 = 1$ [*bAT Detection selection = Enable (Alarm Detected)*].
- If the keypad does not have a clock battery, you must set the date and time each time you energize the drive.

1. Push  (Home) to show the HOME screen.

Note:



- The keypad will show [Home] in the top right corner when the HOME screen is active.
- If [Home] is not shown on , push  (Back) to show [Home] on .

2. Push  (Menu).

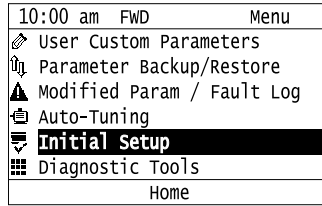

10:00 am	FWD	Rdy	Home
	Freq Reference (AI)		
	U1-01	Hz	0.00
	Output Frequency		
	U1-02	Hz	0.00
	Output Current		
	U1-03	A	0.00
			Menu

3. Push  or  to select [Initial Setup], then push .



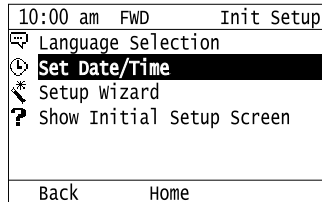

4. Push  or  to select [Set Date/Time], and push .

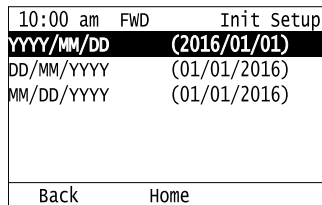

5. Push  or  to select the format of date display, then push .



6. Push  or  to select the format of time display, then push .

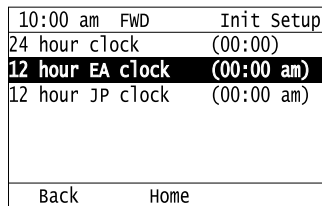



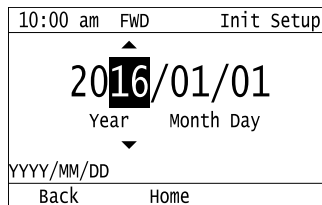

7. Push  or  to select a number from Year/Month/Day, then push  or  to change the value.

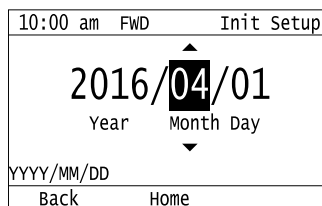

8. When you are done changing the value, push .



9. Push  or  to select the hour or minute, then push  or  to change the value.

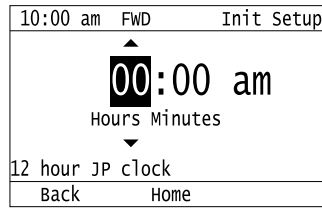

10. When you are done setting the time, push .

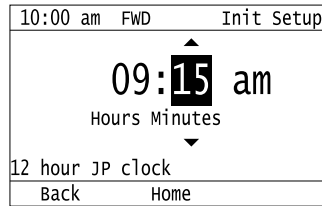

The procedure for setting the date and time is complete.

◆ Set Parameters Using the Setup Wizard

The Setup Wizard lets users follow simple messages on the keypad to set these basic parameters:



- Frequency reference source
- Input signal level
- Run command source
- Duty Rating
- Motor type
- Control method
- Maximum frequency
- Input/output settings

Note:

The Setup Wizard function will initialize all parameters before it sets the basic parameters.

1. Push  (Home) to show the HOME screen.







Note:



- The keypad will show [Home] in the top right corner when the HOME screen is active.
- If [Home] is not shown on , push  (Back) to show [Home] on .

2. Push  (Menu).



10:00 am FWD Rdy	Home
Freq Reference (AI)	
U1-01 Hz	0.00
Output Frequency	
U1-02 Hz	0.00
Output Current	
U1-03 A	0.00
Menu	

3. Push  or  to select [Initial Setup], then push .

10:00 am FWD	Menu
 User Custom Parameters	
 Parameter Backup/Restore	
 Modified Param / Fault Log	
 Auto-Tuning	
 Initial Setup	
 Diagnostic Tools	
Home	

4. Push  or  to select [Setup Wizard], then push .



10:00 am FWD	Init Setup
Language Selection	
Set Date/Time	
Setup Wizard	
Show Initial Setup Screen	
Back	Home

5. Push  or  to select [Yes], then push .

Note:

This operation will initialize all parameters.



10:00 am FWD	wizard
The setup wizard will reset all parameters to factory defaults. Continue?	
No	
Yes	
Back	Home

6. Push  or  to select the item to set, then push .

10:00 am FWD	wizard
Select speed reference source	
Keypad	
Analog Input	
Memobus/Modbus Communications	
Option PCB	
Back	Home



7. For the next steps, follow the instructions shown on the keypad until the “Parameter Change Confirmation Screen” is shown.



10:00 am FWD	wizard
Pending Parameter Changes	
Control Method Selection	
A1-02	0 (2)
Frequency Reference Selection 1	
b1-01	0 (1)
Back	Home

8. In the parameter change confirmation screen, push  or  to examine the changed parameter, then select [Apply of each parameter] at the bottom of the screen and push .

10:00 am FWD	wizard
Pending Parameter Changes	
Frequency Reference Selection 1	
b1-01	0 (1)
Apply Parameter Changes	
Back	Home

Note:

To change a parameter again, push  or  to select the parameter to change, then push  to show the parameter setting screen.

9. Push  or  to select [Yes], then push .

10:00 am	FWD	Wizard
Should the parameter settings be applied ?		
No		
Yes		
Back	Home	



The Setup Wizard procedure is complete.

◆ Disable the Initial Setup Screen

Do the steps in this procedure to not show the initial start-up screen when the drive is energized.



1. Push  (Home) to show the HOME screen.







Note:



- When the drive is in HOME Mode, the screen shows [Home] in the upper right-hand corner of the screen.
- If the screen does not show [Home] for , push  (Back), and then push  to show [Home].





2. Push  (Menu).



10:00 am	FWD	Rdy	Home
Freq Reference (AI)			
U1-01	Hz	0.00	
Output Frequency			
U1-02	Hz	0.00	
Output Current			
U1-03	A	0.00	
Menu			

3. Push  /  to select [Initial Setup], then push .

10:00 am	FWD	Menu
	User Custom Parameters	
	Parameter Backup/Restore	
	Modified Param / Fault Log	
	Auto-Tuning	
	Initial Setup	
	Diagnostic Tools	
Home		

4. Push  /  to select [Show Initial Setup Screen], then push .

10:00 am	FWD	Init Setup
	Language Selection	
	Set Date/Time	
	Setup Wizard	
	Show Initial Setup Screen	
Back		
Home		

5. Push  /  to select [No], then push .

10:00 am	FWD	Init Setup
Show Initial Setup Screen		
No		
Yes		
Back		
Home		

- [No]: The keypad will not show the Initial Setup Screen when the drive is energized.
- [Yes]: The keypad will show the Initial Setup Screen when the drive is energized.

◆ Start Data Logging

The data log function saves drive status information. Monitors *Ux-xx* are the source of log information. The procedure in this section shows how to start logging data.

You can record a maximum of 10 monitors.



1. Make sure that a microSD card is inserted in the keypad.
2. Push **F2** (Home) to show the HOME screen.

Note:

- When the drive is in HOME Mode, the screen shows [Home] in the upper right-hand corner of the screen.
- If the screen does not show [Home] for **F2**, push **F1** (Back), and then push **F2** to show [Home].

3. Push **F2** (Menu).

10:00 am FWD Rdy	Home
Freq Reference (AI)	
U1-01 Hz	0.00
Output Frequency	
U1-02 Hz	0.00
Output Current	
U1-03 A	0.00
Menu	

4. Push  or  to select [Diagnostic Tools], then push .

10:00 am FWD	Menu
User Custom Parameters	
Parameter Backup/Restore	
Modified Param / Fault Log	
Auto-Tuning	
Initial Setup	
Diagnostic Tools	
Home	

5. Push  or  to select [Data Logger], then push .

10:00 am FWD	Tools
Data Logger	
Backlight	
Drive Information	
Back	Home Setup

6. Push  or  to select [Yes] or [No], then push .

10:00 am FWD	Tools
Begin Data Logging?	
No	
Yes	
Back	Home

- [Yes]: Data logging starts.
- [No]: Data logging will not start.

If the drive was logging data when you entered the command, the keypad looks like this:

10:00 am FWD	Tools
End Data Logging?	
No	
Yes	
Start Time : 2016/01/01 00:00	
Period : 00:10:00	
Back	Home

◆ Configuring the Data Log Content

■ Set Monitor to Log

The procedure in this section shows how to set the monitor for which to log data.

1. Push **F2** (Home) to show the HOME screen.

Note:

- When the drive is in HOME Mode, the screen shows [Home] in the upper right-hand corner of the screen.
- If the screen does not show [Home] for **F2**, push **F1** (Back), and then push **F2** to show [Home].

2. Push **F2** (Menu).







10:00 am	FWD	Rdy	Home
Freq Reference (AI)			
U1-01	Hz		0.00

Output Frequency			
U1-02	Hz		0.00

Output Current			
U1-03	A		0.00

Menu			

3. Push  or  to select [Diagnostic Tools], then push .

10:00 am	FWD	Menu
	User Custom Parameters	
	Parameter Backup/Restore	
	Modified Param / Fault Log	
	Auto-Tuning	
	Initial Setup	
	Diagnostic Tools	

Home		

4. Push  or  to select [Data Logger], then push **F3** (Setup).

10:00 am	FWD	Tools
Data Logger		

Backlight		
Drive Information		

Back	Home	Setup

5. Push  or  to select [Log Monitor], then push .

10:00 am	FWD	Setup
Log Monitor		

Log Sampling Interval		

Back	Home	

6. Push  or  to select the save-destination monitor parameter, then push .

10:00 am	FWD	Setup
Log Monitor		

Log Monitor Data 1		
o5-03	101	(101)

Log Monitor Data 2		
o5-04	102	(102)

Back	Home	

7. Push  or  to select the monitor number to be logged, then push .

10:00 am FWD	Parameters
Log Monitor Data 1	
05-03	101
Freq Reference	
Default : 101	
Back	Default



The configuration procedure is complete.

■ Set the Sampling Time

The procedure in this section shows how to set the sampling time for data logging.

1. Push  (Home) to show the HOME screen.

Note:

- When the drive is in HOME Mode, the screen shows [Home] in the upper right-hand corner of the screen.
- If the screen does not show [Home] for , push  (Back), and then push  to show [Home].

2. Push  (Menu).

10:00 am FWD Rdy	Home
Freq Reference (AI)	
U1-01 Hz	0.00

Output Frequency	
U1-02 Hz	0.00

Output Current	
U1-03 A	0.00
Menu	

3. Push  or  to select [Diagnostic Tools], then push .

10:00 am FWD	Menu
User Custom Parameters	
Parameter Backup/Restore	
Modified Param / Fault Log	
Auto-Tuning	
Initial Setup	
Diagnostic Tools	
Home	

4. Push  or  to select [Data Logger], then push  (Setup).

10:00 am FWD	Tools
Data Logger	
Backlight	
Drive Information	
Back	Home Setup

5. Push  or  to select [Log Sampling Interval], then push .

10:00 am FWD	Setup
Log Monitor	
Log Sampling Interval	
Back	Home

6. Push or to select the digit, then push or to change the value.

10:00 am	FWD	Parameters
Log Sampling Interval		
05-02	0	1000 ms
Default : 1000ms		
Range : 100~60000		
Back	Default	Min/Max

7. When you complete changing the value, push .

10:00 am	FWD	Parameters
Log Sampling Interval		
05-02	2	0000 ms
Default : 1000ms		
Range : 100~60000		
Back	Default	Min/Max

The procedure to set the sampling time is complete.

◆ Set Backlight to Automatically Turn OFF

You can set the backlight of the keypad screen to automatically turn OFF after a set length of time since the last key operation on the keypad. The procedure in this section shows how to turn ON and turn OFF the backlight.

1. Push (Home) to show the HOME screen.

Note:

- The keypad will show [Home] in the top right corner when the HOME screen is active.
- If [Home] is not shown on , push (Back) to show [Home] on .

2. Push (Menu).



10:00 am	FWD	Rdy	Home
Freq Reference (AI)			
U1-01	Hz		0.00
Output Frequency			
U1-02	Hz		0.00
Output Current			
U1-03	A		0.00
Menu			

3. Push or to select [Diagnostic Tools], then push .

10:00 am	FWD	Menu
User Custom Parameters		
Parameter Backup/Restore		
Modified Param / Fault Log		
Auto-Tuning		
Initial Setup		
Diagnostic Tools		
Home		

4. Push or to select [Backlight], then push .

10:00 am	FWD	Tools
Data Logger		
Backlight		
Drive Information		
Back	Home	Setup

5. Push  or  to select [ON] or [OFF], then push .

10:00 am	FWD	Tools
LCD backlight ON/OFF Selection		
OFF		
ON		
Back	Home	





- [ON]: Backlight is always ON
- [OFF]: Backlight turns OFF after set length of time.

6. Push  (Setup).

10:00 am	FWD	Tools
Data Logger		
Backlight		
Drive Information		
Back	Home	Setup

7. Push .

10:00 am	FWD	Setup
Energy Saving		
Time to turn off LCD backlight		
01-38	60	(60)sec
Back	Home	

8. Push  or  to select the digit, then push  or  to change the value.

10:00 am	FWD	Parameters
Time to turn off LCD backlight		
01-38	0 60	sec
Default : 60sec		
Range : 10~300		
Back	Default	Min/Max

9. When you are done changing the value, push .

10:00 am	FWD	Parameters
Time to turn off LCD backlight		
01-38	030	sec
Default : 60sec		
Range : 10~300		
Back	Default	Min/Max



The procedure to set the backlight to turn OFF automatically is complete.

◆ Show Information about the Drive

The procedure in this section shows how to show the drive model, maximum applicable motor output (HD/ND), rated output current (HD/ND), software version, and the serial number on the keypad.



1. Push  (Home) to show the HOME screen.







Note:

- The keypad will show [Home] in the top right corner when the HOME screen is active.
- If [Home] is not shown on , push  (Back) to show [Home] on .

2. Push **F2** (Menu).

10:00 am	FWD	Rdy	Home
Freq Reference (AI)			0.00
U1-01	Hz		0.00
Output Frequency			0.00
U1-02	Hz		0.00
Output Current			0.00
U1-03	A		0.00
Menu			

3. Push  or  to select [Diagnostic Tools], then push .

10:00 am	FWD	Menu
	User Custom Parameters	
	Parameter Backup/Restore	
	Modified Param / Fault Log	
	Auto-Tuning	
	Initial Setup	
	Diagnostic Tools	
Home		

4. Push  or  to select [Drive Information], then push .

10:00 am	FWD	Tools
Data Logger		
Backlight		
Drive Information		
Back		Home

The keypad will show the drive information.

10:00 am	FWD	Tools
GA800		
200V, 22.0/30.0kW		
88.00/110.0A		
<VSAA09010>		
S/N: J0065F575310100		
Back		Home

A - Drive Series

B - Maximum Applicable Motor Output (HD/ND)

C - Rated Output Current (HD/ND)

D - Drive Software Version

E - Serial Number



◆ Write Automatically Backed-up Parameters to the Drive

You can automatically back up parameters to the keypad connected to the drive and write those parameters to a different drive as specified by the settings of *o3-06 [Auto Parameter Backup Selection]* and *o3-07 [Auto Parameter Backup Interval]*.

Note:

- Set *o3-06 = 1 [Auto Parameter Backup Selection = Enabled]* in each drive to which you will write the parameters.
- This operation is not available when the parameters in the keypad and the parameters on the other drives are set to the same values.

1. Connect the keypad to the drive.

2. Push  or  to select [Yes] and then push .

10:00 am FWD Backup
Drive and Keypad mismatch. Should the parameters be restored? -----
No
Yes ▶

3. Push  or  to select [Yes] and then push .

10:00 am FWD Backup
Starting restore. Are you sure you want to start? -----
No
Yes ▶

The keypad will show the “End” message when the write process is complete.

4.7 Automatic Parameter Settings Optimized for Specific Applications (Application Presets)

The drive has application presets to set the necessary parameters for different applications to their best values. Use *A1-06* from [User Custom Parameters] on the Main menu to check the parameters that were automatically changed by the application preset function.

Note:

Make sure that you set *A1-03* = 2220, 3330 [Initialize Parameters = 2-Wire Initialization, 3-Wire Initialization] to initialize parameters before you set *A1-06*.

This section shows the procedure to set an application preset.

1. Push **F2** (Home) to show the HOME screen.

Note:

- The keypad will show [Home] in the top right corner when the HOME screen is active.
- If [Home] is not shown on **F2**, push **F1** (Back) to show [Home] on **F2**.

2. Push **F2** (Menu).

10:00 am	FWD	Rdy	Home
Freq Reference (AI)			
U1-01	Hz		0.00
Output Frequency			
U1-02	Hz		0.00
Output Current			
U1-03	A		0.00
Menu			

3. Push **▲** or **▼** to select [Parameters], then push **↵**.



10:00 am	FWD		Menu
Monitors			
Parameters			
User Custom Parameters			
Parameter Backup/Restore			
Modified Param / Fault Log			
Auto-Tuning			
Home			

4. Push **▲** or **▼** to select [A Initialization Parameters], then push **↵**.



10:00 am	FWD		Parameters
A Initialization Parameters			
b Application			
C Tuning			
d References			
E Motor Parameters			
F Options			
Back		Home	

5. Push **▲** or **▼** to select [A1 Initialization], then push **↵**.

10:00 am	FWD		Parameters
A1 Initialization			
A2 User Parameters			
Back		Home	

6. Push  or  to select A1-06, then push .

10:00 am	FWD	Parameters
Password		
A1-04	0	(0)
Application Preset		
A1-06	1	(0)
DriveWorksEZ Function Selection		
A1-07	0	(0)
Back	Home	

7. Push  or  to change the value, then push .

10:00 am	FWD	Parameters
Application Preset		
A1-06		3
Exhaust fan		
Default : 0		
Back	Default	

The parameter setting procedure is complete.

Note:

- You cannot change the value set in A1-06. To select an application preset, first set A1-03 = 2220 to initialize parameters and then make a selection to A1-06. If initializing all parameters will cause a problem, it is not necessary to change settings.
- When the drive changes to the A1-06 setting, it will also reset the parameters automatically registered to A2-17 to A2-32 [User Parameters 17 to 32] when A2-33 = 1 [User Parameter Auto Selection = Enabled: Auto Save Recent Params].

4.8 Auto-Tuning

Auto-Tuning uses motor characteristics to automatically set drive parameters for vector control. Think about the type of motor, drive control method, and the motor installation environment and select the best Auto-Tuning method.

The keypad will show the messages with prompts to input the necessary parameter information. These prompts are specified by the selected Auto-Tuning method and the control method setting in *A1-02*.

◆ Auto-Tuning for Induction Motors

This section gives information about Auto-Tuning for induction motors. Auto-Tuning sets these parameters:

- Motor parameters *E1-xx*, *E2-xx* (*E3-xx*, *E4-xx* for motor 2)
- Speed feedback detection-use *F1-xx* (only with CLV)

Note:

Do Stationary Auto-Tuning if you cannot do Rotational Auto-Tuning. There can be large differences between the measured results and the motor characteristics when Auto-Tuning is complete. Examine the parameters for the measured motor characteristics after you do Stationary Auto-Tuning.

Table 4.6 Types of Auto-Tuning for Induction Motors

Mode	Parameter Settings	Application Conditions and Benefits	Applicable Control Method (A1-02 Setting)				
			V/f (0)	CL-V/f (1)	OLV (2)	CLV (3)	AOLV (4)
Rotational Auto-Tuning	T1-01 = 0	<ul style="list-style-type: none"> • When you can decouple the motor and load the motor can rotate freely while Auto-Tuning. • When operating motors that have fixed output characteristics. • When it is necessary to use motors that have high-precision control. • When you cannot decouple the motor and load, but the motor load is less than 30%. 	x	x	x	x	x
Stationary Auto-Tuning 1	T1-01 = 1	<ul style="list-style-type: none"> • When you cannot decouple the motor and load, but the motor load is more than 30%. • When the information from the motor test report or motor nameplate is not available. With Stationary Auto-Tuning, the energized drive stays stopped for approximately 1 minute. During this time, the drive automatically measures the necessary motor parameters. • When operating the motor with a light load after Auto-Tuning. The drive can automatically calculate the motor parameter settings necessary for torque control. Set <i>T1-12 = 1 [Test Mode Selection = Yes]</i> to do a test run after Auto-Tuning. 	-	-	x	x	x
Line-to-Line Resistance	T1-01 = 2	<ul style="list-style-type: none"> • After Auto-Tuning, the wiring distance between the drive and motor changed by 50 m or more. • When the wiring distance is 50 m or more in the V/f Control mode. • When the motor output and drive capacity are different. 	x	x	x	x	x

■ Input Data for Induction Motor Auto-Tuning

To do Auto-Tuning, input data for the items in [Table 4.7](#) that have an "x". Before starting Auto-Tuning, prepare the motor test report or record the information on the motor nameplate as a reference.

Table 4.7 Input Data for Induction Motor Auto-Tuning

Input Data	Parameter	Unit	Auto-Tuning Mode (T1-01 Setting)		
			Rotational Auto-Tuning (0)	Stationary Auto-Tuning 1 (1)	Line-to-Line Resistance (2)
Motor Rated Power	T1-02	kW	x	x	x
Motor Rated Voltage	T1-03	V	x	x	-
Motor Rated Current	T1-04	A	x	x	x

4.8 Auto-Tuning

Input Data	Parameter	Unit	Auto-Tuning Mode (T1-01 Setting)		
			Rotational Auto-Tuning (0)	Stationary Auto-Tuning 1 (1)	Line-to-Line Resistance (2)
Motor Base Frequency	T1-05	Hz	x	x	-
Number of Motor Poles	T1-06	-	x	x	-
Motor Base Speed	T1-07	min ⁻¹	x	x	-
Encoder Pulse Count (PPR)	T1-08	-	o *1	o *1	-
Motor No-Load Current	T1-09	A	-	x	-
Motor Rated Slip Frequency	T1-10	Hz	-	o *2	-
Motor Iron Loss	T1-11	W	o *3	-	-
Test Mode Selection *4	T1-12	-	-	o *5	-
No-load voltage	T1-13	V	o *6	o *6	-

*1 Input this value when $A1-02 = 3$ [Control Method Selection = Closed Loop Vector].

*2 Shows 0 Hz as the default value. If you do not know the Motor Rated Slip Frequency, keep the setting at 0 Hz.

*3 Input this value when $A1-02 = 0$ or 1 [Control Method Selection = V/f Control or V/f Control w/ PG].

*4 If $T1-12 = 1$ [Test Mode Selection = Yes], when you run the motor in Drive Mode for the first time after Auto-Tuning, the drive will automatically set $E2-02$ [Motor Rated Slip] and $E2-03$ [Motor No-Load Current].

*5 Input this value when $T1-10$ [Motor Rated Slip Frequency] = 0 Hz.

*6 Set the same value to No-Load Voltage as $T1-03$ [Motor Rated Voltage] to get the same characteristics using Yaskawa 1000-Series drives or other legacy models.

◆ Auto-Tuning for Motor Parameters for PM Motor

This section gives information about Auto-Tuning for PM motors. Auto-Tuning sets these parameters:

- Motor parameters $E1-xx$, $E5-xx$
- Speed feedback detection uses $F1-xx$ (only with CLV/PM)

Table 4.8 Auto-Tuning for PM Motors

Mode	Parameter Settings	Application Conditions and Benefits	Applicable Control Method (A1-02 Setting)		
			OLV/PM (5)	AOLV/PM (6)	CLV/PM (7)
PM Motor Parameter Settings	T2-01 = 0	<ul style="list-style-type: none"> • When the information from the motor test report or motor nameplate is available. • Rotational/Stationary Auto-Tuning that energizes the motor is not done. Manually input the necessary motor parameters. 	x	x	x
PM Stationary Auto-Tuning	T2-01 = 1	<ul style="list-style-type: none"> • When the information from the motor test report or motor nameplate is not available. <p>Note: With Stationary Auto-Tuning, the energized drive stays stopped for approximately 1 minute. During this time, the drive automatically measures the necessary motor parameters.</p>	x	x	x
PM Stationary Auto-Tuning for Stator Resistance	T2-01 = 2	<ul style="list-style-type: none"> • After Auto-Tuning, the wiring distance between the drive and motor changed by 50 m or more. • When the motor output and drive capacity are different. 	x	x	x
Z-Pulse Offset (Pole Position)	T2-01 = 3	<ul style="list-style-type: none"> • When you do not know the encoder Z-pulse offset. • When the encoder was replaced • If you have compensated for the deviation from Z phase ($\Delta\theta$). <p>Note: The motor will rotate slowly while the drive measures the encoder base position.</p>	-	-	x

Mode	Parameter Settings	Application Conditions and Benefits	Applicable Control Method (A1-02 Setting)		
			OLV/PM (5)	AOLV/PM (6)	CLV/PM (7)
PM Rotational Auto-Tuning	T2-01 = 4	<ul style="list-style-type: none"> When the information from the motor test report or motor nameplate is not available. When you can decouple the motor and load the motor can rotate freely while Auto-Tuning. Values measured during Auto-Tuning are automatically set to the motor parameters. 	x	x	x
High Frequency Injection Auto-Tuning	T2-01 = 5	<ul style="list-style-type: none"> Automatically determines the control parameters required to set $n8-35 = 1$ [Initial Pole Detection Method = High Frequency Injection] or $n8-57 = 1$ [HFI Overlap Selection = Enabled]. Applicable to IPM motors only. Perform tuning with the motor connected to the drive. <p>Note: When you want to set $n8-35 = 1$ or $n8-57 = 1$, perform High Frequency Injection Auto-Tuning. Configure the drive with the data from the motor nameplate before performing High Frequency Injection Auto-Tuning. High Frequency Injection Auto-Tuning automatically makes adjustments while it is stopped but still energized.</p>	x	x	x

■ Input Data for PM Motor Auto-Tuning

To do Auto-Tuning, input data for the items in Table 4.9 and Table 4.10 that have an "x". Before starting Auto-Tuning, prepare the motor test report or record the information on the motor nameplate as a reference.

Table 4.9 Input Data for PM Motor Auto-Tuning

Input Data	Parameter	Unit	Auto-Tuning Mode (T2-01 Setting)					
			PM Motor Parameter Settings (0)			PM Stationary Auto-Tuning (1)		PM Stationary Auto-Tuning for Stator Resistance (2)
Control method selection	A1-02	-	5, 6, 7	5	6, 7	5	6, 7	5, 6, 7
PM Motor Code Selection	T2-02	-	Motor code of Yaskawa motor *1	FFFF *2	FFFF *2	-	-	-
PM Motor Type	T2-03	-	-	-	-	x	x	-
PM Motor Rated Power	T2-04	kW	-	x	x	x	x	-
PM Motor Rated Voltage	T2-05	V	-	x	x	x	x	-
PM Motor Rated Current	T2-06	A	-	x	x	x	x	x
PM Motor Base Frequency	T2-07	Hz	-	x	-	x	-	-
Number of PM Motor Poles	T2-08	-	-	x	x	x	x	-
PM Motor Base Speed	T2-09	min ⁻¹	-	-	x	-	x	-
PM Motor Stator Resistance	T2-10	Ω	x	x	x	-	-	-
PM Motor d-Axis Inductance	T2-11	mH	x	x	x	-	-	-
PM Motor q-Axis Inductance	T2-12	mH	x	x	x	-	-	-
Back-EMF Units Selection	T2-13	-	x	x	x	-	-	-
Back-EMF Voltage Constant (Ke)	T2-14	*3	x	x	x	-	-	-
Pull-In Current Level	T2-15	%	-	-	-	x	x	-
Encoder Pulse Count (PPR)	T2-16	-	*4	-	*4	-	*4	-
Encoder Z-Pulse Offset for PM Motor	T2-17	Degrees	*4	-	*4	-	*4	-

*1 Set the motor code for a Yaskawa PM motor.

*2 Set the motor code to FFFF for a PM motor from a different manufacturer.

*3 Changes when the value set in T2-13 changes.

*4 Input this value when A1-02 = 7 [Control Method Selection = PM Closed Loop Vector Control].

Table 4.10 Input Data for PM Motor Auto-Tuning

Input Data	Parameter	Unit	Auto-Tuning Mode (T2-01 Setting)				
			Z-Pulse Offset (Pole Position) (3)	PM Rotational Auto-Tuning (4)			High Frequency Injection Auto-Tuning (5)
Control method selection	A1-02	-	7	5	6	7	5, 6, 7
PM Motor Code Selection	T2-02	-	-	-	-	-	-
PM Motor Type	T2-03	-	-	x	x	x	-
PM Motor Rated Power	T2-04	kW	-	x	x	x	-
PM Motor Rated Voltage	T2-05	V	-	x	x	x	-
PM Motor Rated Current	T2-06	A	-	x	x	x	-
PM Motor Base Frequency	T2-07	Hz	-	x	-	-	-
Number of PM Motor Poles	T2-08	-	-	x	x	x	-
PM Motor Base Speed	T2-09	min ⁻¹	-	-	x	x	-
PM Motor Stator Resistance	T2-10	Ω	-	-	-	-	-
PM Motor d-Axis Inductance	T2-11	mH	-	-	-	-	-
PM Motor q-Axis Inductance	T2-12	mH	-	-	-	-	-
Back-EMF Units Selection	T2-13	-	-	-	-	-	-
Back-EMF Voltage Constant (Ke)	T2-14	<i>*I</i>	-	-	-	-	-
Pull-In Current Level	T2-15	%	-	x	x	x	-
Encoder Pulse Count (PPR)	T2-16	-	-	-	-	x	-
Encoder Z-Pulse Offset for PM Motor	T2-17	Degrees	-	-	-	-	-

*1 Changes when the value set in T2-13 changes.

◆ Auto-Tuning in EZ Open Loop Vector Control Method

This section gives information about the Auto-Tuning mode for EZ Open Loop Vector Control. Auto-Tuning will set the E9-xx parameters.

Table 4.11 EZ Tuning Mode Selection

Mode	Parameter Settings	Application Conditions and Benefits	Applicable Control Method (A1-02 Setting)
Motor Parameter Setting	T4-01 = 0	<ul style="list-style-type: none"> Applicable when driving SynRM (Synchronous Reluctance Motors). Suitable for derating torque applications, for example fans and pumps. 	EZOLV (8)
Line-to-Line Resistance	T4-01 = 1	<ul style="list-style-type: none"> After Auto-Tuning, the wiring distance between the drive and motor changed by 50 m or more. When the motor output and drive capacity are different. 	EZOLV (8)

■ Auto-Tuning Input Data in EZ Open Loop Vector Control Method

To do Auto-Tuning, input data for the items in Table 4.12 that have an "x". Before starting Auto-Tuning, prepare the motor test report or record the information on the motor nameplate as a reference.

Table 4.12 Auto-Tuning Input Data in EZ Open Loop Vector Control Method

Input Data	Parameter	Unit	Auto-Tuning Mode (T4-01 Setting)	
			Motor Parameter Setting (0)	Line-to-Line Resistance (1)
Motor Type Selection	T4-02	-	x	-
Motor Max Revolutions	T4-03	min ⁻¹	x	-
Motor Rated Revolutions	T4-04	min ⁻¹	x	-
Motor Rated Frequency	T4-05	Hz	x	-
Motor Rated Voltage	T4-06	V	x	-
PM Motor Rated Current (FLA)	T4-07	A	x	x
PM Motor Rated Power (kW)	T4-08	kW	x	-
Number of Motor Poles	T4-09	-	x	-

◆ Control Tuning

To increase drive responsiveness and prevent hunting, use Auto-Tuning to automatically adjust the control-related parameters.

These types of Auto-Tuning are available for the control system:

- Inertia Tuning
- ASR Tuning
- Deceleration Rate Tuning
- KEB Tuning

Note:

If you do Control Tuning, you cannot set $H1-xx = 16$ [Motor 2 Selection]. Do not do Control Tuning for applications that switch between motor 1 and motor 2.

Table 4.13 Control Loop Tuning Selection

Mode	T3-00	Application Conditions and Benefits	Applicable Control Method (A1-02 Value)								
			V/f (0)	CL-V/f (1)	OLV (2)	CLV (3)	AOLV (4)	OLV/PM (5)	AOLV/ PM (6)	CLV/PM (7)	EZOLV (8)
Inertia Tuning	0	<ul style="list-style-type: none"> • For Feed Forward Control • When $L2-29 = 1$ [Kinetic Energy Backup Method = Single Drive KEB Ride-Thru 2]. • When MFDI $H1-xx = 7A$ [KEB Ride-Thru 2 Activate (N.C.)]. 	-	-	-	x	-	-	-	x	-
ASR Tuning	1	To let the set response frequency (including Inertia Tuning) automatically adjust the ASR gain.	-	-	-	x	-	-	-	x	-
Deceleration Rate Tuning	2	To automatically adjust the deceleration rate to prevent an <i>ov</i> [Overvoltage] fault.	x	x	x	x	x	x	x	x	x
KEB Tuning	3	<ul style="list-style-type: none"> • To automatically adjust parameter settings to prevent an <i>ov</i> [Overvoltage] fault with the KEB Ride-Thru function. • When $L3-11 = 1$ [Overvoltage Suppression Select = Enabled]. 	x	x	x	x	x	x	x	x	x

Table 4.14 Input Data for Control Tuning

Input Data	Parameters	Unit	Auto-Tuning Mode (T3-00 Value)			
			Inertia Tuning (0)	ASR (Speed Regulator) (1)	Dec Rate Tuning (2)	KEB Tuning (3)
Test Signal Frequency	T3-01	Hz	x	x	-	-
Test Signal Amplitude	T3-02	Rad	x	x	-	-
Motor Inertia	T3-03	Kg·m ²	x	x	-	-
System Response Frequency	T3-04	Hz	-	x	-	-

■ Inertia Tuning

Inertia Tuning uses the motor speed and torque reference to estimate the system inertia and automatically sets the drive parameters related to the inertia ratio of the machinery and motor. Use Inertia Tuning for Feed Forward control or when $H1-xx = 7A$ [MFDI Function Select = KEB Ride-Thru 2 Activate (N.C.)].

Inertia tuning identifies the load inertia and optimizes the speed loop gain and feed forward gain to get a high level of control capability. You can set the speed response without thinking about the load, which increases the precision when synchronizing multiple drives. Since the motor can continue to operate during a power outage, Inertia Tuning keeps the best ramp to stop deceleration curve for KEB Ride-Thru.

■ ASR Tuning

ASR Tuning estimates the motor load inertia and automatically sets the parameters. ASR Tuning also uses the measured load inertia value to do an automatic adjustment after calculating the proportional gain of speed control (ASR).

■ Deceleration Rate Tuning

Deceleration Rate Tuning automatically sets the deceleration rate to prevent an *ov* [Overvoltage] fault during motor deceleration. Set $C1-11$ [Accel/Decel Time Switchover Freq] first to automatically set parameters $C1-02$ [Deceleration Time 1] (high speed range) and $C1-08$ [Deceleration Time 4] (low speed range).

■ KEB Tuning

KEB Tuning automatically sets parameters used for the KEB Ride-Thru function and for the overvoltage suppression function.

Control Tuning automatically sets the parameters in [Table 4.15](#) to the best values.

Table 4.15 Parameters set in Control Tuning

Parameters Automatically Set	Inertia Tuning	ASR Tuning	Deceleration Rate Tuning	KEB Tuning
C1-02 [Deceleration Time 1]	-	-	x	-
C1-08 [Deceleration Time 4]	-	-	x *1	-
C1-09 [Fast Stop Time]	-	-	-	x *2
C5-01 [ASR Proportional Gain 1]	-	x	-	-
C5-17 [Motor Inertia]	x	x	-	-
C5-37 [Motor 2 Inertia]	x	x	-	-
C5-18 [Load Inertia Ratio]	x	x	-	-
C5-38 [Motor 2 Load Inertia Ratio]	x	x	-	-
L2-06 [Kinetic Energy Backup Decel Time]	-	-	-	x *3
L3-24 [Motor Accel Time @ Rated Torque]	x	x	-	-
L3-25 [Load Inertia Ratio]	x	x	-	x

Parameters Automatically Set	Inertia Tuning	ASR Tuning	Deceleration Rate Tuning	KEB Tuning
n5-02 [Motor Inertia Acceleration Time]	x	x	-	-
n5-03 [Feed Forward Control Gain]	x	x	-	-

- *1 The drive automatically sets C1-08 [Deceleration Time 4] only when C1-11 [Accel/Decel Time Switchover Freq] $\neq 0$.
- *2 When L2-29 = 0 [Kinetic Energy Backup Method = Single Drive KEB Ride-Thru 1], the drive will automatically adjust C1-09 [Fast Stop Time] and will not adjust L2-06 [Kinetic Energy Backup Decel Time]. If the Fast Stop time must not change, do not do KEB Tuning.
- *3 When L2-29 = 1, 2, or 3 [Kinetic Energy Backup Method = Single Drive KEB Ride-Thru 2, System KEB Ride-Thru 1, or System KEB Ride-Thru 2], the drive will automatically adjust L2-06 [Kinetic Energy Backup Decel Time].

◆ Precautions before Auto-Tuning

Examine the topics in this section before you start Auto-Tuning.

■ Prepare for Basic Auto-Tuning

- You must input data from the motor nameplate or motor test report to do Auto-Tuning. Make sure that this data is available before Auto-Tuning the drive.
- For best performance, make sure that the drive input supply voltage is equal to or more than the motor rated voltage.

Note:

Better performance is possible when you use a motor with a rated voltage that is less than the input supply voltage (by 20 V for 200 V class models or by 40 V for 400 V class models). This is very important when operating the motor at more than 90% of base speed, where high torque precision is necessary. If the input power supply is equal to the motor rated voltage, the drive output voltage will not be sufficient, and performance will decrease.

- Push  on the keypad to cancel Auto-Tuning.
- If a Safe Disable input signal is input to the drive during Auto-Tuning, Auto-Tuning measurements will not complete successfully. If this occurs, cancel the Auto-Tuning, then do it again.
- Table 4.16 shows the status of input/output terminals during Auto-Tuning.

Table 4.16 Status of Input/Output Terminals during Auto-Tuning

Auto-Tuning Type	Mode	Multifunctional input	Multifunctional output *1	
Induction Motor Auto-Tuning	Rotational	Rotational Auto-Tuning	Disabled	Functions the same as during usual operation.
	Stationary	Stationary Auto-Tuning 1	Disabled	Keeps the status at the start of Auto-Tuning.
		Line-to-Line Resistance	Disabled	Keeps the status at the start of Auto-Tuning.
PM Motor Auto-Tuning	Rotational	Z-Pulse Offset (Pole Position)	Disabled	Keeps the status at the start of Auto-Tuning.
		PM Rotational Auto-Tuning	Disabled	Functions the same as during usual operation.
	Stationary	PM Motor Parameter Settings	Disabled	Disabled
		PM Stationary Auto-Tuning	Disabled	Keeps the status at the start of Auto-Tuning.
EZ Tuning	Stationary	PM Stationary Auto-Tuning for Stator Resistance	Disabled	Keeps the status at the start of Auto-Tuning.
		Motor Parameter Setting	Disabled	Disabled
ASR and Inertia Tuning	Rotational	Line-to-Line Resistance	Disabled	Keeps the status at the start of Auto-Tuning.
		Inertia Tuning	Disabled	Functions the same as during usual operation.
		ASR (Speed Regulator)	Disabled	Functions the same as during usual operation.
		Deceleration Rate Tuning	Disabled	Functions the same as during usual operation.
		KEB Tuning	Disabled	Functions the same as during usual operation.

*1 A terminal to which H2-xx = E [MFDO Function Select = Fault] is assigned functions the same as during usual operation.

WARNING! Crush Hazard. Wire a sequence that will not let a multi-function output terminal open the holding brake during Stationary Auto-Tuning. If the holding brake is open during Stationary Auto-Tuning, it can cause serious injury or death.

WARNING! Sudden Movement Hazard. Before you do Rotational Auto-Tuning, disconnect the load from the motor. The load can move suddenly and cause serious injury or death.

WARNING! Crush Hazard. Rotational Auto-Tuning rotates the motor at 50% or more of the motor rated frequency. Make sure that there are no issues related to safety in the area around the drive and motor. Increased motor frequency can cause serious injury or death.

WARNING! Electrical Shock Hazard. During Auto-Tuning, the motor will receive high voltage when the motor is stopped. Do not touch the motor until Auto-Tuning is complete. If you touch a motor that is energized, it can cause serious injury or death.

■ Precautions before Rotational Auto-Tuning

WARNING! Electrical Shock Hazard. During Auto-Tuning, the motor will receive high voltage when the motor is stopped. Do not touch the motor until Auto-Tuning is complete. If you touch a motor that is energized, it can cause serious injury or death.

- Uncouple the drive from the motor before Rotational Auto-Tuning to prevent drive malfunction. If you do Rotational Auto-Tuning with the motor connected to a load that is more than 30% of the motor duty rating, the drive will not correctly calculate the motor parameters and the motor can operate incorrectly.
- When the load is 30% or less of the motor duty rating, you can do Auto-Tuning with the motor connected to a load.
- Make sure that the motor magnetic brake is released.
- Make sure that external force from the machine will not cause the motor to rotate.

■ Precautions before Stationary Auto-Tuning

- Make sure that the motor magnetic brake is not open.
- Make sure that external force from the machine will not cause the motor to rotate.

WARNING! Electrical Shock Hazard. During Auto-Tuning, the motor will receive high voltage when the motor is stopped. Do not touch the motor until Auto-Tuning is complete. If you touch a motor that is energized, it can cause serious injury or death.

Automatically Set E2-02 [Motor Rated Slip] and E2-03 [Motor No-Load Current]

If $T1-12 = 1$ [Test Mode Selection = Yes] when selecting Stationary Auto-Tuning, the drive will automatically set motor parameters E2-02 [Motor Rated Slip] and E2-03 [Motor No-Load Current] after Auto-Tuning is complete when you use the motor for the first time in Drive Mode.

After Stationary Auto-Tuning is complete, use this procedures to do the operation in test mode:

1. Check the E2-02 and E2-03 values on the “Modified Parameters/Fault Log” screen or the “Parameters” screen.
2. Operate the motor in Drive Mode with these conditions:
 - Make sure that you connect all wiring between the drive and motor
 - Make sure that a mechanical brake on the motor shaft is not locked
 - The maximum motor load must be 30% of the rated load.
 - Keep a constant speed of 30% of E1-06 [Base Frequency] (default value = maximum frequency) or more for 1 second or longer.
3. After the motor stops, check the E2-02 and E2-03 values on the “Modified Parameters/Fault Log” screen or the “Parameters” screen again.
4. Make sure that the input data is correct.
When the settings in E2-02 and E2-03 are different than in step 1, the drive set the values automatically.

Note:

- If you cannot operate the motor with the conditions in step 2 for the first test run and if the values set in *E2-02* and *E2-03* are much different than data in the official test report for the motor and the data listed in *Defaults by Drive Model and Duty Rating ND/HD on page 598*, these problems can occur:
 - Motor vibrations or hunting
 - Not sufficient torque
 - Overcurrent

In elevator applications, there is a risk of the cage falling and causing personal injury.

Do one of these precautions to decrease the risk:

- After doing Stationary Auto-Tuning, operate the drive as specified by the conditions and procedure above.
- Set $T1-12 = 0$ [*Test Mode Selection = No*].
- Do Rotational Auto-Tuning.
- If you initialize the drive after completing Step 1, do the procedure beginning from Step 1 again.
- For general-purpose motors, the target value for *E2-02* is 1 Hz to 3 Hz, and the target rated current for *E2-03* is 30% to 65%. Larger capacity motors have a lower rated slip, and a smaller ratio for the no-load current rated current. Refer to *Defaults by Drive Model and Duty Rating ND/HD on page 598*.

■ Precautions before Stationary Auto-Tuning for Line-to-Line Resistance and Stator Resistance Auto-Tuning

In V/f control, when the motor cable is 50 meters (164 feet) or longer, do Stationary Auto-Tuning for Line-to-Line Resistance.

WARNING! *Electrical Shock Hazard. During Auto-Tuning, the motor will receive high voltage when the motor is stopped. Do not touch the motor until Auto-Tuning is complete. If you touch a motor that is energized, it can cause serious injury or death.*

■ Precautions before Inertia Tuning and ASR Tuning

Before Inertia Tuning or ASR Tuning, check these items:

WARNING! *Electrical Shock Hazard. During Auto-Tuning, the motor will receive high voltage when the motor is stopped. Do not touch the motor until Auto-Tuning is complete. If you touch a motor that is energized, it can cause serious injury or death.*

- Do rotational motor parameter tuning or look at the motor test report or nameplate to enter the values manually.
- Make sure that the motor magnetic brake is released.
- Connect the motor and load.
- Make sure that external force from the machine will not cause the motor to rotate.
- Make sure that the machine does not prevent reverse rotation. You cannot do Inertia Tuning or ASR Tuning with machines that prevent reverse rotation.
- When the motor can rotate during Auto-Tuning, check for safety issues near the drive, motor, and machine.

Note:

If there are gears between the machine and motor shaft, Inertia Tuning or ASR Tuning are possibly not applicable.

■ Precautions before Using Deceleration Rate Tuning and KEB Tuning

Before Deceleration Rate Tuning or KEB Tuning, check these items:

Note:

- Do not do Deceleration Rate Tuning if you use a braking resistor unit or a regenerative converter.
- Do Deceleration Rate Tuning and KEB Tuning with the load attached to the motor.
- Do not do Deceleration Rate Tuning or KEB Tuning for these applications:
 - In Deceleration Rate Tuning and KEB Tuning, the drive will automatically rotate the motor forward and accelerate and decelerate the motor again and again.
 - On a machine that does not let the motor rotate forward
 - In applications with a small range of operation (trolleys and other such applications that can only move linearly)
 - Applications where sudden acceleration and sudden deceleration are not applicable.
- To do KEB Tuning with the external main circuit capacitors connected to the drive, set *L3-26 [Additional DC Bus Capacitors]* then do KEB Tuning.
- Do not do KEB Tuning or Deceleration Rate Tuning if the drive is set to use $H1-xx = 16$ [*MFDI Function Select = Motor 2 Selection*]. Failure to obey can cause an *ov [Overvoltage]* fault.

4.9 Test Run

After you use the Setup Wizard to set the basic parameters and Auto-Tune the drive, the next step is to do a test run.

WARNING! Crush Hazard. Test the system to make sure that the drive operates safely after you wire the drive and set parameters. If you do not test the system, it can cause damage to equipment or serious injury or death.

◆ No-Load Test Run

Before connecting the motor to the machine, make sure that you check the operation status of the motor.

■ Precautions before Operation

Before rotating the motor, check these items:

- Check for safety issues near the drive, motor, and machine.
- Make sure that all emergency stop circuits and machine safety mechanisms are operating correctly.



■ Items to Check before Operation

Check these items before operation:

- Is the motor rotating in the forward direction?
- Is the motor rotating smoothly (no unusual sounds or unusual vibrations)?
- Does the motor accelerate/decelerate smoothly?



◆ Do a No-Load Test Run

Do these steps for a no-load test run:

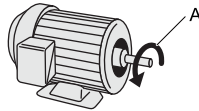
1. Energize the drive, or push **F2** to show the HOME screen.
If [Home] is not shown on **F2**, push **F1** (Back) to show [Home] on **F2**.
2. Push **LO/RE** to illuminate the LOCAL/REMOTE indicator.
3. Push  to show *d1-01 [Reference 1]*, and set it to 6.00 Hz.
4. Push .
The RUN indicator illuminates, and the motor runs at 6.00 Hz in the forward direction.
5. Make sure that the motor is rotating in the correct direction and that the drive does not show a fault.
If the drive detects a fault, remove the cause.



A - Forward Rotation of Motor (Counter Clockwise Direction as Seen from Load Shaft)

6. Push  to increase the frequency reference value.
Change the setting value in increments of 10 Hz if necessary and examine the response.
7. Each time you increase the setting value, use *U1-03 [Output Current]* to check the drive output current.
When the output current of the drive is not more than the motor rated current, the status is correct.
Ex.: 6 Hz → 20 Hz → 30 Hz → 40 Hz → 50 Hz → 60 Hz
8. Make sure that the motor rotates correctly, then push .
The RUN indicator will flash. When the motor stops, the indicator will go out.

◆ Actual-Load Test Run

Test the operation without a load, then connect the motor and machine to do a test run.

■ Precautions before Operation

Before rotating the motor, check these items:









- Check for safety issues near the drive, motor, and machine.
- Make sure that all emergency stop circuits and machine safety mechanisms are operating correctly.
- Make sure that the motor is fully stopped.
- Connect the motor with the machine.
Make sure that there are no loose installation screws and that the motor load shafts and machine junctions are correctly secured.
- Keep the keypad near you to push  immediately if there is unusual or incorrect operation.

■ Items to Check before Operation

- Make sure that the direction of the machine operation is correct (The motor must rotate in the correct direction).
- Make sure that the motor accelerates and decelerates smoothly.

◆ Do an Actual-Load Test Run

Connect the motor and machine, then do the test run with the same procedure you used for the no-load test run.

- Make sure that *U1-03 [Output Current]* is not too high.
 1. Energize the drive, or push  (Home) to show the HOME screen.
If [Home] is not shown on , push  (Back) to show [Home] on .
 2. Set *d1-01 [Reference 1]* to 6.00 Hz.
 3. Push  to illuminate the LOCAL/REMOTE indicator.
 4. Push .
The RUN indicator illuminates, and the motor runs at 6.00 Hz in the forward direction.
 5. Make sure that the motor is rotating in the correct direction and that the drive does not show a fault.
If the drive detects a fault, remove the cause.
 6. Push  to increase the frequency reference value.
Change the setting value in increments of 10 Hz if necessary and examine the response.
 7. Each time you increase the setting value, use *U1-03 [Output Current]* to check the drive output current.
When the output current of the drive is not more than the motor rated current, the status is correct.
Ex.: 6 Hz → 20 Hz → 30 Hz → 40 Hz → 50 Hz → 60 Hz
 8. Make sure that the motor rotates correctly, then push .
The RUN indicator will flash. When the motor stops, the indicator will go out.
 9. Change the frequency reference and direction of motor rotation, and make sure that there are no unusual sounds or vibrations.
 10. If there are hunting or oscillation errors caused by control function, adjust the settings to stop the errors.

4.10 Fine Tuning during Test Runs (Adjust the Control Function)

This section gives information about the adjustment procedures to stop hunting or oscillation errors caused by control function during a test run. Adjust the applicable parameters as specified by your control method and drive status.

- [V/f Control and Closed Loop V/f Control on page 202](#)
- [Open Loop Vector Control Method on page 203](#)
- [Closed Loop Vector Control Method on page 204](#)
- [Advanced Open Loop Vector Control Method on page 205](#)
- [Fine-Tuning Open Loop Vector Control for PM Motors on page 206](#)
- [Advanced Open Loop Vector Control Method for PM on page 207](#)
- [Closed Loop Vector Control Method for PM on page 207](#)
- [EZ Open Loop Vector Control Method on page 208](#)

Note:

This section only lists frequently adjusted parameters. If you must adjust parameters that have a higher degree of precision, contact Yaskawa.

◆ V/f Control and Closed Loop V/f Control

Table 4.17 Parameters for Fine Tuning the Drive (V/f and CL-V/f)

Issue	Parameter Number	Possible Solutions	Default	Recommended Setting
Hunting or oscillation at mid-range speeds (10 Hz to 40 Hz)	n1-02 [Hunting Prevention Gain Setting]	<ul style="list-style-type: none"> • If torque is not sufficient with heavy loads, decrease the setting value. • If hunting or oscillation occur with light loads, increase the setting value. • If hunting occurs with a low-inductance motor, for example a motor with a larger frame size or a high-frequency motor, lower the setting value. 	1.00	0.10 - 2.00
<ul style="list-style-type: none"> • The volume of the motor excitation sound is too high. • Hunting or oscillation at low speeds (10 Hz or lower), or at mid-range speeds (10 Hz to 40 Hz) 	C6-02 [Carrier Frequency Selection]	<ul style="list-style-type: none"> • If the volume of the motor excitation sound is too high, increase the carrier frequency. • If hunting or oscillation occur at low or mid-range speeds, decrease the carrier frequency. 	1 (2 kHz) *1	1 to upper limit value
<ul style="list-style-type: none"> • Unsatisfactory motor torque and speed response • Hunting or oscillation 	C4-02 [Torque Compensation Delay Time]	<ul style="list-style-type: none"> • If torque or speed response are slow, decrease the setting value. • If hunting or oscillation occur, increase the setting value. 	200 ms *2	100 ms to 1000 ms
<ul style="list-style-type: none"> • Torque at low speeds (10 Hz or lower) is not sufficient. • Hunting or oscillation 	C4-01 [Torque Compensation Gain]	<ul style="list-style-type: none"> • If torque at low speeds (10 Hz or lower) is not sufficient, increase the setting value. • If hunting or oscillation occur with light loads, decrease the setting value. 	1.00	0.50 - 1.50
<ul style="list-style-type: none"> • Torque at low speeds (10 Hz or lower) is not sufficient. • Large initial vibration at start up. 	<ul style="list-style-type: none"> • E1-08 [Mid Point A Voltage] • E1-10 [Minimum Output Voltage] 	<ul style="list-style-type: none"> • If torque at low speeds (10 Hz or lower) is not sufficient, increase the setting value. • If there is large initial vibration at start up, decrease the setting value 	<ul style="list-style-type: none"> • E1-08: 15.0 V *3 • E1-10: 9.0 V *3 	Default setting +/- 5 V *4
Speed precision is unsatisfactory. (V/f Control)	C3-01 [Slip Compensation Gain]	Set E2-01 [Motor Rated Current], E2-02 [Motor Rated Slip], and E2-03 [Motor No-Load Current], then adjust C3-01.	0.0 (no slip compensation)	0.5 - 1.5
Speed precision is unsatisfactory. (Closed Loop V/f Control)	<ul style="list-style-type: none"> • C5-01 [ASR Proportional Gain 1] • C5-02 [ASR Integral Time 1 (I)] *5 	Adjust C5-01, C5-02.	<ul style="list-style-type: none"> • C5-01: 0.20 • C5-02: 0.200 s 	<ul style="list-style-type: none"> • Proportional gain = 0.10 to 1.00 • Integral time = 0.100 to 2.000 s

*1 The default setting changes when the settings for C6-01 [Normal / Heavy Duty Selection] and o2-04 [Drive Model (KVA) Selection] change.

*2 The default setting changes when the settings for A1-02 [Control Method Selection] and o2-04 [Drive Model (KVA) Selection] change.

*3 The default setting changes when the settings for A1-02 [Control Method Selection] and E1-03 [V/f Pattern Selection] change.

- *4 Recommended settings are for 200 V class drives. Multiply the voltage by 2 for 400 V class drives.
- *5 In Closed Loop V/f Control, ASR only controls the output frequency. You cannot make a high-gain as in Closed Loop Vector control.

◆ Open Loop Vector Control Method

In Open Loop Vector Control, keep *C4-01 [Torque Compensation Gain]* at its default setting (1.00).

If you cannot get speed precision during regeneration in Open Loop Vector Control, set *C3-04 = 1 [Slip Compensation @ Regen Select = Enabled above 6 Hz]*.

Table 4.18 Parameters for Fine Tuning the Drive (A1-02 = 2[OLV])

Issue	Parameter Number	Possible Solutions	Default	Recommended Setting
<ul style="list-style-type: none"> • Unsatisfactory motor torque and speed response • Hunting or oscillation at mid-range speeds (10 Hz to 40 Hz) 	n2-01 [SpdFeedbackDetectCtr (AFR) Gain]	<ul style="list-style-type: none"> • To increase the speed of torque or speed response, decrease the setting value in increments of 0.05. • If hunting or oscillation occur, decrease the setting value in increments of 0.05. 	1.00	0.50 - 2.00
	n2-02 [SpdFeedbackDetCtr (AFR) TimeConst1]	<ul style="list-style-type: none"> • To increase the speed of torque or speed response, decrease the setting value in increments of 10 ms and examine the response. • If hunting or oscillation occur or if the load inertia is too much, increase the setting value in increments of 50 ms and examine the response. <p>Note: Make sure that this parameter setting is: $n2-02 \leq n2-03$ [Automatic Freq Regulator Time 2] holds true. When you adjust <i>n2-02</i>, you must also increase the <i>C4-02 [Motor 1 Torque Comp Delay Time]</i> value by the same ratio.</p>	50 ms	50 ms to 2000 ms
<i>ov [overvoltage]</i> occurs when the drive stops accelerating, starts to decelerate, or when there are large changes in the load.	n2-03 [SpdFeedbackDetCtr (AFR) TimeConst2]	<ul style="list-style-type: none"> • If <i>ov</i> occurs, increase the setting value in increments of 50 ms and examine the response. • If the response is not sufficient, decrease the setting value in increments of 10 ms and examine the response. <p>Note: Make sure that this parameter setting is: $n2-02$ [Automatic Freq Regulator Time 1] $\leq n2-03$. When you adjust <i>n2-03</i> you must also increase the <i>C4-06 [Motor 2 Torque Comp Delay Time]</i> value by the same ratio.</p>	750 ms	750 ms to 2000 ms
	C4-06 [Motor 2 Torque Comp Delay Time]	<ul style="list-style-type: none"> • If <i>ov</i> occurs, increase the setting value in increments of 10 ms and examine the response. • If the response is not sufficient, decrease the setting value in increments of 2 ms and examine the response. <p>Note: Make sure that this parameter setting is: $C4-02$ [Torque Compensation Delay Time] $\leq C4-06$. When you adjust <i>C4-06</i>, you must also increase the <i>n2-03 [SpdFeedbackDetCtr (AFR) TimeConst2]</i> value by the same ratio.</p>	150 ms	150 ms to 750 ms

4.10 Fine Tuning during Test Runs (Adjust the Control Function)

Issue	Parameter Number	Possible Solutions	Default	Recommended Setting
<ul style="list-style-type: none"> Unsatisfactory motor torque and speed response Hunting or oscillation 	C4-02 [Torque Compensation Delay Time 1]	<ul style="list-style-type: none"> If torque or speed response are slow, decrease the setting value in increments of 2 ms. If hunting or oscillation occur, increase the setting value in increments of 10 ms. <p>Note: Make sure that this parameter setting is: $C4-02 \leq C4-06$ [Motor 2 Torque Comp Delay Time].</p> <p>When you adjust C4-02, you must also increase the n2-02 [SpdFeedbackDetCtr (AFR) TimeConst1] value by the same ratio.</p>	20 ms ^{*1}	20 ms to 100 ms ^{*1}
<ul style="list-style-type: none"> Speed response is slow. Speed is not stable. 	C3-02 [Slip Compensation Delay Time]	<ul style="list-style-type: none"> If speed response is slow, decrease the setting value in increments of 10 ms. If speed is not stable, increase the value in increments of 10 ms. 	200 ms ^{*1}	100 ms to 500 ms
Speed precision is unsatisfactory.	C3-01 [Slip Compensation Gain]	<ul style="list-style-type: none"> If speed is too slow, increase the setting value in increments of 0.1. If speed is too fast, decrease the setting value in increments of 0.1. 	1.0 ^{*2}	0.5 - 1.5
<ul style="list-style-type: none"> The volume of the motor excitation sound is too high. Hunting or oscillation at low speeds (10 Hz or lower) 	C6-02 [Carrier Frequency Selection]	<ul style="list-style-type: none"> If the volume of the motor excitation sound is too high, increase the carrier frequency. If hunting or oscillation occur at low speeds, decrease the carrier frequency. 	1 (2 kHz) ^{*3}	0 to upper limit value
<ul style="list-style-type: none"> Torque at low speeds (10 Hz or lower) is not sufficient. speed response is slow. Speed response is slow. Large initial vibration at start up. 	<ul style="list-style-type: none"> E1-08 [Mid Point A Voltage] E1-10 [Minimum Output Voltage] 	<ul style="list-style-type: none"> If torque or speed response are slow, increase the setting value. If there is large initial vibration at start up, decrease the setting value <p>Note: If the setting value is set too high, a large torque reference may be output even with light loads.</p>	<ul style="list-style-type: none"> E1-08: 11.0 V ^{*2} E1-10: 2.0 V ^{*2} 	Default setting +/- 2 V ^{*4}

*1 The default setting changes when the settings for A1-02 [Control Method Selection] and o2-04 [Drive Model (KVA) Selection] change.

*2 The default setting changes when the settings for A1-02 [Control Method Selection] and E1-03 [V/f Pattern Selection] change.

*3 The default setting changes when the settings for C6-01 [Normal / Heavy Duty Selection] and o2-04 change.

*4 Recommended settings are for 200 V class drives. Multiply the voltage by 2 for 400 V class drives.

◆ Closed Loop Vector Control Method

Table 4.19 Parameters for Fine Tuning the Drive (CLV)

Issue	Parameter Number	Possible Solutions	Default	Recommended Setting
<ul style="list-style-type: none"> Unsatisfactory motor torque and speed response Hunting or oscillation 	<ul style="list-style-type: none"> High speed C5-01 [ASR Proportional Gain 1] Low speed C5-03 [ASR Proportional Gain 2 (P)] ^{*1} 	<ul style="list-style-type: none"> If torque or speed response are slow, increase the setting value in increments of 5.00. If hunting or oscillation occur, decrease the setting value. 	20.00	10.00 - 50.00
	<ul style="list-style-type: none"> High speed C5-02 [ASR Integral Time 1] Low speed C5-04 [ASR Integral Time 2 (I)] ^{*1} 	<ul style="list-style-type: none"> If torque or speed response are slow, decrease the setting value. If hunting or oscillation occur, increase the setting value. 	0.500 s	0.300 s to 1.000 s
The drive cannot find ASR proportional gain or integral time for low speed or high speed.	C5-07 [ASR Gain Switchover Frequency] ^{*1}	Change the ASR proportional gain and ASR integral time to conform to the output frequency.	0.0 Hz	0.0 Hz to maximum output frequency

4.10 Fine Tuning during Test Runs (Adjust the Control Function)

Issue	Parameter Number	Possible Solutions	Default	Recommended Setting
Hunting or oscillation	C5-06 [ASR Delay Time] ^{*1}	<ul style="list-style-type: none"> If torque or speed response are slow, decrease the setting value in increments of 0.010. If the rigidity of the machine is unsatisfactory and vibration is possible, increase the setting value. 	0.004 s	0.004 s to 0.020 s
<ul style="list-style-type: none"> The volume of the motor excitation sound is too high. Hunting or oscillation at low speeds (3 Hz or lower) 	C6-02 [Carrier Frequency Selection]	<ul style="list-style-type: none"> If the volume of the motor excitation sound is too high, increase the carrier frequency. If hunting or oscillation occur at low speeds, decrease the carrier frequency. 	1 (2.0 kHz) ^{*2}	2.0 kHz to upper limit value

*1 Refer to the section on *C5-xx parameters* for more information about speed control (ASR).

*2 The default setting changes when the settings for *C6-01 [Normal / Heavy Duty Selection]* and *o2-04 [Drive Model (KVA) Selection]* change.

◆ Advanced Open Loop Vector Control Method

Table 4.20 Parameters for Fine Tuning the Drive (AOLV)

Issue	Parameter Number	Possible Solutions	Default	Recommended Setting
<ul style="list-style-type: none"> <i>oS [Overspeed]</i> occurs. Hunting or oscillation. 	T1-01 [Auto-Tuning Mode Selection]	<ul style="list-style-type: none"> Make sure that the output of the drive and the motor are connected correctly. Do Rotational Auto-Tuning for a single motor. 	-	0
The volume of the motor excitation sound is too high.	C6-02 [Carrier Frequency Selection]	If the volume of the motor excitation sound is too high, increase the carrier frequency.	1 (2 kHz) ^{*1}	1 to upper limit value
Speed precision is unsatisfactory	E2-02 [Motor Rated Slip]	<ul style="list-style-type: none"> Decouple the motor and machine and do Rotational Auto-Tuning. If the motor speed is slow, increase the value of <i>E2-02</i> in small increments (approximately 0.1% of the default setting value). If the motor speed is fast, decrease the value of <i>E2-02</i> in small increments (approximately 0.1% of the default setting value). 	^{*2}	Set to a value that is $\pm 5\%$ of the current value.
<ul style="list-style-type: none"> Unsatisfactory motor torque and speed response Hunting or oscillation 	<ul style="list-style-type: none"> High speed C5-01 [ASR Proportional Gain 1] Low speed C5-03 [ASR Proportional Gain 2 (P)] ^{*3} 	<ul style="list-style-type: none"> If torque or speed response are slow, increase the setting value in increments of 5.00. If hunting or oscillation occur, decrease the setting value. 	<ul style="list-style-type: none"> C5-01 = 10.00 C5-03 = 20.00 	10.00 - 50.00
	<ul style="list-style-type: none"> High speed C5-02 [ASR Integral Time 1] Low speed C5-04 [ASR Proportional Gain 2 (P)] ^{*3} 	<ul style="list-style-type: none"> If torque or speed response are slow, decrease the setting value. If hunting or oscillation occur, increase the setting value. 	0.500 s	0.300 s to 1.000 s
The drive cannot find speed response for low speed or high speed.	<ul style="list-style-type: none"> C5-07 [ASR Gain Switchover Frequency] ^{*4} High speed C5-01 [ASR Proportional Gain 1] C5-02 [ASR Integral Time 1] Low speed C5-03 [ASR Proportional Gain 2 (P)] ^{*3} C5-04 [ASR Integral Time 2] 	Change the ASR proportional gain and ASR integral time to conform to the output frequency.	<ul style="list-style-type: none"> C5-07 = 0.0 Hz C5-01 = 10.00 C5-02 = 0.500 s C5-03 = 20.00 C5-04 = 0.500 s 	C5-07: 0.0 to maximum output frequency
Hunting or oscillation	C5-06 [ASR Delay Time] ^{*4}	<ul style="list-style-type: none"> If torque or speed response are slow, decrease the setting value in increments of 0.010. If the rigidity of the machine is unsatisfactory and vibration is possible, increase the setting value. 	0.004 s	0.004 s to 0.020 s

*1 The default setting changes when the settings for *C6-01 [Normal / Heavy Duty Selection]* and *o2-04 [Drive Model (KVA) Selection]* change.

*2 The default setting changes when the setting for *o2-04 [Drive Model Selection]* changes.

4.10 Fine Tuning during Test Runs (Adjust the Control Function)

- *3 Refer to the section on *C5-xx parameters* for more information about speed control (ASR).
 *4 The best values for a no-load operation are different than the best values for actual loading operation.

◆ Fine-Tuning Open Loop Vector Control for PM Motors

Table 4.21 Parameters for Fine Tuning the Drive (A1-02 = 5[OLV/PM])

Issue	Parameter Number	Possible Solutions	Default	Recommended Setting
Unsatisfactory motor performance	E1-xx parameters, E5-xx parameters	<ul style="list-style-type: none"> Check the settings for E1-06, E1-04 [Base Frequency, Maximum Output Frequency]. Check the E5-xx and make sure that all motor data has been set correctly. <p>Note: Do not set E5-05 [PM Motor Resistance (ohms/phase)] to a line-to-line resistance value.</p> <ul style="list-style-type: none"> Do Auto-Tuning. 	-	-
Unsatisfactory motor torque and speed response	n8-55 [Motor to Load Inertia Ratio]	Adjust to match the load inertia ratio of the motor and machine.	0	Near the actual load inertia ratio.
	n8-45 [Speed Feedback Detection Gain]	Decrease the setting value in increments of 0.05.	0.80	-
	C4-01 [Torque Compensation Gain]	Adjust the setting value. Note: Setting this value too high can cause overcompensation and motor oscillation.	0.00	1.00
<ul style="list-style-type: none"> Oscillation when the motor starts. Motor stalls. 	n8-51 [Pull-in Current @ Accel/Decel]	Increase the setting value in increments of 5%.	50%	-
	<ul style="list-style-type: none"> b2-02 [DC Injection Braking Current] b2-03 [DC Inject Braking Time at Start] 	Use DC Injection Braking at start. Note: This can cause the motor to rotate in reverse for approximately 1/8 of a turn at start.	<ul style="list-style-type: none"> b2-02: 50% b2-03: 0.00 s 	<ul style="list-style-type: none"> b2-02: Adjust as necessary. b2-03: 0.5 s
	n8-55 [Motor to Load Inertia Ratio]	Increase the setting value. Note: When operating a single motor or with a minimum amount of inertia, setting this value too high can cause motor oscillation.	0	Near the actual load inertia ratio.
There is too much current during deceleration.	n8-79 [Pull-in Current at Deceleration]	Set $n8-79 < n8-51$.	50% Note: When $n8-79 = 0$, the drive will apply the $n8-51$ setting to the pull-in current during deceleration.	Decrease in increments of 5%.
Stalling or oscillation occurs when load is applied during constant speed	n8-47 [Pull-in Current Comp Filter Time]	Decrease the setting value in increments of 0.2 s.	5.0 s	-
	n8-48 [Pull-in/Light Load Id Current]	Increase the setting value in increments of 5%.	30%	-
	n8-55 [Motor to Load Inertia Ratio]	Increase the setting value. Note: When operating a single motor or with a minimum amount of inertia, setting this value too high can cause motor oscillation.	0	Near the actual load inertia ratio.
Hunting or oscillation	n8-45 [Speed Feedback Detection Gain]	Increase the setting value in increments of 0.05.	0.80	-
The drive detects STPo [Motor Step-Out Detected] fault when the load is not too high.	<ul style="list-style-type: none"> E5-09 [PM Back-EMF Vpeak (mV/(rad/s))] E5-24 [PM Back-EMF L-L Vrms (mV/rpm)] 	<ul style="list-style-type: none"> Adjust the setting value. Examine the motor code on the motor nameplate or the data sheet, then set correct values for E5-09 or E5-24. 	*1	<ul style="list-style-type: none"> Yaskawa motor Set the motor code from the motor nameplate. Motor from another manufacturer Set the values from the test report.
The drive detected stalling or STPo [Motor Step-Out Detected] at high speed and maximum output voltage.	n8-62 [Output Voltage Limit Level]	Set to a value lower than the actual input voltage.	<ul style="list-style-type: none"> 200.0 V 400.0 V 	-

*1 The default setting changes when the settings for E5-01 [Motor Code Selection] and o2-04 [Drive Model (KVA) Selection] change.

◆ **Advanced Open Loop Vector Control Method for PM**

Table 4.22 Parameters for Fine Tuning the Drive (A1-02 = 6[AOLV/PM])

Issue	Parameter Number	Possible Solutions	Default	Recommended Setting
<ul style="list-style-type: none"> Unsatisfactory motor torque and speed response Hunting or oscillation 	<ul style="list-style-type: none"> High speed C5-01 [ASR Proportional Gain 1] Low speed C5-03 [ASR Proportional Gain 2] 	<ul style="list-style-type: none"> If torque or speed response are slow, increase the setting value in increments of 5.00. If hunting or oscillation occur, decrease the setting value. 	10.00	5.00 to 30.00 ^{*1}
	<ul style="list-style-type: none"> High speed C5-02 [ASR Integral Time 1] Low speed C5-04 [ASR Integral Time 2] 	<ul style="list-style-type: none"> If torque or speed response are slow, decrease the setting value. If hunting or oscillation occur, increase the setting value. 	0.500 s	0.300 s to 1.000 s ^{*1}
The drive cannot find ASR proportional gain or integral time for low speed or high speed.	C5-07 [ASR Gain Switchover Frequency]	Change the ASR proportional gain and ASR integral time to conform to the output frequency.	0.0%	0.0% to maximum rotation speed
Hunting or oscillation	C5-06 [ASR Delay Time]	If the rigidity of the machine is unsatisfactory and vibration is possible, increase the setting value in increments of 0.010.	0.016 s	0.016 s to 0.035 s ^{*1}
Step-out	E1-xx parameters, E5-xx parameters	Refer to the motor nameplate or test report and set E1-xx or E5-xx correctly.	-	-

*1 The best values for a no-load operation are different than the best values for actual loading operation.

◆ **Closed Loop Vector Control Method for PM**

Table 4.23 Parameters for Fine Tuning the Drive (CLV/PM)

Issue	Parameter Number	Possible Solutions	Default	Recommended Setting
<ul style="list-style-type: none"> Unsatisfactory motor torque and speed response Hunting or oscillation 	<ul style="list-style-type: none"> High speed C5-01 [ASR Proportional Gain 1] Low speed C5-03 [ASR Proportional Gain 2] 	<ul style="list-style-type: none"> If torque or speed response are slow, increase the setting value in increments of 5.00. If hunting or oscillation occur, decrease the setting value. 	20.00	10.00 to 50.00 ^{*1}
	<ul style="list-style-type: none"> High speed C5-02 [ASR Integral Time 1] Low speed C5-04 [ASR Integral Time 2] 	<ul style="list-style-type: none"> If torque or speed response are slow, decrease the setting value. If hunting or oscillation occur, increase the setting value. 	0.500 s	0.300 to 1.000 s ^{*1}
The drive cannot find speed response for low speed or high speed.	<ul style="list-style-type: none"> C5-07 [ASR Gain Switchover Frequency] High speed C5-01 [ASR Proportional Gain 1] C5-02 [ASR Integral Time 1] Low speed C5-03 [ASR Proportional Gain 2] C5-04 [ASR Integral Time 2] 	Change the ASR proportional gain and ASR integral time to conform to the output frequency.	<ul style="list-style-type: none"> C5-07 = 0.0 % C5-01 = 20.00 C5-02 = 0.500 s C5-03 = 20.00 C5-04 = 0.500 s 	0.0% to maximum rotation speed
Hunting or oscillation	C5-06 [ASR Delay Time]	If the rigidity of the machine is unsatisfactory and vibration is possible, increase the setting value in increments of 0.010.	0.004 s	0.004 to 0.020 s ^{*1}
Step-out	E1-xx parameters, E5-xx parameters	Refer to the motor nameplate or test report and set E1-xx or E5-xx correctly.	-	-

*1 The best values for a no-load operation are different than the best values for actual loading operation.

◆ EZ Open Loop Vector Control Method

Table 4.24 Parameters for Fine Tuning the Drive (A1-02 = 8[EZOLV])

Issue	Parameter Number	Possible Solutions	Default	Recommended Setting
<ul style="list-style-type: none"> Unsatisfactory motor torque and speed response Hunting or oscillation 	<ul style="list-style-type: none"> High speed C5-01 [ASR Proportional Gain 1] Low speed C5-03 [ASR Proportional Gain 2] 	<ul style="list-style-type: none"> If torque or speed response are slow, increase the setting value in increments of 5.00. If hunting or oscillation occur, decrease the setting value. 	10.00	10.00 to 50.00 <i>*1</i>
	<ul style="list-style-type: none"> High speed C5-02 [ASR Integral Time 1] Low speed C5-04 [ASR Integral Time 2] 	<ul style="list-style-type: none"> If torque or speed response are slow, decrease the setting value. If hunting or oscillation occur, increase the setting value. 	0.500 s	0.300 s to 1.000 s <i>*1</i>
The drive cannot find ASR proportional gain or integral time for low speed or high speed.	C5-07 [ASR Gain Switchover Frequency]	Change the ASR proportional gain and ASR integral time to conform to the output frequency.	0.0%	0.0% to maximum rotation speed
Hunting or oscillation	C5-06 [ASR Delay Time]	If the rigidity of the machine is unsatisfactory and vibration is possible, increase the setting value in increments of 0.010.	0.004 s	0.004 s to 0.020 s <i>*1</i>
Step-out	E9-xx parameters	Refer to the motor nameplate or test report and set E9-xx correctly.	-	-
Oscillation when the motor starts.	n8-51 [Accel / Decel Pull-In Current]	Increase the setting value.	80%	Increase in increments of 5%.
Motor stalls.	L7-01 to L7-04 [Torque Limit]	Increase the setting value.	200%	Increase in increments of 10%.

*1 The best values for a no-load operation are different than the best values for actual loading operation.

4.11 Test Run Checklist

Examine the items in this checklist and check each item before a test run.

Checked	No.	Description
	1	Correctly install and wire the drive as specified by this manual.
	2	Energize the drive.
	3	Set the voltage for the power supply in E1-01 [Input AC Supply Voltage].

Check the applicable items as specified by your control method.

WARNING! Sudden Movement Hazard. Correctly wire the start/stop and safety circuits before you energize the drive. If you momentarily close a digital input terminal, it can start a drive that is programmed for 3-Wire control and cause serious injury or death from moving equipment.

Table 4.25 V/f Control [A1-02 = 0] and Closed Loop V/f Control [A1-02 = 1]

Checked	No.	Description
	4	Select the best V/f pattern for your application and motor characteristics. Example: For a motor with a rated frequency of 60 Hz, set E1-03 = 1 [V/f Pattern Selection = Const Trq, 60Hz base, 60Hz max] as a standard V/f pattern.

Table 4.26 Closed Loop V/f Control [A1-02 = 1]

Checked	No.	Description
	5	Set F1-01 [Encoder 1 Pulse Count (PPR)] correctly and make sure that encoder pulse counting direction is correct.
	6	Set C5-01 [ASR Proportional Gain 1] and C5-02 [ASR Integral Time 1].

Table 4.27 Open Loop Vector Control [A1-02 = 2] or Closed Loop Vector Control [A1-02 = 3]

Checked	No.	Description
	7	Decouple motor shafts and machines.
	8	Refer to the information on the motor nameplate and set this data correctly: <ul style="list-style-type: none"> • Motor rated power (kW) to T1-02 • Motor rated voltage (V) to T1-03 • Motor rated current (A) to T1-04 • Motor base frequency (Hz) to T1-05 • Number of motor poles to T1-06 • Motor base speed (min⁻¹) to T1-07
	9	Do Rotational Auto-Tuning.

Table 4.28 Closed Loop Vector Control [A1-02 = 3]

Checked	No.	Description
	10	Set F1-01 [Encoder 1 Pulse Count (PPR)] and F1-05 [Encoder 1 Rotation Selection].
	11	Set C5-01 [ASR Proportional Gain 1] and C5-02 [ASR Integral Time 1].

Table 4.29 PM Open Loop Vector Control [A1-02 = 5]

Checked	No.	Description
	12	Set E5-01 through E5-24 [PM Motor Settings].

Table 4.30 PM Advanced Open Loop Vector [A1-02 = 6]

Checked	No.	Description
	13	Set E5-01 through E5-24 [PM Motor Settings].
	14	Set C5-01 [ASR Proportional Gain 1] and C5-02 [ASR Integral Time 1].

Table 4.31 PM Closed Loop Vector Control [A1-02 = 7]

Checked	No.	Description
	15	Set E5-01 through E5-24 [PM Motor Settings].
	16	Set C5-01 [ASR Proportional Gain 1] and C5-02 [ASR Integral Time 1].

4.11 Test Run Checklist

Checked	No.	Description
	17	Set F1-01 [Encoder 1 Pulse Count (PPR)] and F1-05 [Encoder 1 Rotation Selection].
	18	Set E5-11 [Encoder Z-Pulse Offset].
Checked	No.	Description
	19	The keypad will show "Rdy" after starting to operate the motor.
	20	To give the Run command and frequency reference from the keypad, push LO/RE to set to LOCAL Mode (when in LOCAL Mode, the LO/RE LED illuminates).
	21	If the motor rotates in the opposite direction during test run, switch two of the motor cables (U/T1, V/T2, W/T3).
	22	Set Heavy Duty or Normal Duty Mode with C6-01 [Normal / Heavy Duty Selection] to conform to the load condition.
	23	Set E2-01 [Motor Rated Current (FLA)] and L1-01 [Motor Overload Protection Select] correctly for motor thermal protection.
	24	Set the drive for REMOTE Mode when the control circuit terminals supply the Run command and frequency reference (in REMOTE Mode, the LO/RE LED turns OFF).
	25	<p>When terminal A1 is used for the frequency reference:</p> <ul style="list-style-type: none"> • Voltage input <ul style="list-style-type: none"> – Set DIP Switch S1-1 on the drive to "V". – Set H3-01 = 0, 1 [Terminal A1 Signal Level Select = 0 to 10V (Lower Limit at 0), -10 to +10V (Bipolar Reference)]. – Set H3-02 = 0 [Terminal A1 Function Selection = Frequency Reference]. • Current input <ul style="list-style-type: none"> – Set DIP Switch S1-1 on the drive to "I". – Set H3-01 = 2, 3 [Terminal A1 Signal Level Select = 4 to 20 mA, 0 to 20 mA]. – Set H3-02 = 0 [Terminal A1 Function Selection = Frequency Reference].
	26	<p>When terminal A2 is used for the frequency reference:</p> <ul style="list-style-type: none"> • Voltage input <ul style="list-style-type: none"> – Set DIP Switch S1-2 on the drive to "V". – Set H3-09 = 0, 1 [Terminal A2 Signal Level Select = 0 to 10V (Lower Limit at 0), -10 to 10 V (Bipolar Reference)]. – Set H3-10 = 0 [Terminal A2 Function Selection = Frequency Reference]. • Current input <ul style="list-style-type: none"> – Set DIP Switch S1-2 on the drive to "I". – Set H3-09 = 2, 3 [Terminal A2 Signal Level Select = 4 to 20 mA, 0 to 20 mA]. – Set H3-10 = 0 [Terminal A2 Function Selection = Frequency Reference].
	27	<p>When terminal A3 is used for the frequency reference:</p> <ul style="list-style-type: none"> • Voltage input <ul style="list-style-type: none"> – Set DIP Switch S4 on the drive to analog input side. – Set DIP Switch S1-3 on the drive to "V". – Set H3-05 = 0, 1 [Terminal A3 Signal Level Select = 0 to 10V (Lower Limit at 0), -10 to +10V (Bipolar Reference)]. – Set H3-06 = 0 [Terminal A3 Function Selection = Frequency Reference]. • Current input <ul style="list-style-type: none"> – Set DIP Switch S4 on the drive to analog input side. – Set DIP Switch S1-3 on the drive to "I". – Set H3-05 = 2, 3 [Terminal A3 Signal Level Select = 4 to 20 mA (Lower Limit at 4), 0 to 20 mA (Bipolar Reference)]. – Set H3-06 = 0 [Terminal A3 Function Selection = Frequency Reference].
	28	<p>Make sure that the frequency reference reaches the necessary minimum and maximum values. → If drive operation is incorrect, make these adjustments:</p> <p>Gain adjustment: Set the maximum voltage and current values, then adjust the analog input gain until the frequency reference reaches the necessary value. (For terminal A1 input: H3-03, for terminal A2 input: H3-11, for terminal A3 input: H3-07)</p> <p>Bias adjustment: Set the maximum voltage/current values, then adjust the analog input bias until the frequency reference reaches the necessary minimum value. (For terminal A1 input: H3-04, for terminal A2 input: H3-12, for terminal A3 input: H3-08)</p>

Standards Compliance

This chapter gives information about how to make the machines and devices that use this product comply with European standards and UL standards.

5.1	Section Safety	212
5.2	European Standards.....	214
5.3	UL Standards.....	235
5.4	对应中国RoHS指令.....	259
5.5	China RoHS Compliance.....	260
5.6	Safe Disable Input.....	261

5.1 Section Safety

DANGER

Electrical Shock Hazard

Do not examine, connect, or disconnect wiring on an energized drive. Before servicing, disconnect all power to the equipment and wait for the time specified on the warning label at a minimum. The internal capacitor stays charged after the drive is de-energized. The charge indicator LED extinguishes when the DC bus voltage decreases below 50 Vdc. When all indicators are OFF, remove the covers before measuring for dangerous voltages to make sure that the drive is safe.

If you do work on the drive when it is energized, it will cause serious injury or death from electrical shock. The drive has internal capacitors that stay charged after you de-energize the drive.

WARNING

Electrical Shock Hazard

Do not operate the drive when covers are missing. Replace covers and shields before you operate the drive. Use the drive only as specified by the instructions.

Some figures in this section include drives without covers or safety shields to more clearly show the inside of the drive. If covers or safety shields are missing from the drive, it can cause serious injury or death.

Always ground the motor-side grounding terminal.

If you do not ground the equipment correctly, it can cause serious injury or death if you touch the motor case.

Do not remove covers or touch circuit boards while the drive is energized.

If you touch the internal components of an energized drive, it can cause serious injury or death.

Only let approved personnel install, wire, maintain, examine, replace parts, and repair the drive.

If personnel are not approved, it can cause serious injury or death.

Do not wear loose clothing or jewelry when you do work on the drive. Tighten loose clothing and remove all metal objects, for example watches or rings.

Loose clothing can catch on the drive and jewelry can conduct electricity and cause serious injury or death.

Do not modify the drive body or drive circuitry.

Modifications to drive body and circuitry can cause serious injury or death, will cause damage to the drive, and will void the warranty. Yaskawa is not responsible for modifications of the product made by the user.

Fire Hazard

Tighten all terminal screws to the correct tightening torque.

Connections that are too loose or too tight can cause incorrect operation and damage to the drive. Incorrect connections can also cause death or serious injury from fire.

Tighten screws at an angle in the specified range shown in this manual.

If you tighten the screws at an angle not in the specified range, you can have loose connections that can cause damage to the terminal block or start a fire and cause serious injury or death.

Damage to Equipment

Do not apply incorrect voltage to the main circuit of the drive. Operate the drive in the specified range of the input voltage on the drive nameplate.

Voltages that are higher than the permitted nameplate tolerance can cause damage to the drive.

Fire Hazard

Do not put flammable or combustible materials on top of the drive and do not install the drive near flammable or combustible materials. Attach the drive to metal or other noncombustible material.

Flammable and combustible materials can start a fire and cause serious injury or death.

⚠ WARNING**Crush Hazard**

Wear eye protection when you do work on the drive.

If you do not use correct safety equipment, it can cause serious injury or death.

Electrical Shock Hazard

After the drive blows a fuse or trips a GFCI, do not immediately energize the drive or operate peripheral devices. Wait for the time specified on the warning label at a minimum and make sure that all indicators are OFF. Then check the wiring and peripheral device ratings to find the cause of the problem. If you do not know the cause of the problem, contact Yaskawa before you energize the drive or peripheral devices.

If you do not fix the problem before you operate the drive or peripheral devices, it can cause serious injury or death.

NOTICE**Damage to Equipment**

When you touch the drive and circuit boards, make sure that you observe correct electrostatic discharge (ESD) procedures.

If you do not follow procedures, it can cause ESD damage to the drive circuitry.

Do not break the electrical connection between the drive and the motor when the drive is outputting voltage.

Incorrect equipment sequencing can cause damage to the drive.

Before you connect a dynamic braking option to the drive, make sure that qualified personnel read and obey the Braking Unit and Braking Resistor Unit Installation Manual (TOBPC72060001).

If you do not read and obey the manual or if personnel are not qualified, it can cause damage to the drive and braking circuit.

Make sure that all connections are correct after you install the drive and connect peripheral devices.

Incorrect connections can cause damage to the drive.

Note:

Do not use unshielded cable for control wiring. Use shielded, twisted-pair wires and ground the shield to the ground terminal of the drive. Unshielded wire can cause electrical interference and unsatisfactory system performance.

5.2 European Standards



Figure 5.1 CE Mark

The CE Mark identifies that the product meets environmental and safety standards in the European Union. Products manufactured, sold, or imported in the European Union must display the CE Mark.

European Union standards include standards for electrical appliances (Low Voltage Directive), standards for electrical noise (EMC Directive), and standards for machinery (Machinery Directive).

This product displays the CE Mark in accordance with the Low Voltage Directive, the EMC Directive, and the Machinery Directive.

Table 5.1 Harmonized Standard

European Directive	Harmonized Standard
CE Low Voltage Directive Compliance 2014/35/EU	IEC/EN 61800-5-1:2007
EMC Directive 2014/30/EU	EN 61800-3: 2004+A1:2012
Machinery Directive 2006/42/EC	<ul style="list-style-type: none"> • EN ISO 13849-1:2015 (PL e (Cat.III)) • IEC 62061(ed.1);am1;am2 (SILCL3) • EN 62061:2005/A2:2015 (SILCL3) • IEC/EN 61800-5-2:2016

The customer must display the CE Mark on the final device containing this product. Customers must verify that the final device complies with EU standards.

◆ EU Declaration of Conformity

Go to www.yaskawa.com and search for "EU Declaration of Conformity" to get an original copy of the EU Declaration of Conformity.

Yaskawa declares that this product complies with the following directives and standards at our sole responsibility.

◆ CE Low Voltage Directive Compliance

It has been confirmed that this product complies with the CE Low Voltage Directive by conducting a test according to IEC/EN 61800-5-1:2007.

The following conditions must be satisfied for machines and devices incorporating this product to comply with the CE Low Voltage Directive.

■ Area of Use

Install this product in a location with Overvoltage Category III and pollution degree 2 or less as specified in IEC/CE 60664.

■ Guarding Against Debris

When you install IP20/UL Open Type drives (model: 2xxxxB, 4xxxxB), use an enclosure that does not let unwanted material enter the drive from above or below.

■ Electrical Installation

Refer to [Figure 5.2](#) for an example of a drive that is wired to comply with the CE Low Voltage Directive.

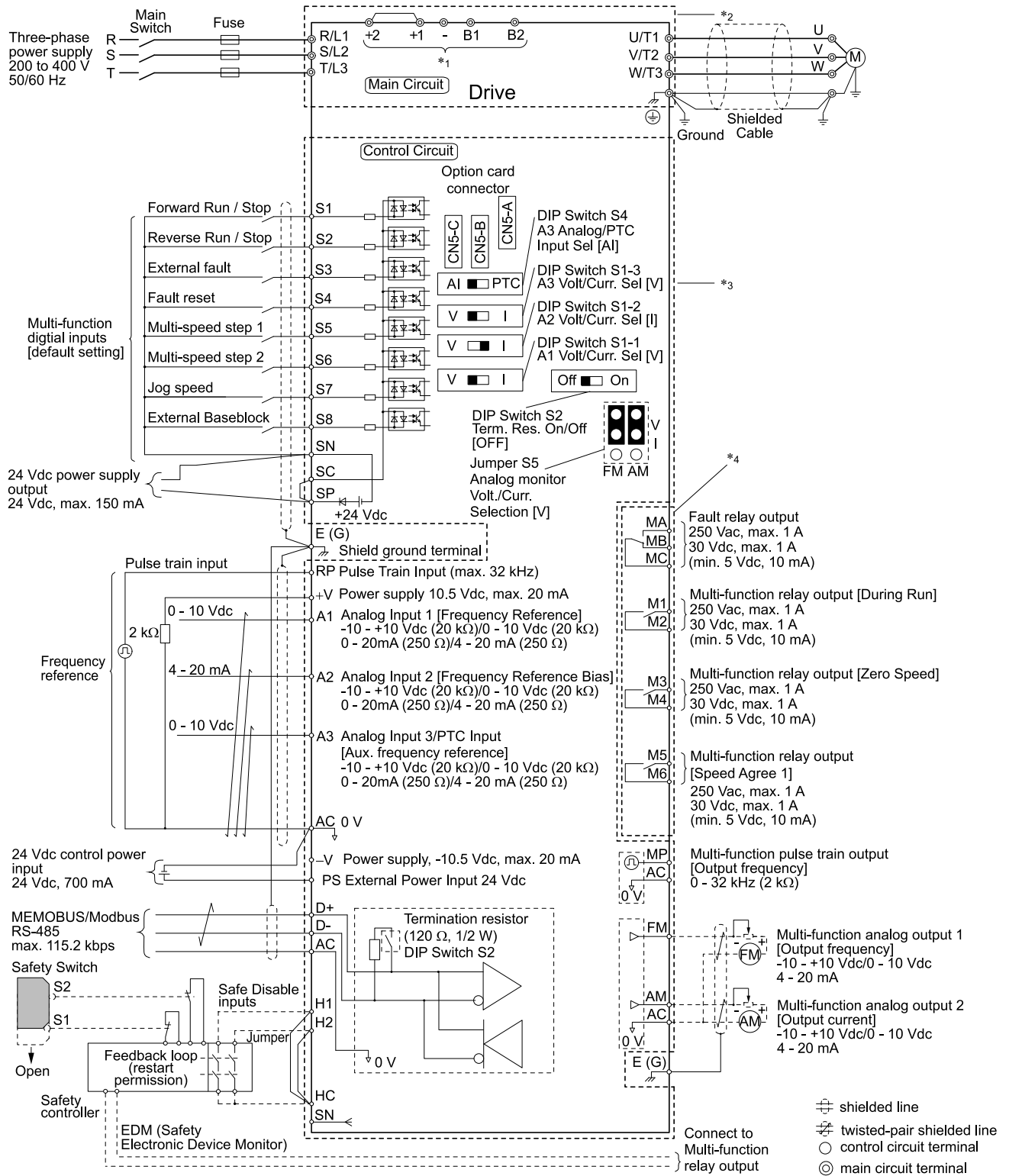

Figure 5.2 Wiring Diagram for CE Low Voltage Directive Compliance

*1 Use terminals -, +1, +2, B1, and B2 to connect options to the drive.

WARNING! Sudden Movement Hazard. Make sure that the polarity is correct before you send a Run command. If the drive incorrectly detects the polarity, the drive can rotate in the direction opposite of the Run command and cause serious injury or death.

*2 For circuit protection, the main circuit is separated from the surface case that can touch the main circuit.

*3 The control circuit is a Safety Extra-Low Voltage circuit. Separate this circuit from other circuits with reinforced insulation. Make sure that the Safety Extra-Low Voltage circuit is connected as specified.

5.2 European Standards

*4 Reinforced insulation separates the output terminals from other circuits. Users can also connect circuits that are not Safety Extra-Low Voltage circuits if the drive output is 250 Vac 1 A maximum or 30 Vdc 1 A maximum.

■ Main Circuit Wire Gauges and Tightening Torques

WARNING! Electrical Shock Hazard. Only connect peripheral options, for example a DC link choke or braking resistor, to terminals +1, +2, +3, -, B1, and B2. Incorrect wiring can cause serious injury or death.

Note:

- The recommended wire gauges are based on drive continuous current ratings with 75 °C (167 °F) 600 V class 2 heat-resistant indoor PVC wire. Assume these conditions:
 - Ambient temperature: 40 °C (104 °F) maximum
 - Wiring distance: 100 m (328 ft) maximum
 - Normal Duty rated current value
- Refer to the instruction manual for each device for recommended wire gauges to connect peripheral devices or options to terminals +1, +2, +3, -, B1, and B2. Contact Yaskawa or your nearest sales representative if the recommended wire gauges for the peripheral devices or options are out of the range of the applicable gauges for the drive.

Three-Phase 200 V Class

Model	Terminals	Recommended Gauge mm ²	Applicable Gauge (IP20 Applicable Gauge ^{*1}) mm ²	Wire Stripping Length ^{*2} mm	Terminal Screw		Tightening Torque N·m (in·lb)
					Size	Shape	
2004	R/L1, S/L2, T/L3	2.5	2.5 - 10 (2.5 - 10)	10	M4	Slotted (-)	1.5 - 1.7 (13.5 - 15)
	U/T1, V/T2, W/T3	2.5	2.5 - 10 (2.5 - 10)	10	M4	Slotted (-)	1.5 - 1.7 (13.5 - 15)
	-, +1, +2	2.5	2.5 - 16 (2.5 - 16)	18	M5	Slotted (-)	2.3 - 2.5 (19.8 - 22) ^{*3}
	B1, B2	2.5	2.5 - 4 (2.5 - 4)	10	M4	Slotted (-)	1.5 - 1.7 (13.5 - 15)
	⊕	2.5 ^{*4}	2.5 - 10 (-)	-	M4	Phillips/slotted combo	1.2 - 1.5 (10.6 - 13.3)
2006	R/L1, S/L2, T/L3	2.5	2.5 - 10 (2.5 - 10)	10	M4	Slotted (-)	1.5 - 1.7 (13.5 - 15)
	U/T1, V/T2, W/T3	2.5	2.5 - 10 (2.5 - 10)	10	M4	Slotted (-)	1.5 - 1.7 (13.5 - 15)
	-, +1, +2	2.5	2.5 - 16 (2.5 - 16)	18	M5	Slotted (-)	2.3 - 2.5 (19.8 - 22) ^{*3}
	B1, B2	2.5	2.5 - 4 (2.5 - 4)	10	M4	Slotted (-)	1.5 - 1.7 (13.5 - 15)
	⊕	2.5 ^{*4}	2.5 - 10 (-)	-	M4	Phillips/slotted combo	1.2 - 1.5 (10.6 - 13.3)
2008	R/L1, S/L2, T/L3	2.5	2.5 - 10 (2.5 - 10)	10	M4	Slotted (-)	1.5 - 1.7 (13.5 - 15)
	U/T1, V/T2, W/T3	2.5	2.5 - 10 (2.5 - 10)	10	M4	Slotted (-)	1.5 - 1.7 (13.5 - 15)
	-, +1, +2	2.5	2.5 - 16 (2.5 - 16)	18	M5	Slotted (-)	2.3 - 2.5 (19.8 - 22) ^{*3}
	B1, B2	2.5	2.5 - 4 (2.5 - 4)	10	M4	Slotted (-)	1.5 - 1.7 (13.5 - 15)
	⊕	2.5 ^{*4}	2.5 - 10 (-)	-	M4	Phillips/slotted combo	1.2 - 1.5 (10.6 - 13.3)

Model	Terminals	Recommended Gauge mm ²	Applicable Gauge (IP20 Applicable Gauge ^{*1}) mm ²	Wire Stripping Length ^{*2} mm	Terminal Screw		Tightening Torque N-m (in-lb)
					Size	Shape	
2010	R/L1, S/L2, T/L3	2.5	2.5 - 10 (2.5 - 10)	10	M4	Slotted (-)	1.5 - 1.7 (13.5 - 15)
	U/T1, V/T2, W/T3	2.5	2.5 - 10 (2.5 - 10)	10	M4	Slotted (-)	1.5 - 1.7 (13.5 - 15)
	-, +1, +2	2.5	2.5 - 16 (2.5 - 16)	18	M5	Slotted (-)	2.3 - 2.5 (19.8 - 22) ^{*3}
	B1, B2	2.5	2.5 - 4 (2.5 - 4)	10	M4	Slotted (-)	1.5 - 1.7 (13.5 - 15)
	⊕	2.5 ^{*4}	2.5 - 10 (-)	-	M4	Phillips/slotted combo	1.2 - 1.5 (10.6 - 13.3)
2012	R/L1, S/L2, T/L3	2.5	2.5 - 10 (2.5 - 10)	10	M4	Slotted (-)	1.5 - 1.7 (13.5 - 15)
	U/T1, V/T2, W/T3	2.5	2.5 - 10 (2.5 - 10)	10	M4	Slotted (-)	1.5 - 1.7 (13.5 - 15)
	-, +1, +2	2.5	2.5 - 16 (2.5 - 16)	18	M5	Slotted (-)	2.3 - 2.5 (19.8 - 22) ^{*3}
	B1, B2	2.5	2.5 - 4 (2.5 - 4)	10	M4	Slotted (-)	1.5 - 1.7 (13.5 - 15)
	⊕	2.5 ^{*4}	2.5 - 10 (-)	-	M4	Phillips/slotted combo	1.2 - 1.5 (10.6 - 13.3)
2018	R/L1, S/L2, T/L3	2.5	2.5 - 10 (2.5 - 10)	10	M4	Slotted (-)	1.5 - 1.7 (13.5 - 15)
	U/T1, V/T2, W/T3	2.5	2.5 - 10 (2.5 - 10)	10	M4	Slotted (-)	1.5 - 1.7 (13.5 - 15)
	-, +1, +2	4	2.5 - 16 (2.5 - 16)	18	M5	Slotted (-)	2.3 - 2.5 (19.8 - 22) ^{*3}
	B1, B2	2.5	2.5 - 4 (2.5 - 4)	10	M4	Slotted (-)	1.5 - 1.7 (13.5 - 15)
	⊕	2.5 ^{*4}	2.5 - 10 (-)	-	M4	Phillips/slotted combo	1.2 - 1.5 (10.6 - 13.3)
2021	R/L1, S/L2, T/L3	6	2.5 - 10 (2.5 - 10)	10	M4	Slotted (-)	1.5 - 1.7 (13.5 - 15)
	U/T1, V/T2, W/T3	2.5	2.5 - 10 (2.5 - 10)	10	M4	Slotted (-)	1.5 - 1.7 (13.5 - 15)
	-, +1, +2	6	2.5 - 16 (2.5 - 16)	18	M5	Slotted (-)	2.3 - 2.5 (19.8 - 22) ^{*3}
	B1, B2	2.5	2.5 - 4 (2.5 - 4)	10	M4	Slotted (-)	1.5 - 1.7 (13.5 - 15)
	⊕	6 ^{*4}	4 - 10 (-)	-	M4	Phillips/slotted combo	1.2 - 1.5 (10.6 - 13.3)
2030	R/L1, S/L2, T/L3	10	2.5 - 10 (2.5 - 10)	10	M4	Slotted (-)	1.5 - 1.7 (13.5 - 15)
	U/T1, V/T2, W/T3	6	2.5 - 10 (2.5 - 10)	10	M4	Slotted (-)	1.5 - 1.7 (13.5 - 15)
	-, +1, +2	10	2.5 - 16 (2.5 - 16)	18	M5	Slotted (-)	2.3 - 2.5 (19.8 - 22) ^{*3}
	B1, B2	2.5	2.5 - 4 (2.5 - 4)	10	M4	Slotted (-)	1.5 - 1.7 (13.5 - 15)
	⊕	10	6 - 10 (-)	-	M5	Phillips/slotted combo	2.0 - 2.5 (17.7 - 22.1)

5.2 European Standards

Model	Terminals	Recommended Gauge mm ²	Applicable Gauge (IP20 Applicable Gauge ^{*1}) mm ²	Wire Stripping Length ^{*2} mm	Terminal Screw		Tightening Torque N·m (in·lb)
					Size	Shape	
2042	R/L1, S/L2, T/L3	10	2.5 - 10 (2.5 - 10)	10	M4	Slotted (-)	1.5 - 1.7 (13.5 - 15)
	U/T1, V/T2, W/T3	10	2.5 - 10 (2.5 - 10)	10	M4	Slotted (-)	1.5 - 1.7 (13.5 - 15)
	-, +1, +2	16	2.5 - 16 (2.5 - 16)	18	M5	Slotted (-)	2.3 - 2.5 (19.8 - 22) ^{*3}
	B1, B2	4	2.5 - 4 (2.5 - 4)	10	M4	Slotted (-)	1.5 - 1.7 (13.5 - 15)
	⊕	10	6 - 10 (-)	-	M5	Phillips/slotted combo	2.0 - 2.5 (17.7 - 22.1)
2056	R/L1, S/L2, T/L3	25	2.5 - 25 (10 - 25)	18	M5	Slotted (-)	2.3 - 2.5 (19.8 - 22) ^{*3}
	U/T1, V/T2, W/T3	16	2.5 - 16 (6 - 16)	18	M5	Slotted (-)	2.3 - 2.5 (19.8 - 22) ^{*3}
	-, +1, +2	35	2.5 - 35 (10 - 35)	20	M6	Hex socket cap (WAF: 5 mm)	5 - 5.5 (45 - 49)
	B1, B2	10	2.5 - 10 (2.5 - 10)	10	M4	Slotted (-)	1.5 - 1.7 (13.5 - 15)
	⊕	16	10 - 16 (-)	-	M6	Phillips/slotted combo	5.4 - 6.0 (47.8 - 53.1)
2070	R/L1, S/L2, T/L3	35	2.5 - 35 (25 - 35)	20	M6	Hex socket cap (WAF: 5 mm)	5 - 5.5 (45 - 49)
	U/T1, V/T2, W/T3	16	2.5 - 16 (16)	20	M6	Hex socket cap (WAF: 5 mm)	5 - 5.5 (45 - 49)
	-, +1, +2	50	2.5 - 50 (35 - 50)	20	M6	Hex socket cap (WAF: 5 mm)	5 - 5.5 (45 - 49)
	B1, B2	10	2.5 - 10 (2.5 - 10)	10	M4	Slotted (-)	1.5 - 1.7 (13.5 - 15)
	⊕	16	16 - 25 (-)	-	M6	Phillips/slotted combo	5.4 - 6.0 (47.8 - 53.1)
2082	R/L1, S/L2, T/L3	35	2.5 - 35 (25 - 35)	20	M6	Hex socket cap (WAF: 5 mm)	5 - 5.5 (45 - 49)
	U/T1, V/T2, W/T3	25	2.5 - 25 (16 - 25)	20	M6	Hex socket cap (WAF: 5 mm)	5 - 5.5 (45 - 49)
	-, +1, +2	50	2.5 - 50 (35 - 50)	20	M6	Hex socket cap (WAF: 5 mm)	5 - 5.5 (45 - 49)
	B1, B2	16	2.5 - 16 (2.5 - 16)	10	M4	Slotted (-)	1.5 - 1.7 (13.5 - 15)
	⊕	16	16 - 25 (-)	-	M6	Phillips/slotted combo	5.4 - 6.0 (47.8 - 53.1)
2110	R/L1, S/L2, T/L3	35	16 - 35 (25 - 35)	27	M6	Hex socket cap (WAF: 5 mm)	8 - 9 (71 - 80)
	U/T1, V/T2, W/T3	35	16 - 35 (25 - 35)	27	M6	Hex socket cap (WAF: 5 mm)	8 - 9 (71 - 80)
	-, +1	50	25 - 50 (25 - 50)	27	M8	Hex socket cap (WAF: 6 mm)	10 - 12 (89 - 107)
	B1, B2	25	6 - 25 (6 - 25)	21	M6	Slotted (-)	3 - 3.5 (27 - 31)
	⊕	16	16 - 25 (-)	-	M6	Hex bolt (+)	5.4 - 6.0 (47.8 - 53.1)

Model	Terminals	Recommended Gauge mm ²	Applicable Gauge (IP20 Applicable Gauge ^{*1}) mm ²	Wire Stripping Length ^{*2} mm	Terminal Screw		Tightening Torque N-m (in-lb)
					Size	Shape	
2138	R/L1, S/L2, T/L3	50	16 - 50 (50)	27	M6	Hex socket cap (WAF: 5 mm)	8 - 9 (71 - 80)
	U/T1, V/T2, W/T3	50	16 - 50 (50)	27	M6	Hex socket cap (WAF: 5 mm)	8 - 9 (71 - 80)
	-, +1	70	25 - 70 (50 - 70)	27	M8	Hex socket cap (WAF: 6 mm)	10 - 12 (89 - 107)
	B1, B2	35	6 - 35 (6 - 35)	21	M6	Slotted (-)	3 - 3.5 (27 - 31)
	⊕	25	25 (-)	-	M6	Hex bolt (+)	5.4 - 6.0 (47.8 - 53.1)
2169	R/L1, S/L2, T/L3	70	50 - 95 (95)	37	M10	Hex socket cap (WAF: 8 mm)	12 - 14 (107 - 124)
	U/T1, V/T2, W/T3	70	50 - 95 (95)	37	M10	Hex socket cap (WAF: 8 mm)	12 - 14 (107 - 124)
	-, -, +1, +1 ^{*5 *6}	35	16 - 50 (50)	28	M6	Hex socket cap (WAF: 5 mm)	8 - 9 (71 - 80)
	+3 ^{*6}	50	25 - 70 (50 - 70)	28	M8	Hex socket cap (WAF: 6 mm)	8 - 9 (71 - 80)
	⊕	35	25 - 50 (-)	-	M8	Hex bolt (slotted)	9.0 - 11 (79.7 - 97.4)
2211	R/L1, S/L2, T/L3	95	50 - 95 (95)	37	M10	Hex socket cap (WAF: 8 mm)	12 - 14 (107 - 124)
	U/T1, V/T2, W/T3	95	50 - 95 (95)	37	M10	Hex socket cap (WAF: 8 mm)	12 - 14 (107 - 124)
	-, -, +1, +1 ^{*5 *6}	50	16 - 50 (50)	28	M6	Hex socket cap (WAF: 5 mm)	8 - 9 (71 - 80)
	+3 ^{*6}	70	25 - 70 (50 - 70)	28	M8	Hex socket cap (WAF: 6 mm)	8 - 9 (71 - 80)
	⊕	50	25 - 50 (-)	-	M8	Hex bolt (slotted)	9.0 - 11 (79.7 - 97.4)
2257	R/L1, S/L2, T/L3	50 × 2P	25 - 95 × 2P (70 - 95 × 2P)	-	M10	Hex self-locking nut	20 (177)
	U/T1, V/T2, W/T3	50 × 2P	25 - 95 × 2P (70 - 95 × 2P)	-	M10	Hex self-locking nut	20 (177)
	-, +1	70 × 2P	35 - 120 × 2P (120 × 2P)	-	M10	Hex self-locking nut	20 (177)
	+3	35 × 2P	25 - 70 × 2P (70 × 2P)	-	M10	Hex self-locking nut	20 (177)
	⊕	95	95 - 240 (-)	-	M10	Hex bolt (slotted)	18 - 23 (159 - 204)
2313	R/L1, S/L2, T/L3	70 × 2P	25 - 95 × 2P (70 - 95 × 2P)	-	M10	Hex self-locking nut	20 (177)
	U/T1, V/T2, W/T3	70 × 2P	25 - 95 × 2P (70 - 95 × 2P)	-	M10	Hex self-locking nut	20 (177)
	-, +1	95 × 2P	35 - 120 × 2P (120 × 2P)	-	M10	Hex self-locking nut	20 (177)
	+3	50 × 2P	25 - 70 × 2P (70 × 2P)	-	M10	Hex self-locking nut	20 (177)
	⊕	95	95 - 240 (-)	-	M10	Hex bolt (slotted)	18 - 23 (159 - 204)

5.2 European Standards

Model	Terminals	Recommended Gauge mm ²	Applicable Gauge (IP20 Applicable Gauge ^{*1}) mm ²	Wire Stripping Length ^{*2} mm	Terminal Screw		Tightening Torque N·m (in·lb)
					Size	Shape	
2360	R/L1, S/L2, T/L3	120 × 2P	70 - 150 × 2P (150 × 2P)	-	M12	Hex self-locking nut	35 (310)
	U/T1, V/T2, W/T3	120 × 2P	70 - 150 × 2P (150 × 2P)	-	M12	Hex self-locking nut	35 (310)
	-, +1	120 × 2P	95 - 185 × 2P (185 × 2P)	-	M12	Hex self-locking nut	35 (310)
	+3	70 × 2P	50 - 95 × 2P (-)	-	M12	Hex self-locking nut	35 (310)
	⊕	120	120 - 240 (-)	-	M12	Hex bolt (slotted)	32 - 40 (283 - 354)
2415	R/L1, S/L2, T/L3	120 × 2P	70 - 150 × 2P (150 × 2P)	-	M12	Hex self-locking nut	35 (310)
	U/T1, V/T2, W/T3	120 × 2P	70 - 150 × 2P (150 × 2P)	-	M12	Hex self-locking nut	35 (310)
	-, +1	120 × 2P	95 - 185 × 2P (185 × 2P)	-	M12	Hex self-locking nut	35 (310)
	+3	70 × 2P	50 - 95 × 2P (-)	-	M12	Hex self-locking nut	35 (310)
	⊕	120	120 - 240 (-)	-	M12	Hex bolt (slotted)	32 - 40 (283 - 354)

*1 For IP20 protection, use wires that are in the range of applicable gauges.

*2 Remove insulation from the ends of wires to expose the length of wire shown.

*3 For wire gauges more than 30 mm², tighten to a tightening torque of 4.1 N·m to 4.5 N·m (36 in·lb to 40 in·lb).

*4 Install a GFCI with this wire gauge to maintain compliance with IEC/EN 61800-5-1:2007.

*5 Terminals - and +1 have two screws. The Recommended Gauge is the wire gauge for one terminal.

*6 A junction terminal is necessary to connect a braking unit (CDBR series) to terminals - and +3.

Three-Phase 400 V Class

Model	Terminal	Recommended Gauge mm ²	Applicable Gauge (IP20 Applicable Gauge ^{*1}) mm ²	Wire Stripping Length ^{*2} mm	Terminal Screw		Tightening Torque N·m (in·lb)
					Size	Shape	
4002	R/L1, S/L2, T/L3	2.5	2.5 - 10 (2.5 - 10)	10	M4	Slotted (-)	1.5 - 1.7 (13.5 - 15)
	U/T1, V/T2, W/T3	2.5	2.5 - 10 (2.5 - 10)	10	M4	Slotted (-)	1.5 - 1.7 (13.5 - 15)
	-, +1, +2	2.5	2.5 - 16 (2.5 - 16)	18	M5	Slotted (-)	2.3 - 2.5 (19.8 - 22) ^{*3}
	B1, B2	2.5	2.5 - 4 (2.5 - 4)	10	M4	Slotted (-)	1.5 - 1.7 (13.5 - 15)
	⊕	2.5 ^{*4}	2.5 - 10 (-)	-	M4	Phillips/slotted combo	1.2 - 1.5 (10.6 - 13.3)
4004	R/L1, S/L2, T/L3	2.5	2.5 - 10 (2.5 - 10)	10	M4	Slotted (-)	1.5 - 1.7 (13.5 - 15)
	U/T1, V/T2, W/T3	2.5	2.5 - 10 (2.5 - 10)	10	M4	Slotted (-)	1.5 - 1.7 (13.5 - 15)
	-, +1, +2	2.5	2.5 - 16 (2.5 - 16)	18	M5	Slotted (-)	2.3 - 2.5 (19.8 - 22) ^{*3}
	B1, B2	2.5	2.5 - 4 (2.5 - 4)	10	M4	Slotted (-)	1.5 - 1.7 (13.5 - 15)
	⊕	2.5 ^{*4}	2.5 - 10 (-)	-	M4	Phillips/slotted combo	1.2 - 1.5 (10.6 - 13.3)

Model	Terminal	Recommended Gauge mm ²	Applicable Gauge (IP20 Applicable Gauge ^{*1}) mm ²	Wire Stripping Length ^{*2} mm	Terminal Screw		Tightening Torque N·m (in·lb)
					Size	Shape	
4005	R/L1, S/L2, T/L3	2.5	2.5 - 10 (2.5 - 10)	10	M4	Slotted (-)	1.5 - 1.7 (13.5 - 15)
	U/T1, V/T2, W/T3	2.5	2.5 - 10 (2.5 - 10)	10	M4	Slotted (-)	1.5 - 1.7 (13.5 - 15)
	-, +1, +2	2.5	2.5 - 16 (2.5 - 16)	18	M5	Slotted (-)	2.3 - 2.5 (19.8 - 22) ^{*3}
	B1 , B2	2.5	2.5 - 4 (2.5 - 4)	10	M4	Slotted (-)	1.5 - 1.7 (13.5 - 15)
	⊕	2.5 ^{*4}	2.5 - 10 (-)	-	M4	Phillips/slotted combo	1.2 - 1.5 (10.6 - 13.3)
4007	R/L1, S/L2, T/L3	2.5	2.5 - 10 (2.5 - 10)	10	M4	Slotted (-)	1.5 - 1.7 (13.5 - 15)
	U/T1, V/T2, W/T3	2.5	2.5 - 10 (2.5 - 10)	10	M4	Slotted (-)	1.5 - 1.7 (13.5 - 15)
	-, +1, +2	2.5	2.5 - 16 (2.5 - 16)	18	M5	Slotted (-)	2.3 - 2.5 (19.8 - 22) ^{*3}
	B1 , B2	2.5	2.5 - 4 (2.5 - 4)	10	M4	Slotted (-)	1.5 - 1.7 (13.5 - 15)
	⊕	2.5 ^{*4}	2.5 - 10 (-)	-	M4	Phillips/slotted combo	1.2 - 1.5 (10.6 - 13.3)
4009	R/L1, S/L2, T/L3	2.5	2.5 - 10 (2.5 - 10)	10	M4	Slotted (-)	1.5 - 1.7 (13.5 - 15)
	U/T1, V/T2, W/T3	2.5	2.5 - 10 (2.5 - 10)	10	M4	Slotted (-)	1.5 - 1.7 (13.5 - 15)
	-, +1, +2	2.5	2.5 - 16 (2.5 - 16)	18	M5	Slotted (-)	2.3 - 2.5 (19.8 - 22) ^{*3}
	B1 , B2	2.5	2.5 - 4 (2.5 - 4)	10	M4	Slotted (-)	1.5 - 1.7 (13.5 - 15)
	⊕	2.5 ^{*4}	2.5 - 10 (-)	-	M4	Phillips/slotted combo	1.2 - 1.5 (10.6 - 13.3)
4012	R/L1, S/L2, T/L3	2.5	2.5 - 10 (2.5 - 10)	10	M4	Slotted (-)	1.5 - 1.7 (13.5 - 15)
	U/T1, V/T2, W/T3	2.5	2.5 - 10 (2.5 - 10)	10	M4	Slotted (-)	1.5 - 1.7 (13.5 - 15)
	-, +1, +2	2.5	2.5 - 16 (2.5 - 16)	18	M5	Slotted (-)	2.3 - 2.5 (19.8 - 22) ^{*3}
	B1 , B2	2.5	2.5 - 4 (2.5 - 4)	10	M4	Slotted (-)	1.5 - 1.7 (13.5 - 15)
	⊕	2.5 ^{*4}	2.5 - 10 (-)	-	M4	Phillips/slotted combo	1.2 - 1.5 (10.6 - 13.3)
4018	R/L1, S/L2, T/L3	2.5	2.5 - 10 (2.5 - 10)	10	M4	Slotted (-)	1.5 - 1.7 (13.5 - 15)
	U/T1, V/T2, W/T3	2.5	2.5 - 10 (2.5 - 10)	10	M4	Slotted (-)	1.5 - 1.7 (13.5 - 15)
	-, +1, +2	4	2.5 - 16 (2.5 - 16)	18	M5	Slotted (-)	2.3 - 2.5 (19.8 - 22) ^{*3}
	B1 , B2	2.5	2.5 - 4 (2.5 - 4)	10	M4	Slotted (-)	1.5 - 1.7 (13.5 - 15)
	⊕	2.5 ^{*4}	2.5 - 10 (-)	-	M5	Phillips/slotted combo	2.0 - 2.5 (17.7 - 22.1)

5.2 European Standards

Model	Terminal	Recommended Gauge mm ²	Applicable Gauge (IP20 Applicable Gauge ^{*1}) mm ²	Wire Stripping Length ^{*2} mm	Terminal Screw		Tightening Torque N·m (in·lb)
					Size	Shape	
4023	R/L1, S/L2, T/L3	6	2.5 - 10 (2.5 - 10)	10	M4	Slotted (-)	1.5 - 1.7 (13.5 - 15)
	U/T1, V/T2, W/T3	4	2.5 - 10 (2.5 - 10)	10	M4	Slotted (-)	1.5 - 1.7 (13.5 - 15)
	-, +1, +2	6	2.5 - 16 (2.5 - 16)	18	M5	Slotted (-)	2.3 - 2.5 (19.8 - 22) ^{*3}
	B1 , B2	2.5	2.5 - 4 (2.5 - 4)	10	M4	Slotted (-)	1.5 - 1.7 (13.5 - 15)
	⊕	6 ^{*4}	4 - 10 (-)	-	M5	Phillips/slotted combo	2.0 - 2.5 (17.7 - 22.1)
4031	R/L1, S/L2, T/L3	10	2.5 - 25 (10 - 25)	18	M5	Slotted (-)	2.3 - 2.5 (19.8 - 22) ^{*3}
	U/T1, V/T2, W/T3	6	2.5 - 16 (6 - 16)	18	M5	Slotted (-)	2.3 - 2.5 (19.8 - 22) ^{*3}
	-, +1, +2	10	2.5 - 35 (10 - 35)	20	M6	Hex socket cap (WAF: 5 mm)	5 - 5.5 (45 - 49)
	B1 , B2	2.5	2.5 - 10 (2.5 - 10)	10	M4	Slotted (-)	1.5 - 1.7 (13.5 - 15)
	⊕	10	6 - 16 (-)	-	M6	Phillips/slotted combo	5.4 - 6.0 (47.8 - 53.1)
4038	R/L1, S/L2, T/L3	10	2.5 - 25 (10 - 25)	18	M5	Slotted (-)	2.3 - 2.5 (19.8 - 22) ^{*3}
	U/T1, V/T2, W/T3	6	2.5 - 16 (6 - 16)	18	M5	Slotted (-)	2.3 - 2.5 (19.8 - 22) ^{*3}
	-, +1, +2	16	2.5 - 35 (10 - 35)	20	M6	Hex socket cap (WAF: 5 mm)	5 - 5.5 (45 - 49)
	B1 , B2	4	2.5 - 10 (2.5 - 10)	10	M4	Slotted (-)	1.5 - 1.7 (13.5 - 15)
	⊕	10	6 - 16 (-)	-	M6	Phillips/slotted combo	5.4 - 6.0 (47.8 - 53.1)
4044	R/L1, S/L2, T/L3	16	2.5 - 16 (4 - 16)	18	M5	Slotted (-)	2.3 - 2.5 (19.8 - 22) ^{*3}
	U/T1, V/T2, W/T3	10	2.5 - 10 (6 - 10)	18	M5	Slotted (-)	2.3 - 2.5 (19.8 - 22) ^{*3}
	-, +1, +2	25	2.5 - 25 (6 - 25)	18	M5	Slotted (-)	2.3 - 2.5 (19.8 - 22) ^{*3}
	B1 , B2	6	2.5 - 6 (2.5 - 6)	10	M4	Slotted (-)	1.5 - 1.7 (13.5 - 15)
	⊕	16	10 - 25 (-)	-	M6	Phillips/slotted combo	5.4 - 6.0 (47.8 - 53.1)
4060	R/L1, S/L2, T/L3	16	2.5 - 16 (4 - 16)	18	M5	Slotted (-)	2.3 - 2.5 (19.8 - 22) ^{*3}
	U/T1, V/T2, W/T3	16	2.5 - 16 (6 - 16)	18	M5	Slotted (-)	2.3 - 2.5 (19.8 - 22) ^{*3}
	-, +1	25	2.5 - 25 (6 - 25)	18	M5	Slotted (-)	2.3 - 2.5 (19.8 - 22) ^{*3}
	B1 , B2	10	2.5 - 10 (2.5 - 10)	10	M4	Slotted (-)	1.5 - 1.7 (13.5 - 15)
	⊕	16	10 - 25 (-)	-	M6	Phillips/slotted combo	5.4 - 6.0 (47.8 - 53.1)

Model	Terminal	Recommended Gauge mm ²	Applicable Gauge (IP20 Applicable Gauge ^{*1}) mm ²	Wire Stripping Length ^{*2} mm	Terminal Screw		Tightening Torque N-m (in-lb)
					Size	Shape	
4075	R/L1, S/L2, T/L3	25	2.5 - 25 (2.5 - 25)	18	M5	Slotted (-)	2.3 - 2.5 (19.8 - 22) ^{*3}
	U/T1, V/T2, W/T3	25	2.5 - 25 (2.5 - 25)	18	M5	Slotted (-)	2.3 - 2.5 (19.8 - 22) ^{*3}
	-, +1	25	2.5 - 25 (4 - 25)	18	M5	Slotted (-)	2.3 - 2.5 (19.8 - 22) ^{*3}
	B1 , B2	10	2.5 - 10 (2.5 - 10)	10	M4	Slotted (-)	1.5 - 1.7 (13.5 - 15)
	⊕	16	16 - 25 (-)	-	M6	Hex bolt (+)	5.4 - 6.0 (47.8 - 53.1)
4089	R/L1, S/L2, T/L3	25	2.5 - 25 (10 - 25)	18	M5	Slotted (-)	2.3 - 2.5 (19.8 - 22) ^{*3}
	U/T1, V/T2, W/T3	25	2.5 - 25 (10 - 25)	18	M5	Slotted (-)	2.3 - 2.5 (19.8 - 22) ^{*3}
	-, +1	35	2.5 - 35 (16 - 35)	20	M6	Hex socket cap (WAF: 5 mm)	5 - 5.5 (45 - 49)
	B1 , B2	16	2.5 - 16 (4 - 16)	18	M5	Slotted (-)	2.3 - 2.5 (19.8 - 22) ^{*3}
	⊕	16	16 - 25 (-)	-	M6	Hex bolt (+)	5.4 - 6.0 (47.8 - 53.1)
4103	R/L1, S/L2, T/L3	35	16 - 50 (50)	27	M6	Hex socket cap (WAF: 5 mm)	8 - 9 (71 - 80)
	U/T1, V/T2, W/T3	35	16 - 50 (50)	27	M6	Hex socket cap (WAF: 5 mm)	8 - 9 (71 - 80)
	-, +1	50	25 - 70 (50 - 70)	27	M8	Hex socket cap (WAF: 6 mm)	10 - 12 (89 - 107)
	B1 , B2	25	6 - 35 (6 - 35)	21	M6	Slotted (-)	3 - 3.5 (27 - 31)
	⊕	16	16 - 25 (-)	-	M6	Hex bolt (+)	5.4 - 6.0 (47.8 - 53.1)
4140	R/L1, S/L2, T/L3	50	50 - 95 (95)	37	M10	Hex socket cap (WAF: 8 mm)	12 - 14 (107 - 124)
	U/T1, V/T2, W/T3	50	50 - 95 (95)	37	M10	Hex socket cap (WAF: 8 mm)	12 - 14 (107 - 124)
	-, -, +1 , +1 ^{*5}	25	16 - 50 (50)	28	M6	Hex socket cap (WAF: 5 mm)	8 - 9 (71 - 80)
	B1 , B2 ^{*6}	50	25 - 70 (50 - 70)	28	M8	Hex socket cap (WAF: 6 mm)	8 - 9 (71 - 80)
	⊕	25	25 - 50 (-)	-	M8	Hex bolt (slotted)	9.0 - 11 (79.7 - 97.4)
4168	R/L1, S/L2, T/L3	70	50 - 95 (95)	37	M10	Hex socket cap (WAF: 8 mm)	12 - 14 (107 - 124)
	U/T1, V/T2, W/T3	70	50 - 95 (95)	37	M10	Hex socket cap (WAF: 8 mm)	12 - 14 (107 - 124)
	-, -, +1 , +1 ^{*5}	35	16 - 50 (50)	28	M6	Hex socket cap (WAF: 5 mm)	8 - 9 (71 - 80)
	B1 , B2 ^{*6}	50	25 - 70 (50 - 70)	28	M8	Hex socket cap (WAF: 6 mm)	8 - 9 (71 - 80)
	⊕	35	25 - 50 (-)	-	M8	Hex bolt (slotted)	9.0 - 11 (79.7 - 97.4)

5.2 European Standards

Model	Terminal	Recommended Gauge mm ²	Applicable Gauge (IP20 Applicable Gauge *1) mm ²	Wire Stripping Length *2 mm	Terminal Screw		Tightening Torque N·m (in·lb)
					Size	Shape	
4208	R/L1, S/L2, T/L3	50 × 2P	25 - 95 × 2P (70 - 95 × 2P)	-	M10	Hex self-locking nut	20 (177)
	U/T1, V/T2, W/T3	50 × 2P	25 - 95 × 2P (70 - 95 × 2P)	-	M10	Hex self-locking nut	20 (177)
	-, +1	70 × 2P	35 - 120 × 2P (120 × 2P)	-	M10	Hex self-locking nut	20 (177)
	+3	35 × 2P	25 - 70 × 2P (70 × 2P)	-	M10	Hex self-locking nut	20 (177)
	⊕	50	50 - 240 (-)	-	M10	Hex bolt (slotted)	18 - 23 (159 - 204)
4250	R/L1, S/L2, T/L3	50 × 2P	25 - 95 × 2P (70 - 95 × 2P)	-	M10	Hex self-locking nut	20 (177)
	U/T1, V/T2, W/T3	50 × 2P	25 - 95 × 2P (70 - 95 × 2P)	-	M10	Hex self-locking nut	20 (177)
	-, +1	70 × 2P	35 - 120 × 2P (120 × 2P)	-	M10	Hex self-locking nut	20 (177)
	+3	50 × 2P	25 - 70 × 2P (70 × 2P)	-	M10	Hex self-locking nut	20 (177)
	⊕	70	70 - 240 (-)	-	M10	Hex bolt (slotted)	18 - 23 (159 - 204)
4302	R/L1, S/L2, T/L3	70 × 2P	25 - 95 × 2P (70 - 95 × 2P)	-	M10	Hex self-locking nut	20 (177)
	U/T1, V/T2, W/T3	70 × 2P	25 - 95 × 2P (70 - 95 × 2P)	-	M10	Hex self-locking nut	20 (177)
	-, +1	95 × 2P	35 - 120 × 2P (120 × 2P)	-	M10	Hex self-locking nut	20 (177)
	+3	70 × 2P	25 - 70 × 2P (70 × 2P)	-	M10	Hex self-locking nut	20 (177)
	⊕	95	95 - 240 (-)	-	M10	Hex bolt (slotted)	18 - 23 (159 - 204)
4371	R/L1, S/L2, T/L3	120 × 2P	70 - 150 × 2P (150 × 2P)	-	M12	Hex self-locking nut	35 (310)
	U/T1, V/T2, W/T3	120 × 2P	70 - 150 × 2P (150 × 2P)	-	M12	Hex self-locking nut	35 (310)
	-, +1	120 × 2P	95 - 185 × 2P (185 × 2P)	-	M12	Hex self-locking nut	35 (310)
	+3	70 × 2P	50 - 95 × 2P (-)	-	M12	Hex self-locking nut	35 (310)
	⊕	120	120 - 240 (-)	-	M12	Hex bolt (slotted)	32 - 40 (283 - 354)
4414	R/L1, S/L2, T/L3	120 × 2P	70 - 150 × 2P (150 × 2P)	-	M12	Hex self-locking nut	35 (310)
	U/T1, V/T2, W/T3	120 × 2P	70 - 150 × 2P (150 × 2P)	-	M12	Hex self-locking nut	35 (310)
	-, +1	120 × 2P	95 - 185 × 2P (185 × 2P)	-	M12	Hex self-locking nut	35 (310)
	+3	95 × 2P	50 - 95 × 2P (-)	-	M12	Hex self-locking nut	35 (310)
	⊕	95	35 - 240 (-)	-	M12	Hex bolt (slotted)	32 - 40 (283 - 354)

Model	Terminal	Recommended Gauge mm ²	Applicable Gauge (IP20 Applicable Gauge ^{*1}) mm ²	Wire Stripping Length ^{*2} mm	Terminal Screw		Tightening Torque N·m (in·lb)
					Size	Shape	
4477	R/L1, S/L2, T/L3	120 × 4P	70 - 150 × 4P (150 × 4P)	-	M12	Hex self-locking nut	35 (310)
	U/T1, V/T2, W/T3	95 × 4P	70 - 150 × 4P (120 - 150 × 4P)	-	M12	Hex self-locking nut	35 (310)
	-, +1	95 × 4P	95 - 185 × 4P (185 × 4P)	-	M12	Hex self-locking nut	35 (310)
	+3	70 × 4P	35 - 95 × 4P (95 × 4P)	-	M12	Hex self-locking nut	35 (310)
	⊕	150	50 - 150 (-)	-	M12	Hex bolt (slotted)	32 - 40 (283 - 354)
4568	R/L1, S/L2, T/L3	120 × 4P	70 - 150 × 4P (150 × 4P)	-	M12	Hex self-locking nut	35 (310)
	U/T1, V/T2, W/T3	95 × 4P	70 - 150 × 4P (120 - 150 × 4P)	-	M12	Hex self-locking nut	35 (310)
	-, +1	95 × 4P	95 - 185 × 4P (185 × 4P)	-	M12	Hex self-locking nut	35 (310)
	+3	70 × 4P	35 - 95 × 4P (95 × 4P)	-	M12	Hex self-locking nut	35 (310)
	⊕	95 × 2P	60 - 150 (-)	-	M12	Hex bolt (slotted)	32 - 40 (283 - 354)
4605	R/L1, S/L2, T/L3	120 × 4P	70 - 150 × 4P (150 × 4P)	-	M12	Hex self-locking nut	35 (310)
	U/T1, V/T2, W/T3	95 × 4P	70 - 150 × 4P (120 - 150 × 4P)	-	M12	Hex self-locking nut	35 (310)
	-, +1	95 × 4P	95 - 185 × 4P (185 × 4P)	-	M12	Hex self-locking nut	35 (310)
	+3	70 × 4P	35 - 95 × 4P (95 × 4P)	-	M12	Hex self-locking nut	35 (310)
	⊕	95 × 2P	60 - 150 (-)	-	M12	Hex bolt (slotted)	32 - 40 (283 - 354)
4720	R/L1, S/L2, T/L3	120 × 4P	70 - 150 × 4P (150 × 4P)	-	M12	Hex self-locking nut	35 (310)
	U/T1, V/T2, W/T3	95 × 4P	70 - 150 × 4P (120 - 150 × 4P)	-	M12	Hex self-locking nut	35 (310)
	-, +1	95 × 4P	95 - 185 × 4P (185 × 4P)	-	M12	Hex self-locking nut	35 (310)
	+3	70 × 4P	35 - 95 × 4P (95 × 4P)	-	M12	Hex self-locking nut	35 (310)
	⊕	95 × 2P	60 - 150 (-)	-	M12	Hex bolt (slotted)	32 - 40 (283 - 354)

*1 For IP20 protection, use wires that are in the range of applicable gauges.

*2 Remove insulation from the ends of wires to expose the length of wire shown.

*3 For wire gauges more than 30 mm², tighten to a tightening torque of 4.1 N·m to 4.5 N·m (36 in·lb to 40 in·lb).

*4 Install a GFCI with this wire gauge to maintain compliance with IEC/EN 61800-5-1:2007.

*5 Terminals - and +1 have two screws. The Recommended Gauge is the wire gauge for one terminal.

*6 A junction terminal is necessary to connect a braking resistor unit (LKEB-series) to terminals B1 and B2.

■ Connect a Fuse to the Input Side (Primary Side)

The drive circuit protection must comply with IEC/EN 61800-5-1:2007 for protection against a short circuit in the internal circuitry. Yaskawa recommends connecting semiconductor protection fuses on the input side for branch circuit protection.

5.2 European Standards

WARNING! Electrical Shock Hazard. After the drive blows a fuse or trips a GFCI, do not immediately energize the drive or operate peripheral devices. Wait for the time specified on the warning label at a minimum and make sure that all indicators are OFF. Then check the wiring and peripheral device ratings to find the cause of the problem. If you do not know the cause of the problem, contact Yaskawa before you energize the drive or peripheral devices. If you do not fix the problem before you operate the drive or peripheral devices, it can cause serious injury or death.

Table 5.2 Factory-Recommended Branch Circuit Protection (200 V Class)

Drive Model	Semiconductor Protection Fuse Rated Current Manufacturer: EATON/Bussmann	Drive Model	Semiconductor Protection Fuse Rated Current Manufacturer: EATON/Bussmann
2004	FWH-45B	2082	FWH-225A FWH-250A <i>*1</i>
2006	FWH-45B	2110	FWH-225A FWH-250A <i>*1</i>
2008	FWH-45B	2138	FWH-275A FWH-300A <i>*1</i>
2010	FWH-45B	2169	FWH-275A FWH-350A <i>*1</i>
2012	FWH-50B	2211	FWH-325A FWH-450A <i>*1</i>
2018	FWH-80B	2257	FWH-600A
2021	FWH-80B	2313	FWH-800A
2030	FWH-125B	2360	FWH-1000A
2042	FWH-150B	2415	FWH-1000A
2056	FWH-200B		
2070	FWH-225A		

*1 Yaskawa recommends a fuse with a large rated current for applications with repeated loads.

Table 5.3 Factory-Recommended Branch Circuit Protection (400 V Class)

Drive Model	Semiconductor Protection Fuse Rated Current Manufacturer: EATON/Bussmann	Drive Model	Semiconductor Protection Fuse Rated Current Manufacturer: EATON/Bussmann
4002	FWH-50B	4103	FWH-275A
4004	FWH-50B	4140	FWH-300A
4005	FWH-50B	4168	FWH-325A FWH-400A <i>*1</i>
4007	FWH-60B	4208	FWH-500A
4009	FWH-60B	4250	FWH-600A
4012	FWH-60B	4302	FWH-700A
4018	FWH-80B	4371	FWH-800A
4023	FWH-90B	4414	FWH-1000A
4031	FWH-150B	4477	FWH-1200A
4038	FWH-200B	4568	FWH-1200A
4044	FWH-200B	4605	FWH-1400A FWH-1600A <i>*1</i>
4060	FWH-225A	4720	FWH-1400A FWH-1600A <i>*1</i>
4075	FWH-250A		
4089	FWH-275A		

*1 Yaskawa recommends a fuse with a large rated current for applications with repeated loads.

■ CE Standards Compliance for DC Power Supply Input

To comply with CE Standards, install a fuse for the DC power supply input.

Figure 5.3 shows a wiring example for a DC power supply that has two drives connected in parallel.

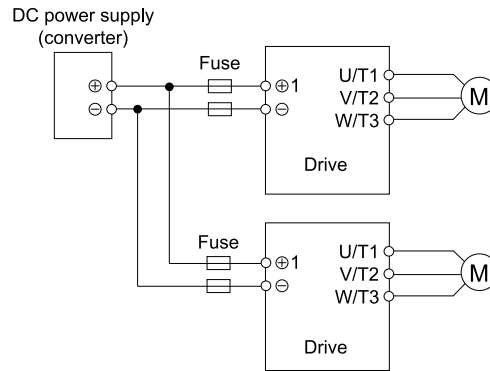

Figure 5.3 Wiring Example for DC Power Supply Input

WARNING! *Electrical Shock Hazard. Do not ground the main circuit bus. Incorrect wiring can cause serious injury or death.*

Note:

- Install a fuse for each drive when operating more than one drive. If one fuse blows, replace all fuses.
- Install the external filter (system) to comply with the EMC Directive.

Refer to [Table 5.4](#) and [Table 5.5](#) for the recommended fuses.

Table 5.4 Recommended Fuse (Three-Phase 200 V Class)

Drive Model	Fuse Manufacturer: Busmann	
	Model	Quantity
2004	FWH-45B	2
2006	FWH-45B	2
2008	FWH-45B	2
2010	FWH-45B	2
2012	FWH-50B	2
2018	FWH-80B	2
2021	FWH-80B	2
2030	FWH-125B	2
2042	FWH-150B	2
2056	FWH-200B	2
2070	FWH-250A	2
2082	FWH-250A FWH-300A <i>*1</i>	2
2110	FWH-250A FWH-275A <i>*1</i>	2
2138	FWH-300A FWH-350A <i>*1</i>	2
2169	FWH-350A FWH-450A <i>*1</i>	2
2211	FWH-450A FWH-600A <i>*1</i>	2
2257	FWH-600A FWH-700A <i>*1</i>	2
2313	FWH-800A FWH-1000A <i>*1</i>	2
2360	FWH-1000A	2
2415	FWH-1000A	2

*1 Yaskawa recommends a fuse with a large rated current for applications with repeated loads.

Table 5.5 Recommended Fuse (Three-Phase 400 V Class)

Drive Model	Fuse Manufacturer: Bussmann	
	Model	Quantity
4002	FWH-50B	2
4004	FWH-50B	2
4005	FWH-50B	2
4007	FWH-60B	2
4009	FWH-60B	2
4012	FWH-60B	2
4018	FWH-80B	2
4023	FWH-90B	2
4031	FWH-150B	2
4038	FWH-200B	2
4044	FWH-200B	2
4060	FWH-225A	2
4075	FWH-250A	2
4089	FWH-275A	2
4103	FWH-275A	2
4140	FWH-300A FWH-325A <i>*1</i>	2
4168	FWH-400A FWH-450A <i>*1</i>	2
4208	FWH-500A FWH-600A <i>*1</i>	2
4250	FWH-600A FWH-700A <i>*1</i>	2
4302	FWH-700A FWH-800A <i>*1</i>	2
4371	FWH-800A FWH-1000A <i>*1</i>	2
4414	FWH-1000A FWH-1200A <i>*1</i>	2
4477	FWH-1200A FWH-1400A <i>*1</i>	2
4568	FWH-1200A FWH-1600A <i>*1</i>	2
4605	FWH-1600A	2
4720	FWH-1600A	2

*1 Yaskawa recommends a fuse with a large rated current for applications with repeated loads.

■ Braking Unit Connection Wire Gauge (CDBR-Type)

When you connect the braking unit (CDBR-type) to the drive model 2257 to 2415 or 4208 to 4720, refer to [Table 5.6](#) and [Table 5.7](#) to select the wires.

Table 5.6 200 V Class

Drive Model	Braking unit (Quantity)	Drive Terminals	Recommended Gauge (mm ²)	Applicable Gauge (mm ²)
2257	CDBR-2022D (× 2) Specified Wire Gauge	+3	6 × 2P	6 - 10 × 2P
		-	6 × 2P	6 - 10 × 2P
	Applicable Gauge *1	+3	35 × 2P	25 - 70 × 2P
		-	35 × 2P *2	25 - 70 × 2P *2
2313	CDBR-2110D (× 1) Specified Wire Gauge	+3	35	35
		-	35	35
	Applicable Gauge *1	+3	50 × 2P	25 - 70 × 2P
		-	50 × 2P *2	25 - 70 × 2P *2
2360	CDBR-2110D (× 1) Specified Wire Gauge	+3	35	35
		-	35	35
2415	CDBR-2110D (× 1) Specified Wire Gauge	+3	35	35
		-	35	35

*1 This is the wire gauge applicable when you use a braking unit other than Yaskawa braking unit (CDBR-type).

*2 This is the wire gauge applicable when you use the same wires for terminal - and terminal +3.

Table 5.7 400 V Class

Drive Model	Braking unit (Quantity)	Drive Terminals	Recommended Gauge (mm ²)	Applicable Gauge (mm ²)
4208	CDBR-4045D (× 2) Specified Wire Gauge	+3	6 × 2P	6 - 10 × 2P
		-	6 × 2P	6 - 10 × 2P
	Applicable Gauge *1	+3	35 × 2P	25 - 70 × 2P
		-	35 × 2P *2	25 - 70 × 2P *2
4250	CDBR-4220D (× 1) Specified Wire Gauge	+3	35	35
		-	35	35
	Applicable Gauge *1	+3	50 × 2P	25 - 70 × 2P
		-	50 × 2P *2	25 - 70 × 2P *2
4302	CDBR-4220D (× 1) Specified Wire Gauge	+3	35	35
		-	35	35
	Applicable Gauge *1	+3	70 × 2P	25 - 70 × 2P
		-	70 × 2P *2	25 - 70 × 2P *2
4371	CDBR-4220D (× 1) Specified Wire Gauge	+3	35	35
		-	35	35
4414	CDBR-4220D (× 1) Specified Wire Gauge	+3	35	35
		-	35	35
4477	CDBR-4220D (× 1) Specified Wire Gauge	+3	35	35
		-	35	35
	Applicable Gauge *1	+3	70 × 4P	35 - 95 × 4P
		-	70 × 4P *2	35 - 95 × 4P *2

5.2 European Standards

Drive Model	Braking unit (Quantity)	Drive Terminals	Recommended Gauge (mm ²)	Applicable Gauge (mm ²)
4568	CDBR-4220D (× 1) Specified Wire Gauge	+3	35	35
		-	35	35
	Applicable Gauge	+3	70 × 4P	35 - 95 × 4P
		-	70 × 4P *2	35 - 95 × 4P *2
4605 4720	CDBR-4220D (× 2) Specified Wire Gauge	+3	35 × 2P	35 × 2P
		-	35 × 2P	35 × 2P
	Applicable Gauge *1	+3	70 × 4P	35 - 95 × 4P
		-	70 × 4P *2	35 - 95 × 4P *2

*1 This is the wire gauge applicable when you use a braking unit other than Yaskawa braking unit (CDBR-type).

*2 This is the wire gauge applicable when you use the same wires for terminal - and terminal +3.

◆ EMC Directive

Install external EMC filters to the drive input side to comply with the EMC Directive. Drives with internal EMC filters are not available in the Americas. Refer to [Installing the External EMC Noise Filter on page 230](#) for the installation of the EMC filter.

■ Installing the External EMC Noise Filter

Drive models 2xxxA and 4xxxA must meet conditions in this section to comply with EN 61800-3:2004+A1:2012.

Connect an EMC noise filter to the input side (primary side) that complies with European standards as specified by Yaskawa. Refer to [External EMC Noise Filter Selection on page 233](#) to select the correct EMC noise filter.

Use this procedure to install an EMC noise filter to make machinery and devices added to the drive comply with the EMC Directive.

1. Install the drive and EMC noise filter on the same grounded metal plate.
2. Wire the drive and motor.
3. Ground the wire shielding on the drive side and motor side.

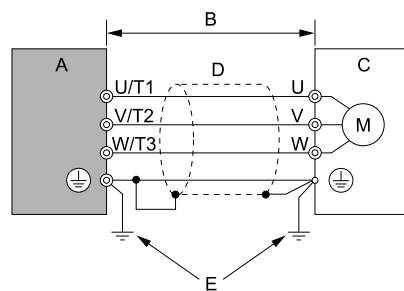

A - Drive

B - 10 m (32.8 ft) maximum

C - Motor

D - Metal conduit

E - Grounding wire

Figure 5.4 Wiring the Drive and Motor

Note:

- Use a braided shield cable for the drive and motor wiring or put the wires through a metal conduit.
- The maximum wiring length between the drive and motor is 10 m (32.8 ft). Keep the cable between the drive and motor as short as possible.
- Keep the grounding wire as short as possible.

4. Use a cable clamp to ground the motor cable to the metal plate.

Note:

Make sure that the protective ground wire complies with technical specifications and local safety standards.

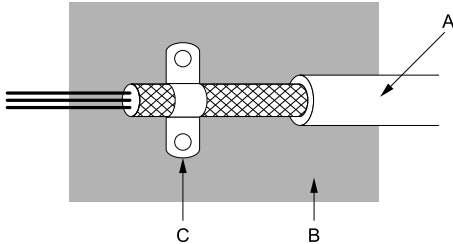

A - Braided shield cable
B - Metal plate

C - Cable clamp (conductive)

Figure 5.5 Ground the Shield

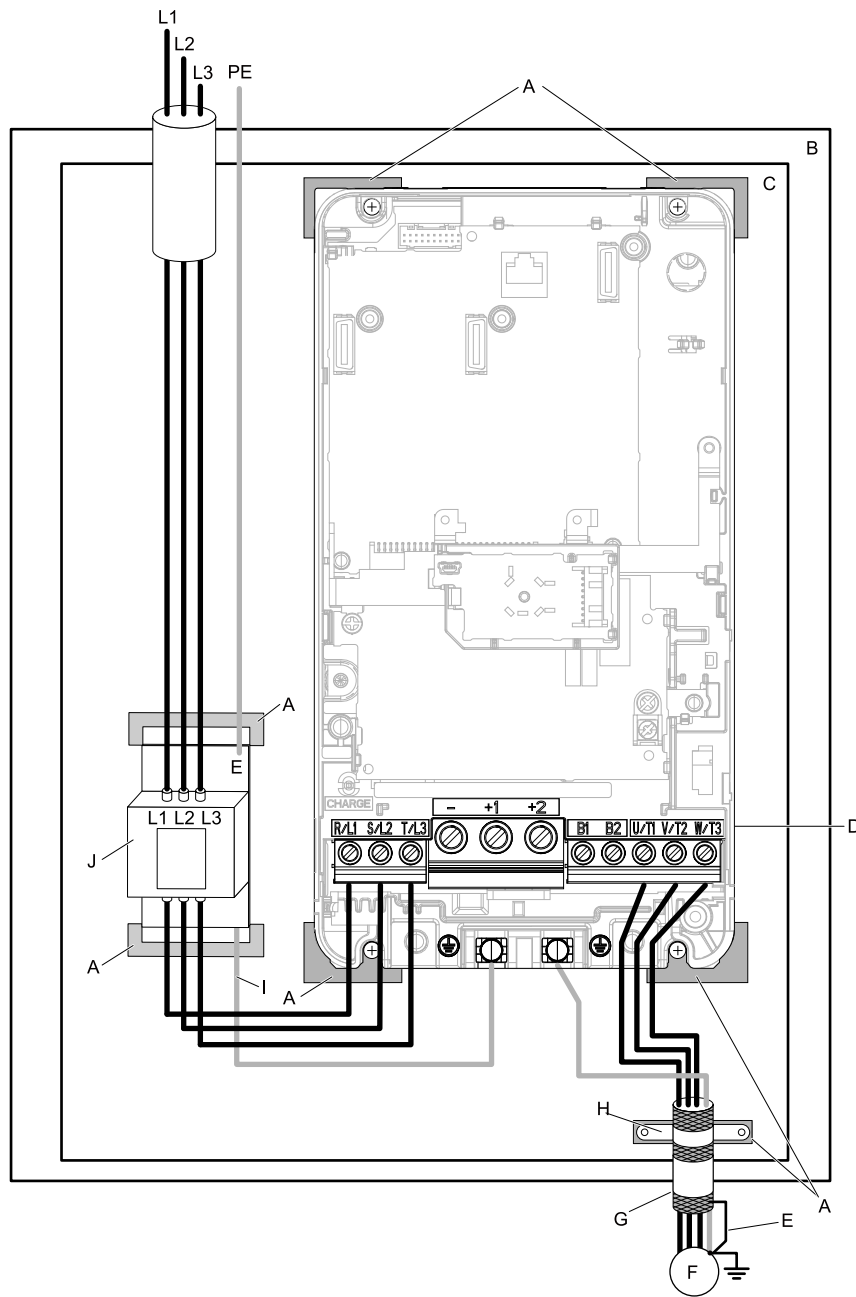

- | | |
|---|--|
| A - Grounding surface (Remove any paint or sealant.) | F - Motor |
| B - Enclosure panel | G - Motor cable (Braided shield cable: max. 10 m (32.8 ft)) |
| C - Metal plate | H - Cable clamp |
| D - Drive | I - Grounding wire |
| E - Ground the shield. | J - EMC noise filter |

Figure 5.6 EMC Noise Filter and Drive Installation Procedure

5. Connect the DC link choke to decrease harmonic distortion. Refer to [DC Link Chokes on page 234](#) to select a DC link choke.

Note:

- To maintain compliance with IEC/EN 61000-3-2 on drive models 2004, 2006, 4002, and 4004, install a DC link choke.
- The main circuit terminal block for the drive, and the terminal blocks for the DC link choke come in different shapes. The drive has a European style terminal block, and the DC link choke has a round terminal block. Correctly prepare the ends of the wiring.

Ground Wiring

WARNING! Electrical Shock Hazard. Do not remove covers or touch circuit boards while the drive is energized. If you touch the internal components of an energized drive, it can cause serious injury or death.

WARNING! Electrical Shock Hazard. Ground the neutral point on the power supply of drive models 2xxxB/C and 4xxxB/C to comply with the EMC Directive before you turn on the EMC filter. If you turn ON the EMC filter, but you do not ground the neutral point, it can cause serious injury or death.

External EMC Noise Filter Selection

Note:

Customer is responsible for EMC emissions with their final product in order to declare CE certification.

Table 5.8 External EMC Noise Filter (2xxxA)

Model	EMC Noise Filter Model	Quantity	Manufacturer
2004A	B84743A0008R176	1	TDK
2006A	B84743A0008R176	1	TDK
2008A	B84743A0017R176	1	TDK
2010A	B84743A0017R176	1	TDK
2012A	B84743A0017R176	1	TDK
2018A	B84743A0033R176	1	TDK
2021A	B84743A0033R176	1	TDK
2030A	B84743A0044R176	1	TDK
2042A	B84743A0060R176	1	TDK
2056A	B84243A6083Z000	1	TDK
2070A	B84243A6120Z000	1	TDK
2082A	B84243A6120Z000	1	TDK
2110A	B84243A0120Z000	1	TDK
2138A	B84243A6180Z000	1	TDK
2169A	B84243A0180Z000	1	TDK
2211A	B84743A0300R176	1	TDK
2257A	B84743A0300R176	1	TDK
2313A	B84743B0410S176	1	TDK
2360A	B84743B0410S176	1	TDK
2415A	B84743B0410S176	1	TDK

Table 5.9 External EMC Noise Filter (4xxxA)

Model	EMC Noise Filter Model	Quantity	Manufacturer
4002A	B84743A0008R176	1	TDK
4004A	B84743A0008R176	1	TDK
4005A	B84743A0008R176	1	TDK
4007A	B84743A0017R176	1	TDK
4009A	B84743A0017R176	1	TDK
4012A	B84743A0017R176	1	TDK
4018A	B84743A0033R176	1	TDK
4023A	B84743A0033R176	1	TDK
4031A	B84743A0044R176	1	TDK
4038A	B84743A0060R176	1	TDK
4044A	B84743A0060R176	1	TDK
4060A	B84743A0060R176	1	TDK

Model	EMC Noise Filter Model	Quantity	Manufacturer
4075A	B84243A6083Z000	1	TDK
4089A	B84243A6120Z000	1	TDK
4103A	B84243A6120Z000	1	TDK
4140A	B84243A6180Z000	1	TDK
4168A	B84243A6180Z000	1	TDK
4208A	B84743A0300R176	1	TDK
4250A	B84743A0300R176	1	TDK
4302A	B84743A0300R176	1	TDK
4371A	B84743B0410S176	1	TDK
4414A	B84743B0410S176	1	TDK
4477A	B84743A0660S176	1	TDK
4568A	B84743A0660S176	1	TDK
4605A	B84743A0660S176	1	TDK
4720A	B84743A1200S176	1	TDK

■ DC Link Chokes

To comply with IEC/EN 61000-3-2, install a DC link choke to drive models 2004, 2006, 4002, and 4004 when using an internal or external EMC filter. Refer to [Table 5.10](#) to select the correct DC link choke.

Table 5.10 DC Link Chokes for Harmonic Suppression (Manufacturer: Yaskawa Electric)

Model	DC Link Choke Model	Rating
2004	UZDA-B	5.4 A, 8 mH
2006	UZDA-B	5.4 A, 8 mH
4002	UZDA-B	3.2 A, 28 mH
4004	UZDA-B	3.2 A, 28 mH

5.3 UL Standards



Figure 5.7 UL/cUL Mark

The UL/cUL Mark indicates that this product satisfies stringent safety standards. This mark appears on products in the United States and Canada. It shows UL approval, indicating that it has been determined that the product complies with safety standards after undergoing strict inspection and assessment. UL Listed or UL Recognized parts must be used for all major components that are built into electrical appliances that obtain UL approval.

This product has been tested in accordance with UL standard UL 508C, and has been verified to be in compliance with UL standards.

Machines and devices integrated with this product must satisfy the following conditions for compliance with UL standards.

◆ Area of Use

Install this product in a location with Overvoltage Category III and pollution degree 2 or less as specified in UL 508C.

■ Ambient Temperature Setting

Maintain the ambient temperature within the following ranges according to the enclosure type.

- IP20/UL Type 1: -10 °C to +40 °C (14 °F to 104 °F)
- IP20/UL Open Type/Heatsink External Mounting: -10 °C to +50 °C (14 °F to 122 °F)
- IP55/UL Type 12 Heatsink External Mounting; front side: -10°C to +50 °C (14 °F to 122 °F)
- IP55/UL Type 12 Heatsink External Mounting; back side: -10°C to +40 °C (14 °F to 104 °F)

◆ Wire the Main Circuit Terminal Block

Wire the main circuit terminal block correctly as specified by the instructions in the manual.

To comply with UL standards on drive models 2257 to 2415 and 4208 to 4720, use UL Listed closed-loop crimp terminals and heat-shrinkable tubing. Use the tools recommend by the terminal manufacturer to crimp the closed-loop crimp terminal. Refer to [Closed-Loop Crimp Terminals on page 247](#) for more information about UL Listed closed-loop crimp terminals.

To select the correct wire gauge, refer to [Three-Phase 200 V Class on page 238](#) and [Three-Phase 400 V Class on page 242](#).

■ Notes on Wiring the Main Circuit Terminal Block

Read these notes before you wire the main circuit terminal block.

Note:

- Use UL-Listed, vinyl-coated insulated copper wires for operation with a continuous maximum permitted temperature of 75 °C at 600 V.
- Remove all unwanted objects that are near the terminal block connections.
- Remove the insulation from the connection wires to the wire stripping lengths shown in the manual.
- Do not use bent or crushed wires. Remove the damaged end of the wire before you use it. Incorrect connections can cause death or serious injury from fire.
- Do not solder stranded wire. Soldered wire connections can become loose over time and cause unsatisfactory drive performance.
- If you use stranded wire, make sure that all of the wire strands are in the connection. Also, do not twist the stranded wire too much. Incorrect connections can cause death or serious injury from fire.
- Put the wire all the way into the terminal block. Remove the insulation from the wire to the recommended wire stripping length to fit the wire with insulation in the plastic housing.
- Use a torque driver, torque ratchet, or torque wrench for the screws. A slotted driver or a hex tool will be necessary to wire the screw clamp terminal. Use applicable tools as specified by the recommended conditions in the product manual.
- If you use power tools to tighten the terminal screws, use a low speed setting (300 to 400 r/min). Failure to obey can cause damage to the terminal screws.
- Users can purchase wiring tools from Yaskawa. Contact Yaskawa or your nearest sales representative for more information.
- Wire gauges on existing drive models to be replaced may not match wire gauge ranges on new drives. Contact Yaskawa or your nearest sales representative for more information about the connection procedures.
- Do not tighten the terminal screws at an angle of 5 degrees or more. Failure to obey can cause damage to the terminal screws.

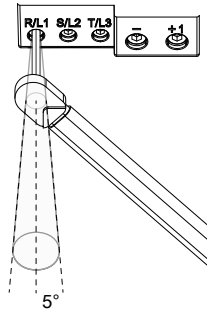

Figure 5.8 Permitted Angle

- Put the bit all the way into the hex socket to tighten the hex socket cap screw.
- When you tighten slotted screws, hold the straight-edge screwdriver perpendicularly to the screw. Make sure that you align the end of the straight-edge screwdriver with the screw groove.

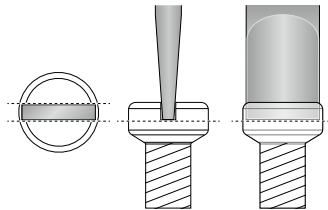
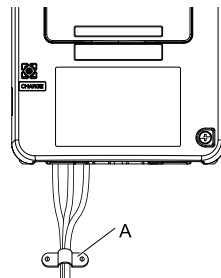

Figure 5.9 Tightening Slotted Screws

- After connecting the wires to the terminal block, lightly pull on the wires to make sure that they do not come out of the terminals.
- Remove the correct section of the wiring cover to make wiring easier.
- Do not let strain on the wiring cause damage. Use a strain relief near the wiring to release the tension. Refer to [Figure 5.10](#) for an example.



A - Cable clamp

Figure 5.10 Strain Relief Example

Table 5.11 Recommended Wiring Tools

Screw Size	Screw Shape	Adapter	Bit		Torque Driver Model (Tightening Torque)	Torque Wrench
			Model	Manufacturer		
M4	Slotted (-)	Bit	SF-BIT-SL 1,0X4,0-70	PHOENIX CONTACT	TSD-M 3NM (1.2 - 3 N·m (10.6 - 26.6 in·lb))	-
M5 ^{*1}	Slotted (-)	Bit	F-BIT-SL 1,2X6,5-70	PHOENIX CONTACT	Wire Gauge ≤ 25 mm ² (AWG 10): TSD-M 3NM (1.2 - 3 N·m (10.6 - 26.6 in·lb))	Wire Gauge ≤ 25 mm ² (AWG 10): -
					Wire Gauge ≥ 30 mm ² (AWG 8): -	Wire Gauge ≥ 30 mm ² (AWG 8): 4.1 - 4.5 N·m (36.3 - 39.8 in·lb) ^{*2 *3}
M6	Hex socket cap (WAF: 5 mm)	Bit	SF-BIT-HEX 5-50	PHOENIX CONTACT	-	5 - 9 N·m (44.3 - 79.7 in·lb) ^{*2 *3}
	Slotted (-)	Bit	SF-BIT-SL 1,2X6,5-70	PHOENIX CONTACT	-	3 - 3.5 N·m (26.6 - 31.0 in·lb) ^{*2 *3}
M8	Hex socket cap (WAF: 6 mm)	Bit	SF-BIT-HEX 6-50	PHOENIX CONTACT	-	8 - 12 N·m (70.8 - 106.2 in·lb) ^{*2 *3}
M10	Hex socket cap (WAF: 8 mm)	Bit	SF-BIT-HEX 8-50	PHOENIX CONTACT	-	12 - 14 N·m (106.2 - 123.9 in·lb) ^{*2 *3}

*1 When wiring drive models 2056 and 4089 and smaller, select the correct tools for the wire gauge.

*2 Use 6.35 mm (0.25 in) bit socket holder.

*3 Use a torque wrench that can apply this torque measurement range.

■ Main Circuit Wire Gauges and Tightening Torques

Refer to *Three-Phase 200 V Class on page 238* and *Three-Phase 400 V Class on page 242* for the recommended wire gauges and tightening torques of the main circuit terminals.

Comply with local standards for correct wire gauges in the region where the drive is used.

WARNING! *Electrical Shock Hazard. Only connect peripheral options, for example a DC link choke or braking resistor, to terminals +1, +2, +3, -, B1, and B2. Incorrect wiring can cause serious injury or death.*

Note:

- The recommended wire gauges are based on drive continuous current ratings with 75 °C (167 °F) 600 V class 2 heat-resistant indoor PVC wire. Assume these conditions:
 - Ambient temperature: 40 °C (104 °F) or lower
 - Wiring distance: 100 m (3281 ft) or shorter
 - Normal Duty Rated current value
- Refer to the instruction manual for each device for recommended wire gauges to connect peripheral devices or options to terminals +1, +2, +3, -, B1, and B2. Contact Yaskawa or your nearest sales representative if the recommended wire gauges for the peripheral devices or options are out of the range of the applicable gauges for the drive.
- 2257 to 2415 and 4208 to 4720, use UL Listed closed-loop crimp terminals on the drive main circuit terminals. Use the tools recommend by the terminal manufacturer and make sure that the terminals are correctly connected.

Three-Phase 200 V Class

Model	Terminals	Recommended Gauge AWG, kcmil	Applicable Gauge (IP20 Applicable Gauge ^{*1}) AWG, kcmil	Wire Stripping Length ^{*2} mm	Terminal Screw		Tightening Torque N-m (in-lb)
					Size	Shape	
2004	R/L1, S/L2, T/L3	14	14 - 6 (14 - 6)	10	M4	Slotted (-)	1.5 - 1.7 (13.5 - 15)
	U/T1, V/T2, W/T3	14	14 - 6 (14 - 6)	10	M4	Slotted (-)	1.5 - 1.7 (13.5 - 15)
	-, +1, +2	14	14 - 3 (14 - 3)	18	M5	Slotted (-)	2.3 - 2.5 (19.8 - 22) ^{*3}
	B1, B2	14	14 - 10 (14 - 10)	10	M4	Slotted (-)	1.5 - 1.7 (13.5 - 15)
	⊕	10	14 - 8 (-)	-	M4	Phillips/slotted combo	1.2 - 1.5 (10.6 - 13.3)
2006	R/L1, S/L2, T/L3	14	14 - 6 (14 - 6)	10	M4	Slotted (-)	1.5 - 1.7 (13.5 - 15)
	U/T1, V/T2, W/T3	14	14 - 6 (14 - 6)	10	M4	Slotted (-)	1.5 - 1.7 (13.5 - 15)
	-, +1, +2	14	14 - 3 (14 - 3)	18	M5	Slotted (-)	2.3 - 2.5 (19.8 - 22) ^{*3}
	B1, B2	14	14 - 10 (14 - 10)	10	M4	Slotted (-)	1.5 - 1.7 (13.5 - 15)
	⊕	10	14 - 8 (-)	-	M4	Phillips/slotted combo	1.2 - 1.5 (10.6 - 13.3)
2008	R/L1, S/L2, T/L3	14	14 - 6 (14 - 6)	10	M4	Slotted (-)	1.5 - 1.7 (13.5 - 15)
	U/T1, V/T2, W/T3	14	14 - 6 (14 - 6)	10	M4	Slotted (-)	1.5 - 1.7 (13.5 - 15)
	-, +1, +2	14	14 - 3 (14 - 3)	18	M5	Slotted (-)	2.3 - 2.5 (19.8 - 22) ^{*3}
	B1, B2	14	14 - 10 (14 - 10)	10	M4	Slotted (-)	1.5 - 1.7 (13.5 - 15)
	⊕	10	14 - 8 (-)	-	M4	Phillips/slotted combo	1.2 - 1.5 (10.6 - 13.3)
2010	R/L1, S/L2, T/L3	12	14 - 6 (14 - 6)	10	M4	Slotted (-)	1.5 - 1.7 (13.5 - 15)
	U/T1, V/T2, W/T3	14	14 - 6 (14 - 6)	10	M4	Slotted (-)	1.5 - 1.7 (13.5 - 15)
	-, +1, +2	12	14 - 3 (14 - 3)	18	M5	Slotted (-)	2.3 - 2.5 (19.8 - 22) ^{*3}
	B1, B2	14	14 - 10 (14 - 10)	10	M4	Slotted (-)	1.5 - 1.7 (13.5 - 15)
	⊕	10	14 - 8 (-)	-	M4	Phillips/slotted combo	1.2 - 1.5 (10.6 - 13.3)
2012	R/L1, S/L2, T/L3	10	14 - 6 (14 - 6)	10	M4	Slotted (-)	1.5 - 1.7 (13.5 - 15)
	U/T1, V/T2, W/T3	12	14 - 6 (14 - 6)	10	M4	Slotted (-)	1.5 - 1.7 (13.5 - 15)
	-, +1, +2	10	14 - 3 (14 - 3)	18	M5	Slotted (-)	2.3 - 2.5 (19.8 - 22) ^{*3}
	B1, B2	14	14 - 10 (14 - 10)	10	M4	Slotted (-)	1.5 - 1.7 (13.5 - 15)
	⊕	10	14 - 8 (-)	-	M4	Phillips/slotted combo	1.2 - 1.5 (10.6 - 13.3)

Model	Terminals	Recommended Gauge AWG, kcmil	Applicable Gauge (IP20 Applicable Gauge ^{*1}) AWG, kcmil	Wire Stripping Length ^{*2} mm	Terminal Screw		Tightening Torque N-m (in-lb)
					Size	Shape	
2018	R/L1, S/L2, T/L3	10	14 - 6 (14 - 6)	10	M4	Slotted (-)	1.5 - 1.7 (13.5 - 15)
	U/T1, V/T2, W/T3	10	14 - 6 (14 - 6)	10	M4	Slotted (-)	1.5 - 1.7 (13.5 - 15)
	-, +1, +2	8	14 - 3 (14 - 3)	18	M5	Slotted (-)	2.3 - 2.5 (19.8 - 22) ^{*3}
	B1, B2	14	14 - 10 (14 - 10)	10	M4	Slotted (-)	1.5 - 1.7 (13.5 - 15)
	⊕	10	14 - 8 (-)	-	M4	Phillips/slotted combo	1.2 - 1.5 (10.6 - 13.3)
2021	R/L1, S/L2, T/L3	8	14 - 6 (14 - 6)	10	M4	Slotted (-)	1.5 - 1.7 (13.5 - 15)
	U/T1, V/T2, W/T3	10	14 - 6 (14 - 6)	10	M4	Slotted (-)	1.5 - 1.7 (13.5 - 15)
	-, +1, +2	8	14 - 3 (14 - 3)	18	M5	Slotted (-)	2.3 - 2.5 (19.8 - 22) ^{*3}
	B1, B2	14	14 - 10 (14 - 10)	10	M4	Slotted (-)	1.5 - 1.7 (13.5 - 15)
	⊕	10	12 - 8 (-)	-	M4	Phillips/slotted combo	1.2 - 1.5 (10.6 - 13.3)
2030	R/L1, S/L2, T/L3	6	14 - 6 (14 - 6)	10	M4	Slotted (-)	1.5 - 1.7 (13.5 - 15)
	U/T1, V/T2, W/T3	8	14 - 6 (14 - 6)	10	M4	Slotted (-)	1.5 - 1.7 (13.5 - 15)
	-, +1, +2	6	14 - 3 (14 - 3)	18	M5	Slotted (-)	2.3 - 2.5 (19.8 - 22) ^{*3}
	B1, B2	12	14 - 10 (14 - 10)	10	M4	Slotted (-)	1.5 - 1.7 (13.5 - 15)
	⊕	8	10 - 8 (-)	-	M5	Phillips/slotted combo	2.0 - 2.5 (17.7 - 22.1)
2042	R/L1, S/L2, T/L3	6	14 - 6 (14 - 6)	10	M4	Slotted (-)	1.5 - 1.7 (13.5 - 15)
	U/T1, V/T2, W/T3	6	14 - 6 (14 - 6)	10	M4	Slotted (-)	1.5 - 1.7 (13.5 - 15)
	-, +1, +2	3	14 - 3 (14 - 3)	18	M5	Slotted (-)	2.3 - 2.5 (19.8 - 22) ^{*3}
	B1, B2	10	14 - 10 (14 - 10)	10	M4	Slotted (-)	1.5 - 1.7 (13.5 - 15)
	⊕	8	10 - 8 (-)	-	M5	Phillips/slotted combo	2.0 - 2.5 (17.7 - 22.1)
2056	R/L1, S/L2, T/L3	3	14 - 3 (8 - 3)	18	M5	Slotted (-)	2.3 - 2.5 (19.8 - 22) ^{*3}
	U/T1, V/T2, W/T3	4	14 - 4 (10 - 4)	18	M5	Slotted (-)	2.3 - 2.5 (19.8 - 22) ^{*3}
	-, +1, +2	1	14 - 1 (8 - 1)	20	M6	Hex socket cap (WAF: 5 mm)	5 - 5.5 (45 - 49)
	B1, B2	8	14 - 8 (14 - 8)	10	M4	Slotted (-)	1.5 - 1.7 (13.5 - 15)
	⊕	6	8 - 6 (-)	-	M6	Phillips/slotted combo	5.4 - 6.0 (47.8 - 53.1)

5.3 UL Standards

Model	Terminals	Recommended Gauge AWG, kcmil	Applicable Gauge (IP20 Applicable Gauge *1) AWG, kcmil	Wire Stripping Length *2 mm	Terminal Screw		Tightening Torque N-m (in-lb)
					Size	Shape	
2070	R/L1, S/L2, T/L3	1	14 - 1 (6 - 1)	20	M6	Hex socket cap (WAF: 5 mm)	5 - 5.5 (45 - 49)
	U/T1, V/T2, W/T3	3	14 - 3 (6 - 3)	20	M6	Hex socket cap (WAF: 5 mm)	5 - 5.5 (45 - 49)
	-, +1, +2	1/0	14 - 1/0 (4 - 1/0)	20	M6	Hex socket cap (WAF: 5 mm)	5 - 5.5 (45 - 49)
	B1, B2	8	14 - 8 (14 - 8)	10	M4	Slotted (-)	1.5 - 1.7 (13.5 - 15)
	⊕	6	6 - 4 (-)	-	M6	Phillips/slotted combo	5.4 - 6.0 (47.8 - 53.1)
2082	R/L1, S/L2, T/L3	1/0	14 - 1/0 (6 - 1/0)	20	M6	Hex socket cap (WAF: 5 mm)	5 - 5.5 (45 - 49)
	U/T1, V/T2, W/T3	2	14 - 2 (6 - 2)	20	M6	Hex socket cap (WAF: 5 mm)	5 - 5.5 (45 - 49)
	-, +1, +2	2/0	14 - 2/0 (4 - 2/0)	20	M6	Hex socket cap (WAF: 5 mm)	5 - 5.5 (45 - 49)
	B1, B2	6	14 - 6 (14 - 6)	10	M4	Slotted (-)	1.5 - 1.7 (13.5 - 15)
	⊕	6	6 - 4 (-)	-	M6	Phillips/slotted combo	5.4 - 6.0 (47.8 - 53.1)
2110	R/L1, S/L2, T/L3	1/0	6 - 1/0 (6 - 1/0)	27	M6	Hex socket cap (WAF: 5 mm)	8 - 9 (71 - 80)
	U/T1, V/T2, W/T3	1/0	6 - 1/0 (6 - 1/0)	27	M6	Hex socket cap (WAF: 5 mm)	8 - 9 (71 - 80)
	-, +1	2/0	2 - 2/0 (2 - 2/0)	27	M8	Hex socket cap (WAF: 6 mm)	10 - 12 (89 - 107)
	B1, B2	4	14 - 4 (10 - 4)	21	M6	Slotted (-)	3 - 3.5 (27 - 31)
	⊕	6	6 - 4 (-)	-	M6	Hex bolt (+)	5.4 - 6.0 (47.8 - 53.1)
2138	R/L1, S/L2, T/L3	2/0	6 - 2/0 (2 - 2/0)	27	M6	Hex socket cap (WAF: 5 mm)	8 - 9 (71 - 80)
	U/T1, V/T2, W/T3	2/0	6 - 2/0 (2 - 2/0)	27	M6	Hex socket cap (WAF: 5 mm)	8 - 9 (71 - 80)
	-, +1	4/0	2 - 4/0 (2 - 4/0)	27	M8	Hex socket cap (WAF: 6 mm)	10 - 12 (89 - 107)
	B1, B2	3	14 - 3 (10 - 3)	21	M6	Slotted (-)	3 - 3.5 (27 - 31)
	⊕	4	4 (-)	-	M6	Hex bolt (+)	5.4 - 6.0 (47.8 - 53.1)
2169	R/L1, S/L2, T/L3	4/0	2 - 250 (2/0 - 250)	37	M10	Hex socket cap (WAF: 8 mm)	12 - 14 (107 - 124)
	U/T1, V/T2, W/T3	4/0	2 - 300 (3/0 - 300)	37	M10	Hex socket cap (WAF: 8 mm)	12 - 14 (107 - 124)
	-, -, +1, +1 *4 *5	1	6 - 2/0 (1/0 - 2/0)	28	M6	Hex socket cap (WAF: 5 mm)	8 - 9 (71 - 80)
	+3 *5	1/0	4 - 2/0 (1 - 2/0)	28	M8	Hex socket cap (WAF: 6 mm)	8 - 9 (71 - 80)
	⊕	4	4 - 1/0 (-)	-	M8	Hex bolt (slotted)	9.0 - 11 (79.7 - 97.4)

Model	Terminals	Recommended Gauge AWG, kcmil	Applicable Gauge (IP20 Applicable Gauge *1) AWG, kcmil	Wire Stripping Length *2 mm	Terminal Screw		Tightening Torque N-m (in-lb)
					Size	Shape	
2211	R/L1, S/L2, T/L3	250	2 - 250 (2/0 - 250)	37	M10	Hex socket cap (WAF: 8 mm)	12 - 14 (107 - 124)
	U/T1, V/T2, W/T3	300	2 - 300 (3/0 - 300)	37	M10	Hex socket cap (WAF: 8 mm)	12 - 14 (107 - 124)
	-, -, +1, +1 *4 *5	2/0	6 - 2/0 (1/0 - 2/0)	28	M6	Hex socket cap (WAF: 5 mm)	8 - 9 (71 - 80)
	+3 *5	2/0	4 - 2/0 (1 - 2/0)	28	M8	Hex socket cap (WAF: 6 mm)	8 - 9 (71 - 80)
	⊕	4	4 - 1/0 (-)	-	M8	Hex bolt (slotted)	9.0 - 11 (79.7 - 97.4)
2257	R/L1, S/L2, T/L3	2/0 × 2P	3 - 4/0 × 2P (2/0 - 4/0 × 2P)	-	M10	Hex self-locking nut	20 (177)
	U/T1, V/T2, W/T3	2/0 × 2P	3 - 4/0 × 2P (2/0 - 4/0 × 2P)	-	M10	Hex self-locking nut	20 (177)
	-, +1	4/0 × 2P	2 - 250 × 2P (4/0 - 250 × 2P)	-	M10	Hex self-locking nut	20 (177)
	+3	1/0 × 2P	4 - 1/0 × 2P (1/0 × 2P)	-	M10	Hex self-locking nut	20 (177)
	⊕	3	3 - 350 (-)	-	M10	Hex bolt (slotted)	18 - 23 (159 - 204)
2313	R/L1, S/L2, T/L3	4/0 × 2P	3 - 4/0 × 2P (2/0 - 4/0 × 2P)	-	M10	Hex self-locking nut	20 (177)
	U/T1, V/T2, W/T3	3/0 × 2P	3 - 4/0 × 2P (2/0 - 4/0 × 2P)	-	M10	Hex self-locking nut	20 (177)
	-, +1	250 × 2P	2 - 250 × 2P (4/0 - 250 × 2P)	-	M10	Hex self-locking nut	20 (177)
	+3	1/0 × 2P	4 - 1/0 × 2P (1/0 × 2P)	-	M10	Hex self-locking nut	20 (177)
	⊕	2	2 - 350 (-)	-	M10	Hex bolt (slotted)	18 - 23 (159 - 204)
2360	R/L1, S/L2, T/L3	250 × 2P	2/0 - 300 × 2P (250 - 300 × 2P)	-	M12	Hex self-locking nut	35 (310)
	U/T1, V/T2, W/T3	250 × 2P	2/0 - 300 × 2P (250 - 300 × 2P)	-	M12	Hex self-locking nut	35 (310)
	-, +1	350 × 2P	4/0 - 400 × 2P (300 - 400 × 2P)	-	M12	Hex self-locking nut	35 (310)
	+3	3/0 × 2P	1/0 - 4/0 × 2P (-)	-	M12	Hex self-locking nut	35 (310)
	⊕	1	1 - 350 (-)	-	M12	Hex bolt (slotted)	32 - 40 (283 - 354)
2415	R/L1, S/L2, T/L3	250 × 2P	2/0 - 300 × 2P (250 - 300 × 2P)	-	M12	Hex self-locking nut	35 (310)
	U/T1, V/T2, W/T3	300 × 2P	2/0 - 300 × 2P (250 - 300 × 2P)	-	M12	Hex self-locking nut	35 (310)
	-, +1	350 × 2P	4/0 - 400 × 2P (300 - 400 × 2P)	-	M12	Hex self-locking nut	35 (310)
	+3	3/0 × 2P	1/0 - 4/0 × 2P (-)	-	M12	Hex self-locking nut	35 (310)
	⊕	1	1 - 350 (-)	-	M12	Hex bolt (slotted)	32 - 40 (283 - 354)

*1 For IP20 protection, use wires that are in the range of applicable gauges.

*2 Remove insulation from the ends of wires to expose the length of wire shown.

5.3 UL Standards

*3 For wire gauges more than AWG 8, tighten to a tightening torque of 4.1 N·m to 4.5 N·m (36 in·lb to 40 in·lb).

*4 Terminals - and +1 have two screws. The Recommended Gauge is the wire gauge for one terminal.

*5 A junction terminal is necessary to connect a braking unit (CDBR-series) to terminals - and +3.

Three-Phase 400 V Class

Model	Terminal	Recommended Gauge AWG, kcmil	Applicable Gauge (IP20 Applicable Gauge ^{*1}) AWG, kcmil	Wire Stripping Length ^{*2} mm	Terminal Screw		Tightening Torque N·m (in·lb)
					Size	Shape	
4002	R/L1, S/L2, T/L3	14	14 - 6 (14 - 6)	10	M4	Slotted (-)	1.5 - 1.7 (13.5 - 15)
	U/T1, V/T2, W/T3	14	14 - 6 (14 - 6)	10	M4	Slotted (-)	1.5 - 1.7 (13.5 - 15)
	-, +1, +2	14	14 - 3 (14 - 3)	18	M5	Slotted (-)	2.3 - 2.5 (19.8 - 22) ^{*3}
	B1, B2	14	14 - 10 (14 - 10)	10	M4	Slotted (-)	1.5 - 1.7 (13.5 - 15)
	⊕	12	14 - 8 (-)	-	M4	Phillips/slotted combo	1.2 - 1.5 (10.6 - 13.3)
4004	R/L1, S/L2, T/L3	14	14 - 6 (14 - 6)	10	M4	Slotted (-)	1.5 - 1.7 (13.5 - 15)
	U/T1, V/T2, W/T3	14	14 - 6 (14 - 6)	10	M4	Slotted (-)	1.5 - 1.7 (13.5 - 15)
	-, +1, +2	14	14 - 3 (14 - 3)	18	M5	Slotted (-)	2.3 - 2.5 (19.8 - 22) ^{*3}
	B1, B2	14	14 - 10 (14 - 10)	10	M4	Slotted (-)	1.5 - 1.7 (13.5 - 15)
	⊕	12	14 - 8 (-)	-	M4	Phillips/slotted combo	1.2 - 1.5 (10.6 - 13.3)
4005	R/L1, S/L2, T/L3	14	14 - 6 (14 - 6)	10	M4	Slotted (-)	1.5 - 1.7 (13.5 - 15)
	U/T1, V/T2, W/T3	14	14 - 6 (14 - 6)	10	M4	Slotted (-)	1.5 - 1.7 (13.5 - 15)
	-, +1, +2	14	14 - 3 (14 - 3)	18	M5	Slotted (-)	2.3 - 2.5 (19.8 - 22) ^{*3}
	B1, B2	14	14 - 10 (14 - 10)	10	M4	Slotted (-)	1.5 - 1.7 (13.5 - 15)
	⊕	10	14 - 8 (-)	-	M4	Phillips/slotted combo	1.2 - 1.5 (10.6 - 13.3)
4007	R/L1, S/L2, T/L3	14	14 - 6 (14 - 6)	10	M4	Slotted (-)	1.5 - 1.7 (13.5 - 15)
	U/T1, V/T2, W/T3	14	14 - 6 (14 - 6)	10	M4	Slotted (-)	1.5 - 1.7 (13.5 - 15)
	-, +1, +2	14	14 - 3 (14 - 3)	18	M5	Slotted (-)	2.3 - 2.5 (19.8 - 22) ^{*3}
	B1, B2	14	14 - 10 (14 - 10)	10	M4	Slotted (-)	1.5 - 1.7 (13.5 - 15)
	⊕	10	14 - 8 (-)	-	M4	Phillips/slotted combo	1.2 - 1.5 (10.6 - 13.3)

Model	Terminal	Recommended Gauge AWG, kcmil	Applicable Gauge (IP20 Applicable Gauge *) AWG, kcmil	Wire Stripping Length *2 mm	Terminal Screw		Tightening Torque N·m (in·lb)
					Size	Shape	
4009	R/L1, S/L2, T/L3	14	14 - 6 (14 - 6)	10	M4	Slotted (-)	1.5 - 1.7 (13.5 - 15)
	U/T1, V/T2, W/T3	14	14 - 6 (14 - 6)	10	M4	Slotted (-)	1.5 - 1.7 (13.5 - 15)
	-, +1, +2	12	14 - 3 (14 - 3)	18	M5	Slotted (-)	2.3 - 2.5 (19.8 - 22) *3
	B1, B2	14	14 - 10 (14 - 10)	10	M4	Slotted (-)	1.5 - 1.7 (13.5 - 15)
	⊕	10	14 - 8 (-)	-	M4	Phillips/slotted combo	1.2 - 1.5 (10.6 - 13.3)
4012	R/L1, S/L2, T/L3	12	14 - 6 (14 - 6)	10	M4	Slotted (-)	1.5 - 1.7 (13.5 - 15)
	U/T1, V/T2, W/T3	14	14 - 6 (14 - 6)	10	M4	Slotted (-)	1.5 - 1.7 (13.5 - 15)
	-, +1, +2	10	14 - 3 (14 - 3)	18	M5	Slotted (-)	2.3 - 2.5 (19.8 - 22) *3
	B1, B2	14	14 - 10 (14 - 10)	10	M4	Slotted (-)	1.5 - 1.7 (13.5 - 15)
	⊕	10	14 - 8 (-)	-	M4	Phillips/slotted combo	1.2 - 1.5 (10.6 - 13.3)
4018	R/L1, S/L2, T/L3	10	14 - 6 (14 - 6)	10	M4	Slotted (-)	1.5 - 1.7 (13.5 - 15)
	U/T1, V/T2, W/T3	10	14 - 6 (14 - 6)	10	M4	Slotted (-)	1.5 - 1.7 (13.5 - 15)
	-, +1, +2	8	14 - 3 (14 - 3)	18	M5	Slotted (-)	2.3 - 2.5 (19.8 - 22) *3
	B1, B2	14	14 - 10 (14 - 10)	10	M4	Slotted (-)	1.5 - 1.7 (13.5 - 15)
	⊕	10	14 - 8 (-)	-	M5	Phillips/slotted combo	2.0 - 2.5 (17.7 - 22.1)
4023	R/L1, S/L2, T/L3	8	14 - 6 (14 - 6)	10	M4	Slotted (-)	1.5 - 1.7 (13.5 - 15)
	U/T1, V/T2, W/T3	10	14 - 6 (14 - 6)	10	M4	Slotted (-)	1.5 - 1.7 (13.5 - 15)
	-, +1, +2	8	14 - 3 (14 - 3)	18	M5	Slotted (-)	2.3 - 2.5 (19.8 - 22) *3
	B1, B2	12	14 - 10 (14 - 10)	10	M4	Slotted (-)	1.5 - 1.7 (13.5 - 15)
	⊕	10	12 - 8 (-)	-	M5	Phillips/slotted combo	2.0 - 2.5 (17.7 - 22.1)
4031	R/L1, S/L2, T/L3	6	14 - 3 (8 - 3)	18	M5	Slotted (-)	2.3 - 2.5 (19.8 - 22) *3
	U/T1, V/T2, W/T3	8	14 - 4 (10 - 4)	18	M5	Slotted (-)	2.3 - 2.5 (19.8 - 22) *3
	-, +1, +2	6	14 - 1 (8 - 1)	20	M6	Hex socket cap (WAF: 5 mm)	5 - 5.5 (45 - 49)
	B1, B2	10	14 - 8 (14 - 8)	10	M4	Slotted (-)	1.5 - 1.7 (13.5 - 15)
	⊕	8	10 - 6 (-)	-	M6	Phillips/slotted combo	5.4 - 6.0 (47.8 - 53.1)

5.3 UL Standards

Model	Terminal	Recommended Gauge AWG, kcmil	Applicable Gauge (IP20 Applicable Gauge ^{*1}) AWG, kcmil	Wire Stripping Length ^{*2} mm	Terminal Screw		Tightening Torque N-m (in-lb)
					Size	Shape	
4038	R/L1, S/L2, T/L3	6	14 - 3 (8 - 3)	18	M5	Slotted (-)	2.3 - 2.5 (19.8 - 22) ^{*3}
	U/T1, V/T2, W/T3	8	14 - 4 (10 - 4)	18	M5	Slotted (-)	2.3 - 2.5 (19.8 - 22) ^{*3}
	-, +1, +2	4	14 - 1 (8 - 1)	20	M6	Hex socket cap (WAF: 5 mm)	5 - 5.5 (45 - 49)
	B1, B2	10	14 - 8 (14 - 8)	10	M4	Slotted (-)	1.5 - 1.7 (13.5 - 15)
	⊕	6	10 - 6 (-)	-	M6	Phillips/slotted combo	5.4 - 6.0 (47.8 - 53.1)
4044	R/L1, S/L2, T/L3	4	14 - 4 (10 - 4)	18	M5	Slotted (-)	2.3 - 2.5 (19.8 - 22) ^{*3}
	U/T1, V/T2, W/T3	6	14 - 6 (10 - 6)	18	M5	Slotted (-)	2.3 - 2.5 (19.8 - 22) ^{*3}
	-, +1, +2	3	14 - 3 (10 - 3)	18	M5	Slotted (-)	2.3 - 2.5 (19.8 - 22) ^{*3}
	B1, B2	8	14 - 8 (14 - 8)	10	M4	Slotted (-)	1.5 - 1.7 (13.5 - 15)
	⊕	6	8 - 4 (-)	-	M6	Phillips/slotted combo	5.4 - 6.0 (47.8 - 53.1)
4060	R/L1, S/L2, T/L3	4	14 - 4 (10 - 4)	18	M5	Slotted (-)	2.3 - 2.5 (19.8 - 22) ^{*3}
	U/T1, V/T2, W/T3	4	14 - 4 (10 - 4)	18	M5	Slotted (-)	2.3 - 2.5 (19.8 - 22) ^{*3}
	-, +1	3	14 - 3 (10 - 3)	18	M5	Slotted (-)	2.3 - 2.5 (19.8 - 22) ^{*3}
	B1, B2	8	14 - 8 (14 - 8)	10	M4	Slotted (-)	1.5 - 1.7 (13.5 - 15)
	⊕	6	8 - 4 (-)	-	M6	Phillips/slotted combo	5.4 - 6.0 (47.8 - 53.1)
4075	R/L1, S/L2, T/L3	3	14 - 3 (12 - 3)	18	M5	Slotted (-)	2.3 - 2.5 (19.8 - 22) ^{*3}
	U/T1, V/T2, W/T3	3	14 - 3 (12 - 3)	18	M5	Slotted (-)	2.3 - 2.5 (19.8 - 22) ^{*3}
	-, +1	2	14 - 2 (10 - 2)	18	M5	Slotted (-)	2.3 - 2.5 (19.8 - 22) ^{*3}
	B1, B2	6	14 - 6 (14 - 6)	10	M4	Slotted (-)	1.5 - 1.7 (13.5 - 15)
	⊕	6	6 - 4 (-)	-	M6	Hex bolt (+)	5.4 - 6.0 (47.8 - 53.1)
4089	R/L1, S/L2, T/L3	2	14 - 2 (10 - 2)	18	M5	Slotted (-)	2.3 - 2.5 (19.8 - 22) ^{*3}
	U/T1, V/T2, W/T3	2	14 - 2 (10 - 2)	18	M5	Slotted (-)	2.3 - 2.5 (19.8 - 22) ^{*3}
	-, +1	1/0	14 - 1/0 (6 - 1/0)	20	M6	Hex socket cap (WAF: 5 mm)	5 - 5.5 (45 - 49)
	B1, B2	6	14 - 6 (14 - 6)	18	M5	Slotted (-)	2.3 - 2.5 (19.8 - 22) ^{*3}
	⊕	4	6 - 4 (-)	-	M6	Hex bolt (+)	5.4 - 6.0 (47.8 - 53.1)

Model	Terminal	Recommended Gauge AWG, kcmil	Applicable Gauge (IP20 Applicable Gauge *) AWG, kcmil	Wire Stripping Length *2 mm	Terminal Screw		Tightening Torque N·m (in·lb)
					Size	Shape	
4103	R/L1, S/L2, T/L3	1/0	6 - 2/0 (2 - 2/0)	27	M6	Hex socket cap (WAF: 5 mm)	8 - 9 (71 - 80)
	U/T1, V/T2, W/T3	1	6 - 2/0 (2 - 2/0)	27	M6	Hex socket cap (WAF: 5 mm)	8 - 9 (71 - 80)
	-, +1	2/0	2 - 4/0 (2 - 4/0)	27	M8	Hex socket cap (WAF: 6 mm)	10 - 12 (89 - 107)
	B1, B2	3	14 - 3 (10 - 3)	21	M6	Slotted (-)	3 - 3.5 (27 - 31)
	⊕	4	6 - 4 (-)	-	M6	Hex bolt (+)	5.4 - 6.0 (47.8 - 53.1)
4140	R/L1, S/L2, T/L3	3/0	2 - 250 (2/0 - 250)	37	M10	Hex socket cap (WAF: 8 mm)	12 - 14 (107 - 124)
	U/T1, V/T2, W/T3	2/0	2 - 300 (3/0 - 300)	37	M10	Hex socket cap (WAF: 8 mm)	12 - 14 (107 - 124)
	-, -, +1, +1 *4	2	6 - 2/0 (1/0 - 2/0)	28	M6	Hex socket cap (WAF: 5 mm)	8 - 9 (71 - 80)
	B1, B2 *5	1	4 - 2/0 (1 - 2/0)	28	M8	Hex socket cap (WAF: 6 mm)	8 - 9 (71 - 80)
	⊕	4	4 - 1/0 (-)	-	M8	Hex bolt (slotted)	9.0 - 11 (79.7 - 97.4)
4168	R/L1, S/L2, T/L3	4/0	2 - 250 (2/0 - 250)	37	M10	Hex socket cap (WAF: 8 mm)	12 - 14 (107 - 124)
	U/T1, V/T2, W/T3	4/0	2 - 300 (3/0 - 300)	37	M10	Hex socket cap (WAF: 8 mm)	12 - 14 (107 - 124)
	-, -, +1, +1 *4	1/0	6 - 2/0 (1/0 - 2/0)	28	M6	Hex socket cap (WAF: 5 mm)	8 - 9 (71 - 80)
	B1, B2 *5	1/0	4 - 2/0 (1 - 2/0)	28	M8	Hex socket cap (WAF: 6 mm)	8 - 9 (71 - 80)
	⊕	4	4 - 1/0 (-)	-	M8	Hex bolt (slotted)	9.0 - 11 (79.7 - 97.4)
4208	R/L1, S/L2, T/L3	1/0 × 2P	3 - 4/0 × 2P (2/0 - 4/0 × 2P)	-	M10	Hex self-locking nut	20 (177)
	U/T1, V/T2, W/T3	1/0 × 2P	3 - 4/0 × 2P (2/0 - 4/0 × 2P)	-	M10	Hex self-locking nut	20 (177)
	-, +1	3/0 × 2P	2 - 250 × 2P (4/0 - 250 × 2P)	-	M10	Hex self-locking nut	20 (177)
	+3	1/0 × 2P	4 - 1/0 × 2P (1/0 × 2P)	-	M10	Hex self-locking nut	20 (177)
	⊕	4	4 - 350 (-)	-	M10	Hex bolt (slotted)	18 - 23 (159 - 204)
4250	R/L1, S/L2, T/L3	2/0 × 2P	3 - 4/0 × 2P (2/0 - 4/0 × 2P)	-	M10	Hex self-locking nut	20 (177)
	U/T1, V/T2, W/T3	2/0 × 2P	3 - 4/0 × 2P (2/0 - 4/0 × 2P)	-	M10	Hex self-locking nut	20 (177)
	-, +1	3/0 × 2P	2 - 250 × 2P (4/0 - 250 × 2P)	-	M10	Hex self-locking nut	20 (177)
	+3	1/0 × 2P	4 - 1/0 × 2P (1/0 × 2P)	-	M10	Hex self-locking nut	20 (177)
	⊕	2	2 - 350 (-)	-	M10	Hex bolt (slotted)	18 - 23 (159 - 204)

5.3 UL Standards

Model	Terminal	Recommended Gauge AWG, kcmil	Applicable Gauge (IP20 Applicable Gauge *) AWG, kcmil	Wire Stripping Length *2 mm	Terminal Screw		Tightening Torque N-m (in-lb)
					Size	Shape	
4302	R/L1, S/L2, T/L3	3/0 × 2P	3 - 4/0 × 2P (2/0 - 4/0 × 2P)	-	M10	Hex self-locking nut	20 (177)
	U/T1, V/T2, W/T3	3/0 × 2P	3 - 4/0 × 2P (2/0 - 4/0 × 2P)	-	M10	Hex self-locking nut	20 (177)
	-, +1	4/0 × 2P	2 - 250 × 2P (4/0 - 250 × 2P)	-	M10	Hex self-locking nut	20 (177)
	+3	1/0 × 2P	4 - 1/0 × 2P (1/0 × 2P)	-	M10	Hex self-locking nut	20 (177)
	⊕	2	2 - 350 (-)	-	M10	Hex bolt (slotted)	18 - 23 (159 - 204)
4371	R/L1, S/L2, T/L3	250 × 2P	2/0 - 300 × 2P (250 - 300 × 2P)	-	M12	Hex self-locking nut	35 (310)
	U/T1, V/T2, W/T3	250 × 2P	2/0 - 300 × 2P (250 - 300 × 2P)	-	M12	Hex self-locking nut	35 (310)
	-, +1	350 × 2P	4/0 - 400 × 2P (300 - 400 × 2P)	-	M12	Hex self-locking nut	35 (310)
	+3	3/0 × 2P	1 - 4/0 × 2P (-)	-	M12	Hex self-locking nut	35 (310)
	⊕	1	1 - 350 (-)	-	M12	Hex bolt (slotted)	32 - 40 (283 - 354)
4414	R/L1, S/L2, T/L3	300 × 2P	2/0 - 300 × 2P (250 - 300 × 2P)	-	M12	Hex self-locking nut	35 (310)
	U/T1, V/T2, W/T3	300 × 2P	2/0 - 300 × 2P (250 - 300 × 2P)	-	M12	Hex self-locking nut	35 (310)
	-, +1	400 × 2P	4/0 - 400 × 2P (300 - 400 × 2P)	-	M12	Hex self-locking nut	35 (310)
	+3	4/0 × 2P	1 - 4/0 × 2P (-)	-	M12	Hex self-locking nut	35 (310)
	⊕	1	1 - 350 (-)	-	M12	Hex bolt (slotted)	32 - 40 (283 - 354)
4477	R/L1, S/L2, T/L3	250 × 4P	2/0 - 300 × 4P (250 - 300 × 4P)	-	M12	Hex self-locking nut	35 (310)
	U/T1, V/T2, W/T3	4/0 × 4P	2/0 - 300 × 4P (250 - 300 × 4P)	-	M12	Hex self-locking nut	35 (310)
	-, +1	4/0 × 4P	3/0 - 400 × 4P (300 - 400 × 4P)	-	M12	Hex self-locking nut	35 (310)
	+3	3/0 × 4P	2 - 4/0 (4/0 × 4P)	-	M12	Hex self-locking nut	35 (310)
	⊕	1/0	1/0 - 300 (-)	-	M12	Hex bolt (slotted)	32 - 40 (283 - 354)
4568	R/L1, S/L2, T/L3	250 × 4P	2/0 - 300 × 4P (250 - 300 × 4P)	-	M12	Hex self-locking nut	35 (310)
	U/T1, V/T2, W/T3	4/0 × 4P	2/0 - 300 × 4P (250 - 300 × 4P)	-	M12	Hex self-locking nut	35 (310)
	-, +1	300 × 4P	3/0 - 400 × 4P (300 - 400 × 4P)	-	M12	Hex self-locking nut	35 (310)
	+3	3/0 × 4P	2 - 4/0 × 4P (4/0 × 4P)	-	M12	Hex self-locking nut	35 (310)
	⊕	2/0	2/0 - 300 (-)	-	M12	Hex bolt (slotted)	32 - 40 (283 - 354)

Model	Terminal	Recommended Gauge AWG, kcmil	Applicable Gauge (IP20 Applicable Gauge ^{*1}) AWG, kcmil	Wire Stripping Length ^{*2} mm	Terminal Screw		Tightening Torque N·m (in·lb)
					Size	Shape	
4605	R/L1, S/L2, T/L3	300 × 4P	2/0 - 300 × 4P (250 - 300 × 4P)	-	M12	Hex self-locking nut	35 (310)
	U/T1, V/T2, W/T3	300 × 4P	2/0 - 300 × 4P (250 - 300 × 4P)	-	M12	Hex self-locking nut	35 (310)
	-, +1	400 × 4P	3/0 - 400 × 4P (300 - 400 × 4P)	-	M12	Hex self-locking nut	35 (310)
	+3	4/0 × 4P	2 - 4/0 × 4P (4/0 × 4P)	-	M12	Hex self-locking nut	35 (310)
	⊕	2/0	2/0 - 300 (-)	-	M12	Hex bolt (slotted)	32 - 40 (283 - 354)
4720	R/L1, S/L2, T/L3	300 × 4P	2/0 - 300 × 4P (250 - 300 × 4P)	-	M12	Hex self-locking nut	35 (310)
	U/T1, V/T2, W/T3	300 × 4P	2/0 - 300 × 4P (250 - 300 × 4P)	-	M12	Hex self-locking nut	35 (310)
	-, +1	400 × 4P	3/0 - 400 × 4P (300 - 400 × 4P)	-	M12	Hex self-locking nut	35 (310)
	+3	4/0 × 4P	2 - 4/0 × 4P (4/0 × 4P)	-	M12	Hex self-locking nut	35 (310)
	⊕	2/0	2/0 - 300 (-)	-	M12	Hex bolt (slotted)	32 - 40 (283 - 354)

*1 For IP20 protection, use wires that are in the range of applicable gauges.

*2 Remove insulation from the ends of wires to expose the length of wire shown.

*3 For wire gauges more than AWG 8, tighten to a tightening torque of 4.1 N·m to 4.5 N·m (36 in·lb to 40 in·lb).

*4 Terminals - and +1 have two screws. The Recommended Gauge is the wire gauge for one terminal.

*5 A junction terminal is necessary to connect a braking resistor unit (LKEB-series) to terminals B1 and B2.

■ Closed-Loop Crimp Terminals

To comply with UL standards on drive models 2257 to 2415 and 4208 to 4720, use UL Listed closed-loop crimp terminals and heat-shrinkable tubing. Use the tools recommend by the terminal manufacturer to crimp the closed-loop crimp terminal. Yaskawa recommends closed-loop crimp terminals and heat-shrinkable tubing from PANDUIT Corp.

Comply with local standards for correct wire gauges in the region where the drive is used.

Use the tools recommended by PANDUIT Corp. to crimp the closed-loop terminals.

Refer to [Table 5.12](#) to select crimp terminals as specified by drive model and wire gauge.

Note:

To comply with UL standards, use only insulated crimp terminals or crimp terminals with insulation tubing. Use UL Listed vinyl-coated insulated copper wires for operation with a continuous maximum permitted temperature of 75 °C at 600 V.

Table 5.12 Closed-Loop Crimp Terminals (Manufacturer: PANDUIT Corp.)

Model	Recommended Gauge (AWG, kcmil)					Crimp Terminal Part Number ^{*1}
	R/L1 S/L2 T/L3	U/T1 V/T2 W/T3	-, +1	+3	⊕	
2004 - 2021	-	-	-	-	10	P10-8R-L
2030, 2042	-	-	-	-	8	P8-10R-Q S8-10R-Q
2056	-	-	-	-	6	P6-14R-E S6-10R-E
2070 - 2110	-	-	-	-	6	P6-14R-E S6-10R-E
2138	-	-	-	-	4	P4-14R-E S4-56R-E

5.3 UL Standards

Model	Recommended Gauge (AWG, kcmil)					Crimp Terminal Part Number */
	R/L1 S/L2 T/L3	U/T1 V/T2 W/T3	-, +1	+3	⊕	
2169, 2211	-	-	-	-	4	P4-56R-E S4-56R-E
2257	-	-	-	-	3	S2-38R-X
	-	-	-	1/0 × 2P	-	S1/0-38R-X
	2/0 × 2P	2/0 × 2P	-	-	-	S2/0-38R-X
	-	-	4/0 × 2P	-	-	S4/0-38R-5
2313	-	-	-	-	2	S2-38R-X
	-	-	-	1/0 × 2P	-	S1/0-38R-X
	-	3/0 × 2P	-	-	-	S3/0-38R-5
	4/0 × 2P	-	-	-	-	S4/0-38R-5
	-	-	250 × 2P	-	-	S250-38R-5
2360	-	-	-	-	1	S2-12R-X
	-	-	-	3/0 × 2P	-	S3/0-12R-5
	250 × 2P	250 × 2P	-	-	-	S250-12R-5
	-	-	350 × 2P	-	-	LCA350-12-X LCAX350-12-6
2415	-	-	-	-	1	S2-12R-X
	-	-	-	3/0 × 2P	-	S3/0-12R-5
	250 × 2P	-	-	-	-	S250-12R-5
	-	300 × 2P	-	-	-	LCA300-12-X LCAX300-12-6
	-	-	350 × 2P	-	-	LCA350-12-X LCAX350-12-6
4002, 4004	-	-	-	-	12	P10-8R-L
4005 - 4012	-	-	-	-	10	P10-8R-L
4018, 4023	-	-	-	-	10	P10-10R-L
4031	-	-	-	-	8	P8-14R-Q S8-14R-Q
4038	-	-	-	-	6	P6-14R-E S6-14R-E
4044, 4060	-	-	-	-	6	P6-14R-E S6-14R-E
4075	-	-	-	-	6	P6-14R-E S6-14R-E
4089, 4103	-	-	-	-	4	P4-14R-E S4-14R-E
4140, 4168	-	-	-	-	4	P4-56R-E S4-56R-E
4208	-	-	-	-	4	P4-38R-E S4-38R-E
	1/0 × 2P	1/0 × 2P	-	1/0 × 2P	-	S1/0-38R-X
	-	-	3/0 × 2P	-	-	S3/0-38R-5

Model	Recommended Gauge (AWG, kcmil)					Crimp Terminal Part Number *1
	R/L1 S/L2 T/L3	U/T1 V/T2 W/T3	-, +1	+3	⊕	
4250	-	-	-	-	2	P2-38R-X S2-38R-X
	-	-	-	1/0 × 2P	-	S1/0-38R-X
	2/0 × 2P	2/0 × 2P	-	-	-	S2/0-38R-X
	-	-	3/0 × 2P	-	-	S3/0-38R-5
4302	-	-	-	-	2	P2-38R-X S2-38R-X
	-	-	-	1/0 × 2P	-	S1/0-38R-X
	3/0 × 2P	3/0 × 2P	-	-	-	S3/0-38R-5
	-	-	4/0 × 2P	-	-	S4/0-38R-5
4371	-	-	-	-	1	S2-12R-X
	-	-	-	3/0 × 2P	-	S3/0-12R-5
	250 × 2P	250 × 2P	-	-	-	S250-12R-5
	-	-	350 × 2P	-	-	LCA350-12-X LCAX350-12-6
4414	-	-	-	-	1	S2-12R-X
	-	-	-	4/0 × 2P	-	S4/0-12R-5
	300 × 2P	300 × 2P	-	-	-	LCA300-12-X LCAX300-12-6
	-	-	400 × 2P	-	-	LCA400-12-6
4477	-	-	-	-	1/0	S1/0-12R-X
	-	-	-	3/0 × 4P	-	S3/0-12R-5
	-	4/0 × 4P	4/0 × 4P	-	-	S4/0-12R-5
	250 × 4P	-	-	-	-	S250-12R-5
4568	-	-	-	-	2/0	S2/0-12R-X
	-	-	-	3/0 × 4P	-	S3/0-12R-5
	-	4/0 × 4P	-	-	-	S4/0-12R-5
	250 × 4P	-	-	-	-	S250-12R-5
	-	-	300 × 4P	-	-	LCA300-12-X LCAX300-12-6
4605	-	-	-	-	2/0	S2/0-12R-X
	-	-	-	4/0 × 4P	-	S4/0-12R-5
	300 × 4P	300 × 4P	-	-	-	LCA300-12-X LCAX300-12-6
	-	-	400 × 4P	-	-	LCA400-12-6
4720	-	-	-	-	2/0	S2/0-12R-X
	-	-	-	4/0 × 4P	-	S4/0-12R-5
	300 × 4P	300 × 4P	-	-	-	LCA300-12-X LCAX300-12-6
	-	-	400 × 4P	-	-	LCA400-12-6

*1 For use with PANDUIT Corp. heat-shrinkable tubing HSTT series or an equivalent UL recognized heat-shrinkable tubing rated 600 V minimum.

■ Factory-Recommended Branch Circuit Protection

Use branch circuit protection to protect against short circuits and to maintain compliance with UL 508C. Yaskawa recommends connecting semiconductor protection fuses on the input side for branch circuit protection. Refer to for the recommended fuses.

200 V Class

Table 5.13 Factory Recommended Fuses for 200 V Class

Drive Model	Semiconductor Fuse Manufacturer: EATON/Bussmann	Alternate Time-Delay Class CC, J, or T ^{*1} Maximum Amp Rating (Maximum SCCR (kA))
2004	FWH-45B	6 (65)
2006	FWH-45B	10 (65)
2008	FWH-45B	12 (65)
2010	FWH-45B	15 (65)
2012	FWH-50B FWH-80B ^{*2}	20 (65)
2018	FWH-80B FWH-100B ^{*2}	30 (65)
2021	FWH-80B FWH-100B ^{*2}	35 (65)
2030	FWH-125B	50 (100)
2042	FWH-150B	70 (100)
2056	FWH-200B	90 (100)
2070	FWH-225A	110 (100)
2082	FWH-225A FWH-250A ^{*2}	125 (100)
2110	FWH-225A FWH-250A ^{*2}	175 (100)
2138	FWH-275A FWH-300A ^{*2}	225 (100)
2169	FWH-275A FWH-350A ^{*2}	250 (100)
2211	FWH-325A FWH-450A ^{*2}	350 (100)
2257	FWH-600A	400 (100)
2313	FWH-800A	500 (100)
2360	FWH-1000A	600 (100) ^{*3}
2415	FWH-1000A	800 (100) ^{*3}

*1 Class T fuses are fast-acting (non-time delay only).

*2 Yaskawa recommends a fuse with a larger rated current for cyclical load applications that frequently approach 150 % overload.

*3 For fuses rated 601 - 800 amps, you must use Class T fuses.

400 V Class

Table 5.14 Factory Recommended Fuses for 400 V Class

Drive Model	Semiconductor Fuse Manufacturer: EATON/Bussmann	Alternate Time-Delay Class CC, J, or T ^{*1} Maximum Amp Rating (Maximum SCCR (kA))
4002	FWH-50B	3.5 (100)
4004	FWH-50B	7 (100)
4005	FWH-50B	9 (100)

Drive Model	Semiconductor Fuse Manufacturer: EATON/Bussmann	Alternate Time-Delay Class CC, J, or T ^{*1} Maximum Amp Rating (Maximum SCCR (kA))
4007	FWH-60B	12 (100)
4009	FWH-60B	15 (100)
4012	FWH-60B	20 (100)
4018	FWH-80B	30 (100)
4023	FWH-90B	40 (100)
4031	FWH-150B	50 (100)
4038	FWH-200B	60 (100)
4044	FWH-200B	70 (100)
4060	FWH-225A	100 (100)
4075	FWH-250A	125 (100)
4089	FWH-275A	150 (100)
4103	FWH-275A	175 (100)
4140	FWH-300A	225 (100)
4168	FWH-325A FWH-400A ^{*2}	250 (100)
4208	FWH-500A	350 (100)
4250	FWH-600A	400 (100)
4302	FWH-700A	500 (100)
4371	FWH-800A	Not applicable
4414	FWH-1000A	Not applicable
4477	FWH-1200A	Not applicable
4568	FWH-1200A	Not applicable
4605	FWH-1400A	Not applicable
4720	FWH-1400A	Not applicable

*1 Class T fuses are fast-acting (non-time delay only).

*2 Yaskawa recommends a fuse with a larger rated current for cyclical load applications that frequently approach 150 % overload.

◆ UL Standards Compliance for DC Power Supply Input

To comply with UL Standards, install a fuse for the DC power supply input.

Figure 5.11 shows a wiring example for a DC power supply that has two drives connected in parallel.

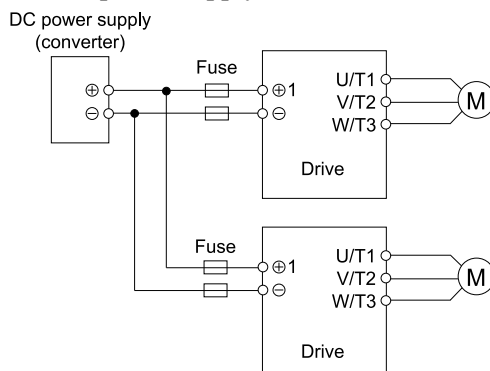

Figure 5.11 Wiring Example for DC Power Supply Input

WARNING! Electrical Shock Hazard. Do not ground the main circuit bus. Incorrect wiring can cause serious injury or death.

5.3 UL Standards

Note:

- Install a fuse for each drive when operating more than one drive. If one fuse opens, replace all fuses.

Refer to [Table 5.15](#) and [Table 5.16](#) for the recommended fuses.

Table 5.15 Recommended DC Input Fuse (Three-Phase 200 V Class)

Drive Model	Fuse Manufacturer: Bussmann	
	Model	Quantity
2004	FWH-45B	2
2006		
2008		
2010		
2012	FWH-50B, or FWH-80B <i>*1</i> , or FWH-100B <i>*1</i>	2
2018	FWH-80B, or FWH-100B <i>*1</i>	2
2021		
2030	FWH-125B	2
2042	FWH-150B	2
2056	FWH-200B	2
2070	FWH-225A	2
2082	FWH-250A	2
2110		
2138	FWH-300A	2
2169	FWH-350A	2
2211	FWH-450A	2
2257	FWH-600A	2
2313	FWH-800A	2
2360	FWH-1000A	2
2415		

*1 Yaskawa recommends a fuse with a larger rated current for cyclic load applications that frequently approach 150% overload.

Table 5.16 Recommended DC Input Fuse (Three-Phase 400 V Class)

Drive Model	Fuse Manufacturer: Bussmann	
	Model	Quantity
4002	FWP-50B	2
4004		
4005		
4007	FWP-60B	2
4009		
4012		
4018	FWP-80B	2
4023	FWP-90B	2
4031	FWP-150A	2
4038	FWP-200A	2
4044		
4060	FWP-225A	2
4075	FWP-250A	2

Drive Model	Fuse Manufacturer: Bussmann	
	Model	Quantity
4089	FWP-300A	2
4103		
4140	FWP-350A	2
4168	FWP-450A	2
4208	FWP-600A	2
4250	FWP-700A	2
4302	FWP-800A	2
4371	Not applicable	
4414		
4477		
4568		
4605		
4720		

◆ Low Voltage Wiring for Control Circuit Terminals

You must provide low voltage wiring as specified by the National Electric Code (NEC), the Canadian Electric Code, Part I (CEC), and local codes. Yaskawa recommends the NEC class 1 circuit conductor. Use the UL approved class 2 power supply for external power supply.

Table 5.17 Control Circuit Terminal Power Supplies

Input/Output	Terminals	Power Supply Specifications
Digital input	S1 to S8, SN, SC, SP	Uses the LVLC power supply in the drive. Use the UL Listed class 2 power supply for external power supply.
Analog input	A1 to A3, AC, +V, -V	Uses the LVLC power supply in the drive. Use the UL Listed class 2 power supply for external power supply.
Analog output	FM, AM, AC	Uses the LVLC power supply in the drive.
Pulse train output	MP, AC	Uses the LVLC power supply in the drive. Use the UL Listed class 2 power supply for external power supply.
Pulse train input	RP, AC	Uses the LVLC power supply in the drive. Use the UL Listed class 2 power supply for external power supply.
Safe disable input	H1, H2, HC	Uses the LVLC power supply in the drive. Use the UL Listed class 2 power supply for external power supply.
Serial communication input/output	D+, D-, AC	Uses the LVLC power supply in the drive. Use the UL Listed class 2 power supply for external power supply.
24 V external power supply	PS, AC	Use the UL Listed class 2 power supply.

◆ Drive Motor Overload and Overheat Protection

The drive motor overload and overheat protection function complies with the National Electric Code (NEC) and the Canadian Electric Code, Part I (CEC).

Set the Motor Rated Current and *L1-01 through L1-04 [Motor Overload Protection Select]* correctly to enable motor overload and overheat protection.

Refer to the control method and set the motor rated current with *E2-01 [Motor Rated Current (FLA)]*, *E5-03 [PM Motor Rated Current (FLA)]*, or *E9-06 [Motor Rated Current (FLA)]*.

■ E2-01: Motor Rated Current (FLA)

No. (Hex.)	Name	Description	Default (Range)
E2-01 (030E)	Motor Rated Current (FLA)	<input type="checkbox"/> V/f <input type="checkbox"/> CL-V/f <input type="checkbox"/> OLV <input type="checkbox"/> CLV <input type="checkbox"/> AOLV <input type="checkbox"/> OLV/PM <input type="checkbox"/> AOLV/PM <input type="checkbox"/> CLV/PM <input type="checkbox"/> EZOLV Sets the motor rated current in amps.	Determined by o2-04, C6-01 (10% to 200% of the drive rated current)

Note:

- If $E2-01 < E2-03$ [Motor No-Load Current], the drive will detect $oPE02$ [Parameter Range Setting Error].
- When the drive model changes, the display units for this parameter also change.
 - 0.01 A: models 2004 to 2042, 4002 to 4023
 - 0.1 A: models 2056 to 2415, 4031 to 4720

The value set for $E2-01$ becomes the reference value for motor protection, the torque limit, and torque control. Enter the motor rated current shown on the motor nameplate. Auto-Tuning the drive will automatically set $E2-01$ to the value input for “Motor Rated Current”.

■ E5-03: PM Motor Rated Current (FLA)

No. (Hex.)	Name	Description	Default (Range)
E5-03 (032B)	PM Motor Rated Current (FLA)	<input type="checkbox"/> V/f <input type="checkbox"/> CL-V/f <input type="checkbox"/> OLV <input type="checkbox"/> CLV <input type="checkbox"/> AOLV <input checked="" type="checkbox"/> OLV/PM <input checked="" type="checkbox"/> AOLV/PM <input checked="" type="checkbox"/> CLV/PM <input type="checkbox"/> EZOLV Sets the PM motor rated current (FLA).	Determined by o2-04, C6-01 (10% to 200% of the drive rated current)

Note:

- When the drive model changes, the display units for this parameter also change.
- 0.01 A: models 2004 to 2042, 4002 to 4023
 - 0.1 A: models 2056 to 2415, 4031 to 4720

After you do these types of Auto-Tuning, the drive automatically will set $E5-03$ to the value input for “PM Motor Rated Current”:

- PM Motor Parameter Settings
- PM Stationary Auto-Tuning
- PM StaTun for Stator Resistance
- PM Rotational Auto-Tuning

■ E9-06: Motor Rated Current (FLA)

No. (Hex.)	Name	Description	Default (Range)
E9-06 (11E9)	Motor Rated Current (FLA)	<input type="checkbox"/> V/f <input type="checkbox"/> CL-V/f <input type="checkbox"/> OLV <input type="checkbox"/> CLV <input type="checkbox"/> AOLV <input type="checkbox"/> OLV/PM <input type="checkbox"/> AOLV/PM <input type="checkbox"/> CLV/PM <input checked="" type="checkbox"/> EZOLV Sets the motor rated current in amps.	Determined by E9-01 and o2-04 (10% to 200% of the drive rated current)

Note:

- When the drive model changes, the display units for this parameter also change.
- 0.01 A: models 2004 to 2042, 4002 to 4023
 - 0.1 A: models 2056 to 2415, 4031 to 4720

The value set for $E9-06$ becomes the reference value for motor protection. Enter the motor rated current shown on the motor nameplate. Auto-Tuning the drive will automatically set $E9-06$ to the value input for “Motor Rated Current”.

■ L1-01: Motor Overload (oL1) Protection

No. (Hex.)	Name	Description	Default (Range)
L1-01 (0480)	Motor Overload (oL1) Protection	<input type="checkbox"/> V/f <input type="checkbox"/> CL-V/f <input type="checkbox"/> OLV <input type="checkbox"/> CLV <input type="checkbox"/> AOLV <input type="checkbox"/> OLV/PM <input type="checkbox"/> AOLV/PM <input type="checkbox"/> CLV/PM <input checked="" type="checkbox"/> EZOLV Sets the motor overload protection with electronic thermal protectors.	Determined by A1-02 (0 - 6)

This parameter enables and disables the motor overload protection with electronic thermal protectors.

The cooling capability of the motor changes when the speed control range of the motor changes. Use an electronic thermal protector that aligns with the permitted load characteristics of the motor to select motor protection.

The electronic thermal protector of the drive uses these items to calculate motor overload tolerance and supply overload protection for the motor:

- Output Current
- Output Frequency
- Motor thermal characteristics
- Time characteristics

If the drive detects motor overload, the drive will trigger an *oL1* [Motor Overload] and stop the drive output.

Set $H2-01 = 1F$ [Term M1-M2 Function Selection = Motor Overload Alarm (oL1)] to set a motor overload alarm. If the motor overload level is more than 90% of the *oL1* detection level, the output terminal turns ON and triggers an overload alarm.

0 : Disabled

Disable motor protection when motor overload protection is not necessary or when the drive is operating more than one motor.

Refer to [Figure 5.12](#) for an example of the circuit configuration to connect more than one motor to one drive.

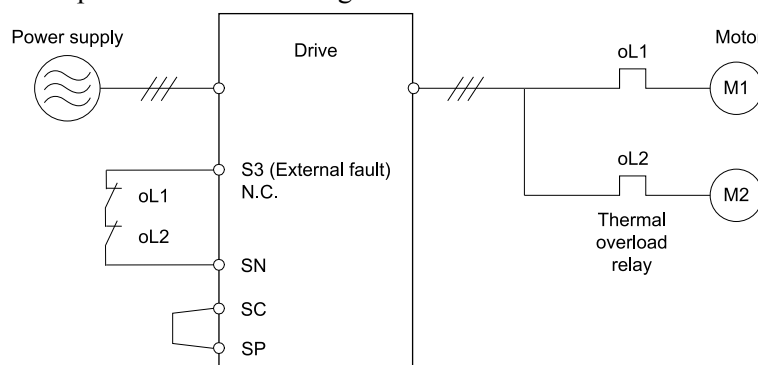

Figure 5.12 Protection Circuit Configuration to Connect More than One Motor to One Drive

NOTICE: When you connect more than one motor to one drive or when the motor amp rating is higher than the drive amp rating, set $L1-01 = 0$ [Motor Overload (oL1) Protection = Disabled] and install thermal overload relays for each motor. The electronic thermal protection of the drive will not function and it can cause damage to the motor.

1 : Variable Torque

Use this setting for general-purpose motors with a 60 Hz base frequency.

The overload tolerance decreases as motor speed decreases because the cooling fan speed decreases and the ability of the motor to cool decreases in the low speed range.

The overload tolerance characteristics of the motor change the trigger point for the electronic thermal protector. This provides motor overheat protection from low speed to high speed across the full speed range.

Load Tolerance	Cooling Capability	Overload Characteristics (at 100% motor load)
	<p>This motor is designed to operate with commercial line power. Operate at a 60 Hz base frequency to maximize the motor cooling ability.</p>	<p>If the motor operates at frequencies less than 60 Hz, the drive will detect <i>oL1</i>. The drive triggers a fault relay output and the motor coasts to stop.</p>

2 : Constant Torque 10:1 Speed Range

Use this setting for drive-dedicated motors with a speed range for constant torque of 1:10.

The speed control for this motor is 10% to 100% when at 100% load. If the motor operates at slower than 10% speed with 100% load, it will cause motor overload.

Load Tolerance	Cooling Capability	Overload Characteristics (at 100% motor load)
	<p>This motor is designed to withstand increased temperatures during continuous operation in the low speed range (10% base frequency).</p>	<p>The motor operates continuously at 10% to 100% base frequency. Operating slower than 10% speed at 100% load will cause motor overload.</p>

3 : Constant Torque 100:1 SpeedRange

Use this setting for vector motors with a speed range for constant torque of 1:100.

The speed control for this motor is 1% to 100% when at 100% load. If the motor operates at slower than 1% speed with 100% load, it will cause motor overload.

Load Tolerance	Cooling Capability	Overload Characteristics (at 100% motor load)
	<p>This motor is designed to withstand increased temperatures during continuous operation in the low speed range (1% base frequency).</p>	<p>The motor operates continuously at 1% to 100% base frequency. Operating slower than 1% speed at 100% load will cause motor overload.</p>

4 : PM Variable Torque

Use this setting for PM motors with derated torque characteristics.

The overload tolerance decreases as motor speed decreases because the cooling fan speed decreases and the ability of the motor to cool decreases in the low speed range.

The overload tolerance characteristics of the motor change the trigger point for the electronic thermal protector. This provides motor overheat protection from low speed to high speed across the full speed range.

Load Tolerance	Cooling Capability	Overload Characteristics (at 100% motor load)
	<p>This motor is designed to withstand increased temperatures during continuous operation at rated speed and rated torque.</p>	<p>If the motor operates continuously at lower speed than rated rotation speed at more than 100% torque, the drive will detect <i>o.LI</i>. The drive triggers a fault relay output and the motor coasts to stop.</p>

5 : PM Constant Torque

Use this setting with a PM motor for constant torque that has a speed range for constant torque of 1:500.

The speed control for this motor is 0.2% to 100% when at 100% load. If the motor operates at slower than 0.2% speed with 100% load, it will cause motor overload.

Load Tolerance	Cooling Capability	Overload Characteristics (at 100% motor load)
	<p>This motor is designed to withstand increased temperatures during continuous operation in the low speed range (0.2% base frequency).</p>	<p>The motor operates continuously at 0.2% to 100% rated speed. Operating slower than 0.2% speed at 100% load will cause motor overload.</p>

6 : Variable Torque (50Hz)

Use this setting for general-purpose motors with a 50 Hz base frequency.

The overload tolerance decreases as motor speed decreases because the cooling fan speed decreases and the ability of the motor to cool decreases in the low speed range.

The overload tolerance characteristics of the motor change the trigger point for the electronic thermal protector. This provides motor overheat protection from low speed to high speed across the full speed range.

Load Tolerance	Cooling Capability	Overload Characteristics (at 100% motor load)
	<p>This motor is designed to operate with commercial line power. Operate at a 50 Hz base frequency to maximize the motor cooling ability.</p>	<p>If the motor operates at frequencies less than commercial line power, the drive will detect <i>oLI</i>. The drive triggers a fault relay output and the motor coasts to stop.</p>

■ L1-02: Motor Overload Protection Time

No. (Hex.)	Name	Description	Default (Range)
L1-02 (0481)	Motor Overload Protection Time	<p>V/f CL-V/f OLV CLV AOLV OLV/PM AOLV/PM CLV/PM EZOLV</p> <p>Sets the operation time for the electronic thermal protector of the drive to prevent damage to the motor. Usually it is not necessary to change this setting.</p>	1.0 min (0.1 - 5.0 min)

Set the overload tolerance time to the length of time that the motor can operate at 150% load from continuous operation at 100% load.

When the motor operates at 150% load continuously for 1 minute after continuous operation at 100% load (hot start), the default setting triggers the electronic thermal protector.

Figure 5.13 shows an example of the electronic thermal protector operation time. Motor overload protection operates in the range between a cold start and a hot start.

This example shows a general-purpose motor operating at the base frequency with *L1-02* set to 1.0 min.

- Cold start
Shows the motor protection operation time characteristics when the overload occurs immediately after starting operation from a complete stop.

• Hot start

Shows the motor protection operation time characteristics when overload occurs from continuous operation below the motor rated current.

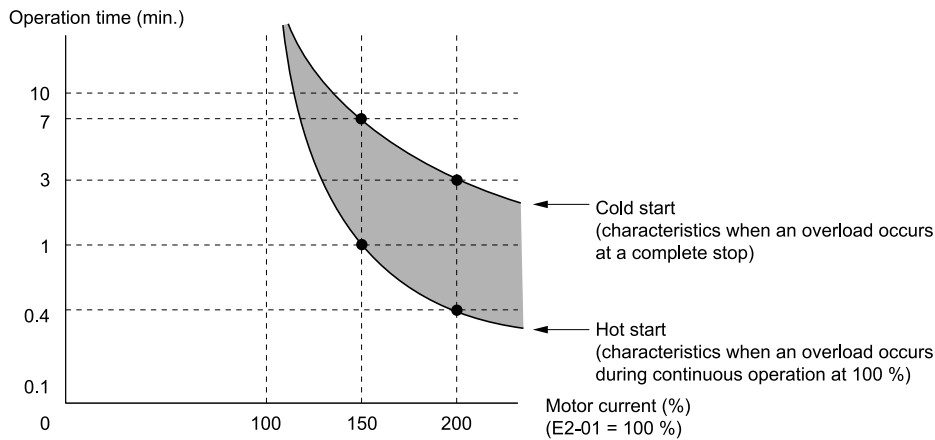

Figure 5.13 Protection Operation Time for a General-purpose Motor at Rated Output Frequency

■ L1-03: Motor Thermistor oH Alarm Select

No. (Hex.)	Name	Description	Default (Range)
L1-03 (0482)	Motor Thermistor oH Alarm Select	<input type="checkbox"/> V/f <input type="checkbox"/> CL-V/f <input type="checkbox"/> OLV <input type="checkbox"/> CLV <input type="checkbox"/> AOLV <input type="checkbox"/> OLV/PM <input type="checkbox"/> AOLV/PM <input type="checkbox"/> CLV/PM <input type="checkbox"/> EZOLV Sets drive operation when the PTC input signal entered into the drive is at the oH3 [Motor Overheat Alarm] detection level.	3 (0 - 3)

0 : Ramp to Stop

The drive ramps the motor to stop in the deceleration time. Fault relay output terminal MA-MC turns ON and MB-MC turns OFF.

1 : Coast to Stop

The output turns OFF and the motor coasts to stop. Fault relay output terminal MA-MC turns ON, and MB-MC turns OFF.

2 : Fast Stop (Use C1-09)

The drive stops the motor in the deceleration time set in C1-09 [Fast Stop Time]. Fault relay output terminal MA-MC turns ON, and MB-MC turns OFF.

3 : Alarm Only

The keypad shows oH3, and operation continues. The output terminal set for Alarm [H2-01 to H2-03 = 10] turns ON.

■ L1-04: Motor Thermistor oH Fault Select

No. (Hex.)	Name	Description	Default (Range)
L1-04 (0483)	Motor Thermistor oH Fault Select	<input type="checkbox"/> V/f <input type="checkbox"/> CL-V/f <input type="checkbox"/> OLV <input type="checkbox"/> CLV <input type="checkbox"/> AOLV <input type="checkbox"/> OLV/PM <input type="checkbox"/> AOLV/PM <input type="checkbox"/> CLV/PM <input type="checkbox"/> EZOLV Sets the drive operation when the PTC input signal to the drive is at the oH4 [Motor Overheat Fault (PTC Input)] detection level.	1 (0 - 2)

0 : Ramp to Stop

The drive ramps the motor to stop in the deceleration time. Fault relay output terminal MA-MC turns ON and MB-MC turns OFF.

1 : Coast to Stop

The output turns OFF and the motor coasts to stop. Fault relay output terminal MA-MC turns ON, and MB-MC turns OFF.

2 : Fast Stop (Use C1-09)

The drive stops the motor in the deceleration time set in C1-09 [Fast Stop Time]. Fault relay output terminal MA-MC turns ON, and MB-MC turns OFF.

5.4 对应中国RoHS指令



图 5.14 中国RoHS标志

中国RoHS标志依据2016年1月26日公布的《电器电子产品有害物质限制使用管理办法》，以及《电子电气产品有害物质限制使用标识要求》（SJ/T 11364-2014）作成。电子电气产品中特定6种有害物质的含量超过规定值时，应标识此标志。中间的数字为在中国生产销售以及进口的电子电气产品的环保使用期限（年限）。电子电气产品的环保使用期限从生产日期算起。在期限内，正常使用产品的过程中，不会有特定的6种有害物质外泄进而对环境、人和财产造成深刻影响。

本产品的环保使用期限为15年。但需要注意的是环保使用期限并非产品的质量保证期限。

◆ 本产品中含有有害物质的信息

本产品中所含有有害物质的详细信息如表 5.18 所示。

表 5.18 本产品中有害物质的名称及含量

部件名称	有害物质					
	铅 (Pb)	汞 (Hg)	镉 (Cd)	六价铬 (Cr(VI))	多溴联苯 (PBB)	多溴二苯醚 (PBDE)
实装基板	×	○	○	○	○	○
电子元件	×	○	○	○	○	○
黄铜螺钉	×	○	○	○	○	○
铝压铸	×	○	○	○	○	○

本表格依据SJ/T 11364的规定编制。
 ○：表示该有害物质在该部件所有均质材料中的含量均在GB/T 26572规定的限量要求以下。
 ×：表示该有害物质至少在该部件的某一均质材料中的含量超出GB/T 26572规定的限量要求。
 （注） 本产品符合欧盟RoHS指令。上表中的“×”表示含有欧盟RoHS指令豁免的有害物质。

5.5 China RoHS Compliance



Figure 5.15 China RoHS Mark

The China RoHS mark is displayed on products containing six specified hazardous substances that are in excess of regulatory limits, based on the “Administrative Measures for the Restriction of the Use of Hazardous Substances in Electrical and Electronic Products” and “Marking for the Restricted Use of Hazardous Substances in Electronic and Electrical Products” (SJ/T 11364-2014), which were promulgated on January 26, 2016. The number displayed in the center of the mark indicates the environment-friendly use period (number of years) in which electrical and electronic products that are being produced, sold, or imported to China can be used. The date of manufacture of the electrical and electronic product is the starting date of the environment-friendly use period for the product. The six specified hazardous substances contained in the product will not leak outside of the product during normal use within this period and will have no serious impact on the environment, the human body, or property.

The environment-friendly use period for this product is 15 years. This period is not the product warranty period.

◆ Information on Hazardous Substances in This Product

Table 5.19 shows the details on hazardous substances contained in this product.

Table 5.19 Contents of Hazardous Substances in This Product

Parts Name	Hazardous Substances					
	Lead (Pb)	Mercury (Hg)	Cadmium (Cd)	Hexavalent Chromium (Cr(VI))	Polybrominated Biphenyls (PBB)	Polybrominated Diphenyl Ethers (PBDE)
Circuit Board	×	○	○	○	○	○
Electronic Parts	×	○	○	○	○	○
Brass Screw	×	○	○	○	○	○
Aluminum Die Casting	×	○	○	○	○	○

This table has been prepared in accordance with the provisions outlined in SJ/T 11364.

○: Indicates that said hazardous substance contained in all of the homogeneous materials for this part is below or equal to the limit requirement of GB/T 26572.

×: Indicates that said hazardous substance contained in at least one of the homogeneous materials used for this part is above the limit requirement of GB/T 26572.

Note:

This product complies with EU RoHS directives. In this table, "×" indicates that hazardous substances that are exempt from EU RoHS directives are contained.

5.6 Safe Disable Input



Figure 5.16 TUV Mark

The TUV mark identifies that the product complies with the safety standards.

This section gives precautions to support the Safe Disable input. Contact Yaskawa for more information.

The safety function complies with the standards shown in [Table 5.20](#).

Table 5.20 Applied Safety Standards and Unified Standards

Safety Standards	Unified Standards
Functional Safety	IEC/EN 61508:2010 (SIL3)
	IEC/EN 62061:2005/A2:2015 (SILCL3)
	IEC/EN61800-5-2:2016 (SIL3)
Machine Safety	ISO/EN ISO 13849-1:2015 (Cat.3, PL e)
EMC	IEC/EN 61000-6-7:2015

Note:

SIL = Safety Integrity Level.

◆ Safe Disable Specifications

The Safe Disable input provides the stop function that complies with “Safe Torque Off” as specified by IEC/EN 61800-5-2:2007. The Safe Disable input meets the requirements of EN ISO 13849-1 and IEC/EN 61508. It also has a safety status monitor to detect safety circuit errors.

When you install the drive as a component in a system, you must make sure that the system complies with the applicable safety standards.

Refer to [Table 5.21](#) for safety function specifications.

Table 5.21 Safe Disable Specifications

Item	Description
Input/Output	<ul style="list-style-type: none"> Input: 2 Safe Disable input (H1, H2) Signal ON level: 18 Vdc to 28 Vdc Signal OFF level: -4 Vdc to +4 Vdc Output: 1 MFDO safety monitor output for external device monitor (EDM)
Response time from when the input opens to when the drive output stops	3 ms or less
Response time from when the H1 and H2 terminal inputs open to when the EDM signal operates	20 ms or less
Failure probability	Less frequent operation request mode
	Frequent operation request mode or continuous mode
Performance level	The Safe Disable input complies with the performance level requirements of EN ISO 13849-1.
HFT (hardware fault tolerance)	N = 1
Type of subsystem	Type B

Note:

EDM = External Device Monitoring

PFH = Probability of Failure on Demand

PFH = Probability of Dangerous Failure per Hour

◆ Notes

DANGER! *Sudden Movement Hazard. When you use the Safe Disable function in the safety system of a machine, do a full risk assessment for the system to make sure that all parts of the system comply with applicable safety standards. Incorrect application of the Safe Disable function can cause serious injury or death.*

DANGER! *Sudden Movement Hazard. If the output circuit of the drive is damaged and the Safe Disable function turns OFF the drive output to a permanent magnet (PM) motor, the motor can rotate 180 electrical degrees. Prevent damage to equipment and injury to personnel during this condition. Sudden motor movement can cause serious injury or death. It is possible for current to flow through the motor winding in these conditions.*

DANGER! *Electrical Shock Hazard. You cannot depend on the Safe Disable function to prevent electrical shock. Disconnect all power to the drive and wait for the time specified on the warning label before you remove covers. Check the drive for dangerous voltages before servicing or repair work. If you do work on the drive when it is energized and there is no cover over the electronic circuits, it can cause serious injury or death.*

WARNING! *Sudden Movement Hazard. Although the Safe Disable function is in operation, gravity or other external forces in the vertical axis can move the motor. Incorrect application of the Safe Disable function can cause serious injury or death.*

WARNING! *Sudden Movement Hazard. Do not use the drive output signals to control external holding brakes or dynamic brakes for functional safety. Use a system that conforms to the functional safety requirements. Incorrect application of the Safe Disable function can cause serious injury or death. Systems that use drive output signals (including EDM) for safety are not safe because drive output signals are not safety components.*

WARNING! *Sudden Movement Hazard. Connect the Safe Disable inputs to the devices as specified by the safety requirements. If you connect the Safe Disable inputs incorrectly, it can cause serious injury or death.*

WARNING! *Sudden Movement Hazard. To use the Safe Disable inputs, remove the jumpers between terminals H1-HC and H2-HC. If the Safe Disable circuit does not work correctly, it can cause serious injury or death.*

WARNING! *Sudden Movement Hazard. When you clear the Safe Disable input, make sure that the Safe Disable Monitor output operates correctly as the specification for Safe Disable function. If the Safe Disable circuit does not operate correctly, it can cause serious injury or death.*

WARNING! *Sudden Movement Hazard. Regularly examine the Safe Disable input and all other safety features. A system that does not operate correctly can cause serious injury or death.*

WARNING! *Sudden Movement Hazard. Only let approved personnel who know about the drive, instruction manual, and safety standards wire, examine, and maintain the Safe Disable input. If personnel are not approved, it can cause serious injury or death.*

WARNING! *Sudden Movement Hazard. Only use the Safe Disable Monitor (multi-function output terminal set to the EDM function) to monitor the Safe Disable status or to find a malfunction in the Safe Disable inputs. The monitor output is not a safety output. If you use the Safe Disable Monitor incorrectly, it can cause death or serious injury.*

Note:

- Drives that have a built-in safety function must be replaced 10 years after first use.
- A maximum of 3 ms will elapse from when terminals H1 or H2 shut off until the drive switches to the "Safe Torque Off" status. Set the OFF status for terminals H1 and H2 to hold for at least 3 ms. The drive may not be able to switch to the "Safe Torque Off" status if terminals H1 and H2 are only open for less than 2 ms.

◆ Using the Safe Disable Function

■ Safe Disable Circuit

The Safe Disable circuit has two isolated channels (terminals H1 and H2) that stop the output transistors. The input can use the internal power supply of the drive.

Set the EDM function to one of the MFDO terminals [$H2-xx = 21$ or 121] to monitor the status of the Safe Disable function. This is the "Safe Disable monitor output function".

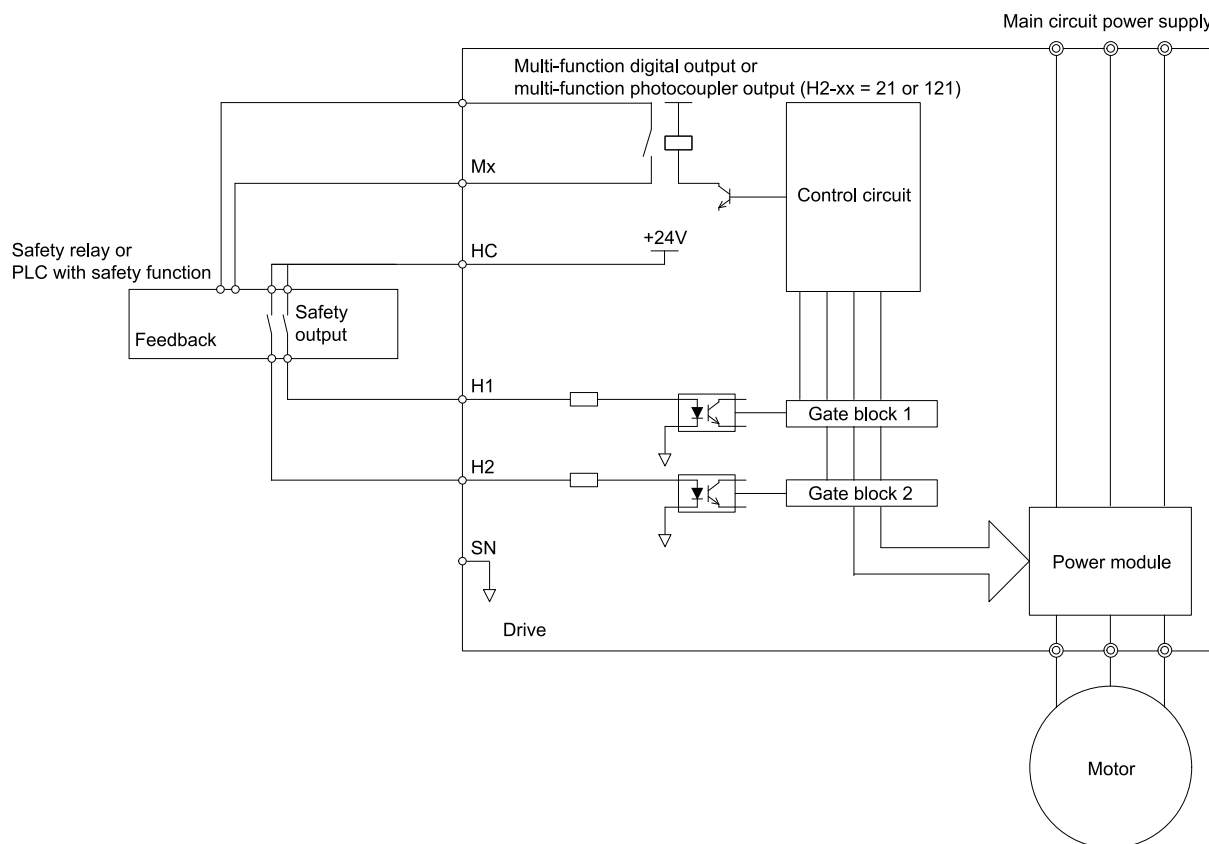

Figure 5.17 Safe Disable Function Wiring Example

■ Connect Safe Disable Input Contacts to Multiple Drives

To Use the Drive Internal Power Supply

An example of connecting Safe Disable contacts is shown in [Figure 5.18](#).

From the terminals HC-SN of drive 1, supply the power for the Safe Disable function for the applicable drives. These conditions limit the number of units to connect:

- Internal power supply capacity
- Number of MFDIs used
- Supply current to the external sensors

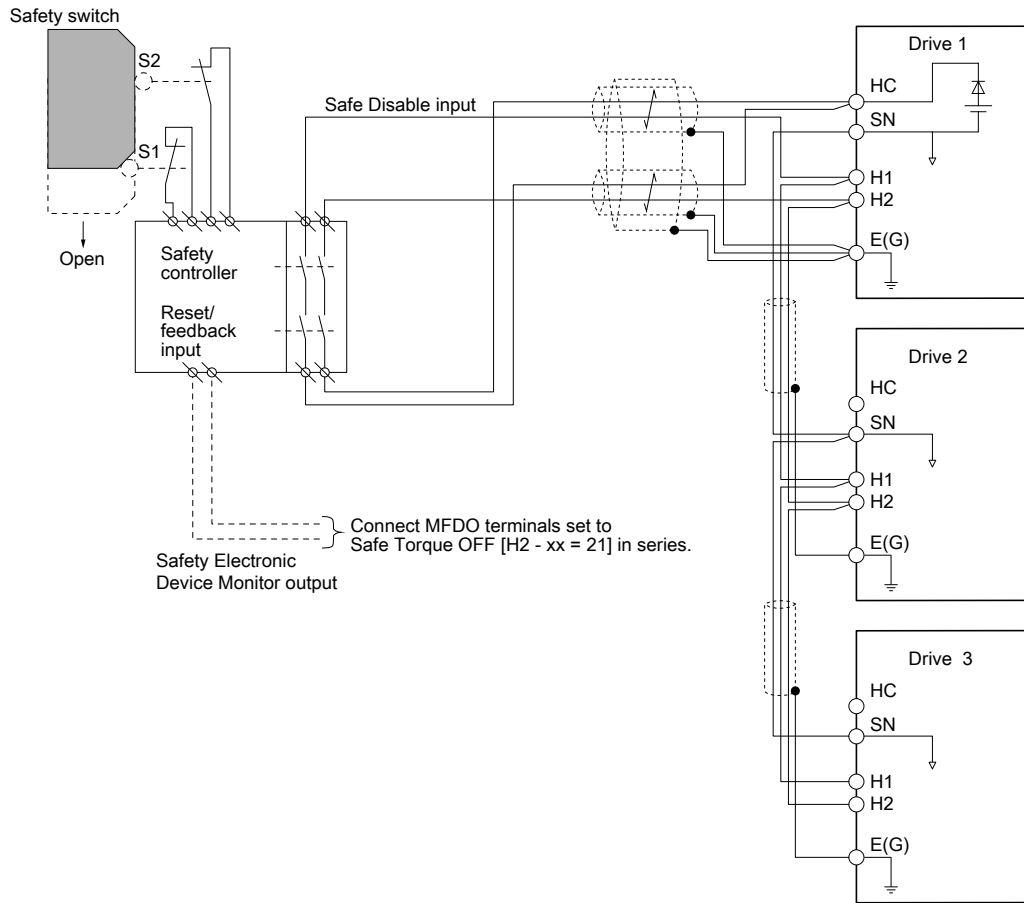

Figure 5.18 Connection Example to Use the Internal Power Supply

To Use 24 V External Power Supply

An example of connecting Safe Disable contacts is shown in Figure 5.19. These conditions limit the number of units to connect:

- External power supply capacity
- Number of MFDIs used
- Supply current to the external sensors

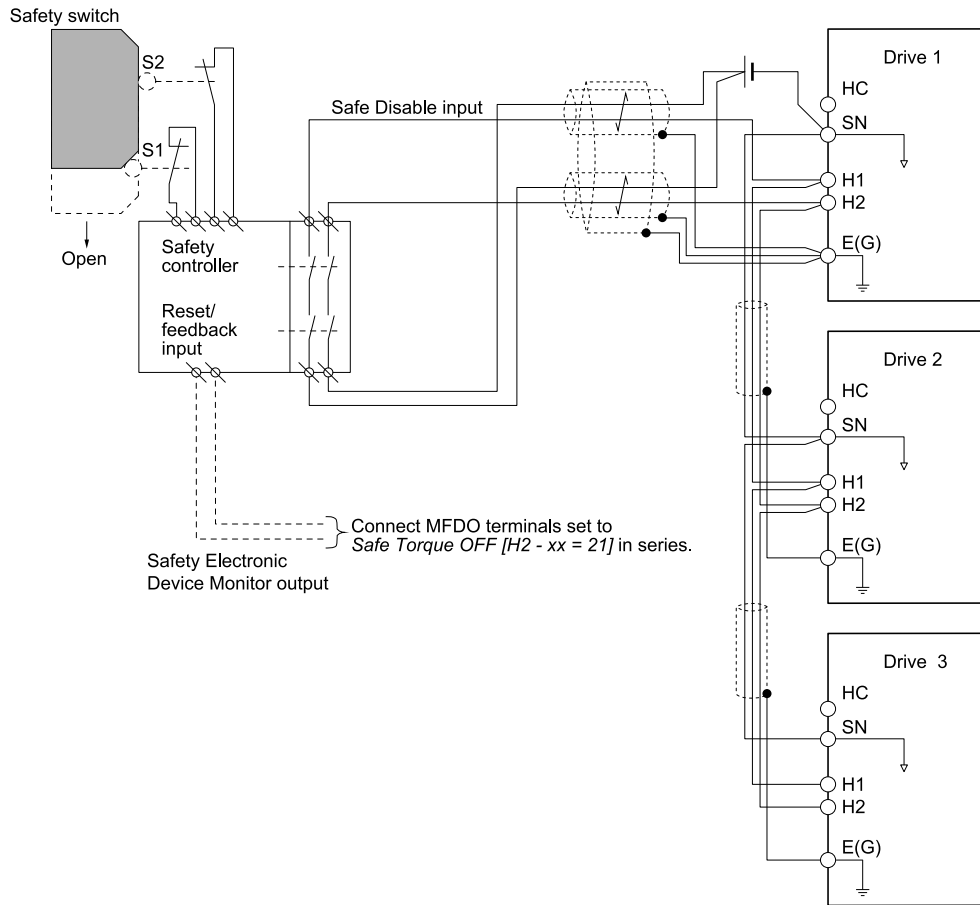

Figure 5.19 Connection Example to Use 24 V External Power Supply

The Number of Possible Units to Connect

Power Supply	MFDI	24 V Output	Number of Drive Units
Internal power supply (Drive 1)	Yes (8-channel input)	Yes *1	3
		No	15
	No	Yes *1	7
		No	19
External power supply	-	-	Different for different external power supply capacities *2

*1 This is when you use a maximum of 150 mA.

*2 24 V, 12 mA is necessary for each drive.

Use the this formula to calculate the number of units to connect:

$$n = (I_{o_{max}} - I_{MFDI} \times n_{MFDI} - I_{sensor}) / I_{safety}$$

- n: Number of units to connect
- $I_{o_{max}}$: Maximum current that can be supplied from the power supply (234 mA for the internal power supply)
- I_{MFDI} : Current consumed per MFDI (6 mA)
- n_{MFDI} : Maximum number of MFDIs that can be activated at the same time (maximum of 8-channel)
- I_{sensor} : Current externally supplied for sensor power supply (maximum of 150 mA)
- I_{safety} : Current consumed by Safe Disable terminals H1 and H2 (12 mA)

Note:

Round the values off to the first decimal place.

■ Enabling and Disabling the Drive Output (“Safe Torque Off”)

Refer to [Figure 5.20](#) for an example of drive operation when the drive changes from “Safe Torque Off” status to usual operation.

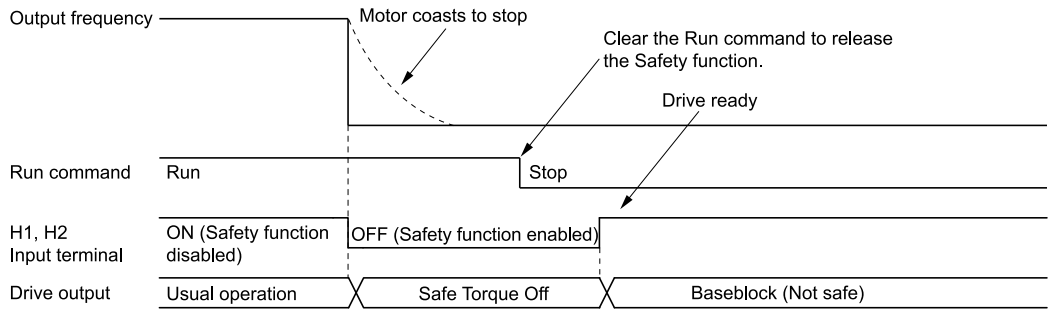

Figure 5.20 Safe Disable Operation

Switching from Usual Operation to “Safe Torque Off”

Turn OFF (open) safety input terminal H1 or H2 to enable the Safe Disable function. When the Safe Disable function is enabled while the motor is operating, the drive output and motor torque turn off and the motor always coasts to stop. The *b1-03 [Stopping Method Selection]* setting does not have an effect on the stopping method.

The “Safe Torque Off” status is only possible with the Safe Disable function. Clear the Run command to stop the drive. Turning off drive output (a baseblock condition) ≠ “Safe Torque Off”.

Note:

- When it is necessary to ramp to stop the motor, do not turn off terminals H1 and H2 until the motor fully stops. This will prevent the motor from coasting to stop during usual operation.
- A maximum of 3 ms will elapse from when terminals H1 or H2 shut off until the drive switches to the “Safe Torque Off” status. Set the OFF status for terminals H1 and H2 to hold for at least 2 ms. The drive may not be able to switch to the “Safe Torque Off” status if terminals H1 and H2 are only open for less than 2 ms.

Going from “Safe Torque Off” to Usual Operation

The safety input will only release when there is no Run command.

- **During Stop**
When the Safe Disable function is triggered during stop, close the circuit between terminals H1-HC and H2-HC to disable “Safe Torque Off”. Enter the Run command after the drive stops correctly.
- **During Run**
When the Safe Disable function is triggered during run, close the circuit between terminals H1-HC and H2-HC to disable “Safe Torque Off” after clearing the Run command. Enter the Stop command, then enter the Run command when terminals H1 and H2 are ON or OFF.

■ Safe Disable Monitor Output Function and Keypad Display

Refer to [Table 5.22](#) for information about the relation between the input channel status, Safety monitor output status, and drive output status.

Table 5.22 Safe Disable Input and External Device Monitor (EDM) Terminal Status

Input Channel Status		Safety Monitor Output Status		Drive Output Status	Keypad Display	LED Status Ring	MEMOBUS Register 0020H	
Input 1 (H1-HC)	Input 2 (H2-HC)	MFDO Terminal (H2-xx = 21)	MFDO Terminal (H2-xx = 121)				bit C	bit D
ON (Close the circuit)	ON (Close the circuit)	OFF	ON	Baseblock (Drive ready)	Normally displayed	Ready: Illuminated	0	0
OFF (Open)	ON (Close the circuit)	OFF	ON	Safety status (STo)	SToF (Flashing)	ALM/ERR: Flashing	1	0
ON (Close the circuit)	OFF (Open)	OFF	ON	Safety status (STo)	SToF (Flashing)	ALM/ERR: Flashing	1	0
OFF (Open)	OFF (Open)	ON	OFF	Safety status (STo)	STo (Flashing)	Ready: Flashing	0	1

Safety Function Status Monitor

The drive Safety monitor output sends a feedback signal about the status of the Safety function. The Safety monitor output is one of the possible settings available for the MFDO terminals. If there is damage to the Safe Disable circuit, a controller (PLC or safety relay) must read this signal as an input signal to hold the “Safe Torque Off” status. This will help verify the condition of the safety circuit. Refer to the manual for the safety device for more information about the Safety function.

It is possible to switch polarity of the Safety monitor output signal with the MFDO function settings. Refer to [Table 5.22](#) for setting instructions.

Keypad Display

If the two input channels are OFF (Open), the keypad will flash *STo* [*Safe Torque OFF*].

If there is damage to the Safe disable circuit or the drive, the keypad will flash *SToF* [*Safe Torque OFF Hardware*] when one input channel is OFF (Open), and the other is ON (Short circuit). When you use the Safe disable circuit correctly, the keypad will not show *SToF*.

If there is damage to the drive, the keypad will show *SCF* [*Safety Circuit Fault*] when the drive detects a fault in the Safe disable circuit. Refer to the chapter on Troubleshooting for more information.

■ Validating the Safe Disable Function

After you replace parts or do maintenance on the drive, first complete all necessary wiring to start the drive, then test the Safe Disable input with these steps. Keep a record of the test results.

1. When the two input channels are OFF (Open), make sure that the keypad flashes *STo* [*Safe Torque OFF*], and make sure that the motor is not running.
2. Monitor the ON/OFF status of the input channels and make sure that MFDO set to the EDM function operates as shown in [Table 5.22](#).

If one or more of these items are true, the ON/OFF status of the MFDO may not display correctly on the keypad:

- Incorrect parameter settings.
- A problem with an external device.
- The external wiring has a short circuit or is disconnected.
- There is damage to the device.

Find the cause and repair the problem to correctly display the status.

3. Make sure that the EDM signal operates during usual operation as shown in [Table 5.22](#).

Network Communications

6.1	Section Safety	270
6.2	Field Bus Network Support.....	271
6.3	MEMOBUS/Modbus Communications	272

6.1 Section Safety

 **DANGER**

Do not ignore the safety messages in this manual.

If you ignore the safety messages in this manual, it will cause serious injury or death. The manufacturer is not responsible for injuries or damage to equipment.

6.2 Field Bus Network Support

You can use the PLC to control and monitor the drive through the network. The drive has a standard RS-485 interface (MEMOBUS/Modbus communications). Install a separately sold communication option on the drive to support other network communications.

◆ Available Communication Options

Refer to [Table 6.1](#) for the field bus networks that are compatible with the drive. Contact Yaskawa or your nearest sales representative to order a communication option.

Table 6.1 Available Field Bus Network

Type of Communications	Option model	Type of Communications	Option model
CC-Link	SI-C3	DeviceNet	SI-N3
MECHATROLINK-II	SI-T3	LonWorks	SI-W3
MECHATROLINK-III	SI-ET3	Modbus TCP/IP	SI-EM3
PROFIBUS-DP	SI-P3	PROFINET	SI-EP3
CANopen	SI-S3	EtherNet/IP	SI-EN3
EtherCAT	SI-ES3	EtherCAT	SI-ES3

6.3 MEMOBUS/Modbus Communications

This section gives detailed information about the parameters, error codes and communication procedures for MEMOBUS/Modbus communications.

◆ Configure Master/Slave

You can use the MEMOBUS/Modbus protocol for serial communication with programmable controllers (PLC).

The MEMOBUS/Modbus communication uses one master (PLC) and a maximum of 31 slave drives. Serial communications usually starts with a signal from the master to the slave drives.

A slave drive that receives a command from the master does the specified function and then sends a response back to the master. You must set the address number for each slave drive before you start signal communications to make sure that the master uses the correct address numbers.

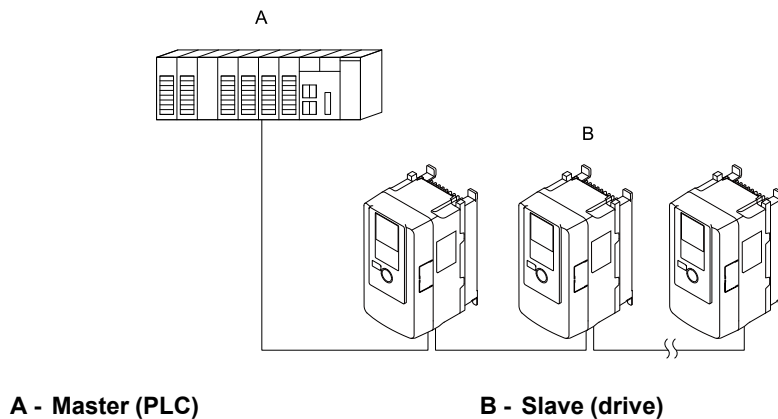

Figure 6.1 PLC and Drive Connection Example

◆ Communication Specifications

Table 6.2 lists the specifications for the MEMOBUS/Modbus communications.

Table 6.2 MEMOBUS/Modbus Specifications

Item	Specification
Interface	RS-485
Synchronization method	Asynchronous (start-stop synchronization)
Communication parameter	Communications speed: 1.2, 2.4, 4.8, 9.6, 19.2, 38.4, 57.6, 76.8, 115.2 kbps
	Data length: 8 bit (fixed)
	Parity: even, odd, none
	Stop bit 1 bit (fixed)
Communication protocol	MEMOBUS/Modbus standard (RTU mode only)
Number of possible units to connect	Maximum: 31 units

◆ Communication with the PLC

This section gives information about the settings for the termination resistor and how to connect to MEMOBUS/Modbus communications. MEMOBUS/Modbus communications uses an RS-485 interface (2-wire sequence).

■ Connect Communications Cable

Use this procedure to start communication between the PLC and drive.

1. De-energize the drive then connect the communications cable to the PLC and the drive. The drive uses terminal TB4 for MEMOBUS/Modbus communications.

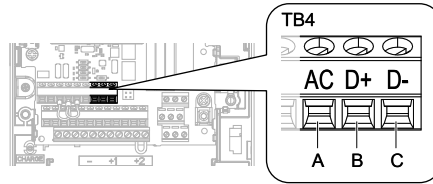

- A - Terminal AC: Signal ground** **C - Terminal D-: Communication input/output (-)**
B - Terminal D+: Communication input/output (+)

Figure 6.2 Communications Cable Connection Terminal (TB4)

Note:

Isolate the communications wiring from the main circuit wiring and other high-power wiring. Use shielded wires for the communications wiring and connect cable sheaths to the ground terminal of the drive. Incorrect wiring procedures could cause drive malfunction because of electrical interference.

2. Install the termination resistor on the network termination slave drive. Set the DIP switch S2 to the ON position to enable the termination resistor on the drive.
3. Energize the drive.
4. Use the drive keypad to set the necessary communications parameters *H5-01* to *H5-12*.
 - *H5-01* [Drive Node Address]
 - *H5-02* [Communication Speed Selection]
 - *H5-03* [Communication Parity Selection]
 - *H5-04* [Stopping Method after Com Error]
 - *H5-05* [Comm Fault Detection Select]
 - *H5-06* [Drive Transmit Wait Time]
 - *H5-09* [CE Detection Time]
 - *H5-10* [Modbus Register 0025H Unit Sel]
 - *H5-11* [Communications ENTER Func Select]
 - *H5-12* [Run Command Method Selection]
5. De-energize the drive and wait for the keypad display to turn off.
6. Energize the drive.

The drive is prepared to start communication with the PLC.

■ Set the Termination Resistor

You must enable the termination resistor on the slave terminal of the drive to use MEMOBUS/Modbus communications. Use DIP switch S2 on the terminal block to enable and disable the built-in termination resistor. Refer to [Figure 6.3](#) for an example of how to set DIP switch S2. Use the tip of a tweezers or a jig with a tip width of 0.8 mm (0.03 in.) to set the DIP switch. When you install the drive in the terminal of the communication line, set DIP switch S2 to ON. Set DIP switch S2 to OFF on all other drives.

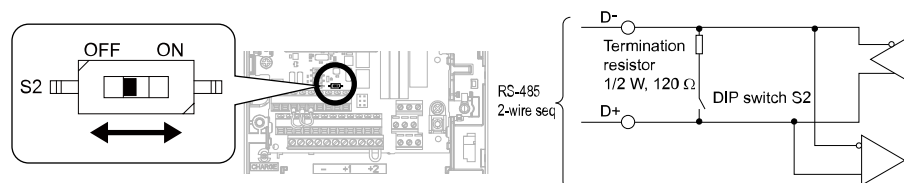

Figure 6.3 MEMOBUS/Modbus Communication Terminal and DIP Switch S2

■ Wiring Diagram for More than One Drive

[Figure 6.4](#) shows how to wire more than one connected drive with using MEMOBUS/Modbus communications.

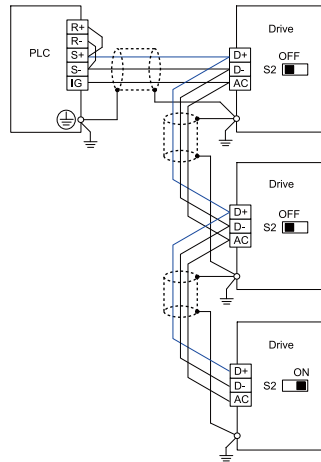

Figure 6.4 Wiring Diagram for More than One Drive

Note:

Set DIP switch S2 to the ON position on the last drive of the MEMOBUS/Modbus communication network to enable the termination resistor.

◆ **MEMOBUS/Modbus Drive Operations**

Drive parameters will apply to the settings when the drive is running during MEMOBUS/Modbus communications. This section gives information about the available functions and their related parameters.

■ **Executable Functions**

A PLC can do these operations with MEMOBUS/Modbus communications. Parameter settings (except H5-xx) do not have an effect on the availability of these operations.

- Monitor the drive status and operate the drive
- Set and view parameters
- Fault Reset Procedure
- Multi-function input setting (The input command from MEMOBUS/Modbus communications and MFDI terminals (S1 to S8) are linked by a logical OR operation.)

■ **Drive Control**

Select the external command that sets the frequency references and motor run/stop with MEMOBUS/Modbus communications. Use the information in Table 6.3 to set the parameters as specified by the application.

Table 6.3 Required Parameter Settings for Drive Control from MEMOBUS/Modbus

LOCAL Control Selected	No.	Name	Setting Value
External reference 1	b1-01	Frequency Reference Selection 1	2 [Memobus/Modbus Communications]
	b1-02	Run Command Selection 1	2 [Memobus/Modbus Communications]
External reference 2	b1-15	Frequency Reference Selection 2	2 [Memobus/Modbus Communications]
	b1-16	Run Command Selection 2	2 [Memobus/Modbus Communications]

For more information about operation mode selection, refer to [Frequency Reference Selection 1] and b1-02 [Run Command Selection 1]. Refer to H1-xx = 2 [MFDI Function Select = External Reference 1/2 Selection] for more information about external command.

◆ **Communications Timing**

To prevent overrun of the slave side, the master cannot send a message to the same drive for a selected length of time. To prevent overrun of the master side, the slave cannot send a response message to the master for a selected length of time.

This section gives information about message timing.

■ Command Message from Master to Slave

To prevent data loss and overrun, after the master receives a message from the slave, the master cannot send the same type of command message to the same slave for a selected length of time. The minimum wait time is different for each type of message. Refer to [Table 6.4](#) to find the minimum wait times.

Table 6.4 Minimum Wait Time to Send a Message

Command Type	Example	Minimum Wait Time
1	<ul style="list-style-type: none"> Operation commands (Run command, stop command) I/O settings Reading the motor and parameter setting values 	5 ms ^{*1}
2	Writing a parameter	50 ms ^{*1}
3	Writing of modified data with the Enter command	3 to 5 s ^{*1}

*1 When the drive receives a message in the minimum wait time, it does command type 1 and sends a response message. If the drive receives command type 2 or command type 3 messages in the minimum wait time, it will trigger a communications error or the drive will ignore the command.

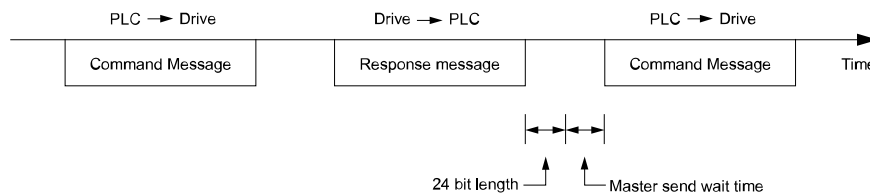

Figure 6.5 Minimum Wait Time to Send a Message

You must set the timer in the master to measure the length of time for the slave to respond to the master. If you set the timer, but the slave does not send a response message in a specified length of time, the master will send the message again.

■ Response Message from Slave

The slave receives the command message from the master then processes the data it received. The slave then waits for the time set in *H5-06 [Drive Transmit Wait Time]* then sends a response message to the master. If overrun occurs on the master, increase the wait time set in *H5-06*.

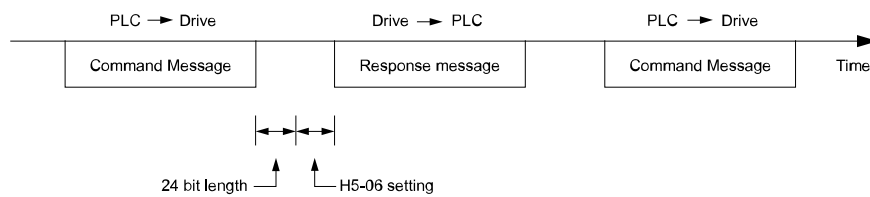

Figure 6.6 Response Wait Time

◆ Message Format

■ Communication Message Description

In MEMOBUS/Modbus communications, the master sends commands to the slave, then the slave responds. The master and slave send their messages in the configuration in [Figure 6.7](#). The length of the data changes when the description of the command (function) changes.

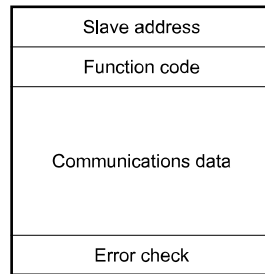

Figure 6.7 Message Format

■ Slave Address

Set the slave address of the drive to 00 to FF (Hex.). When the slave address is 00 (Hex), the master sends the command and all slaves receive the command.

The slave will not send a response message to the master.

■ Function Code

There are five function codes that set commands. [Table 6.5](#) shows the different codes.

Table 6.5 Function Codes

Function Code (Hex.)	Subfunction Code (Hex.)	Function	Command Message		Response Message	
			Minimum Data Length (byte)	Maximum Data Length (byte)	Minimum Data Length (byte)	Maximum Data Length (byte)
03	-	Read the Description of Holding Register	8	8	7	37
08	-	Loopback Test	8	8	8	8
10	-	Writing to Multiple Holding Registers	11	41	8	8
5A	-	Writing to Multiple Holding Registers / Reading the Register Indicated	11	41	17	17
67	010D	Reading Contents of Non-Consecutive Holding Registers	10	248	10	248
	010E	Writing to Non-Consecutive Holding Registers	14	250	8	8

■ Communications Data

Communications data is a series of data that uses the combination of the communications register number and the data for these registers. The data length changes when the description of the command changes. For a loopback test, it switches to test code.

The communications register for the drive has a 2-byte length. Data that is written to the register for the drive is usually 2 bytes. Register data that is read from the drive is also 2 bytes.

■ Error Check

Error check uses the CRC-16 method to detect transmission errors. Use the procedure in this section to calculate CRC-16.

Command Data

When the drive receives data, it will make sure that there are no errors in the data. The drive uses the procedure below to calculate CRC-16, then compares that data with the CRC-16 value in the message. If the CRC-16 values do not agree, the drive will not execute a command message.

When you calculate CRC-16 in MEMOBUS/Modbus communications, make sure that you set the start value as FFFF (Hex.). All 16 bits must be 1.

Use this procedure to calculate CRC-16:

1. Make sure that the start value is FFFF (Hex.).
2. Calculate the FFFF (Hex.) start value and the XOR of the slave address (exclusive OR).
3. Move the step 2 results one column to the right. Do this shift until the carry bit is 1.
4. When the carry bit is 1, calculate XOR via the result from the above step 3 and A001 (Hex.).
5. Do steps 3 and 4 until the 8th shift to the right.
6. Use the result of step 5 to calculate the XOR and the data of the following messages (function code, register address, data). Do steps 3 to 5 until the last data, then calculate.
7. The result of the last right shift or the value of the last XOR calculation is the result for CRC-16.

Figure 6.8 lists examples of the CRC-16 calculation of slave address 02 (Hex.) and function code 03 (Hex.). The calculated results of CRC-16 for this section is D140 (Hex.).

Note:

The calculation example only gives information about some error checks with CRC-16. The drive will do the same error checks for the next data.

Description	Calculation	Overflow	Description	Calculation	Overflow
Initial value (FFFF(Hex.))	1111 1111 1111 1111		Function code 03 (Hex.)	0000 0011	
Address 02 (Hex.)	0000 0010		XOR w result	1000 0001 0011 1101	
XOR w initial value	1111 1111 1111 1101		Shift 1	0100 0000 1001 1110	1
Shift 1	0111 1111 1111 1110	1	XOR w A001 (Hex.)	1010 0000 0000 0001	
XOR w A001 (Hex.)	1010 0000 0000 0001		XOR result	1110 0000 1001 1111	
XOR result	1101 1111 1111 1111		Shift 2	0111 0000 0100 1111	1
Shift 2	0110 1111 1111 1111	1	XOR w A001 (Hex.)	1010 0000 0000 0001	
XOR w A001 (Hex.)	1010 0000 0000 0001		XOR result	1101 0000 0100 1110	
XOR result	1100 1111 1111 1110		Shift 3	0110 1000 0010 0111	0
Shift 3	0110 0111 1111 1111	0	Shift 4	0011 0100 0001 0011	1
Shift 4	0011 0011 1111 1111	1	XOR w A001 (Hex.)	1010 0000 0000 0001	
XOR w A001 (Hex.)	1010 0000 0000 0001		XOR result	1001 0100 0001 0010	
XOR result	1001 0011 1111 1110		Shift 5	0100 1010 0000 1001	0
Shift 5	0100 1001 1111 1111	0	Shift 6	0010 0101 0000 0100	1
Shift 6	0010 0100 1111 1111	1	XOR w A001 (Hex.)	1010 0000 0000 0001	
XOR w A001 (Hex.)	1010 0000 0000 0001		XOR result	1000 0101 0000 0101	
XOR result	1000 0100 1111 1110		Shift 7	0100 0010 1000 0010	1
Shift 7	0100 0010 0111 1111	0	XOR w A001 (Hex.)	1010 0000 0000 0001	
Shift 8	0010 0001 0011 1111	1	XOR result	1110 0010 1000 0011	
XOR w A001 (Hex.)	1010 0000 0000 0001		Shift 8	0111 0001 0100 0001	1
XOR result	1000 0001 0011 1110		XOR w A001 (Hex.)	1010 0000 0000 0001	
			XOR result	1101 0001 0100 0000	
				1101 0001 0100 0000	
			CRC-16	D 1 4 0	
				(Lower) (Upper)	
Perform operations with next data (function code)			Continue from here with next data.		

Figure 6.8 CRC-16 Calculation Example

Response Data

The drive does the CRC-16 calculation for the response message and makes sure that the data does not have errors. Make sure that the calculated value is the same value as the CRC-16 in the response message.

◆ Examples of Messages for Commands/Responses

The items in this section are examples of messages for commands/responses.

■ Read the Description of Holding Register

Uses function code 03 (Hex.) to read the contents of a maximum of 16 holding registers.

Figure 6.9 shows example messages when the drive reads status signal from the drive of slave 2, the error contents, fault contents, and frequency references.

Byte	Command Message		Response Message (normal)			Response Message (fault)		
		Setting Data (Hex.)		Setting Data (Hex.)		Setting Data (Hex.)		Setting Data (Hex.)
0	Slave address		Slave address		Slave address		Slave address	
1	Function code		Function code		Function code		Function code	
2	Starting No.	Upper	00	Data Qty		Error code		03
3		Lower	20	First storage register	Upper	00	CRC-16	Upper
4	Data Qty	Upper	00		Lower	65		Lower
5		Lower	04	Next storage register	Upper	00	-	
6	CRC-16	Upper	45		Lower	00	-	
7		Lower	F0	Next storage register	Upper	00	-	
8	-		Lower		00	-		
9	-		Next storage register	Upper	01	-		
10	-			Lower	F4	-		
11	-		CRC-16	Upper	AF	-		
12	-			Lower	82	-		

Figure 6.9 Message Example When Reading the Contents of Holding Register

■ Loopback Test

The loopback test uses function code 08 (Hex.) and returns the command message as a response message. This test checks communication between the master and slave. The test code and data can use desired values.

Figure 6.10 shows examples of messages given out when the loopback test is done with the drive of slave 1.

Byte	Command Message		Response Message (normal)			
		Setting Data (Hex.)		Setting Data (Hex.)		
0	Slave address		Slave address		01	
1	Function code		Function code		08	
2	Test code	Upper	00	Test code	Upper	00
3		Lower	00		Lower	00
4	Data	Upper	A5	Data	Upper	A5
5		Lower	37		Lower	37
6	CRC-16	Upper	DA	CRC-16	Upper	DA
7		Lower	8D		Lower	8D

Figure 6.10 Message Example When Doing the Loopback Test

■ Writing to Multiple Holding Registers

You can write the data that you set to the number of holding registers set in function code 10 (hex). You must configure the number of the holding registers and each 8 higher bits and 8 lower bits in order in the command message for the write data. You can write to a maximum of 16 holding registers.

Figure 6.11 shows example messages when you use the PLC to set Forward run in the drive of slave 1 with a 60.00 Hz frequency reference.

When you rewrite the parameter value with the write command through the *H5-11 [Comm ENTER Command Mode]* setting, you must use the Enter command to save and enable the contents of the changes. Refer to *H5-11: Comm ENTER Command Mode on page 889* and *Enter Command on page 282* for more information.

Byte	Command message		Response message (when normal)		Response message (when there is a fault)	
		Setting data (Hex.)		Setting data (Hex.)		Setting data (Hex.)
0	Slave address		Slave address		Slave address	
1	Function code		Function code		Function code	
2	Starting No.	Upper	00	Starting No.	Upper	00
3		Lower	01		Lower	01
4	Data Qty	Upper	00	Data Qty	Upper	00
5		Lower	02		Lower	02
6	Byte No.		04	CRC-16	Upper	10
7	First data	Upper	00		Lower	08
8		Lower	01			-
9	Next data	Upper	17			-
10		Lower	70			-
11	CRC-16	Upper	6D			-
12		Lower	B7			-

Figure 6.11 Message Example When Writing to Multiple Holding Registers

Note:

The number of bytes set in the command message set the data quantity $\times 2$ during the command message. The response message uses the same formula.

■ Reading from More than One Holding Register/Reading the Indicated Register

The drive uses function code 5A (Hex.) to write to more than one register, then it reads the contents of four holding registers at the same time.

The function for writing to more than one register is the same as the function for function code 10 (Hex.). You can write to a maximum of 16 holding registers.

The four holding registers to be read from are specified in *H5-25 to H5-28 [Function 5A Register x Selection]*.

Table 6.6 shows example messages when you write to more than one holding register or when you read more than one command register. Table 6.6 uses this register data for the examples:

- The drive for slave 1 is set for Forward run with a frequency reference of 60.00 Hz.
- The setting in *H5-25 to H5-28* and the data in the specified holding registers are as follows.
 - *H5-25* = 0044H: *U1-05 [Motor Speed]* = 60.00 Hz (6000 = 1770H)
 - *H5-26* = 0045H: *U1-06 [Output Voltage Ref]* = 200.0 V (2000 = 07D0H)
 - *H5-27* = 0042H: *U1-03 [Output Current]* = 50% of drive rated current (100% = 8192, 50% = 4096 = 1000H)
 - *H5-28* = 0049H: *U1-10 [Input Terminal Status]* = 00H

When you rewrite the parameter value with the write command through the *H5-11 [Comm ENTER Command Mode]* setting, you must use the Enter command to save and enable the contents of the changes. Refer to *H5-11: Comm ENTER Command Mode on page 889* and *Enter Command on page 282* for more information.

Table 6.6 Message Example When Reading from More than One Holding Register/Reading the Indicated Register

Byte	Command Message		Response Message (when normal)		Response Message (when there is a fault)	
		Setting Data (Hex.)		Setting Data (Hex.)		Setting Data (Hex.)
0	Slave address		Slave address		Slave address	
1	Function Code		Function Code		Function Code	

6.3 MEMOBUS/Modbus Communications

Byte	Command Message			Response Message (when normal)			Response Message (when there is a fault)		
			Setting Data (Hex.)			Setting Data (Hex.)			Setting Data (Hex.)
2	Starting No.	Upper	00	Register status			Register status		
3		Lower	01	Data in holding register 1 selected with H5-25	Upper	17	Data in holding register 1 selected with H5-25	Upper	17
4	Data Qty	Upper	00		Data in holding register 2 selected with H5-26	Lower		70	Data in holding register 2 selected with H5-26
5		Lower	02	Data in holding register 3 selected with H5-27		Upper	07	Data in holding register 3 selected with H5-27	
6	Byte No.		04		Data in holding register 4 selected with H5-28	Lower	D0		Data in holding register 4 selected with H5-28
7	First data	Upper	00	Starting No.		Upper	10	Error Codes	
8		Lower	01		Data Qty	Lower	00		CRC-16
9	Next data	Upper	17	CRC-16		Upper	00	Upper	
10		Lower	70		CRC-16	Lower	00		Lower
11	CRC-16	Upper	4F	CRC-16		Upper	00	Upper	
12		Lower	43		CRC-16	Lower	01		Lower
13	-	-	CRC-16	Upper		00	CRC-16	Upper	
14	-	-		Lower	02	-			
15	-	-	Upper	AC	-				
16	-	-	Lower	D0	-				

Note:

The number of bytes set in the command message set the data quantity $\times 2$ during the command message.

Register status	
bit 0	Data in register 1 selected with H5-25 1: Successfully read the register 0: Register read error
bit 1	Data in register 2 selected with H5-26 1: Successfully read the register 0: Register read error
bit 2	Data in register 3 selected with H5-27 1: Successfully read the register 0: Register read error
bit 3	Data in register 4 selected with H5-28 1: Successfully read the register 0: Register read error
bit 4	Not used
bit 5	Not used
bit 6	Not used
bit 7	Not used

■ Reading the Contents of Non-Consecutive Holding Registers

The drive uses function code 67 (Hex.) and subfunction code 010D (Hex.) to read data with a maximum of 120 holding registers.

You must give the holding register number from which to read separately.

Table 6.7 shows example messages when you read the frequency reference and torque limit from the drive for slave 1. Table 6.7 uses these specified holding registers data for the examples.

- 0024H:U1-01 [Frequency Reference] = 60.00 Hz (6000 = 1770H)
- 0028H:U1-09 [Torque Reference] = 100.0% (1000 = 03E8H)

Table 6.7 Message Example When Reading the Contents of Non-Consecutive Holding Registers

Byte	Command Message			Response Message (when normal)			Response Message (when there is a fault)		
			Setting Data (Hex.)			Setting Data (Hex.)			Setting Data (Hex.)
0	Slave address		01	Slave address		01	Slave address		01
1	Function Code		67	Function Code		67	Function Code		E7
2	Subfunction Code	Upper	01	Subfunction Code	Upper	01	Error Codes		02
3		Lower	0D		Lower	0D	CRC-16	Upper	EA
4	Data Qty	Upper	00	Byte No.	Upper	00		Lower	31
5		Lower	02		Lower	04	-		
6	Holding register 1 No.	Upper	00	Holding register 1 data	Upper	17	-		
7		Lower	24		Lower	70	-		
8	Holding register 2 No.	Upper	00	Holding register 2 data	Upper	03	-		
9		Lower	28		Lower	E8	-		
10	CRC-16	Upper	8B	CRC-16	Upper	47	-		
11		Lower	29		Lower	ED	-		

Note:

The number of bytes set within the response message sets twice the number of data contained in the command message.

■ Writing to Non-Consecutive Holding Registers

The drive uses function code 67 (Hex.) and subfunction code 010E (Hex.) to read data with a maximum of 60 holding registers.

You must give the holding register number from which to write separately.

Table 6.8 shows example messages when you write the frequency reference and torque limit from the drive for slave 1. Table 6.8 uses these specified holding registers data for the examples.

- 0002H: Frequency Reference = 60.00 Hz (6000 = 1770H)
- 0004H: Torque Limit = 150.0% (1500 = 05DCH)

When you rewrite the parameter value with the write command through the *H5-11 [Comm ENTER Command Mode]* setting, you must use the Enter command to save and enable the contents of the changes. Refer to *H5-11: Comm ENTER Command Mode on page 889* and *Enter Command on page 282* for more information.

Table 6.8 Message Example When Writing to Non-Consecutive Holding Registers

Byte	Command Message			Response Message (when normal)			Response Message (when there is a fault)		
			Setting Data (Hex.)			Setting Data (Hex.)			Setting Data (Hex.)
0	Slave address		01	Slave address		01	Slave address		01
1	Function Code		67	Function Code		67	Function Code		E7
2	Subfunction Code	Upper	01	Subfunction Code	Upper	01	Error Codes		02
3		Lower	0E		Lower	0E	CRC-16	Upper	EA
4	Data Qty	Upper	00	Data Qty	Upper	00		Lower	31
5		Lower	02		Lower	02	-		
6	Byte No.	Upper	00	CRC-16	Upper	D5	-		
7		Lower	04		Lower	FC	-		
8	Holding register 1 No.	Upper	00	-		-			
9		Lower	02	-		-			

Byte	Command Message			Response Message (when normal)		Response Message (when there is a fault)	
			Setting Data (Hex.)		Setting Data (Hex.)		Setting Data (Hex.)
10	Holding register 1 data	Upper	17	-	-	-	-
11		Lower	70	-	-	-	-
12	Holding register 2 No.	Upper	00	-	-	-	-
13		Lower	04	-	-	-	-
14	Holding register 2 data	Upper	05	-	-	-	-
15		Lower	DC	-	-	-	-
16	CRC-16	Upper	55	-	-	-	-
17		Lower	59	-	-	-	-

Note:

The number of bytes set in the command message set the data quantity $\times 2$ during the command message.

◆ Enter Command

When you use MEMOBUS/Modbus communications to write parameters from the PLC to the drive, the *H5-11 [Comm ENTER Command Mode]* setting sets the function to enable these parameters from the Enter command. This section gives information about the Enter command.

■ Types of Enter Commands

The drive supports the two Enter commands shown in [Table 6.9](#).

Write 0 to register number 0900 or 0910 (Hex.) to enable the Enter command. You can only write to these registers. If you read to these registers, it will cause an error.

Table 6.9 Types of Enter Commands

Register No. (Hex.)	Description
0900	When you write parameter data to the EEPROM, you will enable the data on the RAM at the same time. This process saves the parameter changes until you de-energize the drive.
0910	This updates the data on the RAM, but does not write data to the EEPROM. This process saves the parameter changes until you de-energize the drive.

Note:

- You can write the EEPROM to the drive a maximum of 100,000 times. Do not frequently execute the Enter command (0900 (Hex.)) that is written to EEPROM. The Enter command register is write-only. If this register is read, it will cause a Register Number Error (02 (Hex.)).
- When the command data or broadcast message is transmitted to the drive, the Enter command is not necessary.

■ Functions of the Enter Command when Replacing a Previous Generation Drive

When you replace a previous generation Yaskawa drive with this product, you must set the Enter command function for this product the same as the previous product. The Enter command function is different for Yaskawa G7, F7-series, and V7-series drives.

Use *H5-11* to set the Enter command function:

- When replacing G7 and F7 series drives, set *H5-11 = 0 [ENTER Command Required]*.
- When replacing V7 series drives, set *H5-11 = 1 [ENTER Command Not Required]*.
- When replacing 1000-series drives, set *H5-11* to the same value as the drive you replaced.

Table 6.10 Enter Command Function Differences

H5-11 Settings	H5-11 = 0	H5-11 = 1
The drive you replaced	G7, F7	V7
Time when the parameter settings are enabled	When the drive receives the Enter command from the master	When you change the parameter settings

H5-11 Settings	H5-11 = 0	H5-11 = 1
Upper and lower limit check	Checks the upper and lower limits and considers the related parameter settings.	Checks the upper and lower limit of the changed parameter only.
Default setting of related parameters	Will not change related parameter settings. You must change the parameters manually.	Automatically changes the default settings for the related parameters.
Fault detection when setting more than one parameter	Accepts and responds as usual to correct setting data if the data contains parameter setting errors. The drive discards the disabled setting data, but will not return an error message.	If there is a setting error in a parameter, the drive responds with a fault. The drive discards the data that was sent.

◆ Self-Diagnostics

The drive can use Self-Diagnostics to find the operation of the serial communications interface circuit. Self-Diagnostics connects the transmission terminal to the reception terminal on the control circuit. It then transmits the data sent by the drive and makes sure that the drive can communicate correctly.

Use this procedure to do Self-Diagnostics:

1. Energize the drive.
2. Set $H1-06 = 67$ [*Terminal S6 Function Selection = Communications Test Mode*].
3. De-energize the drive.
4. Connect a jumper between control circuit terminals S6 and SN.

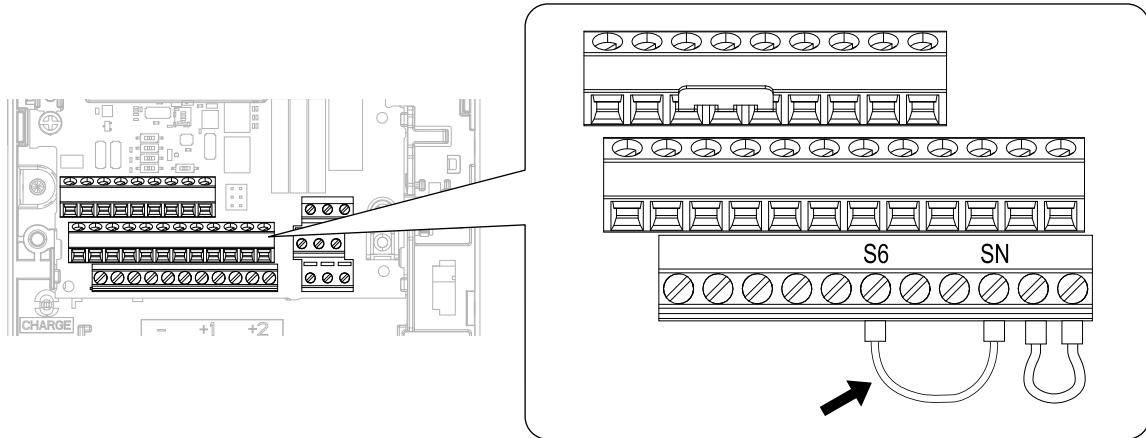

Figure 6.12 Self-Diagnostics Jumper Terminals

5. Energize the drive.
6. When normal, the keypad will show *PASS* [*MEMOBUS/Modbus Communications Test Mode Normal*]. When there is an error, the keypad will show *CE* [*MEMOBUS/Modbus Communications Error*].
7. De-energize the drive.
8. Disconnect the wire jumper between terminals S6 and SN. Set terminal S6 to its initial function.

Self-Diagnostics is complete and the drive returns to its usual function.

◆ Communications Data Table

[Command Data on page 283](#), [Monitor Data on page 287](#) and [Broadcast Messages on page 302](#) show the communications data. The data types are command data, monitor data, and broadcast message.

Refer to the Parameter List for parameter communications registers.

■ Command Data

You can read and write command data.

Note:

Set the reserved bit to 0. Do not write the data in the reserved register or the monitor register.

Table 6.11 MEMOBUS/Modbus Communications Command Data

Register No. (Hex.)	Description	
0000	Reserved	
0001	Run command, multi-function input command	
	bit 0	When $H5-12 = 0$, Forward run/stop 1: Forward run, 0: Stop When $H5-12 = 1$, run/stop 1: Run, 0: Stop
	bit 1	When $H5-12 = 0$, Reverse run/stop 1: Reverse run, 0: Stop When $H5-12 = 1$, Forward/Reverse run 1: Reverse, 0: Forward run
	bit 2	External fault 1: EF0 [Option Card External Fault]
	bit 3	Fault Reset 1: Reset command
	bit 4	Multi-function input 1 When $H1-01 = 40$ [Forward Run Command (2-Wire Seq)], the multi-function input command is "ComRef." Note: When you switch the bit ON as ComRef, the frequency reference source changes to MEMOBUS/Modbus communications. When you connect a communication option to the drive, the frequency reference source gives priority to the communications option.
	bit 5	Multi-function input 2 When the multi-function input command is $H1-02 = 41$ [Reverse Run Command (2-Wire Seq)], bit 5 is "ComCtrl." Note: When you switch the bit ON as ComCtrl, the Run Command source changes to MEMOBUS/Modbus communications. When you connect a communication option to the drive, the Run Command source gives priority to the communications option.
	bit 6	Multi-function input 3
	bit 7	Multi-function input 4
	bit 8	Multi-function input 5
	bit 9	Multi-function input 6
	bit A	Multi-function input 7
	bit B	Multi-function input 8
	bit C - F	Reserved
0002	Frequency Reference	$01-03$ [Frequency Display Unit Selection] (unsigned) sets the units.
0003	Output voltage gain	Units: 0.1 % Setting range: 20 (2.0%) to 2000 (200.0%), the default value at energize: 1000 (100.0%)
0004	Torque reference/torque limit (0.1% signed)	
0005	Torque compensation (0.1% signed)	
0006	PID setpoint (0.01% signed)	
0007	Setting for the multi-function analog monitor output terminal 1 (10 V/4000 H)	
0008	Setting for the multi-function analog monitor output terminal 2 (10 V/4000 H)	

Register No. (Hex.)	Description	
0009	MFDO setting	
	bit 0	MFDO (terminal M1-M2) 1: ON, 0: OFF
	bit 1	MFDO (terminal M3-M4) 1: ON, 0: OFF
	bit 2	MFDO (terminal M5-M6) 1: ON, 0: OFF
	bit 3 - 5	Reserved
	bit 6	1: bit 7 function is enabled
	bit 7	Fault relay output (terminal MA/MB-MC) 1: ON, 0: OFF
	bit 8 - F	Reserved
000A	Pulse train output (Units: 1/1 Hz, setting range: 0 to 32000)	
000B - 000E	Reserved	
000F	Command selection setting	
	bit 0	Reserved
	bit 1	Input for the PID setpoint 1: Enables target values from MEMOBUS/Modbus
	bit 2	Torque reference/torque limit input 1: Enables setting values from MEMOBUS/Modbus
	bit 3	Torque Compensation Input 1: Enables setting values from MEMOBUS/Modbus
	bit 4	Reserved
	bit 5	PID feedback from the MEMOBUS/Modbus 1: Enables PID feedback (15FF (Hex.)) from MEMOBUS/Modbus
	bit 6 - B	Reserved
	bit C	Terminal S5 input of broadcast message 1: Enabled, 0: Disabled
	bit D	Terminal S6 input of broadcast message 1: Enabled, 0: Disabled
	bit E	Terminal S7 input of broadcast message 1: Enabled, 0: Disabled
	bit F	Terminal S8 input of broadcast message 1: Enabled, 0: Disabled
0010 - 001A	Reserved	
001B	Analog monitor option AO-A3 analog output 1 value (10 V/4000 (Hex.))	
001C	Analog monitor option AO-A3 analog output 2 value (10 V/4000 (Hex.))	
001D	Digital output option DO-A3 output value (binary)	
001E - 001F	Reserved	
15C0	bit 0	Extended multi-function input command 1
	bit 1	Extended multi-function input command 2
	bit 2	Extended multi-function input command 3
	bit 3 - F	Reserved

6.3 MEMOBUS/Modbus Communications

Register No. (Hex.)	Description	
15DF	bit 0	Speed Search from Fmax 1: Enables Speed Search from Fmax • This is the same function as H1-xx = 61 [MFDI Function Selection = Speed Search from Fmax]. It operates as specified by the command and OR operation from the MFDI terminals.
	bit 1	Baseblock command 1: Enables baseblock command • This is the same function as H1-xx = 8 [Baseblock Command (N.O.)]. It operates as specified by the command and OR operation from the MFDI terminals.
	bit 2	Baseblock command - Without message 1: Enables baseblock command • This is the same function as H1-xx = 8 [Baseblock Command (N.O.)]. • The keypad does not show the bb [Baseblock] alarm message. The ALM LED does not flash.
	bit 3	Coast-to-stop command 1: Enables coast-to-stop command • The drive shuts off the output and the motor coasts to stop at the leading edge of bit 3. • To restart the drive, set bit 3 to 0 and enter the Run command again.
	bit 4	Ramp to stop command 1: Enables ramp to stop command • The drive ramps to stop in the selected deceleration time at the leading edge of bit 4. • To restart the drive, set bit 4 to 0 and enter the Run command again.
	bit 5	Fast stop command 1: Enables fast stop command • This is the same function as H1-xx = 15 [Fast Stop (N.O.)]. It operates as specified by the command and OR operation from the MFDI terminals.
	bit 6	Soft start input reset 1: Enables soft start input reset • When bit 6 is 1, the input to the soft starter will be 0. The drive decelerates the motor in the selected deceleration time. When bit 6 is 0, the motor accelerates to the previous frequency reference. • U1-01 [Frequency Reference] shows the set frequency reference.
	bit 7	Soft start output reset 1: Enables soft start output reset • When bit 7 is 1, the output from the soft starter will be 0. • When A1-02 = 3, 7 [Control Method Selection = Closed Loop Vector or PM Closed Loop Vector], the drive decelerates the motor as specified by the torque limit. When A1-02 ≠ 3, 7, the drive shuts off the output and the motor coasts. • When bit 6 is 0, the motor accelerates to the previous frequency reference.
	bit 8	Accel/decel ramp hold command 1: Enables accel/decel ramp hold command • This is the same function as H1-xx = A [Accel/Decel Ramp Hold]. It operates as specified by the command and OR operation from the MFDI terminals.
	bit 9	JOG command 1: Enables JOG command • This is the same function as H1-xx = 6 [Jog Reference Selection]. It operates as specified by the command and OR operation from the MFDI terminals.
	bit A	Forward Jog 1: Enables FJOG command • This is the same function as H1-xx = 12 [Forward Jog]. It operates as specified by the command and OR operation from the MFDI terminals.
	bit B	Reverse Jog 1: Enables RJOG command • This is the same function as H1-xx = 13 [Reverse Jog]. It operates as specified by the command and OR operation from the MFDI terminals.
bit C	PID Disable command 1: Enables PID Disable command • This the same function as H1-xx = 19 [PID Disable]. It operates as specified by the command and OR operation from the MFDI terminals.	
bit D - F	Reserved	
3004	Time Setting Setting range: 0000 to 2359 (decimal), the default value at energize: 0000 Set the hour and the minute in HHMM format. • HH: 00 to 23 (decimal) • MM: 00 to 59 (decimal)	

Register No. (Hex.)	Description
3005	Year and Day Setting Setting range: 1600 to 9906 (decimal), the default value at energize: 1600 Set the year and the day of the week in YYDW format. <ul style="list-style-type: none"> • YY: the last two digits of the year from 16 to 99 (decimal) • DW: the day of the week <ul style="list-style-type: none"> – Sunday: 00 – Monday: 01 – Tuesday: 02 – Wednesday: 03 – Thursday: 04 – Friday: 05 – Saturday: 06
3006	Date Setting Setting range: 101 to 1231 (decimal), the default value at energize: 101 Set the month and the date in MMDD format. <ul style="list-style-type: none"> • MM: 01 to 12 (decimal) • DD: 01 to 31 (decimal)
3007	Set the Date Information Setting range: 0 to 8 (decimal), the default value at energize: 8 Set the values specified in 3004H to 3006H as the date and time. <ul style="list-style-type: none"> • Command Data: 1 • Response Data: 0 (normal), 8 (fault)

■ Monitor Data

You can only read monitor data.

Table 6.12 Monitor Data for MEMOBUS/Modbus Communication

Register No. (Hex.)	Description	
0020	Drive Status 1	
	bit 0	During Run 1: During run, 0: During stop
	bit 1	During reverse 1: During reverse, 0: Forward run
	bit 2	Drive ready 1: Ready, 0: Not ready
	bit 3	Faults 1: Fault
	bit 4	Data Setting Error 1: oPExx error
	bit 5	MFDO (terminal M1-M2) 1: ON, 0: OFF
	bit 6	MFDO (terminal M3-M4) 1: ON, 0: OFF
	bit 7	MFDO (terminal M5-M6) 1: ON, 0: OFF
	bit 8 - B	Reserved
	bit C	SToF [Safe Torque OFF Hardware] 1: One of Safety input 1 (terminal H1-HC) and Safety input 2 (terminal H2-HC) is OFF (open) and the other is ON (closed).
	bit D	STo [Safe Torque OFF] 1: Both Safety input 1 (terminal H 1 - HC) and Safety input 2 (terminal H2 - HC) are OFF (open)
	bit E	ComRef status 1: Enabled
	bit F	ComCtrl status 1: Enabled
0021	Fault Description 1	
	bit 0	oC [Overcurrent], GF [Ground Fault]
	bit 1	ov [Overvoltage]
	bit 2	oL2 [Drive Overloaded]
	bit 3	oH1 [Heatsink Overheat], oH2 [External Overheat (H1-XX=B)]
	bit 4	rH [Braking Resistor Overheat], rr [Dynamic Braking Transistor Fault]
	bit 5	Reserved
	bit 6	FbL [PID Feedback Loss], FbH [Excessive PID Feedback]
	bit 7	EF0 [Option Card External Fault], EF1 to EF8 [External Fault]
	bit 8	CPFxx [Hardware Fault] Note: Includes oFx.
	bit 9	oL1 [Motor Overload], oL3, oL4 [Overtorque Detection 1/2], UL3, UL4 [Undertorque Detection 1/2]
	bit A	PGo [Encoder (PG) Feedback Loss], PGoH [Encoder (PG) Hardware Fault], oS [Overspeed], dEv [Speed Deviation]
	bit B	During Uv [Undervoltage] detection
	bit C	Uv1 [DC Bus Undervoltage], Uv2 [Control Power Undervoltage], Uv3 [Soft Charge Answerback Fault]
	bit D	LF [Output Phase Loss], PF [Input Phase Loss]
	bit E	CE [Modbus Communication Error], bUS [Option Communication Error]
bit F	oPr [Keypad Connection Fault]	

Register No. (Hex.)	Description	
0022	Fault Contents	
	bit 0	1: During data writing, during motor switching
	bit 1	Reserved
	bit 2	
	bit 3	1: Upper/Lower Limit Fault
	bit 4	1: Data Integrity Fault
	bit 5	1: During EEPROM writing
	bit 6	0: EEPROM writing 1: Change data only on the RAM Note: Enabled when H5-17 = 1 [ENTER command response @CPU BUSY = Write to RAM Only].
bit 7 - F	Reserved	
0023	U1-01 [Frequency Reference] Note: o1-03 [Frequency Display Unit Selection] sets the units.	
0024	U1-02 [Output Frequency] Note: o1-03 [Frequency Display Unit Selection] sets the units.	
0025	U1-06 [Output Voltage Ref] (units: 0.1 V) Note: Use H5-10 [Modbus Register 0025H Unit Sel] to change the setting unit.	
0026	U1-03 [Output Current] (units: 0.1 A)	
0027	U1-08 [Output Power]	
0028	U1-09 [Torque Reference]	
0029	Fault Description 2	
	bit 0	Reserved
	bit 1	GF [Ground Fault]
	bit 2	PF [Input Phase Loss]
	bit 3	LF [Output Phase Loss]
	bit 4	rH [Braking Resistor Overheat]
	bit 5	Reserved
	bit 6	oH4 [Motor Overheat Fault (PTC Input)]
bit 7 - F	Reserved	

6.3 MEMOBUS/Modbus Communications

Register No. (Hex.)	Description	
002A	Minor Fault Description 1	
	bit 0 - 1	Reserved
	bit 2	EF [FWD/REV Run Command Input Error]
	bit 3	bb [Baseblock]
	bit 4	oL3 [Overtorque 1]
	bit 5	oH [Heatsink Overheat]
	bit 6	ov [Overvoltage]
	bit 7	Uv [Undervoltage]
	bit 8	Reserved
	bit 9	CE [Modbus Communication Error]
	bit A	bUS [Option Communication Error]
	bit B	UL3/UL4 [Undertorque Detection 1/2]
	bit C	oH3 [Motor Overheat (PTC Input)]
	bit D	FbL [PID Feedback Loss], FbH [Excessive PID Feedback]
	bit E	Reserved
	bit F	CALL [Serial Comm Transmission Error]
002B	U1-10 [Input Terminal Status]	
	bit 0	1: Control circuit terminal S1 ON
	bit 1	1: Control circuit terminal S2 ON
	bit 2	1: Control circuit terminal S3 ON
	bit 3	1: Control circuit terminal S4 ON
	bit 4	1: Control circuit terminal S5 ON
	bit 5	1: Control circuit terminal S6 ON
	bit 6	1: Control circuit terminal S7 ON
	bit 7	1: Control circuit terminal S8 ON
	bit 8 - F	Reserved

Register No. (Hex.)	Description	
002C	Drive Status 2	
	bit 0	During Run 1: During Run
	bit 1	During zero speed 1: During zero speed
	bit 2	Speed agreement 1: During agreement
	bit 3	User-defined speed agreement 1: During agreement
	bit 4	Frequency Detection 1 1: Output frequency \leq L4-01
	bit 5	Frequency Detection 2 1: Output frequency \geq L4-01
	bit 6	Drive ready 1: Run ready
	bit 7	During low voltage detection 1: During detection
	bit 8	During baseblock 1: Drive output during baseblock
	bit 9	Frequency reference mode 1: No communication option, 0: Communication option
	bit A	Run command mode 1: No communication option, 0: Communication option
	bit B	During overtorque/undertorque 1, 2 detection
	bit C	Frequency reference loss 1: Loss
	bit D	Executing Auto-Restart 1: Restart Enabled
	bit E	Faults 1: Fault generated
bit F	MEMOBUS/Modbus communications timeout 1: At Timeout	
002D	U1-11 [Output Terminal Status]	
	bit 0	MFDO (terminal M1-M2) 1: ON, 0: OFF
	bit 1	MFDO (terminal M3-M4) 1: ON, 0: OFF
	bit 2	MFDO (terminal M5-M6) 1: ON, 0: OFF
	bit 3 - 6	Reserved
	bit 7	Fault relay output (terminal MA/MB-MC) 1: ON, 0: OFF
	bit 8 - F	Reserved
002E	Reserved	
002F	Frequency reference bias (Up 2/Down 2 function) (Units: 0.1%)	
0030	Reserved	
0031	U1-07 [DC Bus Voltage] (unit: 1 V)	
0032	U1-09 [Torque Reference] (unit: 1%)	
0033	Reserved	
0034	Product code 1 [ASCII], product type (GA800 =0A)	
0035	Product code 2 [ASCII], product type (GA800 =80)	

6.3 MEMOBUS/Modbus Communications

Register No. (Hex.)	Description	
0036 - 0037	Reserved	
0038	PID Feedback: Unsigned, input is equivalent to 100%/maximum output frequency (Units:0.1%)	
0039	PID Input: Signed, $\pm 100\%$ / \pm maximum output frequency (Units:0.1%)	
003A	PID Output: Signed, $\pm 100\%$ / \pm maximum output frequency (Units:0.1%)	
003B - 003C	Reserved	
003D	Communications error description Note: The drive saves the description of the communications error until you reset the fault.	
	bit 0	CRC Error
	bit 1	Data Length Error
	bit 2	Reserved
	bit 3	Parity Error
	bit 4	Overrun Error
	bit 5	Framing Error
	bit 6	Timeout
bit 7 - F	Reserved	
003E	Output Frequency	Units: min^{-1} or r/min Note: Set E2-04, E4-04, E5-04, E9-08 [Motor Pole Count].
003F		0.01% units
0040 - 004A	Used with U1-xx [Operation Status Monitors]. Refer to the U Monitor for parameter details.	
004B	U1-12 [Drive Status]	
	bit 0	1: During Run
	bit 1	1: During zero speed
	bit 2	1: During reverse
	bit 3	1: During reset signal input
	bit 4	1: During speed agreement
	bit 5	1: Drive operation ready
	bit 6	1: Minor Fault
	bit 7	1: Fault
	bit 8	1: oPExx [Operation Error] generation
	bit 9	1: Recovery from momentary power loss, 0: Power recovery
	bit A	1: Motor 2 Selection
	bit B	Reserved
	bit E	ComRef status/ NetRef status
bit F	ComCtrl status/ NetCtrl status	
004C - 007E	Use with U1-xx, U4-xx, U5-xx, U6-xx [Monitors]. Refer to "U2: Fault Trace" and "U3: Fault History" for details.	
007F	Minor fault code (Refer to "Minor fault description" for more information on the minor fault codes.)	
0080 - 0097	Use with U2-xx, U3-xx [Monitors]. Refer to "U Monitor" for details, and refer to "Fault Trace/Fault History Descriptions" for details on register values.	
0098 - 0099	U4-01 [Cumulative Ope Time] (Ex.) When U4-01 [Cumulative Ope Time] is 12345, 0098 (Hex.) = 1234 and 0099 (Hex.) = 5.	
009A - 009B	U4-03 [Cooling Fan Ope Time] (Ex.) When U4-03 [Cooling Fan Ope Time] is 12345, 009A (Hex.) = 1234 and 009B (Hex.) = 5.	
009C - 00AA	Reserved	

Register No. (Hex.)	Description	
00AB	Drive rated current Note: The unit of display is different for different models. 2004 to 2042, 4002 to 4023: 0.01 A 2056 to 2415, 4031 to 4720: 0.1 A	
00AC	U1-05 [Motor Speed]	Units: min ⁻¹ or r/min Note: Set E2-04, E4-04, E5-04, E9-08 [Motor Pole Count].
00AD		Units: 0.01%
00AE, 00AF	Reserved	
00B0	Option codes connected to CN5-A	The drive stores option codes in the register. AI-A3 = 0003 (Hex.) AO-A3 = 0004 (Hex.) DI-A3 = 0001 (Hex.) DO-A3 = 0002 (Hex.) PG-B3 = 0011 (Hex.) PG-F3 = 0021 (Hex.) PG-RT3 = 0023 (Hex.) PG-X3 = 0012 (Hex.) SI-C3 = 5343 (Hex.) SI-EM3 = 1005 (Hex.) SI-EN3 = 1006 (Hex.) SI-ET3 = 1004 (Hex.) SI-N3 = 534E (Hex.) SI-P3 = 5350 (Hex.) SI-S3 = 5353 (Hex.) SI-T3 = 5354 (Hex.) SI-W3 = 1003 (Hex.)
00B1	Reserved	
00B2	Option codes connected to CN5-B	
00B3	Option codes connected to CN5-C	
00B4	Reserved	
00B5	U1-16 [SFS Output Frequency]	Units: min ⁻¹ or r/min Note: Set E2-04, E4-04, E5-04, E9-08 [Motor Pole Count].
00B6		Units: 0.01%
00B7	Frequency reference monitor	Units: min ⁻¹ or r/min Note: Set E2-04, E4-04, E5-04, E9-08 [Motor Pole Count].
00B8		Units: 0.01%
00B9 - 00BE	Reserved	
00BF	Operation error number xx of oPExx is displayed.	

6.3 MEMOBUS/Modbus Communications

Register No. (Hex.)	Description	
00C0	Fault Description 3	
	bit 0	Reserved
	bit 1	Uv1 [DC Bus Undervoltage]
	bit 2	Uv2 [Control Power Undervoltage]
	bit 3	Uv3 [Soft Charge Answerback Fault]
	bit 4	SC [Short Circuit/IGBT Failure]
	bit 5	GF [Ground Fault]
	bit 6	oC [Overcurrent]
	bit 7	ov [Overvoltage]
	bit 8	oH [Heatsink Overheat]
	bit 9	oH1 [Heatsink Overheat]
	bit A	oL1 [Motor Overload]
	bit B	oL2 [Drive Overloaded]
	bit C	oL3 [Overtorque Detection 1]
	bit D	oL4 [Overtorque Detection 2]
	bit E	rr [Dynamic Braking Transistor]
	bit F	rH [Braking Resistor Overheat]
00C1	Fault Description 4	
	bit 0	EF3 [External Fault (Terminal S3)]
	bit 1	EF4 [External Fault (Terminal S4)]
	bit 2	EF5 [External Fault (Terminal S5)]
	bit 3	EF6 [External Fault (Terminal S6)]
	bit 4	EF7 [External Fault (Terminal S7)]
	bit 5	EF8 [External Fault (Terminal S8)]
	bit 6	Reserved
	bit 7	oS [Overspeed]
	bit 8	dEv [Speed Deviation]
	bit 9	PGo [Encoder (PG) Feedback Loss]
	bit A	PF [Input Phase Loss]
	bit B	LF [Output Phase Loss]
	bit C	oH3 [Motor Overheat (PTC Input)]
	bit D	oPr [Keypad Connection Fault]
	bit E	Err [EEPROM Write Error]
	bit F	oH4 [Motor Overheat Fault (PTC Input)]

Register No. (Hex.)	Description	
00C2	Fault Description 5	
	bit 0	CE [Modbus Communication Error]
	bit 1	bUS [Option Communication Error]
	bit 2 - 3	Reserved
	bit 4	CF [Control Fault]
	bit 5	SvE [Zero Servo Fault]
	bit 6	EF0 [Option Card External Fault]
	bit 7	FbL [PID Feedback Loss]
	bit 8	UL3 [Undertorque Detection 1]
	bit 9	UL4 [Undertorque Detection 2]
	bit A	oL7 [High Slip Braking Overload]
	bit B - E	Reserved
	bit F	Hardware Fault (includes <i>oFx</i> fault)
	00C3	Fault Description 6
bit 0		Reserved
bit 1		dv1 [Z Pulse Fault]
bit 2		dv2 [Z Pulse Noise Fault Detection]
bit 3		dv3 [Inversion Detection]
bit 4		dv4 [Inversion Prevention Detection]
bit 5		LF2 [Output Current Imbalance]
bit 6		STPo [Motor Step-Out Detected]
bit 7		PGoH [Encoder (PG) Hardware Fault]
bit 8		E5 [MECHATROLINK Watchdog Timer Err]
bit 9		Reserved
bit A		SEr [Speed Search Retries Exceeded]
bit B - F		Reserved
00C4		Fault Description 7
	bit 0	FbH [Excessive PID Feedback]
	bit 1	EF1 [External Fault (Terminal S1)]
	bit 2	EF2 [External Fault (Terminal S2)]
	bit 3	oL5 [Mechanical Weakening Detection 1]
	bit 4	UL5 [Mechanical Weakening Detection 2]
	bit 5	CoF [Current Offset Fault]
	bit 6 - 7	Reserved
	bit 8	dWFL [DriveWorksEZ Fault]
	bit 9	dWF1 [EEPROM Memory DWEZ Data Error]
	bit A - C	Reserved
	bit D	rF [Braking Resistor Fault]
	bit E	boL [Braking Transistor Overload Fault]
	bit F	Reserved

6.3 MEMOBUS/Modbus Communications

Register No. (Hex.)	Description	
00C5	Fault Description 8	
	bit 0	LSo [LSO Fault]
	bit 1	nSE [Node Setup Error]
	bit 2 - 9	Reserved
	bit A	dv7 [Polarity Judge Timeout]
	bit B - F	Reserved
00C6 - 00C7	Reserved	
00C8	Minor Fault Description 2	
	bit 0	Uv [Undervoltage]
	bit 1	ov [Overvoltage]
	bit 2	oH [Heatsink Overheat]
	bit 3	Overheat Alarm (oH2)
	bit 4	oL3 [Overtorque 1]
	bit 5	oL4 [Overtorque 2]
	bit 6	EF [FWD/REV Run Command Input Error]
	bit 7	bb [Baseblock]
	bit 8	EF3 [External Fault (Terminal S3)]
	bit 9	EF4 [External Fault (Terminal S4)]
	bit A	EF5 [External Fault (Terminal S5)]
	bit B	EF6 [External Fault (Terminal S6)]
	bit C	EF7 [External Fault (Terminal S7)]
	bit D	EF8 [External Fault (Terminal S8)]
	bit E	Reserved
bit F	oS [Overspeed]	
00C9	Minor Fault Description 3	
	bit 0	dEv [Speed Deviation]
	bit 1	PGo [Encoder (PG) Feedback Loss]
	bit 2	oPr [Keypad Connection Fault]
	bit 3	CE [Modbus Communication Error]
	bit 4	bUS [Option Communication Error]
	bit 5	CALL [Serial Comm Transmission Error]
	bit 6	oL1 [Motor Overload]
	bit 7	oL2 [Drive Overloaded]
	bit 8	Reserved
	bit 9	EF0 [Option Card External Fault]
	bit A	rUn [Motor Switch during Run]
	bit B	Reserved
	bit C	CALL [Serial Comm Transmission Error]
	bit D	UL3 [Undertorque Detection 1]
	bit E	UL4 [Undertorque Detection 2]
bit F	SE [Modbus Test Mode Error]	

Register No. (Hex.)	Description	
00CA	Minor Fault Description 4	
	bit 0	Reserved
	bit 1	oH3 [Motor Overheat (PTC Input)]
	bit 2 - 5	Reserved
	bit 6	FbL [PID Feedback Loss]
	bit 7	FbH [Excessive PID Feedback]
	bit 8	Reserved
	bit 9	dnE [Drive Disabled]
	bit A	PGoH [Encoder (PG) Hardware Fault]
	bit B - F	Reserved
00CB	Minor Fault Description 5	
	bit 0	E5 [MECHATROLINK Watchdog Timer Err]
	bit 1	AEr [Station Address Setting Error]
	bit 2	CyC [MECHATROLINK CommCycleSettingErr]
	bit 3	HCA [High Current Alarm]
	bit 4	LT-1 [Cooling Fan Maintenance Time]
	bit 5	LT-2 [Capacitor Maintenance Time]
	bit 6 - 7	Reserved
	bit 8	EF1 [External Fault (Terminal S1)]
	bit 9	EF2 [External Fault (Terminal S2)]
	bit A	SToF [Safe Torque OFF Hardware]
	bit B	Reserved
	bit C	oL5 [Mechanical Weakening Detection 1]
	bit D	UL5 [Mechanical Weakening Detection 2]
	bit E - F	Reserved
00CC	Minor Fault Description 6	
	bit 0	Reserved
	bit 1	TrPC [IGBT Maintenance Time (90%)]
	bit 2	LT-3 [SoftChargeBypassRelay MainteTime]
	bit 3	LT-4 [IGBT Maintenance Time (50%)]
	bit 4	boL [Braking Transistor Overload]
	bit 5 - 7	Reserved
	bit 8	dWAL [DriveWorksEZ Fault]
	bit 9 - F	Reserved
00CD - 00CF	Reserved	

6.3 MEMOBUS/Modbus Communications

Register No. (Hex.)	Description	
00D0	CPF Contents 1	
	bit 0 - 1	Reserved
	bit 2	CPF02 [Control Circuit Error]
	bit 3	CPF03 [Control Circuit Error]
	bit 4 - 5	Reserved
	bit 6	CPF06 [Control Circuit Error]
	bit 7	CPF07 [Control Circuit Error]
	bit 8	CPF08 [Control Circuit Error]
	bit 9	Reserved
	bit A	CPF10 [Control Circuit Error]
	bit B	CPF11 [Control Circuit Error]
	bit C	CPF12 [Control Circuit Error]
	bit D	CPF13 [Control Circuit Error]
	bit E	CPF14 [Control Circuit Error]
	bit F	Reserved
00D1	CPF Contents 2	
	bit 0	CPF16 [Control Circuit Error]
	bit 1	CPF17 [Control Circuit Error]
	bit 2	CPF18 [Control Circuit Error]
	bit 3	CPF19 [Control Circuit Error]
	bit 4	CPF20 [Control Circuit Error]
	bit 5	CPF21 [Control Circuit Error]
	bit 6	CPF22 [Control Circuit Error]
	bit 7	CPF23 [Control Circuit Error]
	bit 8	CPF24 [Control Circuit Error]
	bit 9	Reserved
	bit A	CPF26 [Control Circuit Error]
	bit B	CPF27 [Control Circuit Error]
	bit C	CPF28 [Control Circuit Error]
	bit D	CPF29 [Control Circuit Error]
bit E	CPF30 [Control Circuit Error]	
bit F	CPF31 [Control Circuit Error]	
00D2	CPF Contents 3	
	bit 0	CPF32 [Control Circuit Error]
	bit 1	CPF33 [Control Circuit Error]
	bit 2	CPF34 [Control Circuit Error]
	bit 3	CPF35 [Control Circuit Error]
	bit 4	CPF36 [Control Circuit Error]
	bit 5	CPF37 [Control Circuit Error]
	bit 6	CPF38 [Control Circuit Error]
	bit 7	CPF39 [Control Circuit Error]
bit 8 - F	Reserved	
00D3 - 00D7	Reserved	

Register No. (Hex.)	Description	
00D8	oFA0x Description (CN5-A)	
	bit 0	oFA00 [Option Not Compatible with Port]
	bit 1	oFA01 [Option Fault/Connection Error]
	bit 2 - 4	Reserved
	bit 5	oFA05 [Option A/D Error]
	bit 6	oFA06 [Option Communication Error]
	bit 7 - F	Reserved
00D9	oFA1x Description (CN5-A)	
	bit 0	oFA10 [Option RAM Error]
	bit 1	oFA11 [Option Ope Mode Error]
	bit 2	oFA12 [Drive Receive CRC Error]
	bit 3	oFA13 [Drive Receive Frame Error]
	bit 4	oFA14 [Drive Receive Abort Error]
	bit 5	oFA15 [Option Receive CRC Error]
	bit 6	oFA16 [Option Receive Frame Error]
	bit 7	oFA17 [Option Receive Abort Error]
bit 8 - F	Reserved	
00DA	Reserved	
00DB	oFA3x Description (CN5-A)	
	bit 0	oFA30 [COM ID Error]
	bit 1	oFA31 [Type Code Error]
	bit 2	oFA32 [SUM Check Error]
	bit 3	oFA33 [Option Receive Time Over]
	bit 4	oFA34 [Memobus Time Over]
	bit 5	oFA35 [Drive Timeout Waiting for Response]
	bit 6	oFA36 [CI Check Error]
	bit 7	oFA37 [Drive Timeout Waiting for Response]
	bit 8	oFA38 [Control Reference Error]
	bit 9	oFA39 [Drive Timeout Waiting for Response]
	bit A	oFA40 [CtrlResSel 1Err]
	bit B	oFA41 [Drive Timeout Waiting for Response]
	bit C	oFA42 [CtrlResSel 2Err]
	bit D	oFA43 [Drive Timeout Waiting for Response]
bit E - F	Reserved	
00DC	oFb0x Description (CN5-B)	
	bit 0	oFb00 [Option Not Compatible with Port]
	bit 1	oFb01 [Option Fault/Connection Error]
	bit 2	oFb02 [Duplicate Options]
	bit 3 - 4	Reserved
	bit 5	oFb05 [Opt A/D ERR]
	bit 6	oFb06 [Opt Comm ERR]
bit 7 - F	Reserved	

6.3 MEMOBUS/Modbus Communications

Register No. (Hex.)	Description	
00DD	oFb1x Description (CN5-B)	
	bit 0	oFb10 [Opt RAM ERR]
	bit 1	oFb11 [Opt Ope Mode ERR]
	bit 2	oFb12 [DRV RCV CRC ERR]
	bit 3	oFb13 [DRV RCV FrameERR]
	bit 4	oFb14 [DRV RCV AbortERR]
	bit 5	oFb15 [Option Receive CRC Error]
	bit 6	oFb16 [Option Receive Frame Error]
	bit 7	oFb17 [Option Receive Abort Error]
	bit 8 - F	Reserved
00DE - 00DF	Reserved	
00E0	oFb3x Description (CN5-B)	
	bit 0	oFb30 [Comm. ID Error]
	bit 1	oFb31 [Model Code Error]
	bit 2	oFb32 [SUM Check Error]
	bit 3	oFb33 [Option Receive Time Over]
	bit 4	oFb34 [Memobus Time Over]
	bit 5	oFb35 [Drive Receive Time Over]
	bit 6	oFb36 [CI Check Error]
	bit 7	oFb37 [Drive Receive Time Over 2]
	bit 8	oFb38 [Control Reference Error]
	bit 9	oFb39 [Drive Receive Time Over 3]
	bit A	oFb40 [CtrlResSel 1Err]
	bit B	oFb41 [Drive Receive Time Over 4]
	bit C	oFb42 [CtrlResSel 2Err]
	bit D	oFb43 [Drive Receive Time Over 5]
	bit E - F	Reserved
00E1	oFC0x Description (CN5-C)	
	bit 0	oFC00 [Option Not Compatible with Port]
	bit 1	oFC01 [Option Fault/Connection Error]
	bit 2	oFC02 [Duplicate Options]
	bit 3 - 4	Reserved
	bit 5	oFC05 [Option A/D Error]
	bit 6	oFC06 [Option Communication Error]
	bit 7 - F	Reserved

Register No. (Hex.)	Description	
00E2	oFC1x Description (CN5-C)	
	bit 0	oFC10 [Option RAM Error]
	bit 1	oFC11 [Option Ope Mode Error]
	bit 2	oFC12 [Drive Receive CRC Error]
	bit 3	oFC13 [Drive Receive Frame Error]
	bit 4	oFC14 [Drive Receive Abort Error]
	bit 5	oFC15 [Option Receive CRC Error]
	bit 6	oFC16 [Option Receive Frame Error]
	bit 7	oFC17 [Option Receive Abort Error]
bit 8 - F	Reserved	
00E3	Reserved	
00E4	oFC5x Description (CN5-C)	
	bit 0	oFC50 [Encoder Option A/D Conv Error]
	bit 1	oFC51 [EncOpAnlgCrctErr]
	bit 2	oFC52 [Encoder Option Comm Timeout]
	bit 3	oFC53 [Encoder Option Comm Data Fault]
	bit 4	oFC54 [Encoder Error]
	bit 5	oFC55 [Resolver Error]
bit 6 - F	Reserved	
00E5	Minor Fault Description 9	
	bit 0	EP24v [External Power 24V Supply]
	bit 1 - 3	Reserved
	bit 4	bAT [Keypad Battery Low Voltage]
	bit 5	Reserved
	bit 6	CP1 [Comparator 1 Limit Error]
	bit 7	CP2 [Comparator 2 Limit Error]
	bit 8	TiM [Keypad Time Not Set]
	bit 9	bCE [Bluetooth Communication Error]
bit A - F	Reserved	
00E6 - 00E9	Reserved	
00EA	Fault Description 11	
	bit 0	TiM [Keypad Time Not Set]
	bit 1	bAT [Keypad Battery Low Voltage]
	bit 2 - D	Reserved
	bit E	SCF [Safety Circuit Fault]
bit F	Reserved	
00EB - 00ED	Reserved	
00EE	Fault Description 12	
	bit 0 - 2	Reserved
	bit 3	CP1 [Comparator 1 Limit Error]
	bit 4	CP2 [Comparator 2 Limit Error]
	bit 5	bCE [Bluetooth Communication Fault]
bit 6 - F	Reserved	

6.3 MEMOBUS/Modbus Communications

Register No. (Hex.)	Description
00EF - 00FA	Reserved
00FB	Output Current Note: The unit of display is different for different models. 2004 to 2042, 4002 to 4023: 0.01 A 2056 to 2415, 4031 to 4720: 0.1 A

■ Broadcast Messages

Broadcast messages are available as read-only.

The undefined bit signal in the broadcast operation signal uses the local data signal.

Table 6.13 Broadcast Messages for MEMOBUS/Modbus Communication

Register No. (Hex.)	Description	
0001	Operation signal	
	bit 0	Run command 1: Run, 0: Stop
	bit 1	Reverse run command 1: Reverse, 0: Forward run
	bit 2 - 3	Reserved
	bit 4	External fault 1: EF0 [Option Card External Fault]
	bit 5	Fault Reset 1: Reset command
	bit 6 - B	Reserved
	bit C	MFDI terminal S5 input
	bit D	MFDI terminal S6 input
	bit E	MFDI terminal S7 input
	bit F	MFDI terminal S8 input
0002	Frequency reference	30000/100%

■ Fault Trace/Fault History Contents

Table 6.14 lists the fault codes that the commands from monitors [*U2-xx*, *U3-xx*] read.

Table 6.14 Fault Trace/Fault History Contents

Fault Code (Hex.)	Name	Fault Code (Hex.)	Name
0002	Uv1 [DC Bus Undervoltage]	000E	oL4 [Overtorque Detection 2]
0003	Uv2 [Control Power Undervoltage]	000F	rr [Dynamic Braking Transistor]
0004	Uv3 [Soft Charge Answerback Fault]	0010	rH [Braking Resistor Overheat]
0005	SC [Short Circuit/IGBT Failure]	0011	EF3 [External Fault (Terminal S3)]
0006	GF [Ground Fault]	0012	EF4 [External Fault (Terminal S4)]
0007	oC [Overcurrent]	0013	EF5 [External Fault (Terminal S5)]
0008	ov [Overvoltage]	0014	EF6 [External Fault (Terminal S6)]
0009	oH [Heatsink Overheat]	0015	EF7 [External Fault (Terminal S7)]
000A	oH1 [Heatsink Overheat]	0016	EF8 [External Fault (Terminal S8)]
000B	oL1 [Motor Overload]	0017	Reserved
000C	oL2 [Drive Overloaded]	0018	oS [Overspeed]
000D	oL3 [Overtorque Detection 1]	0019	dEv [Speed Deviation]

Fault Code (Hex.)	Name
001A	PGo [Encoder (PG) Feedback Loss]
001B	PF [Input Phase Loss]
001C	LF [Output Phase Loss]
001D	oH3 [Motor Overheat (PTC Input)]
001E	oPr [Keypad Connection Fault]
001F	Err [EEPROM Write Error]
0020	oH4 [Motor Overheat Fault (PTC Input)]
0021	CE [Modbus Communication Error]
0022	bUS [Option Communication Error]
0025	CF [Control Fault]
0026	SvE [Zero Servo Fault]
0027	EF0 [Option Card External Fault]
0028	FbL [PID Feedback Loss]
0029	UL3 [Undertorque Detection 1]
002A	UL4 [Undertorque Detection 2]
002B	oL7 [High Slip Braking Overload]
0030	Includes oFx Fault [Hardware Fault]
0032	dv1 [Z Pulse Fault]
0033	dv2 [Z Pulse Noise Fault Detection]
0034	dv3 [Inversion Detection]
0035	dv4 [Inversion Prevention Detection]
0036	LF2 [Output Current Imbalance]
0037	STPo [Motor Step-Out Detected]
0038	PGoH [Encoder (PG) Hardware Fault]
0039	E5 [MECHATROLINK Watchdog Timer Err]
003B	SEr [Speed Search Retries Exceeded]
0041	FbH [Excessive PID Feedback]
0042	EF1 [External Fault (Terminal S1)]
0043	EF2 [External Fault (Terminal S2)]
0044	oL5 [Mechanical Weakening Detection 1]
0045	UL5 [Mechanical Weakening Detection 2]
0046	CoF [Current Offset Fault]

Fault Code (Hex.)	Name
0049	dWFL [DriveWorksEZ Fault]
004A	dWF1 [EEPROM Memory DWEZ Data Error]
004B	dWF2 [DriveWorksEZ Fault 2]
004C	dWF3 [DriveWorksEZ Fault 3]
004E	rF [Braking Resistor Fault]
004F	boL [Braking Transistor Overload Fault]
0051	LSo [LSo Fault]
0052	nSE [Node Setup Error]
005B	dv7 [Polarity Judge Timeout]
0083, 0084 0087 - 0089 008C - 008F 0091 - 0099 009B - 00A8	CPF02 - CPF39 [Control Circuit Error]
0101	oFA00 [Option Not Compatible with Port]
0102, 0106, 0107 0111 - 0118 0131 - 013E	oFA01 - oFA43 [Option Fault/Connection Error]
0201	oFb00 [Option Not Compatible with Port]
0202, 0203, 0206, 0207 0211 - 0218 0231 - 023E	oFb01 - oFb43 [Option Fault/Connection Error]
0301	oFC00 [Option Not Compatible with Port]
0302, 0303, 0306, 0307 0311 - 0318 0351 - 0356	oFC01 - oFC55 [Option Fault/Connection Error]
0401	TiM [Keypad Time Not Set]
0402	bAT [Keypad Battery Low Voltage]
040F	SCF [Safety Circuit Fault]
0413	FAn1 [Drive Cooling Fan Failure]
0414	CP1 [Comparator 1 Limit Error]
0415	CP2 [Comparator 2 Limit Error]
0416	bCE [Bluetooth Communication Fault]

■ Minor Fault/Alarm Contents

Table 6.15 lists the minor fault/alarm codes that communications register (007F (Hex.)) reads.

Table 6.15 Minor Fault/Alarm Contents (007 (Hex.))

Minor Fault/Alarm Code (Hex.)	Name
0001	Uv [Undervoltage]
0002	ov [Overvoltage]
0003	oH [Heatsink Overheat]
0004	Overheat Alarm (oH2)
0005	oL3 [Overtorque 1]

Minor Fault/Alarm Code (Hex.)	Name
0006	oL4 [Overtorque 2]
0007	EF [FWD/REV Run Command Input Error]
0008	bb [Baseblock]
0009	EF3 [External Fault (Terminal S3)]
000A	EF4 [External Fault (Terminal S4)]

6.3 MEMOBUS/Modbus Communications

Minor Fault/ Alarm Code (Hex.)	Name	Minor Fault/ Alarm Code (Hex.)	Name
000B	EF5 [External Fault (Terminal S5)]	0031	E5 [MECHATROLINK Watchdog Timer Err]
000C	EF6 [External Fault (Terminal S6)]	0032	AEr [Station Address Setting Error]
000D	EF7 [External Fault (Terminal S7)]	0033	CyC [MECHATROLINK CommCycleSettingErr]
000E	EF8 [External Fault (Terminal S8)]	0034	HCA [High Current Alarm]
0010	oS [Overspeed]	0035	LT-1 [Cooling Fan Maintenance Time]
0011	dEv [Speed Deviation]	0036	LT-2 [Capacitor Maintenance Time]
0012	PGo [Encoder (PG) Feedback Loss]	0039	EF1 [External Fault (Terminal S1)]
0014	CE [Modbus Communication Error]	003A	EF2 [External Fault (Terminal S2)]
0015	bUS [Option Communication Error]	003B	SToF [Safe Torque OFF Hardware]
0016	CALL [Serial Comm Transmission Error]	003D	oL5 [Mechanical Weakening Detection 1]
0017	oL1 [Motor Overload]	003E	UL5 [Mechanical Weakening Detection 2]
0018	oL2 [Drive Overloaded]	0042	TrPC [IGBT Maintenance Time (90%)]
001A	EF0 [Option Card External Fault]	0043	LT-3 [SoftChargeBypassRelay MainteTime]
001B	rUn [Motor Switch during Run]	0044	LT-4 [IGBT Maintenance Time (50%)]
001D	CALL [Serial Comm Transmission Error]	0045	boL [Braking Transistor Overload]
001E	UL3 [Undertorque Detection 1]	0049	dWAL [DriveWorksEZ Alarm]
001F	UL4 [Undertorque Detection 2]	004A	dWA2 [DriveWorksEZ Alarm 2]
0020	SE [Modbus Test Mode Error]	004B	dWA3 [DriveWorksEZ Alarm 3]
0021	L24v [Loss of External Power 24 Supply]	0081	EP24v [External Power 24V Supply]
0022	oH3 [Motor Overheat (PTC Input)]	0085	bAT [Keypad Battery Low Voltage]
0027	FbL [PID Feedback Loss]	0087	CP1 [Comparator 1 Limit Error]
0028	FbH [Excessive PID Feedback]	0088	CP2 [Comparator 2 Limit Error]
002A	dnE [Drive Disabled]	0089	TiM [Keypad Time Not Set]
002B	PGoH [Encoder (PG) Hardware Fault]	008A	bCE [Bluetooth Communication Error]

◆ Error Codes

■ MEMOBUS/Modbus Communications Error Code List

Table 6.16 lists the MEMOBUS/Modbus communications error codes.

When an error occurs, remove the cause of the error and restart communications.

Table 6.16 MEMOBUS/Modbus Communications Error Codes

Error Code (Hex.)	Name	Cause
01	Function Code Error	The PLC set a function code that was not 03, 08, or 10 (Hex.)
02	Register Number Error	<ul style="list-style-type: none"> The register number that is trying to access is not registered. A starting number that was not 0001 or 0002 (Hex.) was set when broadcasting.
03	Bit Count Error	<ul style="list-style-type: none"> Read and write data quantities are more than the 1 to 16 range. (Command message data quantity is disabled.) The data that was read from non-consecutive holding registers contained more than 120 bytes. The data to be written to non-consecutive holding registers contained more than 60 bytes. In the write mode, the number of bytes in the message is not the number of data × 2.
21	Data Setting Error	<ul style="list-style-type: none"> Writing control data or parameters made the settings go out of the permitted setting range. A parameter setting error occurred when writing a parameter.

Error Code (Hex.)	Name	Cause
22	Write Mode Error	<ul style="list-style-type: none"> • Tried to write a disabled parameter during run. • When there was a CPF06 [Control Circuit Error], the master tried to write a parameter other than one of these: <ul style="list-style-type: none"> – A1-00 [Language Selection] – A1-01 [Access Level Selection] – A1-02 [Control Method Selection] – A1-03 [Initialize Parameters] – A1-04 [Password] – A1-05 [Password Setting] – E1-03 [V/f Pattern Selection] – o2-04 [Drive Model (KVA) Selection] • Writes the read-only data.
23	DC Bus Undervoltage Write Error	During U_v [DC Bus Undervoltage], a U_v write disabled parameter was written.
24	Error Writing Data During Parameter Processing	Tried to write a parameter from the master during parameter processing on the drive side.
25	Writing into EEPROM Disabled	Writing into EEPROM write is disabled, but EEPROM write was executed from MEMOBUS/Modbus communications. When this error occurs, the keypad shows a message and the drive continues operation.

■ No Response from Slave

The slave ignores the command message from the master and will not send a response message in these conditions:

- When a communications error (overrun, framing, parity, CRC-16) is detected in the command message.
- When the slave address in the command message and the slave address for the drive side do not agree (Use H5-01 [Drive Node Address] to set the slave address of the drive)
- When the time interval between the data of which the message is composed is longer than 24 bits
- When the data length for the command message is not accurate

Note:

- If the keypad shows CALL [Serial Comm Transmission Error], refer to “Troubleshooting” to remove the cause of the error, and try to do communications again. If the keypad does not show CALL, check U1-19 [MEMOBUS/Modbus Error Code] for the error and error type.
- If you execute the write function code when the slave address in the command message is 00 (Hex.), all of the slaves will execute the write command, but they will not send response messages to the master.

Troubleshooting

7.1	Section Safety	308
7.2	Types of Faults, Minor Faults, Alarms, and Errors	310
7.3	List of Fault, Minor Fault, Alarm, and Error Codes	311
7.4	Fault	317
7.5	Minor Faults/Alarms	337
7.6	Parameter Setting Errors.....	347
7.7	Auto-Tuning Errors	353
7.8	Backup Function Operating Mode Display and Errors.....	358
7.9	Diagnosing and Resetting Faults.....	360
7.10	Troubleshooting Without Fault Display.....	362

7.1 Section Safety

⚠ DANGER

Electrical Shock Hazard

Do not examine, connect, or disconnect wiring on an energized drive. Before servicing, disconnect all power to the equipment and wait for the time specified on the warning label at a minimum. The internal capacitor stays charged after the drive is de-energized. The charge indicator LED extinguishes when the DC bus voltage decreases below 50 Vdc. When all indicators are OFF, remove the covers before measuring for dangerous voltages to make sure that the drive is safe.

If you do work on the drive when it is energized, it will cause serious injury or death from electrical shock. The drive has internal capacitors that stay charged after you de-energize the drive.

⚠ WARNING

Electrical Shock Hazard

Do not operate the drive when covers are missing. Replace covers and shields before you operate the drive. Use the drive only as specified by the instructions.

Some figures in this section include drives without covers or safety shields to more clearly show the inside of the drive. If covers or safety shields are missing from the drive, it can cause serious injury or death.

Always ground the motor-side grounding terminal.

If you do not ground the equipment correctly, it can cause serious injury or death if you touch the motor case.

After the drive blows a fuse or trips a GFCI, do not immediately energize the drive or operate peripheral devices. Wait for the time specified on the warning label at a minimum and make sure that all indicators are OFF. Then check the wiring and peripheral device ratings to find the cause of the problem. If you do not know the cause of the problem, contact Yaskawa before you energize the drive or peripheral devices.

If you do not fix the problem before you operate the drive or peripheral devices, it can cause serious injury or death.

Only let approved personnel install, wire, maintain, examine, replace parts, and repair the drive.

If personnel are not approved, it can cause serious injury or death.

Do not wear loose clothing or jewelry when you do work on the drive. Tighten loose clothing and remove all metal objects, for example watches or rings.

Loose clothing can catch on the drive and jewelry can conduct electricity and cause serious injury or death.

Do not remove covers or touch circuit boards while the drive is energized.

If you touch the internal components of an energized drive, it can cause serious injury or death.

Do not modify the drive body or drive circuitry.

Modifications to drive body and circuitry can cause serious injury or death, will cause damage to the drive, and will void the warranty. Yaskawa is not responsible for modifications of the product made by the user.

Fire Hazard

Tighten all terminal screws to the correct tightening torque.

Connections that are too loose or too tight can cause incorrect operation and damage to the drive. Incorrect connections can also cause death or serious injury from fire.

Tighten screws at an angle in the specified range shown in this manual.

If you tighten the screws at an angle not in the specified range, you can have loose connections that can cause damage to the terminal block or start a fire and cause serious injury or death.

Damage to Equipment

Do not apply incorrect voltage to the main circuit of the drive. Operate the drive in the specified range of the input voltage on the drive nameplate.

Voltages that are higher than the permitted nameplate tolerance can cause damage to the drive.

⚠ WARNING**Fire Hazard**

Do not put flammable or combustible materials on top of the drive and do not install the drive near flammable or combustible materials. Attach the drive to metal or other noncombustible material.

Flammable and combustible materials can start a fire and cause serious injury or death.

Crush Hazard

Wear eye protection when you do work on the drive.

If you do not use correct safety equipment, it can cause serious injury or death.

Use a crane or hoist to move large drives when necessary.

If you try to move a large drive without a crane or hoist, it can cause serious injury or death.

NOTICE**Damage to Equipment**

When you touch the drive and circuit boards, make sure that you observe correct electrostatic discharge (ESD) procedures.

If you do not follow procedures, it can cause ESD damage to the drive circuitry.

Do not break the electrical connection between the drive and the motor when the drive is outputting voltage.

Incorrect equipment sequencing can cause damage to the drive.

Make sure that all connections are correct after you install the drive and connect peripheral devices.

Incorrect connections can cause damage to the drive.

Note:

Do not use unshielded wire for control wiring. Use shielded, twisted-pair wires and ground the shield to the ground terminal of the drive. Unshielded wire can cause electrical interference and unsatisfactory system performance.

7.2 Types of Faults, Minor Faults, Alarms, and Errors

If the drive or motor do not operate correctly, check the drive keypad for a code or message.



If problems occur that are not identified in this manual, contact the nearest Yaskawa representative with this information:

- Drive model
- Drive software version
- Date of purchase
- Description of the problem (such as failure conditions)

Table 7.1 contains descriptions of the different types of faults, minor faults, alarms, and errors that can occur during drive operation.

Contact Yaskawa if there is damage to the drive. Contact information is on the back cover of the manual.

Table 7.1 Types of Faults, Minor Faults, Alarms, and Errors

Type	Drive Response
Faults	<p>When the drive detects a fault, it will cause these conditions:</p> <ul style="list-style-type: none"> • The keypad shows the fault code and  and ALM/ERR of the LED Status Ring illuminate continuously. • The drive shuts off output, and the motor coasts to a stop. Some faults let the user select a motor stopping method. • Fault relay output MA-MC will turn ON, and MB-MC will turn OFF. <p>The drive will not operate until you clear the fault with a Fault Reset and the drive goes back to usual status.</p>
Minor Faults/Alarms	<p>When the drive detects a minor fault or an alarm, it will cause these conditions:</p> <ul style="list-style-type: none"> • The keypad shows the alarm code and  and ALM/ERR on the LED Status Ring flash. • The drive will continue to operate the motor. Some alarms let the user select a motor stopping method. • If the drive detects a minor fault, the terminal set to H2-01 to H2-03 = 10 [MFDO Function Select = Alarm] will switch ON. If you do not set parameters H2-01 to H2-03, the drive will not trigger MFDO terminals when it detects a minor fault. • The drive will not output a minor fault signal when it detects an alarm. <p>It is not necessary to do Fault Reset.</p>
Operation Errors	<p>An error occurs when parameter settings do not agree or a parameter combination is incorrect. The drive will not operate until you set the parameters correctly.</p> <p>When the drive detects an operation error, these conditions will result:</p> <ul style="list-style-type: none"> • The keypad shows the error code. • Multi-function outputs do not output an alarm signal. <p>Find the parameters that caused the error and correct the settings.</p>
Auto-Tuning Errors	<p>An error occurs during Auto-Tuning.</p> <p>When the drive detects a tuning error, it will cause these conditions:</p> <ul style="list-style-type: none"> • The keypad shows the error code. • Multi-function outputs do not output an alarm signal. • The motor coasts to stop. <p>Remove the cause of the error and do Auto-Tuning again.</p>
Copy Function Errors	<p>An error occurs when you use the keypad for a backup, restore, or verify operation.</p> <p>When the drive detects a copy function error, it will cause these conditions:</p> <ul style="list-style-type: none"> • The keypad shows the error code. • Multi-function outputs do not output an alarm signal. <p>Push a key on the keypad to clear the error. Remove the cause of the error and try the backup, restore, or verify operation again.</p>

7.3 List of Fault, Minor Fault, Alarm, and Error Codes

Table 7.2 shows the possible fault, minor fault, alarm, and error codes.

The display codes are in alphabetical order. Search the table for the code shown on the keypad, and identify its causes and possible solutions.

Note:

The number in parentheses adjacent to the code in the table identifies the fault code or minor fault code (hex. number) that was read during MEMOBUS/Modbus communications.

Example: AEr (0032)

Table 7.2 List of Fault, Minor Fault, Alarm, and Error Codes

Display (Hex.)	Name	ALM LED	Type	Ref.
AEr (0032)	Station Address Setting Error	Flashing	Alarm	337
bAT (0085)	Keypad Battery Low Voltage	Flashing	Alarm	337
bAT (0402)	Keypad Battery Low Voltage	Illuminated	Faults	317
bb (0008)	Baseblock	Flashing	An alarm	337
bCE (008A)	Bluetooth Communication Error	Flashing	Alarm	337
bCE (0416)	Bluetooth Communication Fault	Illuminated	Faults	317
boL (0045)	Braking Transistor Overload	Flashing	Alarm	337
boL (004F)	Braking Transistor Overload Fault	Illuminated	Faults	317
bUS (0015)	Option Communication Error	Flashing	Alarm	337
bUS (0022)	Option Communication Error	Illuminated	Faults	317
CALL (001D)	Serial Comm Transmission Error	Flashing	Alarm	338
CE (0014)	Modbus Communication Error	Flashing	Alarm	338
CE (0021)	Modbus Communication Error	Illuminated	Faults	317
CF (0025)	Control Fault	Illuminated	Faults	318
CoF (0046)	Current Offset Fault	Illuminated	Faults	318
CP1 (0087)	Comparator 1 Limit Error	Flashing	Alarm	338
CP1 (0414)	Comparator 1 Limit Error	Illuminated	Faults	318
CP2 (0088)	Comparator 2 Limit Error	Flashing	Alarm	338
CP2 (0415)	Comparator 2 Limit Error	Illuminated	Faults	319
CPEr	Control Mode Mismatch	-	Backup Function Runtime Errors	358
CPF00, CPF01 CPF02, CPF03 (0083, 0084) CPF07, CPF08 (0088, 0089) CPF11 - CPF14 (008C - 008F) CPF16 - CPF24 (0091 - 0099) CPF26 - CPF39 (009B - 00A8)	Control Circuit Error	Illuminated	Faults	319
CPF06 (0087)	EEPROM Memory Data Error	Illuminated	Faults	319
CPF25 (009A)	Terminal Board not Connected	Illuminated	Faults	319
CPyE	Error Writing Data	-	Backup Function Runtime Errors	358
CrST	Remove RUN Command to Reset	Flashing	Not an alarm.	339
CSEr	Control Mode Mismatch	-	Backup Function Runtime Errors	358
CyC (0033)	MECHATROLINK CommCycleSettingErr	Flashing	Alarm	339
CyPo (0029)	Cycle Power to Accept Changes	Flashing	Alarm	339
dEv (0011)	Speed Deviation	Flashing	Alarm	339
dEv (0019)	Speed Deviation	Illuminated	Faults	319
dFPS	Drive Model Mismatch	-	Backup Function Runtime Errors	358

7.3 List of Fault, Minor Fault, Alarm, and Error Codes

Display (Hex.)	Name	ALM LED	Type	Ref.
dnE (002A)	Drive Disabled	Flashing	Alarm	339
dv1 (0032)	Z Pulse Fault	Illuminated	Faults	319
dv2 (0033)	Z Pulse Noise Fault Detection	Illuminated	Faults	320
dv3 (0034)	Inversion Detection	Illuminated	Faults	320
dv4 (0035)	Inversion Prevention Detection	Illuminated	Faults	320
dv7 (005B)	Polarity Judge Timeout	Illuminated	Faults	321
dWA2 (004A)	DriveWorksEZ Alarm 2	Flashing	Alarm	339
dWA3 (004B)	DriveWorksEZ Alarm 3	Flashing	Alarm	339
dWAL (0049)	DriveWorksEZ Alarm	Flashing	Alarm	339
dWF1 (004A)	EEPROM Memory DWEZ Data Error	Illuminated	Faults	321
dWF2 (004B)	DriveWorksEZ Fault 2	Illuminated	Faults	321
dWF3 (004C)	DriveWorksEZ Fault 3	Illuminated	Faults	321
dWFL (0049)	DriveWorksEZ Fault	Illuminated	Faults	321
E5 (0031)	MECHATROLINK Watchdog Timer Err	Flashing	Alarm	339
E5 (0039)	MECHATROLINK Watchdog Timer Err	Illuminated	Faults	321
EF (0007)	FWD/REV Run Command Input Error	Flashing	Alarm	340
EF0 (001A)	Option Card External Fault	Flashing	Alarm	340
EF0 (0027)	Option Card External Fault	Illuminated	Faults	321
EF1 (0042)	External Fault (Terminal S1)	Illuminated	Faults	322
EF1 (0039)	External Fault (Terminal S1)	Flashing	Alarm	340
EF2 (003A)	External Fault (Terminal S2)	Flashing	Alarm	340
EF2 (0043)	External Fault (Terminal S2)	Illuminated	Faults	322
EF3 (0009)	External Fault (Terminal S3)	Flashing	Alarm	340
EF3 (0011)	External Fault (Terminal S3)	Illuminated	Faults	322
EF4 (000A)	External Fault (Terminal S4)	Flashing	Alarm	340
EF4 (0012)	External Fault (Terminal S4)	Illuminated	Faults	322
EF5 (000B)	External Fault (Terminal S5)	Flashing	Alarm	340
EF5 (0013)	External Fault (Terminal S5)	Illuminated	Faults	322
EF6 (000C)	External Fault (Terminal S6)	Flashing	Alarm	341
EF6 (0014)	External Fault (Terminal S6)	Illuminated	Faults	322
EF7 (000D)	External Fault (Terminal S7)	Flashing	Alarm	341
EF7 (0015)	External Fault (Terminal S7)	Illuminated	Faults	323
EF8 (000E)	External Fault (Terminal S8)	Flashing	Alarm	341
EF8 (0016)	External Fault (Terminal S8)	Illuminated	Faults	323
End1	Excessive Rated Voltage Setting	Flashing	An Auto-Tuning Error	353
End2	Iron Core Saturation Coefficient	Flashing	An Auto-Tuning Error	353
End3	Rated Current Setting Alarm	Flashing	An Auto-Tuning Error	353
End4	Adjusted Slip Calculation Error	Flashing	An Auto-Tuning Error	353
End5	Resistance Tuning Error	Flashing	An Auto-Tuning Error	353
End6	Leakage Inductance Alarm	Flashing	An Auto-Tuning Error	353
End7	No-Load Current Alarm	Flashing	An Auto-Tuning Error	353
End8	HFI Alarm	Flashing	An Auto-Tuning Error	354
End9	Initial Pole Detection Alarm	Flashing	An Auto-Tuning Error	354

7.3 List of Fault, Minor Fault, Alarm, and Error Codes

Display (Hex.)	Name	ALM LED	Type	Ref.
EP24v (0081)	External Power 24V Supply	Flashing	An alarm	341
Er-01	Motor Data Error	Flashing	An Auto-Tuning Error	354
Er-02	Drive in an Alarm State	Flashing	An Auto-Tuning Error	354
Er-03	STOP Button was Pressed	Flashing	An Auto-Tuning Error	354
Er-04	Line-to-Line Resistance Error	Flashing	An Auto-Tuning Error	354
Er-05	No-Load Current Error	Flashing	An Auto-Tuning Error	355
Er-08	Rated Slip Error	Flashing	An Auto-Tuning Error	355
Er-09	Acceleration Error	Flashing	An Auto-Tuning Error	355
Er-10	Motor Direction Error	Flashing	An Auto-Tuning Error	355
Er-11	Motor Speed Error	Flashing	An Auto-Tuning Error	355
Er-12	Current Detection Error	Flashing	An Auto-Tuning Error	355
Er-13	Leakage Inductance Error	Flashing	An Auto-Tuning Error	356
Er-14	Motor Speed Error 2	Flashing	An Auto-Tuning Error	356
Er-15	Torque Saturation Error	Flashing	An Auto-Tuning Error	356
Er-16	Inertia ID Error	Flashing	An Auto-Tuning Error	356
Er-17	Reverse Prohibited Error	Flashing	An Auto-Tuning Error	356
Er-18	Back EMF Error	Flashing	An Auto-Tuning Error	356
Er-19	PM Inductance Error	Flashing	An Auto-Tuning Error	356
Er-20	Stator Resistance Error	Flashing	An Auto-Tuning Error	356
Er-21	Z Pulse Correction Error	Flashing	An Auto-Tuning Error	356
Er-25	HighFreq Inject Param Tuning Err	Flashing	An Auto-Tuning Error	357
Err (001F)	EEPROM Write Error	Illuminated	Faults	323
FAn1 (0413)	Drive Cooling Fan Fault	Illuminated	Faults	323
FbH (0028)	Excessive PID Feedback	Flashing	Alarm	341
FbH (0041)	Excessive PID Feedback	Illuminated	Faults	323
FbL (0027)	PID Feedback Loss	Flashing	Alarm	341
FbL (0028)	PID Feedback Loss	Illuminated	Faults	323
GF (0006)	Ground Fault	Illuminated	Faults	324
HCA (0034)	High Current Alarm	Flashing	Alarm	342
HLCE	High Level Communication Errors	Illuminated	Faults	324
iFEr	Communication Err	-	Backup Function Runtime Errors	358
L24v (0021)	Loss of External Power 24 Supply	Flashing	An alarm	342
LF (001C)	Output Phase Loss	Illuminated	Faults	324
LF2 (0036)	Output Current Imbalance	Illuminated	Faults	324
LoG	Log Com Error	Flashing	An alarm	342
LSo (0051)	Low Speed Motor Step-Out	Illuminated	Faults	325
LT-1 (0035)	Cooling Fan Maintenance Time	Flashing	An alarm	342
LT-2 (0036)	Capacitor Maintenance Time	Flashing	An alarm	342
LT-3 (0043)	SoftChargeBypassRelay MainteTime	Flashing	An alarm	342
LT-4 (0044)	IGBT Maintenance Time (50%)	Flashing	An alarm	342
ndAT	Model,VolClass,Capacity Mismatch	-	Backup Function Runtime Errors	358
nSE (0052)	Node Setup Error	Illuminated	Faults	325
oC (0007)	Overcurrent	Illuminated	Faults	325

7.3 List of Fault, Minor Fault, Alarm, and Error Codes

Display (Hex.)	Name	ALM LED	Type	Ref.
oFA00 (0101)	Option Not Compatible with Port	Illuminated	Faults	326
oFA01 (0102)	Option Fault/Connection Error	Illuminated	Faults	326
oFA02 (0103)	Duplicate Options	Illuminated	Faults	326
oFA03 - oFA06 (0104 - 0107)	Option Card Error Occurred at Option Port CN5-A	Illuminated	Faults	326
oFA10, oFA11 (0111, 0112)	Option Card Error Occurred at Option Port CN5-A	Illuminated	Faults	327
oFA12 - oFA17 (0113 - 0118)	Option Card Connection Error (CN5-A)	Illuminated	Faults	327
oFA30 - oFA43 (0131 - 013E)	Communication Option Card Connection Error (CN5-A)	Illuminated	Faults	327
oFb00 (0201)	Option Not Compatible with Port	Illuminated	Faults	327
oFb01 (0202)	Option Fault/Connection Error	Illuminated	Faults	327
oFb02 (0203)	Duplicate Options	Illuminated	Faults	327
oFb03 - oFb11 (0204 - 0212)	Option Card Error Occurred at Option Port CN5-B	Illuminated	Faults	327
oFb12 - oFb17 (0213 - 0218)	Option Card Connection Error (CN5-B)	Illuminated	Faults	327
oFC00 (0301)	Option Not Compatible with Port	Illuminated	Faults	328
oFC01 (0302)	Option Fault/Connection Error	Illuminated	Faults	328
oFC02 (0303)	Duplicate Options	Illuminated	Faults	328
oFC03 - oFC11 (0304 - 0312)	Option Card Error Occurred at Option Port CN5-C	Illuminated	Faults	328
oFC12 - oFC17 (0313 - 0318)	Option Card Connection Error (CN5-C)	Illuminated	Faults	328
oFC50 - oFC55 (0351 - 0356)	Option Card Error Occurred at Option Port CN5-C	Illuminated	Faults	328
oH (0003)	Heatsink Overheat	Flashing	Alarm	343
oH (0009)	Heatsink Overheat	Illuminated	Faults	328
oH1 (000A)	Heatsink Overheat	Illuminated	Faults	329
oH2 (0004)	External Overheat (H1-XX=B)	Flashing	Alarm	343
oH3 (001D)	Motor Overheat (PTC Input)	Illuminated	Faults	329
oH3 (0022)	Motor Overheat (PTC Input)	Flashing	Alarm	343
oH4 (0020)	Motor Overheat Fault (PTC Input)	Illuminated	Faults	329
oL1 (000B)	Motor Overload	Illuminated	Faults	329
oL2 (000C)	Drive Overload	Illuminated	Faults	330
oL3 (0005)	Overtorque 1	Flashing	Alarm	343
oL3 (000D)	Overtorque Detection 1	Illuminated	Faults	331
oL4 (0006)	Overtorque 2	Flashing	Alarm	344
oL4 (000E)	Overtorque Detection 2	Illuminated	Faults	331
oL5 (003D)	Mechanical Weakening Detection 1	Flashing	Alarm	344
oL5 (0044)	Mechanical Weakening Detection 1	Illuminated	Faults	331
oL7 (002B)	High Slip Braking Overload	Illuminated	Faults	331
oPE01	Drive Capacity Setting Fault	Flashing	Parameter Setting Errors	347
oPE02	Parameter Range Setting Error	Flashing	Parameter Setting Errors	347
oPE03	Multi-Function Input Setting Err	Flashing	Parameter Setting Errors	347
oPE05	Run Cmd/Freq Ref Source Sel Err	Flashing	Parameter Setting Errors	348
oPE06	Control Method Selection Error	Flashing	Parameter Setting Errors	349
oPE07	Analog Input Selection Error	Flashing	Parameter Setting Errors	349
oPE08	Parameter Selection Error	Flashing	Parameter Setting Errors	349
oPE09	PID Control Selection Fault	Flashing	Parameter Setting Errors	350
oPE10	V/f Data Setting Error	Flashing	Parameter Setting Errors	350

7.3 List of Fault, Minor Fault, Alarm, and Error Codes

Display (Hex.)	Name	ALM LED	Type	Ref.
oPE11	Carrier Frequency Setting Error	Flashing	Parameter Setting Errors	350
oPE13	Pulse Monitor Selection Error	Flashing	Parameter Setting Errors	351
oPE15	Torque Control Setting Error	Flashing	Parameter Setting Errors	351
oPE16	Energy Saving Constants Error	Flashing	Parameter Setting Errors	351
oPE18	Online Tuning Param Setting Err	Flashing	Parameter Setting Errors	351
oPE20	PG-F3 Setting Error	Flashing	Parameter Setting Errors	351
oPE33	Digital Output Selection Error	Flashing	Parameter Setting Errors	352
oPr (001E)	Keypad Connection Fault	Illuminated	Faults	332
oS (0010)	Overspeed	Flashing	Alarm	344
oS (0018)	Overspeed	Illuminated	Faults	332
ov (0002)	DC Bus Overvoltage	Flashing	Alarm	344
ov (0008)	Overvoltage	Illuminated	Faults	332
PASS	Modbus Communication Test	Flashing	Not an alarm.	344
PE1 (0047) PE2 (0048)	PLC Faults	Illuminated	Faults	333
PF (0047)	Input Phase Loss	Flashing	Alarm	344
PF (001B)	Input Phase Loss	Illuminated	Faults	333
PGo (0012)	Encoder (PG) Feedback Loss	Flashing	Alarm	345
PGo (001A)	Encoder (PG) Feedback Loss	Illuminated	Faults	333
PGoH (002B)	Encoder (PG) Hardware Fault	Flashing	Alarm	345
PGoH (0038)	Encoder (PG) Hardware Fault	Illuminated	Faults	334
PWEr	DWEZ Password Mismatch	-	Backup Function Runtime Errors	358
rdEr	Error Reading Data	-	Backup Function Runtime Errors	359
rF (004E)	Braking Resistor Fault	Illuminated	Faults	334
rH (0010)	Braking Resistor Overheat	Illuminated	Faults	334
rr (000F)	Dynamic Braking Transistor Fault	Illuminated	Faults	334
rUn (001B)	Motor Switch during Run	Flashing	Alarm	345
SC (0005)	Short Circuit/IGBT Failure	Illuminated	Faults	334
SCF (040F)	Safety Circuit Fault	Illuminated	Faults	335
SE (0020)	Modbus Test Mode Error	Flashing	Alarm	345
SEr (003B)	Speed Search Retries Exceeded	Illuminated	Faults	335
STo (003C)	Safe Torque OFF	-	An alarm	345
SToF (003B)	Safe Torque OFF	Flashing	Alarm	345
STPo (0037)	Motor Step-Out Detected	Illuminated	Faults	335
SvE (0026)	Zero Servo Fault	Illuminated	Faults	335
TiM (0089)	Keypad Time Not Set	Flashing	Alarm	346
TiM (0401)	Keypad Time Not Set	Illuminated	Faults	335
TrPC (0042)	IGBT Maintenance Time (90%)	Flashing	Alarm	346
UL3 (001E)	Undertorque Detection 1	Flashing	Alarm	346
UL3 (0029)	Undertorque Detection 1	Illuminated	Faults	335
UL4 (001F)	Undertorque Detection 2	Flashing	Alarm	346
UL4 (002A)	Undertorque Detection 2	Illuminated	Faults	336
UL5 (003E)	Mechanical Weakening Detection 2	Flashing	Alarm	346

7.3 List of Fault, Minor Fault, Alarm, and Error Codes

Display (Hex.)	Name	ALM LED	Type	Ref.
UL5 (0045)	Mechanical Weakening Detection 2	Illuminated	Faults	336
Uv (0001)	DC Bus Undervoltage	Flashing	Alarm	346
Uv1 (0002)	DC Bus Undervoltage	Illuminated	Faults	336
Uv2 (0003)	Control Power Undervoltage	Illuminated	Faults	336
Uv3 (0004)	Soft Charge Answerback Fault	Illuminated	Faults	336
vAEr	Voltage Class, Capacity Mismatch	-	Backup Function Runtime Errors	359
vFyE	Parameters do not Match	-	Backup Function Runtime Errors	359

7.4 Fault

This section gives information about some of the causes and possible solutions of faults. You must use the Fault Reset operation to remove the fault before you can operate the drive. Use the information in this table to remove the cause of the fault.

Code	Name	Causes	Possible Solutions
bAT	Keypad Battery Low Voltage	The keypad battery voltage is low.	Replace the keypad battery.
Note: Use o4-24 [bAT Detection Selection] to enable/disable bAT detection.			
Code	Name	Causes	Possible Solutions
bCE	Bluetooth Communication Fault	The smartphone or tablet with DriveWizard Mobile installed is too far from the keypad.	Use the smartphone or tablet 10 m (32.8 ft) or nearer to the keypad. Note: bCE can occur when the smartphone or tablet is 10 m or nearer to the keypad depending on the specifications of the smartphone or tablet.
		Radio waves from a different device are causing interference with communications between the smartphone or tablet and keypad.	Make sure that no device around the keypad uses the same radio bandwidth (2400 MHz to 2480 MHz), and prevent radio interference.
Note: <ul style="list-style-type: none"> The drive detects this error when operating the drive with a smartphone or tablet using the Bluetooth LCD keypad. Do a Fault Reset to clear the fault. Set the stopping method for this fault in o2-27 [bCE Detection Selection]. 			
Code	Name	Causes	Possible Solutions
boL	BrakingTransistor Overload Fault	The duty cycle of the braking transistor is high (the regeneration power or repetition frequency is high).	<ul style="list-style-type: none"> Install a braking unit (CDBR-series). Install a regenerative converter. Increase the deceleration time.
		You enabled the protective function for the braking transistor when you have a regenerative converter.	Set L8-55 = 0 [Internal DB TransistorProtection = Disable].
		The braking transistor in the drive is broken.	Replace the entire drive.
Note: Do a Fault Reset to clear the fault.			
Code	Name	Causes	Possible Solutions
bUS	Option Communication Error	The drive did not receive a signal from the controller.	Correct wiring errors.
		The communications cable wiring is incorrect.	
		There is a short-circuit in the communications cable or the communications cable is not connected.	<ul style="list-style-type: none"> Repair short circuits and connect cables. Replace the defective communications cable.
		Electrical interference caused a communication data error.	<ul style="list-style-type: none"> Examine the control circuit lines, main circuit lines, and ground wiring, and decrease the effects of electrical interference. Make sure that a magnetic contactor is not the source of the electrical interference, then use a Surge Protective Device if necessary. Use only the recommended cables or other shielded line. Ground the shield on the controller side or the drive input power side. Separate the communication wiring from drive power lines, and install a noise filter to the input side of the power supply for communication. Decrease the effects of electrical interference from the controller.
		The option is incorrectly installed to the drive.	Correctly install the option to the drive.
		The option is damaged.	If the fault continues and the wiring is correct, replace the option.
Note: <ul style="list-style-type: none"> The drive detects this error if the Run command or frequency reference is assigned to the option card. Do a Fault Reset to clear the fault. If the drive detects this error, the drive will operate the motor as specified by the stopping method set in F6-01 [Communication Error Selection]. 			
Code	Name	Causes	Possible Solutions
CE	Modbus Communication Error	The communications cable wiring is incorrect.	Correct wiring errors.
		There is a short circuit in the communications cable or the communications cable is not connected.	<ul style="list-style-type: none"> Repair short circuits and connect cables. Replace the defective communications cable.

7.4 Fault

Code	Name	Causes	Possible Solutions
		Electrical interference caused a communication data error.	<ul style="list-style-type: none"> Examine the control circuit lines, main circuit lines, and ground wiring, and decrease the effects of electrical interference. Make sure that a magnetic contactor is not the source of the electrical interference, then use a Surge Protective Device if necessary. Use only the recommended cables or other shielded line. Ground the shield on the controller side or the drive input power side. Separate the communication wiring from drive power lines, and install a noise filter to the input side of the power supply for communication. Decrease the effects of electrical interference from the controller.
Note: <ul style="list-style-type: none"> The drive detects this error if it does not correctly receive control data for the CE detection time set to H5-09 [CE Detection Time]. Do a Fault Reset to clear the fault. If the drive detects this error, the drive will operate the motor as specified by the stopping method set in H5-04 [Communication Error Stop Method]. 			
Code	Name	Causes	Possible Solutions
CF	Control Fault	Motor parameters are set incorrectly	Correctly set the motor parameters and do Auto-Tuning again.
		When A1-02 = 4 [Control Method Selection = Advanced Open Loop Vector], the drive takes long to ramp to stop because of these settings: <ul style="list-style-type: none"> The torque limit setting is too low. L3-11 = 1 [Overvoltage Suppression Select = Enabled]. d5-01 = 1 [Torque Control Selection = Torque Control]. 	When Rotational Auto-Tuning changes or the installation environment changes, make sure that you do Line-to-Line Resistance Tuning and set L8-20 = 0 [Control Fault & Step Out Detect = Disabled]. <p>Note: After you set L8-20 = 0, do test runs and examine the drive to make sure that it starts and stops correctly.</p>
		The torque limit setting is too low.	Adjust L7-01 to L7-04 [Torque Limit].
		The load inertia is too large.	<ul style="list-style-type: none"> Adjust C1-02, C1-04, C1-06, and C1-08 [Deceleration Times]. Set the frequency reference to the minimum output frequency, and stop the Run command when the drive stops deceleration.
		The drive is trying to ramp to stop a machine that cannot do ramp to stop or on a machine for which deceleration is not necessary.	Correctly set b1-03 [Stopping Method Selection].
		The motor and drive are connected incorrectly.	Correct wiring errors.
		Line-to-line Resistance Tuning is not done.	Do Stationary Auto-Tuning for Line-to-Line Resistance.
		The drive received a Run command while the motor was coasting.	<ul style="list-style-type: none"> Examine the sequence and input the Run command after the motor fully stops. Set b3-01 = 1 [Speed Search at Start Selection = Enabled].
Note: <ul style="list-style-type: none"> The drive detects this error if the torque reference is more than the torque limit for 3 seconds or longer while the drive ramps to stop. Do a Fault Reset to clear the fault. 			
Code	Name	Causes	Possible Solutions
CoF	Current Offset Fault	The drive starts operation while the induced voltage stays in the motor (during coasting to a stop or after fast deceleration).	<ul style="list-style-type: none"> Make a sequence that does not restart operation when induced voltage stays in the motor. Set b3-01 = 1 [Speed Search at Start Selection = Enabled]. Use Speed Search from Fmax or Fref [H1-xx = 61, 62] to do a speed search through one of the external terminals. <p>Note: When controlling the PM motor, External Speed Search commands 1 and 2 operate the same.</p>
		A drive hardware problem occurred.	Replace the drive.
Note: <ul style="list-style-type: none"> The drive detects this error if the current offset value is more than the permitted setting range while the drive automatically adjusts the current offset. Do a Fault Reset to clear the fault. 			
Code	Name	Causes	Possible Solutions
CP1	Comparator 1 Limit Fault	The monitor value set in H2-20 [Comparator 1 Monitor Selection] was in the range of H2-21 [Comparator 1 Lower Limit] and H2-22 [Comparator 1 Upper Limit].	Examine the monitor value and remove the cause of the fault.
Note: <ul style="list-style-type: none"> The drive detects this error when the terminal is set to H2-01 to H2-03 = 66 [MFDO Function Selection = Comparator1]. Do a Fault Reset to clear the fault. Set the stopping method for this fault in H2-33 [Comparator1 Protection Selection]. 			

Code	Name	Causes	Possible Solutions
CP2	Comparator 2 Limit Fault	The monitor value set in H2-26 [Comparator 2 Monitor Selection] was outside the range of H2-27 [Comparator 2 Lower Limit] and H2-28 [Comparator 2 Upper Limit].	Examine the monitor value and remove the cause of the fault.
Note: <ul style="list-style-type: none"> The drive detects this error when the terminal is set to H2-01 to H2-03 = 67 [MFDO Function Selection = Comparator2]. Do a Fault Reset to clear the fault. Set the stopping method for this fault in H2-35 [Comparator2 Protection Selection]. 			
Code	Name	Causes	Possible Solutions
CPF00 to CPF03, CPF07 to CPF08, CPF11 to CPF14, CPF16 to CPF24, and CPF26 to CPF39	Control Circuit Error	A drive hardware problem occurred.	<ul style="list-style-type: none"> Re-energize the drive. If the fault stays, replace the control board or the drive. For information about replacing the control board, contact Yaskawa or your nearest sales representative.
Note: <ul style="list-style-type: none"> Do a Fault Reset to clear the fault. Fault trace is not available for these faults. 			
Code	Name	Causes	Possible Solutions
CPF06	EEPROM Memory Data Error	The drive power supply was de-energized while a communication option card entered a parameter Write command.	Set A1-03 = 2220, 3330 [Initialize Parameters = 2-Wire Initialization, 3-Wire Initialization] and initialize the drive.
		An EEPROM peripheral circuit error occurred.	<ul style="list-style-type: none"> Re-energize the drive. If the fault stays, replace the control board or the drive. For information about replacing the control board, contact Yaskawa or your nearest sales representative.
Note: <ul style="list-style-type: none"> The drive detects this error if there is an error in the data written to the EEPROM of the drive. Do a Fault Reset to clear the fault. Fault trace is not available for this fault. 			
Code	Name	Causes	Possible Solutions
CPF25	Terminal Board not Connected	The terminal board is not correctly connected to the drive.	<ol style="list-style-type: none"> De-energize the drive. Correctly connect the terminal board to the drive. Re-energize the drive.
Note: <ul style="list-style-type: none"> Do a Fault Reset to clear the fault. 			
Code	Name	Causes	Possible Solutions
dEv	Speed Deviation	The load is too heavy.	Decrease the load.
		Acceleration and deceleration times are set too short.	Increase the values set in C1-01 to C1-08 [Acceleration/Deceleration Time].
		The dEv detection level settings are incorrect.	Adjust F1-10 [Speed Deviation Detection Level] and F1-11 [Speed Deviation Detect DelayTime].
		The load is locked up.	Examine the machine.
		The holding brake is stopping the motor.	Release the holding brake.
Note: <ul style="list-style-type: none"> The drive detects this error if the difference between the detected speed and the speed reference is more than the setting of F1-10 for longer than F1-11. Do a Fault Reset to clear the fault. If the drive detects this error, the drive will operate the motor as specified by the stopping method set in F1-04 [Speed Deviation Detection Select]. 			
Code	Name	Causes	Possible Solutions
dv1	Z Pulse Fault	The encoder option card or the encoder on the motor side is damaged.	<ol style="list-style-type: none"> Repair wiring errors and connect disconnected wires. Correctly ground the shielded wire of the encoder cable. Re-energize the drive If the fault stays, replace the control board or the drive. For information about replacing the control board, contact Yaskawa or your nearest sales representative.
		The encoder cable is disconnected or wired incorrectly.	
Note: <ul style="list-style-type: none"> The drive detects this error if it does not detect a Z pulse during one motor rotation. Do a Fault Reset to clear the fault. 			

7.4 Fault

Code	Name	Causes	Possible Solutions
dv2	Z Pulse Noise Fault Detection	Noise interference along the encoder cable.	Isolate the encoder cable from the drive output line or a different source of electrical interference.
		The encoder cable is disconnected or wired incorrectly.	Examine for wiring errors or disconnected wires in the encoder cable, and repair problems. Correctly ground the shielded wire of the encoder cable.
		The drive is operating a motor with 24 or more poles at zero speed.	<ul style="list-style-type: none"> Set $F1-46 = 1$ [<i>dv2 Detection Method Selection = MechanicalAngle Detection Method</i>]. Increase $F1-17$ [<i>Deviation 2 Detection Selection</i>]. Increase $F1-47$ [<i>Deviation 2 Detection Level</i>]. Note: If you change the setting of $F1-47$, the sensitivity of detection for $dv2$ can decrease.
		The PG option or the encoder on the motor side is damaged.	Repair the wiring and re-energize the drive, then replace the PG option or the encoder if the problem continues.
Note: <ul style="list-style-type: none"> The drive detects this error if it detects more than one Z pulse per rotation for the number of rotations set in $F1-17$ [<i>Deviation 2 Detection Selection</i>]. Do a Fault Reset to clear the fault. 			
Code	Name	Causes	Possible Solutions
dv3	Inversion Detection	$E5-11$ [<i>Encoder Z-Pulse Offset</i>] is set incorrectly.	Correctly set the value for $\Delta\theta$ to $E5-11$ as specified by the values on the motor nameplate.
		There is a new encoder or the motor rotation direction changed.	Do Z Pulse Offset Tuning.
		An external force on the load side rotated the motor.	<ul style="list-style-type: none"> Make sure that the motor is rotating in the correct direction. Find and repair problems on the load side that cause the motor to rotate from the load side.
		Noise interference along the encoder cable.	Correctly ground the shielded wire of the encoder cable.
		The encoder cable is disconnected or wired incorrectly.	Examine for wiring errors or disconnected wires in the encoder cable, and repair problems.
		The setting for $F1-05$ [<i>Encoder 1 Rotation Selection</i>] is the opposite of the direction of motor rotation.	Correctly connect the motor wiring for each phase (U, V, W).
		The drive incorrectly detected the motor magnetic pole position.	If the value for $U6-57$ [<i>PolePolarityDeterVal</i>] is lower than 819, increase the value set in $n8-84$ [<i>Polarity Detection Current</i>]. Contact the motor manufacturer to confirm the maximum setting values.
		The setting value of $n8-84$ [<i>Polarity Detection Current</i>] is too low.	Increase the value set in $n8-84$ from the default setting. Contact the motor manufacturer to confirm the maximum setting values.
		The drive did not make a correct estimate of the initial pole count.	When you use an IPM motor, do High Frequency Injection Auto-Tuning.
The PG option card or the encoder on the motor side is damaged.	Repair the wiring and re-energize the drive, then replace the PG option card or the encoder if the problem continues.		
Note: <ul style="list-style-type: none"> The drive detects this error if: <ul style="list-style-type: none"> the torque reference and acceleration are in opposite directions. the speed reference and actual motor speed are more than 30% different for the number of times set to $F1-18$ [<i>Deviation 3 Detection Selection</i>]. Do a Fault Reset to clear the fault. 			
Code	Name	Causes	Possible Solutions
dv4	Inversion Prevention Detection	An external force on the load side rotated the motor.	<ul style="list-style-type: none"> Make sure that the motor is rotating in the correct direction. Find and repair problems on the load side that cause the motor to rotate from the load side. Disable detection of this fault for applications that rotate the motor from the load side in the opposite direction of the speed reference. The drive will not detect this fault if $F1-19 = 0$ [<i>Deviation 4 Detection Selection = Disabled</i>].
		$E5-11$ [<i>Encoder Z-Pulse Offset</i>] is set incorrectly.	Correctly set the value for $\Delta\theta$ to $E5-11$ as specified by the values on the motor nameplate.
		There is a new encoder or the motor rotation direction changed.	Do Z Pulse Offset Tuning.
		Noise interference along the encoder cable.	Correctly ground the shielded wire of the encoder cable.
		The encoder cable is disconnected or wired incorrectly.	Examine for wiring errors or disconnected wires in the encoder cable, and repair problems.
		The drive incorrectly detected the motor magnetic pole position.	If the value for $U6-57$ [<i>PolePolarityDeterVal</i>] is lower than 819, increase the value set in $n8-84$ [<i>Polarity Detection Current</i>]. Consult the motor manufacturer for information about maximum setting values.

Code	Name	Causes	Possible Solutions
		The setting of <i>n8-84 [Polarity Detection Current]</i> is too low.	Increase the <i>n8-84</i> setting from the default. Consult the motor manufacturer for information about maximum setting values.
		Pole Position Detection failed.	If you are using an IPM motor, do High Frequency Injection Auto-Tuning.
		The PG option card or the encoder on the motor side is damaged.	Repair the wiring and re-energize the drive, then replace the PG option card or the PG if the problem continues.
Note: <ul style="list-style-type: none"> The drive detects this error if the pulses in the opposite direction of the speed reference are more than the value set in <i>F1-19</i>. Do a Fault Reset to clear the fault. 			
Code	Name	Causes	Possible Solutions
dv7	Polarity Judge Timeout	There is a disconnection in the motor coil winding.	Measure the motor line-to-line resistance and replace the motor if a coil is disconnected.
		The screws on the drive output terminals are loose.	Tighten the terminal screws to the correct tightening torque.
Note: <ul style="list-style-type: none"> The drive detects this error if it cannot detect polarity in a pre-set length of time. Do a Fault Reset to clear the fault. 			
Code	Name	Causes	Possible Solutions
dWF1	EEPROM Memory DWEZ Data Error	There is an error in the EEPROM peripheral circuit.	<ul style="list-style-type: none"> Re-energize the drive. If the fault stays, replace the control board or the drive. For information about replacing the control board, contact Yaskawa or your nearest sales representative.
		There is a problem with the EEPROM data.	Set <i>A1-03 = 2220, 3330 [Initialize Parameters = 2-Wire Initialization, 3-Wire Initialization]</i> to initialize the drive, then upload the DriveWorksEZ project to the drive again.
Note: <ul style="list-style-type: none"> The drive detects this error if there is an error in the DriveWorksEZ program that was saved to EEPROM. Do a Fault Reset to clear the fault. 			
Code	Name	Causes	Possible Solutions
dWF2	DriveWorksEZ Fault 2	There was a fault in the DriveWorksEZ program.	Examine the DriveWorksEZ program and remove the cause of the fault. This is not a drive fault.
Note: Do a Fault Reset to clear the fault.			
Code	Name	Causes	Possible Solutions
dWF3	DriveWorksEZ Fault 3	There was a fault in the DriveWorksEZ program.	Examine the DriveWorksEZ program and remove the cause of the fault. This is not a drive fault.
Note: Do a Fault Reset to clear the fault.			
Code	Name	Causes	Possible Solutions
dWFL	DriveWorksEZ Fault	There was a fault in the DriveWorksEZ program.	Examine the DriveWorksEZ program and remove the cause of the fault. This is not a drive fault.
Note: Do a Fault Reset to clear the fault.			
Code	Name	Causes	Possible Solutions
E5	MECHATROLINK Watchdog Timer Err	The drive detected a watchdog circuit exception while it received data from the controller.	Examine the MECHATROLINK cable connection. If this error occurs frequently, examine the wiring and decrease the effects of electrical interference as specified by these manuals: <ul style="list-style-type: none"> MECHATROLINK-II Installation Guide (MECHATROLINK Members Association, manual number MMATDEP011) MECHATROLINK-III Installation Manual (MECHATROLINK Members Association, publication number MMATDEP018)
Note: <ul style="list-style-type: none"> Do a Fault Reset to clear the fault. If the drive detects this fault, it will operate the motor as specified by the stop method set in <i>F6-25 [MECHATROLINK Watchdog Error Sel]</i>. 			
Code	Name	Causes	Possible Solutions
EF0	Option Card External Fault	The communication option received an external fault from the controller.	<ol style="list-style-type: none"> Find the device that caused the external fault and remove the cause. Clear the external fault input from the controller.
		A programming error occurred on the controller side.	Examine the operation of the controller program.
Note: <ul style="list-style-type: none"> The drive detects this fault if the alarm function on the external device side is operating. Do a Fault Reset to clear the fault. If the drive detects this fault, it will operate the motor as specified by the stop method set in <i>F6-03 [Comm External Fault (EF0) Select]</i>. 			

7.4 Fault

Code	Name	Causes	Possible Solutions
EF1	External Fault (Terminal S1)	MFDI terminal S1 caused an external fault through an external device.	1. Find the device that caused the external fault and remove the cause. 2. Clear the external fault input in the MFDI.
		The wiring is incorrect.	Correctly connect the signal line to MFDI terminal S1.
		<i>External Fault [HI-01 = 20 to 2B]</i> is set to MFDI terminal S1, but the terminal is not in use.	Correctly set the MFDI.
Note: Do a Fault Reset to clear the fault.			
Code	Name	Causes	Possible Solutions
EF2	External Fault (Terminal S2)	MFDI terminal S2 caused an external fault through an external device.	1. Find the device that caused the external fault and remove the cause. 2. Clear the external fault input in the MFDI.
		The wiring is incorrect.	Correctly connect the signal line to MFDI terminal S2.
		<i>External Fault [HI-02 = 20 to 2B]</i> is set to MFDI terminal S2, but the terminal is not in use.	Correctly set the MFDI.
Note: Do a Fault Reset to clear the fault.			
Code	Name	Causes	Possible Solutions
EF3	External Fault (Terminal S3)	MFDI terminal S3 caused an external fault through an external device.	1. Find the device that caused the external fault and remove the cause. 2. Clear the external fault input in the MFDI.
		The wiring is incorrect.	Correctly connect the signal line to MFDI terminal S3.
		<i>External Fault [HI-03 = 20 to 2B]</i> is set to MFDI terminal S3, but the terminal is not in use.	Correctly set the MFDI.
Note: Do a Fault Reset to clear the fault.			
Code	Name	Causes	Possible Solutions
EF4	External Fault (Terminal S4)	MFDI terminal S4 caused an external fault through an external device.	1. Find the device that caused the external fault and remove the cause. 2. Clear the external fault input in the MFDI.
		The wiring is incorrect.	Correctly connect the signal line to MFDI terminal S4.
		<i>External Fault [HI-04 = 20 to 2B]</i> is set to MFDI terminal S4, but the terminal is not in use.	Correctly set the MFDI.
Note: Do a Fault Reset to clear the fault.			
Code	Name	Causes	Possible Solutions
EF5	External Fault (Terminal S5)	MFDI terminal S5 caused an external fault through an external device.	1. Find the device that caused the external fault and remove the cause. 2. Clear the external fault input in the MFDI.
		The wiring is incorrect.	Correctly connect the signal line to MFDI terminal S5.
		<i>External Fault [HI-05 = 20 to 2B]</i> is set to MFDI terminal S5, but the terminal is not in use.	Correctly set the MFDI.
Note: Do a Fault Reset to clear the fault.			
Code	Name	Causes	Possible Solutions
EF6	External Fault (Terminal S6)	MFDI terminal S6 caused an external fault through an external device.	1. Find the device that caused the external fault and remove the cause. 2. Clear the external fault input in the MFDI.
		The wiring is incorrect.	Correctly connect the signal line to MFDI terminal S6.
		<i>External Fault [HI-06 = 20 to 2B]</i> is set to MFDI terminal S6, but the terminal is not in use.	Correctly set the MFDI.
Note: Do a Fault Reset to clear the fault.			

Code	Name	Causes	Possible Solutions
EF7	External Fault (Terminal S7)	MFDI terminal S7 caused an external fault through an external device.	<ol style="list-style-type: none"> Find the device that caused the external fault and remove the cause. Clear the external fault input in the MFDI.
		The wiring is incorrect.	Correctly connect the signal line to MFDI terminal S7.
		<i>External Fault [H1-07 = 20 to 2B]</i> is set to MFDI terminal S7, but the terminal is not in use.	Correctly set the MFDI.
Note: Do a Fault Reset to clear the fault.			
Code	Name	Causes	Possible Solutions
EF8	External Fault (Terminal S8)	MFDI terminal S8 caused an external fault through an external device.	<ol style="list-style-type: none"> Find the device that caused the external fault and remove the cause. Clear the external fault input in the MFDI.
		The wiring is incorrect.	Correctly connect the signal line to MFDI terminal S8.
		<i>External Fault [H1-08 = 20 to 2B]</i> is set to MFDI terminal S8, but the terminal is not in use.	Correctly set the MFDI.
Note: Do a Fault Reset to clear the fault.			
Code	Name	Causes	Possible Solutions
Err	EEPROM Write Error	There was a problem with the EEPROM hardware.	<ul style="list-style-type: none"> Re-energize the drive. If the fault stays, replace the control board or the drive. Contact Yaskawa or your nearest sales representative to replace the board.
		Electrical interference corrupted the data while it was writing to the EEPROM of the drive.	<ul style="list-style-type: none"> Push ENTER Key. Set the parameters again.
Note: Do a Fault Reset to clear the fault.			
Code	Name	Causes	Possible Solutions
FAnI	Drive Cooling Fan Fault	The cooling fan stopped operating correctly.	<ul style="list-style-type: none"> Examine cooling fan operation. Re-energize the drive. Examine <i>U4-03 [Cooling Fan Ope Time]</i> and <i>U4-04 [Cool Fan Maintenance]</i>. If the performance life of the cooling fan is expired or if there is damage to the fan, replace the fan.
		The circulation fan is damaged.	<ul style="list-style-type: none"> Examine circulation fan operation. Re-energize the drive. Examine <i>U4-03 [Cooling Fan Ope Time]</i> and <i>U4-04 [Cool Fan Maintenance]</i>. If there is damage to the circulation fan or if the performance life of the fan is expired, replace the fan.
Note: Do a Fault Reset to clear the fault.			
Code	Name	Causes	Possible Solutions
FbH	Excessive PID Feedback	The <i>FbH</i> detection level is set incorrectly.	Adjust <i>b5-36 [PID High Feedback Detection Lvl]</i> and <i>b5-37 [PID High Feedback Detection Time]</i> .
		There is a problem with the PID feedback wiring.	Correct errors with the PID control wiring.
		The feedback sensor is not operating correctly.	Examine the sensors on the control device side.
		A fault occurred in the feedback input circuit of the drive.	Replace the control board or the drive. For information about replacing the control board, contact Yaskawa or your nearest sales representative.
Note: <ul style="list-style-type: none"> The drive detects this fault if the PID feedback input is more than the level set in <i>b5-36</i> for longer than <i>b5-37</i>. Do a Fault Reset to clear the fault. If the drive detects this fault, it will operate the motor as specified by the stop method set in <i>b5-12 [Feedback Loss Detection Select]</i>. 			
Code	Name	Causes	Possible Solutions
FbL	PID Feedback Loss	The <i>FbL</i> detection level is set incorrectly.	Adjust <i>b5-13 [PID Feedback Loss Detection Lvl]</i> and <i>b5-14 [PID Feedback Loss Detection Time]</i> .
		There is a problem with the PID feedback wiring.	Correct errors with the PID control wiring.
		The feedback sensor is not operating correctly.	Examine the sensors on the control device side.

7.4 Fault

Code	Name	Causes	Possible Solutions
		A fault occurred in the feedback input circuit of the drive.	Replace the control board or the drive. For information about replacing the control board, contact Yaskawa or your nearest sales representative.
Note: <ul style="list-style-type: none"> The drive detects this fault if the PID feedback input is more than the level set in <i>b5-13</i> for longer than <i>b5-14</i>. Do a Fault Reset to clear the fault. If the drive detects this fault, it will operate the motor as specified by the stop method set in <i>b5-12</i> [<i>Feedback Loss Detection Select</i>]. 			
Code	Name	Causes	Possible Solutions
GF	Ground Fault	Overheating caused damage to the motor or the motor insulation is not satisfactory.	Measure the motor insulation resistance, and replace the motor if there is electrical conduction or unserviceable insulation.
		The motor main circuit cable is contacting ground to make a short circuit.	<ul style="list-style-type: none"> Examine the motor main circuit cable for damage, and repair short circuits. Measure the resistance between the motor main circuit cable and the ground terminal. If there is electrical conduction, replace the cable.
		An increase in the stray capacitance of the cable and the ground terminal caused an increase in the leakage current.	<ul style="list-style-type: none"> If the wiring length of the cable is more than 100 m, decrease the carrier frequency. Decrease the stray capacitance.
		There was a problem with the drive hardware.	Replace the control board or the drive. For information about replacing the control board, contact Yaskawa or your nearest sales representative.
Note: <ul style="list-style-type: none"> The drive detects this fault if a current short to ground was more than 50% of rated current on the output side of the drive. Do a Fault Reset to clear the fault. <i>L5-08</i> [<i>Fault Reset Enable Select Grp2</i>] disables the Auto Restart function. 			
Code	Name	Causes	Possible Solutions
HLCE	High Level Communication Errors	Communication data error occurred between the option and the master drive when you use Gateway function. The master drive detects <i>oFxxx</i> and the slave drive detects <i>HLCE</i> .	Examine the wiring between the option and the master drive and remove the cause of the fault.
Note: This fault occurs when the drive is a slave drive in Gateway Mode [<i>F6-16</i> ≠ 0] and communication is lost from the master.			
Code	Name	Causes	Possible Solutions
LF	Output Phase Loss	The motor main circuit cable is disconnected.	Connect motor main circuit cable wiring. Correct wiring errors in the main circuit drive input power.
		There is a disconnection in the motor coil winding.	If a coil is disconnected, measure the motor Line-to-Line Resistance and replace the motor.
		The screws on the drive output terminals are loose.	Tighten the terminal screws to the correct tightening torque.
		The rated output current of the motor is less than 5% of the drive rated current.	Examine the drive capacity or the motor output to be applied.
		You are trying to use a single-phase motor.	The drive cannot operate a single-phase motor.
		The output transistor in the drive is damaged.	<ul style="list-style-type: none"> Re-energize the drive. If the fault stays, replace the control board or the drive. For information about replacing the control board, contact Yaskawa or your nearest sales representative.
Note: <ul style="list-style-type: none"> The drive detects this fault if phase loss occurs on the output side of the drive. Do a Fault Reset to clear the fault. Set <i>L8-07</i> [<i>Output Phase Loss Protection Sel</i>] to enable and disable <i>LF</i> detection. 			
Code	Name	Causes	Possible Solutions
LF2	Output Current Imbalance	Phase loss occurred in the wiring on the output side of the drive.	Examine for wiring errors or disconnected wires on the output side of the drive, and repair problems.
		The output terminal screws of the drive are loose.	Tighten the terminal screws to the correct tightening torque.
		There is not balance between the three phases of the PM motor impedance.	<ul style="list-style-type: none"> Measure the Line-to-Line Resistance for each motor phase and make sure that resistance is equal in the three phases, and that all wires are connected correctly. Replace the motor.
		The drive output circuit is broken.	<ul style="list-style-type: none"> Re-energize the drive. If the fault stays, replace the control board or the drive. For information about replacing the control board, contact Yaskawa or your nearest sales representative.
Note: <ul style="list-style-type: none"> The drive detects this fault if there is not balance between the three phases of the output current from the PM motor. Do a Fault Reset to clear the fault. 			

Code	Name	Causes	Possible Solutions
LSo	Low Speed Motor Step-Out	The motor code set incorrectly.	<ul style="list-style-type: none"> Set E5-01 [PM Motor Code Selection] correctly as specified by the motor. For specialized motors, refer to the motor test report and set E5-xx correctly.
		The load is too large.	<ul style="list-style-type: none"> Decrease the load. Replace the drive and motor with larger capacity models.
		An external force on the load side caused the motor to move at start.	Find and repair problems on the load side that cause the motor to rotate from the load side.
		The drive incorrectly detected the motor magnetic pole position.	<ul style="list-style-type: none"> Set b3-01 = 1 [Speed Search at Start Selection = Enabled]. If the value for U6-57 [PolePolarityDeterVal] is lower than 819, increase the value set in n8-84 [Polarity Detection Current]. Consult the motor manufacturer for information about maximum setting values.
		The setting of n8-84 [Polarity Detection Current] is too low.	Increase the n8-84 setting from the default. Consult the motor manufacturer for information about maximum setting values.
		Incorrect values set in L8-93 [Low Speed Pull-out DetectionTime], L8-94 [Low Speed Pull-out Detect Level], and L8-95 [Low Speed Pull-out Amount].	Increase the values set in L8-93 to L8-95.
		The drive incorrectly detected the motor magnetic pole position.	If you are using an IPM motor, do High Frequency Injection Auto-Tuning.
Note: <ul style="list-style-type: none"> The drive detects this fault if it detects step-out while running at low speed. Do a Fault Reset to clear the fault. LSo is a protective function that stops the motor and stops the reverse run if a motor without a motor code incorrectly detects the initial polarity. To quickly detect motor reversal, decrease the values set in L8-93 to L8-95 to a range in which the drive does not malfunction. 			
Code	Name	Causes	Possible Solutions
nSE	Node Setup Error	The H1-xx = 47 [Node Setup (CANopen)] terminal was activated during run.	Stop the drive when the Node Setup function is in use.
		The drive received a Run command while the Node Setup function was active.	
Note: Do a Fault Reset to clear the fault.			
Code	Name	Causes	Possible Solutions
oC	Overcurrent	The load is too heavy.	<ul style="list-style-type: none"> Measure the current flowing into the motor. Replace the drive with a larger capacity model if the current value is more than the drive rated current. Decrease the load or replace with a larger drive to prevent sudden changes in the current level.
		Overheating caused damage to the motor or the motor insulation is not satisfactory.	Measure the motor insulation resistance, and replace the motor if there is electrical conduction or unserviceable insulation.
		The motor main circuit cable is contacting ground to make a short circuit.	<ul style="list-style-type: none"> Examine the motor main circuit cable for damage, and repair short circuits. Measure the resistance between the motor main circuit cable and the ground terminal. If there is electrical conduction, replace the cable.
		A short circuit or ground fault on the drive output side caused damage to the output transistor of the drive.	<ul style="list-style-type: none"> Make sure that there is not a short circuit in terminal B1 and terminals U/T1, V/T2, and W/T3. Make sure that there is not a short circuit in terminals - and terminals U/T1, V/T2, and W/T3. If there is a short circuit, contact Yaskawa or your nearest sales representative.
		The acceleration time is too short.	<ul style="list-style-type: none"> Calculate the torque necessary during acceleration related to the load inertia and the specified acceleration time. Increase the values set in C1-01, C1-03, C1-05, or C1-07 [Acceleration Times] to get the necessary torque. Increase the values set in C2-01 to C2-04 [S-Curve Characteristics] to get the necessary torque. Replace the drive with a larger capacity model.
		The drive is trying to operate a specialized motor or a motor that is larger than the maximum applicable motor output of the drive.	<ul style="list-style-type: none"> Examine the motor nameplate, the motor, and the drive to make sure that the drive rated current is larger than the motor rated current. Replace the drive with a larger capacity model.
		A magnetic contactor was switched at the output.	Set the operation sequence to not turn ON or OFF the magnetic contactor while the drive is outputting voltage.
		The V/f pattern settings are incorrect.	<ul style="list-style-type: none"> Examine the ratios between the V/f pattern frequency and voltage. Decrease the voltage if it is too high compared to the frequency. Adjust E1-04 to E1-10 [V/f Pattern Parameters]. For motor 2, adjust E3-04 to E3-10.

7.4 Fault

Code	Name	Causes	Possible Solutions
		The torque compensation gain is too large.	Decrease the value set in <i>C4-01 [Torque Compensation Gain]</i> to make sure that the motor does not stall.
		Electrical interference caused a problem.	Examine the control circuit lines, main circuit lines, and ground wiring, and decrease the effects of electrical interference.
		The gain during overexcitation operation is too large.	<ul style="list-style-type: none"> Find the time when the fault occurs. If the fault occurs at the same time as overexcitation operation, decrease the value set in <i>n3-13 [OverexcitationBraking (OEB) Gain]</i> and consider the motor flux saturation.
		The drive received a Run command while the motor was coasting.	<ul style="list-style-type: none"> Examine the sequence and input the Run command after the motor fully stops. Set <i>b3-01 = 1 [Speed Search at Start Selection = Enabled]</i> or set <i>H1-xx = 61, 62 [Speed Search from Fmax or Fref]</i> to input speed search commands from the MFDI terminals.
		In PM Control Methods, the setting of the motor code is incorrect.	<ul style="list-style-type: none"> Enter the correct motor code to <i>E5-01 [PM Motor Code Selection]</i> as specified by the PM motor. For specialized motors, refer to the motor test report and set <i>E5-xx [PM Motor Settings]</i> correctly.
		If the drive detects the fault at start or in the low speed range (10% or less) and <i>n8-57 = 1 [HFI Overlap Selection = Enabled]</i> for PM Control methods, the high frequency injection gain is too high.	<ul style="list-style-type: none"> Set <i>E5-xx [PM Motor Parameters]</i> correctly or do Rotational Auto-Tuning. Decrease the value of <i>n8-41 [HFI P Gain]</i> in 0.5 unit increments. Note: Set <i>n8-41 > 0.0</i> for an ordinary IPM motor.
		The current flowing in the motor is more than the value set in <i>L8-27 [Overcurrent Detection Gain]</i> for PM Control Methods.	Correct the value set in <i>L8-27</i> .
		The control method is set incorrectly for the motor.	Set <i>A1-02 [Control Method Selection]</i> correctly.
		The motor main circuit cable is too long.	Replace the drive with a larger capacity model.
		Speed search does not complete at start when you set <i>A1-02 = 8 [EZ Vector Control]</i> and use an induction motor.	When <i>E9-01 = 0 [Motor Type Selection = Induction (IM)]</i> , set <i>b3-24 = 2 [Speed Search Method Selection = Current Detection Speed Search]</i> .
		An overcurrent occurred during overexcitation deceleration.	<ul style="list-style-type: none"> Decrease the value set in <i>n3-13 [OverexcitationBraking (OEB) Gain]</i>. Decrease the value set in <i>n3-21 [HSB Current Suppression Level]</i>.
Note: <ul style="list-style-type: none"> This fault occurs if the drive sensors detect a drive output current more than the specified overcurrent detection level. Do a Fault Reset to clear the fault. 			
Code	Name	Causes	Possible Solutions
oFA00	Option Not Compatible with Port	The option card connected to connector CN5-A is not compatible.	Connect the option card to the correct connector. Note: Encoder option cards are not compatible with connector CN5-A.
Note: <ul style="list-style-type: none"> Do a Fault Reset to clear the fault. Fault trace is not available for this fault. 			
Code	Name	Causes	Possible Solutions
oFA01	Option Fault/Connection Error	The option card connected to connector CN5-A is not compatible.	<ol style="list-style-type: none"> De-energize the drive. Refer to the option card manual and correctly connect the option card to the connector on the drive.
Note: Do a Fault Reset to clear the fault.			
Code	Name	Causes	Possible Solutions
oFA02	Duplicate Options	The same option cards or the same type of option cards are connected to connectors CN5-A, B, and C.	Connect the option card to the correct connector. Note: Use connectors CN5-C and CN5-B to connect two encoder option cards.
Note: Do a Fault Reset to clear the fault.			
Code	Name	Causes	Possible Solutions
oFA03 to oFA06	Option Card Error Occurred at Option Port CN5-A	A fault occurred in the option card.	<ol style="list-style-type: none"> De-energize the drive. Make sure that the option card is correctly connected to the connector. If the problem continues, replace the option card.
Note: Do a Fault Reset to clear the fault.			

Code	Name	Causes	Possible Solutions
oFA10, oFA11	Option Card Error Occurred at Option Port CN5-A	A fault occurred in the option card.	<ol style="list-style-type: none"> De-energize the drive. Make sure that the option card is correctly connected to the connector. If the problem continues, replace the option card.
Note: Do a Fault Reset to clear the fault.			
Code	Name	Causes	Possible Solutions
oFA12 to oFA17	Option Card Connection Error (CN5-A)	A fault occurred in the option card.	<ol style="list-style-type: none"> De-energize the drive. Make sure that the option card is correctly connected to the connector. If the problem continues, replace the option card.
Note: Do a Fault Reset to clear the fault.			
Code	Name	Causes	Possible Solutions
oFA30 to oFA43	Communication Option Card Connection Error (CN5-A)	A fault occurred in the option card.	<ol style="list-style-type: none"> De-energize the drive. Make sure that the option card is correctly connected to the connector. If the problem continues, replace the option card.
Note: Do a Fault Reset to clear the fault.			
Code	Name	Causes	Possible Solutions
oFb00	Option Not Compatible with Port	The option card connected to connector CN5-B is not compatible.	Connect the option card to the correct connector. Note: DO-A3, AO-A3, PG-B3, and PG-X3 options can connect to connector CN5-B. Use connector CN5-C when connecting only one encoder option card.
Note: <ul style="list-style-type: none"> Do a Fault Reset to clear the fault. Fault trace is not available for this fault. 			
Code	Name	Causes	Possible Solutions
oFb01	Option Fault/Connection Error	The option card connected to connector CN5-B was changed during operation.	<ol style="list-style-type: none"> De-energize the drive. Refer to the option card manual and correctly connect the option card to the connector on the drive.
Note: Do a Fault Reset to clear the fault.			
Code	Name	Causes	Possible Solutions
oFb02	Duplicate Options	The same option cards or the same type of option cards are connected to connectors CN5-A, B, and C.	Connect the option card to the correct connector.
Note: Do a Fault Reset to clear the fault.			
Code	Name	Causes	Possible Solutions
oFb03 to oFb11	Option Card Error Occurred at Option Port CN5-B	A fault occurred in the option card.	<ol style="list-style-type: none"> De-energize the drive. Make sure that the option card is correctly connected to the connector. If the problem continues, replace the option card.
Note: Do a Fault Reset to clear the fault.			
Code	Name	Causes	Possible Solutions
oFb12 to oFb17	Option Card Error Occurred at Option Port CN5-B	A fault occurred in the option card.	<ol style="list-style-type: none"> De-energize the drive. Make sure that the option card is correctly connected to the connector. If the problem continues, replace the option card.
Note: Do a Fault Reset to clear the fault.			

7.4 Fault

Code	Name	Causes	Possible Solutions
oFC00	Option Not Compatible with Port	The option card connected to connector CN5-C is not compatible.	Connect the option card to the correct connector. Note: AI-A3, DI-A3, and communication option cards cannot be connected to the CN5-C connector.
Note: • Do a Fault Reset to clear the fault. • Fault trace is not available for this fault.			
Code	Name	Causes	Possible Solutions
oFC01	Option Fault/Connection Error	The option card connected to connector CN5-C was changed during operation.	<ol style="list-style-type: none"> 1. De-energize the drive. 2. Refer to the option card manual and correctly connect the option card to the connector on the drive.
Note: Do a Fault Reset to clear the fault.			
Code	Name	Causes	Possible Solutions
oFC02	Duplicate Options	The same option cards or the same type of option cards are connected to connectors CN5-A, B, and C.	Connect the option card to the correct connector.
Note: Do a Fault Reset to clear the fault.			
Code	Name	Causes	Possible Solutions
oFC03 to oFC11	Option Card Error Occurred at Option Port CN5-C	A fault occurred in the option card.	<ol style="list-style-type: none"> 1. De-energize the drive. 2. Make sure that the option card is correctly connected to the connector. 3. If the problem continues, replace the option card.
Note: Do a Fault Reset to clear the fault.			
Code	Name	Causes	Possible Solutions
oFC12 to oFC17	Option Card Error Occurred at Option Port CN5-C	A fault occurred in the option card.	<ol style="list-style-type: none"> 1. De-energize the drive. 2. Make sure that the option card is correctly connected to the connector. 3. If the problem continues, replace the option card.
Note: Do a Fault Reset to clear the fault.			
Code	Name	Causes	Possible Solutions
oFC50 to oFC55	Option Card Error Occurred at Option Port CN5-C	A fault occurred in the option card.	Refer to the manual for the PG-RT3 or PG-F3 option card.
Note: Do a Fault Reset to clear the fault.			
Code	Name	Causes	Possible Solutions
oH	Heatsink Overheat	The ambient temperature is high and the heatsink temperature of the drive is more than the value set in L8-02 [Overheat Alarm Level].	<ul style="list-style-type: none"> • Measure the ambient temperature. • Increase the airflow in the control panel. • Install a cooling device (cooling fan or air conditioner) to lower the ambient temperature. • Remove objects near the drive that are producing too much heat.
		The load is too heavy.	<ul style="list-style-type: none"> • Measure the output current. • Decrease the load. • Decrease the value set in C6-02 [Carrier Frequency Selection].
		The internal cooling fan of the drive stopped.	<ol style="list-style-type: none"> 1. Use the procedures in this manual to replace the cooling fan. 2. Set o4-03 = 0 [Fan Operation Time Setting = 0 h].
Note: • The drive detects this fault if the heatsink temperature of the drive is more than the value set in L8-02. • Do a Fault Reset to clear the fault. • If the drive detects this fault, it will operate the motor as specified by the Stopping Method set in L8-03 [Overheat Pre-Alarm Selection].			

Code	Name	Causes	Possible Solutions
oH1	Heatsink Overheat	The ambient temperature is high and the heatsink temperature of the drive is more than the <i>oH1</i> detection level.	<ul style="list-style-type: none"> Measure the ambient temperature. Increase the airflow in the control panel. Install a cooling device (cooling fan or air conditioner) to lower the ambient temperature. Remove objects near the drive that are producing too much heat.
		The load is too heavy.	<ul style="list-style-type: none"> Measure the output current. Decrease the load. Decrease the value set in <i>C6-02</i> [<i>Carrier Frequency Selection</i>].
Note: <ul style="list-style-type: none"> The drive detects this fault if the heatsink temperature of the drive is more than the <i>oH1</i> detection level. <i>o2-04</i> [<i>Drive Model (KVA) Selection</i>] determines the <i>oH1</i> detection level. Do a Fault Reset to clear the fault. <i>L5-08</i> [<i>Fault Reset Enable Select Grp2</i>] disables the Auto Restart function. 			
Code	Name	Causes	Possible Solutions
oH3	Motor Overheat (PTC Input)	The thermistor wiring that detects motor temperature is defective.	Correct wiring errors.
		A fault occurred on the machine. Example: The machine is locked.	Examine the machine and remove the cause of the fault
		The motor has overheated.	<ul style="list-style-type: none"> Check the load level, acceleration/deceleration time, and motor start/stop frequency (cycle time). Decrease the load. Increase the values set in <i>C1-01</i> to <i>C1-08</i> [<i>Acceleration/Deceleration Times</i>]. Set <i>E2-01</i> [<i>Motor Rated Current (FLA)</i>] correctly to the value specified by the motor nameplate. Make sure that the motor cooling system is operating correctly, and repair or replace it if it is damaged. Adjust <i>E1-04</i> to <i>E1-10</i> [<i>V/f Pattern Parameters</i>]. For motor 2, adjust <i>E3-04</i> to <i>E3-10</i>. Decrease the values set in <i>E1-08</i> [<i>Mid Point A Voltage</i>] and <i>E1-10</i> [<i>Minimum Output Voltage</i>]. Note: If the values set in <i>E1-08</i> and <i>E1-10</i> are too low, the overload tolerance will decrease at low speeds.
Note: <ul style="list-style-type: none"> When <i>H3-02</i>, <i>H3-10</i>, or <i>H3-06 = E</i> [<i>MFAI Function Select = Motor Temperature (PTC Input)</i>], the drive detects this fault if the motor overheat signal entered to analog input terminals A1 to A3 is more than the alarm detection level. Do a Fault Reset to clear the fault. If the drive detects this fault, it will operate the motor as specified by the Stopping Method set in <i>L1-03</i> [<i>Motor Thermistor oH Alarm Select</i>]. 			
Code	Name	Causes	Possible Solutions
oH4	Motor Overheat Fault (PTC Input)	The motor has overheated.	<ul style="list-style-type: none"> Check the load level, acceleration/deceleration time, and motor start/stop frequency (cycle time). Decrease the load. Increase the values set in <i>C1-01</i> to <i>C1-08</i> [<i>Acceleration/Deceleration Times</i>]. Set <i>E2-01</i> [<i>Motor Rated Current (FLA)</i>] correctly to the value specified by the motor nameplate. Make sure that the motor cooling system is operating correctly, and repair or replace it if it is damaged. Adjust <i>E1-04</i> to <i>E1-10</i> [<i>V/f Pattern Parameters</i>]. For motor 2, adjust <i>E3-04</i> to <i>E3-10</i>. Decrease the values set in <i>E1-08</i> [<i>Mid Point A Voltage</i>] and <i>E1-10</i> [<i>Minimum Output Voltage</i>]. Note: If <i>E1-08</i> and <i>E1-10</i> are set too low, the overload tolerance will decrease at low speeds.
Note: <ul style="list-style-type: none"> The drive detects this fault if the motor overheat signal that was entered to an analog input terminals A1, A2, or A3 is more than the alarm detection level. (If <i>H3-02</i>, <i>H3-10</i>, or <i>H3-06 = E</i> [<i>MFAI Function Select = Motor Temperature (PTC Input)</i>] was set.) Do a Fault Reset to clear the fault. 			
Code	Name	Causes	Possible Solutions
oL1	Motor Overload	The load is too heavy.	Decrease the load. Note: Reset <i>oL1</i> when <i>U4-16</i> [<i>Motor oL1 Level</i>] < 100.
		The acceleration/deceleration times or cycle times are too short.	<ul style="list-style-type: none"> Examine the acceleration/deceleration times and the motor start/stop frequencies (cycle times). Increase the values set in <i>C1-01</i> to <i>C1-08</i> [<i>Acceleration/Deceleration Times</i>].

7.4 Fault

Code	Name	Causes	Possible Solutions
		Overload occurred while running at low speed.	<ul style="list-style-type: none"> Decrease the load when running at low speed. Increase the motor speed. If the motor is run frequently at low speeds, replace the motor with a larger motor or use a drive-dedicated motor. <p>Note: For general-purpose motors, overload can occur while running at low speed when operating at below the rated current.</p>
		<i>L1-01 [Motor Overload (oL1) Protection]</i> is set incorrectly.	Set <i>L1-01</i> in as specified by the motor qualities for a drive-dedicated motor.
		The V/f pattern does not fit the motor qualities.	<ul style="list-style-type: none"> Examine the ratios between the V/f pattern frequency and voltage. Decrease the voltage if it is too high compared to the frequency. Adjust <i>E1-04</i> to <i>E1-10 [V/f Pattern Parameters]</i>. For motor 2, adjust <i>E3-04</i> to <i>E3-10</i>. Decrease the values set in <i>E1-08 [Mid Point A Voltage]</i> and <i>E1-10 [Minimum Output Voltage]</i>. <p>Note: If the values set in <i>E1-08</i> and <i>E1-10</i> are too low, the overload tolerance will decrease at low speeds.</p>
		<i>E1-06 [Base Frequency]</i> is set incorrectly.	Set <i>E1-06</i> to the rated frequency shown on the motor nameplate.
		One drive is operating more than one motor.	Set <i>L1-01</i> = 0 [<i>Motor Overload (oL1) Protection = Disabled</i>], connect thermal overload relay to each motor to prevent damage to the motor.
		The electronic thermal protector qualities and the motor overload properties do not align.	<ul style="list-style-type: none"> Examine the motor qualities and set <i>L1-01 [Motor Overload (oL1) Protection]</i> correctly. Connect a thermal overload relay to the motor.
		The electronic thermal protector is operating at an incorrect level.	Set <i>E2-01 [Motor Rated Current (FLA)]</i> correctly to the value specified by the motor nameplate.
		There is increased motor loss from overexcitation operation.	<ul style="list-style-type: none"> Lower the value set in <i>n3-13 [OverexcitationBraking (OEB) Gain]</i>. Set <i>L3-04</i> ≠ 4 [<i>Stall Prevention during Decel ≠ Overexcitation/ High Flux</i>]. Set <i>n3-23</i> = 0 [<i>Overexcitation Braking Operation = Disabled</i>].
		The speed search-related parameters are set incorrectly.	<ul style="list-style-type: none"> Examine the settings for all speed search related parameters. Adjust <i>b3-03 [Speed Search Deceleration Time]</i>. Set <i>b3-24</i> = 1 [<i>Speed Search Method Selection = Speed Estimation</i>] after Auto-Tuning.
		Phase loss in the input power supply is causing the output current to change.	Make sure that there is no phase loss, and repair problems.
		Overload occurred during overexcitation deceleration.	<ul style="list-style-type: none"> Decrease the value set in <i>n3-13 [OverexcitationBraking (OEB) Gain]</i>. Decrease the value set in <i>n3-21 [HSB Current Suppression Level]</i>.

Note:

- The drive detects this fault if the electronic thermal protector of the drive started the motor overload protection.
- Do a Fault Reset to clear the fault.
- L5-07 [Fault Reset Enable Select Grp1]* disables the Auto Restart function.

Code	Name	Causes	Possible Solutions
oL2	Drive Overload	The load is too large.	Decrease the load.
		The acceleration/deceleration times or cycle times are too short.	<ul style="list-style-type: none"> Examine the acceleration/deceleration times and the motor start/stop frequencies (cycle times). Increase the values set in <i>C1-01</i> to <i>C1-08 [Acceleration/Deceleration Times]</i>.
		The V/f pattern does not fit the motor qualities.	<ul style="list-style-type: none"> Examine the ratios between the V/f pattern frequency and voltage. Decrease the voltage if it is too high compared to the frequency. Adjust <i>E1-04</i> to <i>E1-10 [V/f Pattern Parameters]</i>. Decrease the values set in <i>E1-08 [Mid Point A Voltage]</i> and <i>E1-10 [Minimum Output Voltage]</i>. For motor 2, adjust <i>E3-04</i> to <i>E3-10</i>. <p>Note: If the values set in <i>E1-08</i> and <i>E1-10</i> are too low, the overload tolerance will decrease at low speeds.</p>
		The drive capacity is too small.	Replace the drive with a larger capacity model.
		Overload occurred while running at low speed.	<ul style="list-style-type: none"> Decrease the load when running at low speed. Replace the drive with a larger capacity model. Decrease the value set in <i>C6-02 [Carrier Frequency Selection]</i>.

Code	Name	Causes	Possible Solutions
		The torque compensation gain is too large.	Decrease the value set in <i>C4-01 [Torque Compensation Gain]</i> to make sure that the motor does not stall.
		The speed search-related parameters are set incorrectly.	<ul style="list-style-type: none"> Examine the settings for all speed search-related parameters. Adjust <i>b3-03 [Speed Search Deceleration Time]</i>. Set <i>b3-24 = 1 [Speed Search Method Selection = Speed Estimation]</i> after Auto-Tuning.
		Phase loss in the input power supply is causing the output current to change.	<ul style="list-style-type: none"> Correct errors with the wiring for main circuit drive input power. Make sure that there is no phase loss, and repair problems.
		Overload occurred during overexcitation deceleration.	<ul style="list-style-type: none"> Decrease the value set in <i>n3-13 [OverexcitationBraking (OEB) Gain]</i>. Decrease the value set in <i>n3-21 [HSB Current Suppression Level]</i>.
Note: <ul style="list-style-type: none"> The drive detects this fault if the electronic thermal protector of the drive started the drive overload protection. Do a Fault Reset to clear the fault. <i>L5-07 [Fault Reset Enable Select Grp1]</i> disables the Auto Restart function. 			
Code	Name	Causes	Possible Solutions
oL3	Overtorque Detection 1	A fault occurred on the machine. Example: The machine is locked.	Examine the machine and remove the cause of the fault.
		The parameters are incorrect for the load.	Adjust <i>L6-02 [Torque Detection Level 1]</i> and <i>L6-03 [Torque Detection Time 1]</i> settings.
Note: <ul style="list-style-type: none"> The drive detects this fault if the drive output current is more than the level set in <i>L6-02</i> for longer than <i>L6-03</i>. Do a Fault Reset to clear the fault. If the drive detects this fault, it will operate the motor as specified by the Stopping Method set in <i>L6-01 [Torque Detection Selection 1]</i>. <i>L5-07 [Fault Reset Enable Select Grp1]</i> disables the Auto Restart function. 			
Code	Name	Causes	Possible Solutions
oL4	Overtorque Detection 2	A fault occurred on the machine. Example: The machine is locked.	Examine the machine and remove the cause of the fault.
		The parameters are incorrect for the load.	Adjust <i>L6-05 [Torque Detection Level 2]</i> and <i>L6-06 [Torque Detection Time 2]</i> settings.
Note: <ul style="list-style-type: none"> The drive detects this fault if the drive output current is more than the level set in <i>L6-05</i> for longer than <i>L6-06</i>. Do a Fault Reset to clear the fault. If the drive detects this fault, it will operate the motor as specified by the Stopping Method set in <i>L6-04 [Torque Detection Selection 2]</i>. <i>L5-07 [Fault Reset Enable Select Grp1]</i> disables the Auto Restart function. 			
Code	Name	Causes	Possible Solutions
oL5	Mechanical Weakening Detection 1	The drive detected overtorque as specified by the conditions for mechanical weakening detection set in <i>L6-08 [Mechanical Fatigue Detect Select]</i> .	Do a deterioration diagnostic test on the machine side.
Note: <ul style="list-style-type: none"> Do a Fault Reset to clear the fault. If the drive detects this fault, it will operate the motor as specified by the Stopping Method set in <i>L6-08</i>. 			
Code	Name	Causes	Possible Solutions
oL7	High Slip Braking Overload	The load inertia is too large.	<ul style="list-style-type: none"> Decrease deceleration times in <i>C1-02, C1-04, C1-06, and C1-08 [Deceleration Times]</i> for applications that do not use High Slip Braking. Use a braking resistor to decrease the deceleration time.
		An external force on the load side rotated the motor.	
		Something is preventing deceleration on the load side.	<ul style="list-style-type: none"> Increase the value set in <i>n3-04</i>. Connect a thermal overload relay to the motor, and set <i>n3-04 = 1200 s (maximum value)</i>.
		The value set in <i>n3-04 [HSB Overload Time]</i> is too small.	
Note: <ul style="list-style-type: none"> The drive detects this fault if the output frequency is constant for longer than <i>n3-04</i>. Do a Fault Reset to clear the fault. 			

7.4 Fault

Code	Name	Causes	Possible Solutions
oPr	Keypad Connection Fault	The keypad is not securely connected to the connector on the drive.	Examine the connection between the keypad and the drive.
		The connection cable between the drive and the keypad is disconnected.	<ul style="list-style-type: none"> Remove the keypad and then reconnect it. Replace the cable if damaged.
Note: <ul style="list-style-type: none"> The drive detects this fault if these conditions are correct: <ul style="list-style-type: none"> -o2-06 = 1 [Keypad Disconnect Detection = Enabled]. -b1-02 = 0 [Run Command Selection 1 = Keypad], or the drive is operating in LOCAL Mode with the keypad. Do a Fault Reset to clear the fault. 			
Code	Name	Causes	Possible Solutions
oS	Overspeed	There is overshoot.	<ul style="list-style-type: none"> Decrease C5-01 [ASR Proportional Gain 1] and increase C5-02 [ASR Integral Time 1]. Adjust the pulse train gain with H6-02 to H6-05 [Pulse Train Input Setting Parameters].
		There is an incorrect number of PG pulses set in the drive.	Set H6-02 [Terminal RP Frequency Scaling] to the pulse train frequency during 100% reference (maximum motor rotation speed).
		The oS detection level is set incorrectly.	Adjust F1-08 [Overspeed Detection Level] and F1-09 [Overspeed Detection Delay Time].
		If the drive detects the fault at start or in the low speed range (10% or less) and n8-57 = 1 [HF1 Overlap Selection = Enabled] for PM Control methods, the high frequency injection gain is too high.	<ul style="list-style-type: none"> Set E5-xx [PM Motor Parameters] correctly or do Rotational Auto-Tuning. Decrease the value of n8-41 [HF1 P Gain] in 0.5 unit increments. Note: Set n8-41 > 0.0 for IPM motors.
Note: <ul style="list-style-type: none"> The drive detects this fault if the motor speed is more than the value set in F1-08 for longer than F1-09. Do a Fault Reset to clear the fault. If the drive detects this fault, it will operate the motor as specified by the Stopping Method set in F1-03 [Overspeed Detection Selection]. 			
Code	Name	Causes	Possible Solutions
ov	Overvoltage	The deceleration time is too short and too much regenerative energy is flowing back into the drive.	<ul style="list-style-type: none"> Set L3-04 = 1 [Stall Prevention during Decel = General Purpose]. Increase the values set in C1-02, C1-04, C1-06, or C1-08 [Deceleration Times]. Connect a dynamic braking option to the drive. Perform Deceleration Rate Tuning.
		The acceleration time is too short.	<ul style="list-style-type: none"> Make sure that sudden drive acceleration does not cause the fault. Increase the values set in C1-01, C1-03, C1-05, or C1-07 [Acceleration Times]. Increase the value set in C2-02 [S-Curve Time @ End of Accel]. Set L3-11 = 1 [Overvoltage Suppression Select = Enabled].
		The braking load is too large.	Connect a dynamic braking option to the drive.
		There are surge voltages in the input power supply.	Connect a DC link choke to the drive. Note: If you turn the phase advancing capacitors ON and OFF and use thyristor converters in the same power supply system, there can be surge voltages that irregularly increase the input voltage.
		The drive output cable or motor is shorted to ground (the current short to ground is charging the main circuit capacitor of the drive through the power supply).	<ol style="list-style-type: none"> Examine the motor main circuit cable, terminals, and motor terminal box, and then remove ground faults. Re-energize the drive.
		The speed search-related parameters are set incorrectly (this fault also occurs during recovery from momentary power loss and after Auto Restarts).	<ul style="list-style-type: none"> Examine the settings for all speed search related parameters. Set b3-19 ≠ 0 [Speed Search Restart Attempts ≠ 0 times]. Adjust b3-03 [Speed Search Deceleration Time]. Do Stationary Auto-Tuning for Line-to-Line Resistance and set b3-24 = 1 [Speed Search Method Selection = Speed Estimation].
		The power supply voltage is too high.	Decrease the power supply voltage to match the drive rated voltage.
		The braking resistor or braking resistor unit wiring is incorrect.	Correct wiring errors in the connection to the braking resistor or braking resistor unit.
		The encoder cable is disconnected or wired incorrectly.	Examine for wiring errors or disconnected wires in the encoder cable, and repair problems.
		Noise interference along the encoder cable.	Isolate the encoder cable from the drive output line or a different source of electrical interference.

Code	Name	Causes	Possible Solutions
		Electrical interference caused a drive malfunction.	<ul style="list-style-type: none"> Examine the control circuit lines, main circuit lines, and ground wiring, and decrease the effects of electrical interference. Make sure that a magnetic contactor is not the source of the electrical interference, then use a Surge Protective Device if necessary.
		The load inertia is set incorrectly.	<ul style="list-style-type: none"> Examine the load inertia settings with KEB, overvoltage suppression, or stall prevention during deceleration. Adjust <i>L3-25 [Load Inertia Ratio]</i> to match the qualities of the machine.
		The Short Circuit Braking function used in OLV/PM control method.	Connect a braking resistor to the drive.
		There is motor hunting.	<ul style="list-style-type: none"> Adjust <i>n1-02 [Hunting Prevention Gain Setting]</i>. Adjust <i>n2-02 [Automatic Freq Regulator Time 1]</i> and <i>n2-03 [Automatic Freq Regulator Time 2]</i>. Adjust <i>n8-45 [Speed Feedback Detection Gain]</i> and <i>n8-47 [Pull-in Current Comp Filter Time]</i>.
		Speed Search at Start does not complete correctly when: <ul style="list-style-type: none"> A1-02 = 8 [Control Method Selection = EZOLV] E9-01 = 0 [Motor Type Selection = Induction (IM)] 	Set <i>b3-24 = 2 [Speed Search Method Selection = Current Detection 2]</i> .
Note: <ul style="list-style-type: none"> The drive detects this error if the DC bus voltage is more than the <i>ov</i> detection level while the drive is running. Do a Fault Reset to clear the fault. For 200 V class drives, the detection level of <i>ov</i> is approximately 410 V. For 400 V class drives, the detection level is approximately 820 V. <i>L5-08 [Fault Reset Enable Select Grp2]</i> disables the Auto Restart function. 			
Code	Name	Causes	Possible Solutions
PE1, PE2	PLC Faults	The communication option detected a fault.	Refer to the manual for the communication option card.
Note: Do a Fault Reset to clear the fault.			
Code	Name	Causes	Possible Solutions
PF	Input Phase Loss	There is a phase loss in the drive input power.	Correct errors with the wiring for main circuit drive input power.
		There is loose wiring in the drive input power terminals.	Tighten the terminal screws to the correct tightening torque.
		The drive input power voltage is changing too much.	<ul style="list-style-type: none"> Examine the input power for problems. Make the drive input power stable. If the input power supply is good, examine the magnetic contactor on the main circuit side for problems.
		There is unsatisfactory balance between voltage phases.	<ul style="list-style-type: none"> Examine the input power for problems. Make the drive input power stable. Set <i>L8-05 = 0 [Input Phase Loss Protection Sel = Disabled]</i>.
		The main circuit capacitors have become unserviceable.	<ul style="list-style-type: none"> Examine the capacitor maintenance time in monitor <i>U4-05 [Capacitor Maintenance]</i>. If <i>U4-05</i> is more than 90%, replace the control board or the drive. For information about replacing the control board, contact Yaskawa or your nearest sales representative. If drive input power is correct and the fault stays, replace the control board or the drive. For information about replacing the control board, contact Yaskawa or your nearest sales representative.
Note: <ul style="list-style-type: none"> The drive detects this error if the DC bus voltage changes irregularly without regeneration. Do a Fault Reset to clear the fault. Use <i>L8-05</i> to enable and disable <i>PF</i> detection. 			
Code	Name	Causes	Possible Solutions
PGo	Encoder (PG) Feedback Loss	The encoder cable is disconnected or wired incorrectly.	Examine for wiring errors or disconnected wires in the encoder cable, and repair problems.
		The encoder is not receiving power.	Examine the encoder power supply.
		The holding brake is stopping the motor.	Release the holding brake.
Note: <ul style="list-style-type: none"> The drive detects this error if it does not receive the speed detection pulse signal from the encoder in the detection time set in <i>F1-14 [Encoder Open-Circuit Detect Time]</i>. Do a Fault Reset to clear the fault. If the drive detects this error, it will operate the motor as specified by the Stopping Method set in <i>F1-02 [PG Open Circuit Detection Select]</i>. 			

7.4 Fault

Code	Name	Causes	Possible Solutions
PGoH	Encoder (PG) Hardware Fault	The encoder cable is disconnected.	Connect any disconnected wires in the encoder cable.
Note: <ul style="list-style-type: none"> Do a Fault Reset to clear the fault. Parameter <i>F1-20 [Encoder 1 PCB Disconnect Detect]</i> or <i>F1-36 [Encoder 2 PCB Disconnect Detect]</i> enables and disables PGoH detection. If the drive detects this error, it will operate the motor as specified by the Stopping Method set in <i>F1-02 [PG Open Circuit Detection Select]</i>. 			
Code	Name	Causes	Possible Solutions
rF	Braking Resistor Fault	The resistance of the dynamic braking option that is connected to the drive is too low.	Use a dynamic braking option that fits the model and duty rating of the drive.
		A regenerative converter, regenerative unit, or braking unit is connected to the drive.	Set <i>L8-55 = 0 [Internal DB Transistor Protection = Disable]</i> .
Note: Do a Fault Reset to clear the fault.			
Code	Name	Causes	Possible Solutions
rH	Braking Resistor Overheat	The deceleration time is too short and excessive regenerative energy is flowing back into the drive.	<ul style="list-style-type: none"> Check the load level, deceleration time, and speed. Decrease the load. Increase the values set in <i>C1-02, C1-04, C1-06, or C1-08 [Deceleration Times]</i>. Use a dynamic braking option that lets you use more power.
		The duty cycle is too high.	Examine the duty cycle. Note: When <i>L8-01 = 1 [3% ERF DB Resistor Protection = Enabled]</i> , the maximum braking duty cycle is 3%.
		The braking load is too heavy.	<ul style="list-style-type: none"> Calculate the braking load and braking power again, and decrease the braking load. Use a braking resistor that improves braking power.
		The braking resistor is not sufficient.	Use the braking resistor specifications to select a sufficient braking resistor.
Note: <ul style="list-style-type: none"> The drive detects this error if the braking resistor overheat protective function is active. The magnitude of the braking load causes the braking resistor overheat alarm, NOT the surface temperature. If the duty cycle is higher than the braking resistor rating, the drive will show the alarm. Do a Fault Reset to clear the fault. Parameter <i>L8-01</i> enables and disables <i>rH</i> detection. 			
Code	Name	Causes	Possible Solutions
rr	Dynamic Braking Transistor Fault	The drive control circuit is damaged.	<ul style="list-style-type: none"> Re-energize the drive.
		There is a malfunction in the internal braking transistor of the drive.	<ul style="list-style-type: none"> If the fault stays, replace the control board or the drive. For information about replacing the control board, contact Yaskawa or your nearest sales representative.
Note: Do a Fault Reset to clear the fault.			
Code	Name	Causes	Possible Solutions
SC	Short Circuit/IGBT Failure	Overheating caused damage to the motor or the motor insulation is not satisfactory.	Measure the motor insulation resistance, and replace the motor if there is electrical conduction or unserviceable insulation.
		The motor main circuit cable is contacting ground to make a short circuit.	<ul style="list-style-type: none"> Examine the motor main circuit cable for damage, and repair short circuits. Measure the resistance between the motor main circuit cable and the ground terminal. If there is electrical conduction, replace the cable.
		A short circuit or ground fault on the drive output side caused damage to the output transistor of the drive.	<ul style="list-style-type: none"> Make sure that there is not a short circuit in terminal B1 and terminals U/T1, V/T2, and W/T3. Make sure that there is not a short circuit in terminals - and terminals U/T1, V/T2, and W/T3. If there is a short circuit, contact Yaskawa or your nearest sales representative.
		When <i>A1-02 = 5, 6, 7 [Control Method Selection = OLV/PM, AOLV/PM, or CLV/PM]</i> , the output current is more than the value set in <i>L8-27 [Overcurrent Detection Gain]</i> .	Set <i>L8-27</i> correctly.
Note: <ul style="list-style-type: none"> The drive detects this error if there is a short circuit or ground fault on the drive output side, or an IGBT failure. Do a Fault Reset to clear the fault. 			

Code	Name	Causes	Possible Solutions
SCF	Safety Circuit Fault	The safety circuit is broken.	Replace the control board or the drive. For information about replacing the control board, contact Yaskawa or your nearest sales representative.
Note: Do a Fault Reset to clear the fault.			
Code	Name	Causes	Possible Solutions
SEr	Speed Search Retries Exceeded	The speed search-related parameters are set incorrectly.	<ul style="list-style-type: none"> Decrease the value set in <i>b3-10</i> [<i>Speed Estimation Detection Gain</i>]. Increase the value set in <i>b3-17</i> [<i>Speed Est Retry Current Level</i>]. Increase the value set in <i>b3-18</i> [<i>Speed Est Retry Detection Time</i>]. Do Auto-Tuning again.
		The motor is coasting in the opposite direction of the Run command.	Set <i>b3-14</i> = 1 [<i>Bi-directional Speed Search = Enabled</i>].
Note: <ul style="list-style-type: none"> The drive detects this error if the number of speed search restarts is more than the value set in <i>b3-19</i> [<i>Speed Search Restart Attempts</i>]. Do a Fault Reset to clear the fault. 			
Code	Name	Causes	Possible Solutions
STPo	Motor Step-Out Detected	The motor code is set incorrectly for PM Control Methods.	<ul style="list-style-type: none"> Set <i>E5-01</i> [<i>PM Motor Code Selection</i>] correctly as specified by the motor. For specialized motors, refer to the motor test report and set <i>E5-xx</i> correctly.
		The load is too large.	<ul style="list-style-type: none"> Increase the value set in <i>n8-55</i> [<i>Motor to Load Inertia Ratio</i>]. Increase the value set in <i>n8-51</i> [<i>Pull-in Current @ Acceleration</i>]. If the drive detects <i>STPo</i> during deceleration when increasing the value set in <i>n8-51</i>, set the value of <i>n8-79</i> [<i>Pull-in Current @ Deceleration</i>] lower than <i>n8-51</i>. Decrease the load. Replace the drive and motor with larger capacity models.
		The load inertia is too large.	Increase the value set in <i>n8-55</i> .
		The acceleration/deceleration times are too short.	<ul style="list-style-type: none"> Increase the values set in <i>C1-01</i> to <i>C1-08</i> [<i>Acceleration/Deceleration Times</i>]. Increase the value set in <i>C2-01</i> [<i>S-Curve Time @ Start of Accel</i>].
		Speed response is too slow.	Increase the value set in <i>n8-55</i> .
Note: Do a Fault Reset to clear the fault.			
Code	Name	Causes	Possible Solutions
SvE	Zero Servo Fault	The value set in the torque limit is too small.	Adjust torque limit-related parameters <i>L7-01</i> to <i>L7-04</i> .
		The load torque is too large.	Decrease the load torque.
		Noise interference along the encoder cable	Isolate the encoder cable from the drive output line or a different source of electrical interference.
Note: <ul style="list-style-type: none"> The drive detects this error if motor rotation position moves during Zero Servo. Do a Fault Reset to clear the fault. 			
Code	Name	Causes	Possible Solutions
TiM	Keypad Time Not Set	There is a battery in the keypad, but the date and time are not set.	Use the keypad to set the date and time.
Note: <ul style="list-style-type: none"> Do a Fault Reset to clear the fault. Parameter <i>o4-24</i> [<i>bAT Detection Selection</i>] enables and disables <i>TiM</i> detection. 			
Code	Name	Causes	Possible Solutions
UL3	Undertorque Detection 1	A fault occurred on the machine. Example: There is a broken pulley belt.	Examine the machine and remove the cause of the fault.
		The parameters are incorrect for the load.	Adjust <i>L6-02</i> [<i>Torque Detection Level 1</i>] and <i>L6-03</i> [<i>Torque Detection Time 1</i>] settings.
Note: <ul style="list-style-type: none"> The drive detects this error if the drive output current is less than the level set in <i>L6-02</i> for longer than <i>L6-03</i>. Do a Fault Reset to clear the fault. If the drive detects this error, it will operate the motor as specified by the Stopping Method set in <i>L6-01</i> [<i>Torque Detection Selection 1</i>]. 			

7.4 Fault

Code	Name	Causes	Possible Solutions
UL4	Undertorque Detection 2	A fault occurred on the machine. Example: There is a broken pulley belt.	Examine the machine and remove the cause of the fault.
		The parameters are incorrect for the load.	Adjust L6-05 [Torque Detection Level 2] and L6-06 [Torque Detection Time 2] settings.
Note: <ul style="list-style-type: none"> The drive detects this error if the drive output current is less than the level set in L6-05 for longer than L6-06. Do a Fault Reset to clear the fault. If the drive detects this error, it will operate the motor as specified by the Stopping Method set in L6-04 [Torque Detection Selection 2]. 			
Code	Name	Causes	Possible Solutions
UL5	Mechanical Weakening Detection 2	The drive detected undertorque as specified by the conditions for mechanical weakening detection set in L6-08 [Mechanical Fatigue Detect Select].	Examine the machine for deterioration.
Note: <ul style="list-style-type: none"> Do a Fault Reset to clear the fault. If the drive detects this error, it will operate the motor as specified by the Stopping Method set in L6-08. 			
Code	Name	Causes	Possible Solutions
Uv1	DC Bus Undervoltage	There is a phase loss in the drive input power.	Correct errors with the wiring for main circuit drive input power.
		There is loose wiring in the drive input power terminals.	Tighten the terminal screws to the correct tightening torque.
		The drive input power voltage is changing too much.	<ul style="list-style-type: none"> Examine the input power for problems. Make the drive input power stable. If the input power supply is good, examine the magnetic contactor on the main circuit side for problems.
		There was a loss of power.	Use a better power supply.
		The main circuit capacitors have become unserviceable.	Examine the capacitor maintenance time in monitor U4-05 [Capacitor Maintenance]. If U4-05 is more than 90%, replace the control board or the drive. For information about replacing the control board, contact Yaskawa or your nearest sales representative.
		The relay or contactor on the soft-charge bypass relay is damaged.	U4-06 [PreChargeRelayMainte] shows the performance life of the soft-charge bypass relay. If U4-06 is more than 90%, replace the board or the drive. For information about replacing the board, contact Yaskawa or your nearest sales representative.
Note: <ul style="list-style-type: none"> The drive detects this error if the DC bus voltage decreases below the level set in L2-05 [Undervoltage Detection Lvl (Uv1)] while the drive is running. The Uv1 detection level is approximately 190 V for a 200 V class drives. The detection level is approximately 380 V for 400 V class drives. The detection level is approximately 350 V when E1-01 [Input AC Supply Voltage] < 400. Do a Fault Reset to clear the fault. Fault trace is not available for this fault. L5-08 [Fault Reset Enable Select Grp2] disables the Auto Restart function. 			
Code	Name	Causes	Possible Solutions
Uv2	Control Power Undervoltage	The value set in L2-02 [Power Loss Ride Through Time] increased and the momentary power loss recovery unit is not connected to the drive.	Connect the momentary power loss recovery unit to the drive.
		There was a problem with the drive hardware.	<ul style="list-style-type: none"> Re-energize the drive. If the fault stays, replace the control board or the drive. For information about replacing the control board, contact Yaskawa or your nearest sales representative.
Note: <ul style="list-style-type: none"> The drive detects this error if the control power supply voltage decreases. Do a Fault Reset to clear the fault. Fault trace is not available for this fault. 			
Code	Name	Causes	Possible Solutions
Uv3	Soft Charge Answerback Fault	The relay or contactor on the soft-charge bypass relay is damaged.	<ul style="list-style-type: none"> Re-energize the drive. If the fault stays, replace the control board or the drive. Check monitor U4-06 [PreChargeRelayMainte] shows the performance life of the soft-charge bypass relay. If U4-06 is more than 90%, replace the board or the drive. For information about replacing the control board, contact Yaskawa or your nearest sales representative.
Note: <ul style="list-style-type: none"> Do a Fault Reset to clear the fault. Fault trace is not available for these faults. 			

7.5 Minor Faults/Alarms

This section gives information about the causes and possible solutions when a minor fault or alarm occurs. Use the information in this table to remove the cause of the minor fault or alarm.

Code	Name	Causes	Possible Solutions
AEr	Station Address Setting Error	The node address for the communication option is not in the permitted setting range.	<ul style="list-style-type: none"> For CC-Link communication, set F6-10 [CC-Link Node Address] correctly. For MECHATROLINK communication, set F6-20 [MECHATROLINK Station Address] correctly. For CANopen communication, set F6-35 [CANopen Node ID Selection] correctly.
Note: If the drive detects this error, the terminal set to H2-01 to H2-03 = 10 [MFDO Function Select = Alarm] will activate.			
Code	Name	Causes	Possible Solutions
bAT	Keypad Battery Low Voltage	The keypad battery voltage is low.	Replace the keypad battery.
Note: • If detected, the terminal assigned to H2-01 to H2-03 = 10 [MFDO Function Select = Alarm] will switch ON. • Set o4-24 [bAT Detection Selection] to enable/disable bAT detection.			
Code	Name	Causes	Possible Solutions
bb	Baseblock	An external baseblock command was entered through one of the MFDI terminals Sx, and the drive output stopped as shown by an external baseblock command.	Examine the external sequence and timing of the baseblock command input.
Note: The drive will not output a minor fault signal for this alarm.			
Code	Name	Causes	Possible Solutions
bCE	Bluetooth Communication Error	The smartphone or tablet with DriveWizard Mobile installed is too far from the keypad.	Use the smartphone or tablet 10 m (32.8 ft.) or nearer to the keypad. Note: bCE can occur when the smartphone or tablet is 10 m (32.8 ft.) or nearer to the keypad depending on the specifications of the smartphone or tablet.
		Radio waves from a different device are causing interference with communications between the smartphone or tablet and keypad.	Make sure that no device around the keypad uses the same radio bandwidth (2400 MHz to 2480 MHz), and prevent radio interference.
Note: • The drive detects this error when you use the Bluetooth LCD keypad to operate the drive from a smartphone or tablet. • If the drive detects this error, the terminal set to H2-01 to H2-03 = 10 [MFDO Function Selection = Alarm] will activate. • Parameter o2-27 [bCE Detection Selection] enables and disables bCE detection.			
Code	Name	Causes	Possible Solutions
boL	Braking Transistor Overload	The duty cycle of the braking transistor is high (the regeneration power or repetition frequency is high).	<ul style="list-style-type: none"> Install a braking unit (CDBR series). Install a regenerative converter. Increase the deceleration time.
		You enabled the protective function for the braking transistor when you have a regenerative converter.	Set L8-55 = 0 [Internal DB TransistorProtection = Disable].
		The braking transistor in the drive is broken.	Replace the drive.
Note: If the drive detects this error, the terminal assigned to H2-01 to H2-03 = 10 [MFDO Function Select = Alarm] will be ON.			
Code	Name	Causes	Possible Solutions
bUS	Option Communication Error	The communications cable wiring is incorrect.	Correct wiring errors.
		There is a short-circuit in the communications cable or the communications cable is not connected.	<ul style="list-style-type: none"> Repair short circuits and connect cables. Replace the defective communications cable.
		Electrical interference caused a communication data error.	<ul style="list-style-type: none"> Examine the control circuit lines, main circuit lines, and ground wiring, and decrease the effects of electrical interference. Make sure that a magnetic contactor is not the source of the electrical interference, then use a Surge Protective Device if necessary. Use only the recommended cables or other shielded line. Ground the shield on the controller side or the drive input power side. Separate the communication wiring from drive power lines, and install a noise filter to the input side of the power supply for communication. Decrease the effects of electrical interference from the controller.
		The option card is incorrectly installed to the drive.	Correctly install the option card to the drive.

7.5 Minor Faults/Alarms

Code	Name	Causes	Possible Solutions
		The option card is damaged.	If the alarm continues and the wiring is correct, replace the option card.
Note: <ul style="list-style-type: none"> The drive detects this error if the Run command or frequency reference is assigned to the option card. If the drive detects this error, the terminal set to <i>H2-01 to H2-03 = 10 [MFDO Function Select = Alarm]</i> will activate. If the drive detects this error, it will operate the motor as specified by the stopping method set in <i>F6-01 [Communication Error Selection]</i>. 			
Code	Name	Causes	Possible Solutions
CALL	Serial Comm Transmission Error	The communications cable wiring is incorrect.	Correct wiring errors.
		There is a short circuit in the communications cable or the communications cable is not connected.	<ul style="list-style-type: none"> Repair the short-circuited or disconnected portion of the cable. Replace the defective communications cable.
		A programming error occurred on the controller side.	Examine communications at start-up and correct programming errors.
		There is damage to the communications circuitry.	<ul style="list-style-type: none"> Do a self-diagnostics check. If the problem continues, replace the control board or the drive. Contact Yaskawa or your nearest sales representative to replace the control board.
		The termination resistor setting for MEMOBUS/Modbus communications is incorrect.	On the last drive in a MEMOBUS/Modbus network, set DIP switch S2 to the ON position to enable the termination resistor.
Note: <ul style="list-style-type: none"> The drive detects this error if it does not correctly receive control data from the controller when energizing the drive. If the drive detects this error, the terminal assigned to <i>H2-01 to H2-03 = 10 [MFDO Function Select = Alarm]</i> will activate. 			
Code	Name	Causes	Possible Solutions
CE	Modbus Communication Error	The communications cable wiring is incorrect.	Correct wiring errors.
		There is a short circuit in the communications cable or the communications cable is not connected.	<ul style="list-style-type: none"> Repair short circuits and connect cables. Replace the defective communications cable.
		Electrical interference caused a communication data error.	<ul style="list-style-type: none"> Examine the control circuit lines, main circuit lines, and ground wiring, and decrease the effects of electrical interference. Make sure that a magnetic contactor is not the source of the electrical interference, then use a Surge Protective Device if necessary. Use only the recommended cables or other shielded line. Ground the shield on the controller side or the drive input power side. Separate the communication wiring from drive power lines, and install a noise filter to the input side of the power supply for communication. Decrease the effects of electrical interference from the controller.
		The communication protocol is not compatible.	<ul style="list-style-type: none"> Examine the values set in <i>H5-xx</i>. Examine the settings on the controller side and correct the difference in communication conditions.
		The value set in <i>H5-09 [CE Detection Time]</i> is too small for the communications cycle.	<ul style="list-style-type: none"> Change the controller software settings. Increase the value set in <i>H5-09</i>.
		The controller software or hardware is causing a communication problem.	Examine the controller and remove the cause of the problem.
Note: <ul style="list-style-type: none"> The drive detects this error if it does not correctly receive control data for the <i>CE</i> detection time set to <i>H5-09</i>. If the drive detects this error, the terminal assigned to <i>H2-01 to H2-03 = 10 [MFDO Function Select = Alarm]</i> will be ON. If the drive detects this error, it will operate the motor as specified by the stopping method set in <i>H5-04 [Communication Error Stop Method]</i>. 			
Code	Name	Causes	Possible Solutions
CP1	Comparator 1 Limit Error	The monitor value set in <i>H2-20 [Comparator 1 Monitor Selection]</i> was in the range of <i>H2-21 [Comparator 1 Lower Limit]</i> and <i>H2-22 [Comparator 1 Upper Limit]</i> .	Examine the monitor value and remove the cause of the error.
Note: <ul style="list-style-type: none"> The drive detects this error when the terminal is assigned to <i>H2-01 to H2-03 = 66 [MFDO Function Select = Comparator1]</i>. If the drive detects this error, the terminal assigned to <i>H2-01 to H2-03 = 10 [MFDO Function Select = Alarm]</i> will be ON. <i>H2-33 [Comparator1 Protection Selection]</i> enables and disables <i>CP1</i> detection. 			
Code	Name	Causes	Possible Solutions
CP2	Comparator 2 Limit Error	The monitor value set in <i>H2-26 [Comparator 2 Monitor Selection]</i> was outside the range of <i>H2-27 [Comparator 2 Lower Limit]</i> and <i>H2-28 [Comparator 2 Upper Limit]</i> .	Examine the monitor value and remove the cause of the error.
Note: <ul style="list-style-type: none"> The drive detects this error when the terminal is assigned to <i>H2-01 to H2-03 = 67 [MFDO Function Select = Comparator2]</i>. If the drive detects this error, the terminal assigned to <i>H2-01 to H2-03 = 10 [MFDO Function Select = Alarm]</i> will be ON. <i>H2-35 [Comparator2 Protection Selection]</i> enables and disables <i>CP2</i> detection. 			

Code	Name	Causes	Possible Solutions
CrST	Cannot Reset	The drive received a fault reset command when a Run command was active.	Turn off the Run command then de-energize and re-energize the drive.
Code	Name	Causes	Possible Solutions
CyC	MECHATROLINK CommCycleSettingErr	The communications cycle setting of the controller is not in the permitted range of the MECHATROLINK interface option.	Set the communications cycle of the controller in the permitted range of the MECHATROLINK interface option.
Note: If the drive detects this error, the terminal set to H2-01 to H2-03 = 10 [MFDO Function Select = Alarm] will activate.			
Code	Name	Causes	Possible Solutions
CyPo	Cycle Power to Accept Changes	Although F6-15 = 1 [Comm. Option Parameters Reload = Reload Now], the drive does not update the communication option parameters.	Re-energize the drive to update the communication option parameters.
Code	Name	Causes	Possible Solutions
dEv	Speed Deviation	The load is too heavy	Decrease the load.
		Acceleration and deceleration times are set too short.	Increase the values set in C1-01 to C1-08 [Acceleration/Deceleration Time].
		The dEv detection level settings are incorrect.	Adjust F1-10 [Speed Deviation Detection Level] and F1-11 [Speed Deviation Detect DelayTime].
		The load is locked up.	Examine the machine.
		The holding brake is stopping the motor.	Release the holding brake.
Note: <ul style="list-style-type: none"> The drive detects this error if the difference between the detected speed and the speed reference is more than the setting of F1-10 for longer than F1-11. If the drive detects this error, the terminal assigned to H2-01 to H2-03 = 10 [MFDO Function Select = Alarm] will be ON. If the drive detects this error, the drive will operate the motor as specified by the stopping method set in F1-04 [Speed Deviation Detection Select]. 			
Code	Name	Causes	Possible Solutions
dnE	Drive Disabled	A terminal set for H1-xx = 6A [Drive Enable] turned OFF.	Examine the operation sequence.
Note: If the drive detects this error, the terminal assigned to H2-01 to H2-03 = 10 [MFDO Function Select = Alarm] will be ON.			
Code	Name	Causes	Possible Solutions
dWA2	DriveWorksEZ Alarm 2	There was an error in the DriveWorksEZ program.	Examine the DriveWorksEZ program and remove the cause of the error. This is not a drive fault.
Note: If the drive detects this error, the terminal assigned to H2-01 to H2-03 = 10 [MFDO Function Select = Alarm] will be ON.			
Code	Name	Causes	Possible Solutions
dWA3	DriveWorksEZ Alarm 3	There was an error in the DriveWorksEZ program.	Examine the DriveWorksEZ program and remove the cause of the error. This is not a drive fault.
Note: If the drive detects this error, the terminal assigned to H2-01 to H2-03 = 10 [MFDO Function Select = Alarm] will be ON.			
Code	Name	Causes	Possible Solutions
dWAL	DriveWorksEZ Alarm	There was an error in the DriveWorksEZ program.	Examine the DriveWorksEZ program and remove the cause of the error. This is not a drive fault.
Note: If the drive detects this error, the terminal assigned to H2-01 to H2-03 = 10 [MFDO Function Select = Alarm] will be ON.			
Code	Name	Causes	Possible Solutions
E5	MECHATROLINK Watchdog Timer Err	The drive detected a watchdog circuit exception while it received data from the controller.	Examine the MECHATROLINK cable connection. If this error occurs frequently, examine the wiring and decrease the effects of electrical interference as specified by these manuals: <ul style="list-style-type: none"> MECHATROLINK-II Installation Guide (MECHATROLINK Members Association, manual number MMATDEP011) MECHATROLINK-III Installation Manual (MECHATROLINK Members Association, publication number MMATDEP018)
Note: <ul style="list-style-type: none"> If the drive detects this error, the terminal assigned to H2-01 to H2-03 = 10 [MFDO Function Select = Alarm] will be ON. If the drive detects this error, it will operate the motor as specified by the stop method set in F6-25 [MECHATROLINK Watchdog Error Sel]. 			

7.5 Minor Faults/Alarms

Code	Name	Causes	Possible Solutions
EF	FWD/REV Run Command Input Error	A forward command and a reverse command were input at the same time for longer than 0.5 s.	Examine the forward and reverse command sequence and correct the problem.
Note: <ul style="list-style-type: none"> If the drive detects <i>EF</i>, the motor will ramp to stop. If the drive detects this error, the terminal assigned to <i>H2-01 to H2-03 = 10 [MFDO Function Select = Alarm]</i> will be ON. 			
Code	Name	Causes	Possible Solutions
EF0	Option Card External Fault	The communication option card received an external fault from the controller.	<ol style="list-style-type: none"> Find the device that caused the external fault and remove the cause. Clear the external fault input from the controller.
		Programming error occurred on the controller side.	Examine the operation of the controller program.
Note: <ul style="list-style-type: none"> The drive detects this error if the alarm function on the external device side is operating. If the drive detects this error, the terminal assigned to <i>H2-01 to H2-03 = 10 [MFDO Function Select = Alarm]</i> will be ON. Set the stopping method for this fault in <i>F6-03 [Comm External Fault (EF0) Select]</i>. 			
Code	Name	Causes	Possible Solutions
EF1	External Fault (Terminal S1)	MFDI terminal S1 caused an external fault through an external device.	<ol style="list-style-type: none"> Find the device that caused the external fault and remove the cause. Clear the external fault input in the MFDI.
		The wiring is incorrect.	Correctly connect the signal line to MFDI terminal S1.
		<i>External Fault [H1-01 = 2C to 2F]</i> is set to MFDI terminal S1, but the terminal is not in use.	Correctly set the MFDI.
Note: <p>If the drive detects this error, the terminal assigned to <i>H2-01 to H2-03 = 10 [MFDO Function Select = Alarm]</i> will be ON.</p>			
Code	Name	Causes	Possible Solutions
EF2	External Fault (Terminal S2)	MFDI terminal S2 caused an external fault through an external device.	<ol style="list-style-type: none"> Find the device that caused the external fault and remove the cause. Clear the external fault input in the MFDI.
		The wiring is incorrect.	Correctly connect the signal line to MFDI terminal S2.
		<i>External Fault [H1-02 = 2C to 2F]</i> is set to MFDI terminal S2, but the terminal is not in use.	Correctly set the MFDI.
Note: <p>If the drive detects this error, the terminal assigned to <i>H2-01 to H2-03 = 10 [MFDO Function Select = Alarm]</i> will be ON.</p>			
Code	Name	Causes	Possible Solutions
EF3	External Fault (Terminal S3)	MFDI terminal S3 caused an external fault through an external device.	<ol style="list-style-type: none"> Find the device that caused the external fault and remove the cause. Clear the external fault input in the MFDI.
		The wiring is incorrect.	Correctly connect the signal line to MFDI terminal S3.
		<i>External Fault [H1-03 = 2C to 2F]</i> is set to MFDI terminal S3, but the terminal is not in use.	Correctly set the MFDI.
Note: <p>If the drive detects this error, the terminal assigned to <i>H2-01 to H2-03 = 10 [MFDO Function Select = Alarm]</i> will be ON.</p>			
Code	Name	Causes	Possible Solutions
EF4	External Fault (Terminal S4)	MFDI terminal S4 caused an external fault through an external device.	<ol style="list-style-type: none"> Find the device that caused the external fault and remove the cause. Clear the external fault input in the MFDI.
		The wiring is incorrect.	Correctly connect the signal line to MFDI terminal S4.
		<i>External Fault [H1-04 = 2C to 2F]</i> is set to MFDI terminal S4, but the terminal is not in use.	Correctly set the MFDI.
Note: <p>If the drive detects this error, the terminal assigned to <i>H2-01 to H2-03 = 10 [MFDO Function Select = Alarm]</i> will be ON.</p>			
Code	Name	Causes	Possible Solutions
EF5	External Fault (Terminal S5)	MFDI terminal S5 caused an external fault through an external device.	<ol style="list-style-type: none"> Find the device that caused the external fault and remove the cause. Clear the external fault input in the MFDI.
		The wiring is incorrect.	Correctly connect the signal line to MFDI terminal S5.
		<i>External Fault [H1-05 = 2C to 2F]</i> is set to MFDI terminal S5, but the terminal is not in use.	Correctly set the MFDI.
Note: <p>If the drive detects this error, the terminal assigned to <i>H2-01 to H2-03 = 10 [MFDO Function Select = Alarm]</i> will be ON.</p>			

Code	Name	Causes	Possible Solutions
EF6	External Fault (Terminal S6)	MFDI terminal S6 caused an external fault through an external device.	<ol style="list-style-type: none"> Find the device that caused the external fault and remove the cause. Clear the external fault input in the MFDI.
		The wiring is incorrect.	Correctly connect the signal line to MFDI terminal S6.
		<i>External Fault [H1-06 = 2C to 2F]</i> is set to MFDI terminal S6, but the terminal is not in use.	Correctly set the MFDI.
Note: If the drive detects this error, the terminal assigned to <i>H2-01 to H2-03 = 10 [MFDO Function Select = Alarm]</i> will be ON.			
Code	Name	Causes	Possible Solutions
EF7	External Fault (Terminal S7)	MFDI terminal S7 caused an external fault through an external device.	<ol style="list-style-type: none"> Find the device that caused the external fault and remove the cause. Clear the external fault input in the MFDI.
		The wiring is incorrect.	Correctly connect the signal line to MFDI terminal S7.
		<i>External Fault [H1-07 = 2C to 2F]</i> is set to MFDI terminal S7, but the terminal is not in use.	Correctly set the MFDI.
Note: If the drive detects this error, the terminal assigned to <i>H2-01 to H2-03 = 10 [MFDO Function Select = Alarm]</i> will be ON.			
Code	Name	Causes	Possible Solutions
EF8	External Fault (Terminal S8)	MFDI terminal S8 caused an external fault through an external device.	<ol style="list-style-type: none"> Find the device that caused the external fault and remove the cause. Clear the external fault input in the MFDI.
		The wiring is incorrect.	Correctly connect the signal line to MFDI terminal S8.
		<i>External Fault [H1-08 = 2C to 2F]</i> is set to MFDI terminal S8, but the terminal is not in use.	Correctly set the MFDI.
Note: If the drive detects this error, the terminal assigned to <i>H2-01 to H2-03 = 10 [MFDO Function Select = Alarm]</i> will be ON.			
Code	Name	Causes	Possible Solutions
EP24v	External Power 24V Supply	The voltage of the main circuit power supply decreased, and the 24 V power supply is supplying power to the drive.	<ul style="list-style-type: none"> Examine the main circuit power supply. Turn ON the main circuit power supply to run the drive.
Note: <ul style="list-style-type: none"> Set <i>o2-26 [Ext. Power 24V Supply Display]</i> to enable or disable <i>EP24v</i> detection. The drive will not output an alarm signal for this alarm. 			
Code	Name	Causes	Possible Solutions
FbH	Excessive PID Feedback	The <i>FbH</i> detection level is set incorrectly.	Adjust <i>b5-36 [PID High Feedback Detection Lvl]</i> and <i>b5-37 [PID High Feedback Detection Time]</i> .
		There is a problem with the PID feedback wiring.	Correct errors with the PID control wiring.
		The feedback sensor is not operating correctly.	Examine the sensors on the control device side.
		A fault occurred in the feedback input circuit of the drive.	Replace the control board or the drive. For information about replacing the control board, contact Yaskawa or your nearest sales representative.
Note: <ul style="list-style-type: none"> The drive detects this fault if the PID feedback input is more than the level set in <i>b5-36</i> for longer than <i>b5-37</i>. If detected, the terminal assigned to <i>H2-01 to H2-03 = 10 [MFDO Function Select = Alarm]</i> will be ON. If the drive detects this fault, it will operate the motor as specified by the stop method set in <i>b5-12 [Feedback Loss Detection Select]</i>. 			
Code	Name	Causes	Possible Solutions
FbL	PID Feedback Loss	The <i>FbL</i> detection level is set incorrectly.	Adjust <i>b5-13 [PID Feedback Loss Detection Lvl]</i> and <i>b5-14 [PID Feedback Loss Detection Time]</i> .
		There is a problem with the PID feedback wiring.	Correct errors with the PID control wiring.
		The feedback sensor is not operating correctly.	Examine the sensors on the control device side.
		A fault occurred in the feedback input circuit of the drive.	Replace the control board or the drive. For information about replacing the control board, contact Yaskawa or your nearest sales representative.
Note: <ul style="list-style-type: none"> The drive detects this error if the PID feedback input is lower than the level set in <i>b5-13</i> for longer than <i>b5-14</i>. If the drive detects this error, the terminal assigned to <i>H2-01 to H2-03 = 10 [MFDO Function Select = Alarm]</i> will be ON. If the drive detects this error, it will operate the motor as specified by the stop method set in <i>b5-12 [Feedback Loss Detection Select]</i>. 			

7.5 Minor Faults/Alarms

Code	Name	Causes	Possible Solutions
HCA	High Current Alarm	The load is too heavy.	<ul style="list-style-type: none"> Decrease the load for applications with repetitive starts and stops. Replace the drive with a larger capacity model.
		The acceleration time is too short.	<ul style="list-style-type: none"> Calculate the torque necessary during acceleration related to the load inertia and the specified acceleration time. Increase the values set in <i>C1-01, C1-03, C1-05, or C1-07 [Acceleration Times]</i> until you get the necessary torque. Increase the values set in <i>C2-01 to C2-04 [S-Curve Characteristics]</i> until you get the necessary torque. Replace the drive with a larger capacity model.
		The drive is trying to operate a specialized motor or a motor that is larger than the maximum applicable motor output of the drive.	<ul style="list-style-type: none"> Examine the motor nameplate, the motor, and the drive to make sure that the drive rated current is larger than the motor rated current. Replace the drive with a larger capacity model.
		The current level temporarily increased because of speed search after a momentary power loss or while trying to Auto Restart.	If speed search or Auto Restart cause an increase in current, the drive can temporarily show this alarm. The time that the drive shows the alarm is short. No more steps are necessary to clear the alarm.
Note: <ul style="list-style-type: none"> The drive detects this error if the drive output current is more than the overcurrent alarm level (150% of the rated current). If the drive detects this error, the terminal assigned to <i>H2-01 to H2-03 = 10 [MFDO Function Select = Alarm]</i> will be ON. 			
Code	Name	Causes	Possible Solutions
L24v	Loss of External Power 24 Supply	The voltage of the backup 24 V power supply has decreased. The main circuit power supply is operating correctly.	<ul style="list-style-type: none"> Examine the external 24 V power supply for disconnected wires and wiring errors and repair the problems. Examine the external 24 V power supply for problems.
Note: <ul style="list-style-type: none"> Set <i>o2-23 [External 24V Powerloss Detection]</i> to enable or disable <i>L24v</i> detection. The drive will not output an alarm signal for this alarm. 			
Code	Name	Causes	Possible Solutions
LoG	Com Error / Abnormal SD card	There is not a micro SD in the keypad.	Put a micro SD card in the keypad.
		<ul style="list-style-type: none"> The drive is connected to USB. The number of log communication files is more than 1000. The micro SD card does not have available memory space. The line number data in a log communication file is not correct. A communication error between the keypad and drive occurred during a log communication. 	Set <i>o5-01 = 0 [Log Start/Stop Selection = OFF]</i> .
Note: <ul style="list-style-type: none"> If the drive detects this error, the terminal set to <i>H2-01 to H2-03 = 6A [MFDO Function Selection = Data Logger Error]</i> will activate. 			
Code	Name	Causes	Possible Solutions
LT-1	Cooling Fan Maintenance Time	The cooling fan is at 90% of its expected performance life.	<ol style="list-style-type: none"> Replace the cooling fan. Set <i>o4-03 = 0 [Fan Operation Time Setting = 0 h]</i> to reset the cooling fan operation time.
Note: <ul style="list-style-type: none"> When the estimated performance life is expired, the terminal set to <i>H2-01 to H2-03 = 2F [MFDO Function Selection = Maintenance Notification]</i> will activate. 			
Code	Name	Causes	Possible Solutions
LT-2	Capacitor Maintenance Time	The capacitors for the main circuit and control circuit are at 90% of expected performance life.	Replace the control board or the drive. For information about replacing the control board, contact Yaskawa or your nearest sales representative.
Note: <ul style="list-style-type: none"> When the estimated performance life is expired, the terminal assigned to <i>H2-01 to H2-03 = 2F [MFDO Function Select = Maintenance Notification]</i> will be ON. 			
Code	Name	Causes	Possible Solutions
LT-3	SoftChargeBypassRelay MainteTime	The soft charge bypass relay is at 90% of its expected performance life.	Replace the control board or the drive. For information about replacing the control board, contact Yaskawa or your nearest sales representative.
Note: <ul style="list-style-type: none"> When the estimated performance life is expired, the terminal assigned to <i>H2-01 to H2-03 = 2F [MFDO Function Select = Maintenance Notification]</i> will be ON. 			
Code	Name	Causes	Possible Solutions
LT-4	IGBT Maintenance Time (50%)	The IGBT is at 50% of its expected performance life.	Check the load, carrier frequency, and output frequency.
Note: <ul style="list-style-type: none"> When the estimated performance life is expired, the terminal assigned to <i>H2-01 to H2-03 = 2F [MFDO Function Select = Maintenance Notification]</i> will be ON. 			

Code	Name	Causes	Possible Solutions
oH	Heatsink Overheat	The ambient temperature is high and the heatsink temperature is more than the L8-02 [Overheat Alarm Level].	<ul style="list-style-type: none"> Measure the ambient temperature. Increase the airflow around the drive. Install a cooling device (cooling fan or air conditioner) to lower the ambient temperature. Remove objects near the drive that are producing too much heat.
		There is not sufficient airflow around the drive.	<ul style="list-style-type: none"> Give the drive the correct installation space as shown in the manual. Make sure that there is sufficient circulation around the control panel. Examine the drive for dust or other unwanted materials that could clog the cooling fan. Remove unwanted materials that prevent air circulation.
		The internal cooling fan or fans have stopped.	<ol style="list-style-type: none"> Use the procedures in this manual to replace the cooling fan. Set o4-03 = 0 [Fan Operation Time Setting = 0 h] to reset the cooling fan operation time.
<p>Note:</p> <ul style="list-style-type: none"> The drive detects this error if the heatsink temperature of the drive is more than L8-02. If the drive detects this error, the terminal assigned to H2-01 to H2-03 = 10 [MFDO Function Select = Alarm] will be ON. Set the stopping method for this fault in L8-03 [Overheat Pre-Alarm Selection]. 			
Code	Name	Causes	Possible Solutions
oH2	External Overheat (H1-XX=B)	An external device sent an oH2.	<ol style="list-style-type: none"> Find the external device that output the overheat alarm. Remove the cause of the problem. Clear the Overheat Alarm (oH2) [H1-xx = B] that was set to MFDI terminals S1 to S8.
<p>Note:</p> <p>If the drive detects this error, the terminal assigned to H2-01 to H2-03 = 10 [MFDO Function Select = Alarm] will be ON.</p>			
Code	Name	Causes	Possible Solutions
oH3	Motor Overheat (PTC Input)	The thermistor wiring that detects motor temperature is defective.	Correct wiring errors.
		A fault occurred on the machine. Example: The machine is locked.	Examine the machine and remove the cause of the fault
		The motor has overheated.	<ul style="list-style-type: none"> Check the load level, acceleration/deceleration time, and motor start/stop frequency (cycle time). Decrease the load. Increase the values set in C1-01 to C1-08 [Acceleration/Deceleration Times]. Set E2-01 [Motor Rated Current (FLA)] correctly to the value specified by the motor nameplate. Make sure that the motor cooling system is operating correctly, and repair or replace it if it is damaged. Adjust E1-04 to E1-10 [V/f Pattern Parameters]. For motor 2, adjust E3-04 to E3-10. Decrease the values set in E1-08 [Mid Point A Voltage] and E1-10 [Minimum Output Voltage]. <p>Note:</p> <p>If the values set in E1-08 and E1-10 are too low, the overload tolerance will decrease at low speeds.</p>
<p>Note:</p> <ul style="list-style-type: none"> When H3-02, H3-10, or H3-06 = E [MFAI Function Select = Motor Temperature (PTC Input)], the drive detects this fault if the motor overheat signal entered to analog input terminals A1 to A3 is more than the alarm detection level. If the drive detects this error, the terminal set to H2-01 to H2-03 = 10 [MFDO Function Select = Alarm] will activate. If the drive detects this error, it will operate the motor as specified by the stopping method set in L1-03 [Motor Thermistor oH Alarm Select]. 			
Code	Name	Causes	Possible Solutions
oL3	Overtorque 1	A fault occurred on the machine. Example: The machine is locked.	Examine the machine and remove the cause of the fault.
		The parameters are incorrect for the load.	Adjust L6-02 [Torque Detection Level 1] and L6-03 [Torque Detection Time 1] settings.
<p>Note:</p> <ul style="list-style-type: none"> The drive detects this fault if the drive output current is more than the level set in L6-02 for longer than L6-03. If the drive detects this error, the terminal assigned to H2-01 to H2-03 = 10 [MFDO Function Select = Alarm] will be ON. Set the conditions that trigger the minor fault using L6-01 [Torque Detection Selection 1]. 			

7.5 Minor Faults/Alarms

Code	Name	Causes	Possible Solutions
oL4	Overtorque 2	A fault occurred on the machine. Example: The machine is locked.	Examine the machine and remove the cause of the fault.
		The parameters are incorrect for the load.	Adjust L6-05 [Torque Detection Level 2] and L6-06 [Torque Detection Time 2] settings.
Note: <ul style="list-style-type: none"> The drive detects this error if the drive output current is more than the level set in L6-05 for longer than L6-06. If the drive detects this error, the terminal assigned to H2-01 to H2-03 = 10 [MFDO Function Select = Alarm] will be ON. Set the conditions that trigger the minor fault using L6-04 [Torque Detection Selection 2]. 			
Code	Name	Causes	Possible Solutions
oL5	Mechanical Weakening Detection 1	The drive detected overtorque as specified by the conditions for mechanical weakening detection set in L6-08 [Mechanical Fatigue Detect Select].	Do a deterioration diagnostic test on the machine side.
Note: <ul style="list-style-type: none"> If the drive detects this error, the terminal assigned to H2-01 to H2-03 = 10 [MFDO Function Select = Alarm] will be ON. If the drive detects this minor fault, it will operate the motor as specified by the Stopping Method set in L6-08. 			
Code	Name	Causes	Possible Solutions
oS	Overspeed	There is overshoot.	<ul style="list-style-type: none"> Decrease C5-01 [ASR Proportional Gain 1] and increase C5-02 [ASR Integral Time 1]. Use H6-02 to H6-05 [Pulse Train Input Setting Parameters] to adjust the pulse train gain.
		There is an incorrect number of PG pulses set in the drive.	Set H6-02 [Terminal RP Frequency Scaling] to the pulse train frequency during 100% reference (maximum motor rotation speed).
		The oS detection level is set incorrectly.	Adjust F1-08 [Overspeed Detection Level] and F1-09 [Overspeed Detection Delay Time].
Note: <ul style="list-style-type: none"> The drive detects this error if the motor speed is more than the value set in F1-08 for longer than F1-09. If the drive detects this error, the terminal set to H2-01 to H2-03 = 10 [MFDO Function Select = Alarm] will activate. If the drive detects this error, it will operate the motor as specified by the stopping method set in F1-03 [Overspeed Detection Selection]. 			
Code	Name	Causes	Possible Solutions
ov	DC Bus Overvoltage	There are surge voltages in the input power supply.	Connect a DC link choke to the drive. Note: If you turn the phase advancing capacitors ON and OFF and use thyristor converters in the same power supply system, there can be surge voltages that irregularly increase the input voltage.
		The drive output cable or motor is shorted to ground. (The current short to ground is charging the main circuit capacitor of the drive through the power supply.)	<ol style="list-style-type: none"> Examine the motor main circuit cable, terminals, and motor terminal box, and then remove ground faults. Re-energize the drive.
		The power supply voltage is too high.	Decrease the power supply voltage to match the drive rated voltage.
		Electrical interference caused a drive malfunction.	<ul style="list-style-type: none"> Examine the control circuit lines, main circuit lines, and ground wiring, and decrease the effects of electrical interference. Make sure that a magnetic contactor is not the source of the electrical interference, then use a Surge Protective Device if necessary. Set L5-01 $\neq 0$ [Number of Auto-Restart Attempts $\neq 0$ times].
Note: <ul style="list-style-type: none"> The drive detects this error if the DC bus voltage is more than the ov detection level when the Run command has not been input (while the drive is stopped). The ov detection level is approximately 410 V with 200 V class drives. The detection level is approximately 820 V for 400 V class drives. If the drive detects this error, the terminal assigned to H2-01 to H2-03 = 10 [MFDO Function Select = Alarm] will be ON. 			
Code	Name	Causes	Possible Solutions
PASS	Modbus Communication Test	The MEMOBUS/Modbus communications test is complete.	The PASS display will turn off after communications test mode is cleared.
Code	Name	Causes	Possible Solutions
PF	Input Phase Loss	There is a phase loss in the drive input power.	Correct all wiring errors with the main circuit power supply.
		Loose wiring in the input power terminals.	Tighten the screws to the correct tightening torque.
		The drive input power voltage is changing too much.	<ul style="list-style-type: none"> Examine the supply voltage for problems. Make the drive input power stable.
		Unsatisfactory balance between voltage phases.	<ul style="list-style-type: none"> Examine the supply voltage for problems. Make the drive input power stable. If the supply voltage is good, examine the magnetic contactor on the main circuit side for problems.

Code	Name	Causes	Possible Solutions
		The main circuit capacitors have become unserviceable.	<ul style="list-style-type: none"> Examine the capacitor maintenance time in monitor <i>U4-05 [CapacitorMaintenance]</i>. If <i>U4-05</i> is more than 90%, replace the capacitor. Contact Yaskawa or your nearest sales representative for more information.
			<ul style="list-style-type: none"> Examine the supply voltage for problems. Re-energize the drive. If the alarm stays, replace the circuit board or the drive. Contact Yaskawa or your nearest sales representative for more information.
Note: <ul style="list-style-type: none"> The drive detects this error if the DC bus voltage changes irregularly without regeneration. If the drive detects this error, the terminal assigned to <i>H2-01 to H2-03 = 10 [MFDO Function Select = Alarm]</i> will be ON. Use <i>L8-05 [Input Phase Loss Protection Sel]</i> to enable and disable <i>PF</i> detection. 			
Code	Name	Causes	Possible Solutions
PGo	Encoder (PG) Feedback Loss	The encoder cable is disconnected or wired incorrectly.	Examine for wiring errors or disconnected wires in the encoder cable, and repair problems.
		The encoder is not receiving power.	Examine the encoder power supply.
		The holding brake is stopping the motor.	Release the holding brake.
Note: <ul style="list-style-type: none"> The drive detects this error if it does not receive the speed detection pulse signal from the encoder in the detection time set in <i>F1-14 [Encoder Open-Circuit Detect Time]</i>. If the drive detects this error, the terminal assigned to <i>H2-01 to H2-03 = 10 [MFDO Function Select = Alarm]</i> will be ON. If the drive detects this error, it will operate the motor as specified by the Stopping Method set in <i>F1-02 [PG Open Circuit Detection Select]</i>. 			
Code	Name	Causes	Possible Solutions
PGoH	Encoder (PG) Hardware Fault	The encoder cable is disconnected.	Correct any disconnected wires in the encoder cable.
Note: <ul style="list-style-type: none"> If the drive detects this error, the terminal set to <i>H2-01 to H2-03 = 10 [MFDO Function Select = Alarm]</i> will activate. Parameters <i>F1-20 [Encoder 1 PCB Disconnect Detect]</i> or <i>F1-36 [Encoder 2 PCB Disconnect Detect]</i> enable and disable <i>PGoH</i> detection. If the drive detects this error, it will operate the motor as specified by the stopping method set in <i>F1-02 [PG Open Circuit Detection Select]</i>. 			
Code	Name	Causes	Possible Solutions
rUn	Motor Switch during Run	The drive received a <i>Motor 2 Selection [H1-xx = 16]</i> during run.	Make sure that the drive receives the Motor 2 Selection while the drive is stopped.
Note: <ul style="list-style-type: none"> If the drive detects this error, the terminal assigned to <i>H2-01 to H2-03 = 10 [MFDO Function Select = Alarm]</i> will be ON. 			
Code	Name	Causes	Possible Solutions
SE	Modbus Test Mode Error	MEMOBUS/Modbus communications self-diagnostics [<i>H1-xx = 67</i>] was done while the drive was running.	Stop the drive and do MEMOBUS/Modbus communications self-diagnostics.
Note: <ul style="list-style-type: none"> If detected, the terminal assigned to <i>H2-01 to H2-03 = 10 [MFDO Function Select = Alarm]</i> will be ON. 			
Code	Name	Causes	Possible Solutions
STo	Safe Torque OFF	Safe Disable inputs H1-HC and H2-HC are open.	<ul style="list-style-type: none"> Make sure that the Safe Disable signal is input from an external source to terminal H1-HC and H2-HC. When the Safe Disable function is not in use, use a jumper to connect terminals H1-HC and H2-HC.
		There is internal damage to the two Safe Disable channels.	Replace the board or the drive. Contact Yaskawa or your nearest sales representative to replace the board.
Note: <ul style="list-style-type: none"> The drive will not output an alarm signal for this alarm. If the drive detects this error, the terminal set to <i>H2-01 to H2-03 = 21 [MFDO Function Select = Safe Torque OFF]</i> will activate. 			
Code	Name	Causes	Possible Solutions
SToF	Safe Torque OFF Hardware	One of the two terminals H1-HC or H2-HC received the Safe Disable input signal.	<ul style="list-style-type: none"> Make sure that the Safe Disable signal is input from an external source to terminals H1-HC or H2-HC. When the Safe Disable function is not in use, use a jumper to connect terminals H1-HC and H2-HC.
		The Safe Disable input signal is wired incorrectly.	
		There is internal damage to one Safe Disable channel.	Replace the board or the drive. Contact Yaskawa or your nearest sales representative to replace the board.
Note: <ul style="list-style-type: none"> If the drive detects this error, the terminal set to <i>H2-01 to H2-03 = 10 [MFDO Function Select = Alarm]</i> will activate. 			

7.5 Minor Faults/Alarms

Code	Name	Causes	Possible Solutions
TiM	Keypad Time Not Set	You put a battery in the keypad, but you have not set the date and time.	Set the date and time with the keypad.
Note: <ul style="list-style-type: none"> Parameter <i>o4-24 [bAT Detection Selection]</i> enables and disables <i>TiM</i> detection. If the drive detects this error, the terminal set to <i>H2-01 to H2-03 = 10 [MFDO Function Selection = Alarm]</i> will activate. 			
Code	Name	Causes	Possible Solutions
TrPC	IGBT Maintenance Time (90%)	The IGBT is at 90% of its expected performance life.	Replace the IGBT or the drive. Contact Yaskawa or your nearest sales representative for more information.
Note: <p>If the drive detects this error, the terminal set to <i>H2-01 to H2-03 = 10 [MFDO Function Selection = Alarm]</i> will activate.</p>			
Code	Name	Causes	Possible Solutions
UL3	Undertorque Detection 1	A fault occurred on the machine. Example: There is a broken pulley belt.	Examine the machine and remove the cause of the fault.
		The parameters are incorrect for the load.	Adjust <i>L6-02 [Torque Detection Level 1]</i> and <i>L6-03 [Torque Detection Time 1]</i> settings.
Note: <ul style="list-style-type: none"> The drive detects this error if the drive output current is less than the level set in <i>L6-02</i> for longer than <i>L6-03</i>. If the drive detects this error, the terminal assigned to <i>H2-01 to H2-03 = 10 [MFDO Function Select = Alarm]</i> will be ON. If the drive detects this error, it will operate the motor as specified by the Stopping Method set in <i>L6-01 [Torque Detection Selection 1]</i>. 			
Code	Name	Causes	Possible Solutions
UL4	Undertorque Detection 2	A fault occurred on the machine. Example: There is a broken pulley belt.	Examine the machine and remove the cause of the fault.
		The parameters are incorrect for the load.	Adjust <i>L6-05 [Torque Detection Level 2]</i> and <i>L6-06 [Torque Detection Time 2]</i> settings.
Note: <ul style="list-style-type: none"> The drive detects this error if the drive output current is less than the level set in <i>L6-05</i> for longer than <i>L6-06</i>. If detected, the terminal assigned to <i>H2-01 to H2-03 = 10 [MFDO Function Select = Alarm]</i> will be ON. If the drive detects this error, it will operate the motor as specified by the Stopping Method set in <i>L6-04 [Torque Detection Selection 2]</i>. 			
Code	Name	Causes	Possible Solutions
UL5	Mechanical Weakening Detection 2	The drive detected undertorque as specified by the conditions for mechanical weakening detection set in <i>L6-08 [Mechanical Fatigue Detect Select]</i> .	Examine the machine for deterioration.
Note: <ul style="list-style-type: none"> If the drive detects this error, the terminal assigned to <i>H2-01 to H2-03 = 10 [MFDO Function Select = Alarm]</i> will be ON. If the drive detects this error, it will operate the motor as specified by the Stopping Method set in <i>L6-08</i>. 			
Code	Name	Causes	Possible Solutions
Uv	Undervoltage	The drive input power voltage is changing too much.	<ul style="list-style-type: none"> Examine the input power for problems. Make the drive input power stable. If the input power supply is good, examine the magnetic contactor on the main circuit side for problems.
		There is a phase loss in the drive input power.	Correct errors with the wiring for main circuit drive input power.
		There is loose wiring in the drive input power terminals.	Tighten the terminal screws to the correct tightening torque.
		There was a loss of power.	Use a better power supply.
		The main circuit capacitors have become unserviceable.	Examine the capacitor maintenance time in monitor <i>U4-05 [Capacitor Maintenance]</i> . If <i>U4-05</i> is more than 90%, replace the control board or the drive. For information about replacing the control board, contact Yaskawa or your nearest sales representative.
		The drive input power transformer is too small and voltage drops when the power is switched on.	<ul style="list-style-type: none"> Check for an alarm when a molded-case circuit breaker, Leakage Breaker (ELCB, GFCL, or RCM/RCD) (with overcurrent protective function), or magnetic contactor is ON. Check the capacity of the drive power supply transformer.
		Air inside the drive is too hot.	Check the ambient temperature of the drive.
		The Charge LED is broken.	Replace the control board or the entire drive. For information about replacing the control board, contact Yaskawa or your nearest sales representative.
Note: <ul style="list-style-type: none"> The drive detects this error if one of these conditions is correct when the Run command has not been input (while the drive is stopped). <ul style="list-style-type: none"> The DC bus voltage < <i>L2-05 [Undervoltage Detection Lvl (Uv1)]</i>. The Contactor that prevents inrush current in the drive was opened. There is low voltage in the control drive input power. If the drive detects this error, the terminal assigned to <i>H2-01 to H2-03 = 10 [MFDO Function Select = Alarm]</i> will be ON. 			

7.6 Parameter Setting Errors

Parameter setting errors occur when multiple parameter settings do not agree, or when parameter setting values are not correct. Refer to the table in this section, examine the parameter setting that caused the error, and remove the cause of the error. You must first correct the parameter setting errors before you can operate the drive. The drive will not send notification signals for the faults and alarms when these parameter setting errors occur.

Code	Name	Causes	Possible Solutions
oPE01	Drive Capacity Setting Error	The value set in <i>o2-04 [Drive Model (KVA) Selection]</i> does not agree with the drive model.	Set <i>o2-04</i> to the correct value.
Code	Name	Causes	Possible Solutions
oPE02	Parameter Range Setting Error	Parameters settings are not in the applicable setting range.	<ol style="list-style-type: none"> Push  to show <i>U1-18 [oPE Fault Parameter]</i>, and find parameters that are not in the applicable setting range. Correct the parameter settings. <p>Note: If more than one error occurs at the same time, other <i>oPExx</i> errors have priority over <i>oPE02</i>.</p>
		Set $E2-01 \leq E2-03$ [<i>Motor Rated Current (FLA) ≤ Motor No-Load Current</i>].	<p>Make sure that $E2-01 > E2-03$.</p> <p>Note: If it is necessary to set $E2-01 < E2-03$, first lower the value set in $E2-03$, and then set $E2-01$.</p>
Code	Name	Causes	Possible Solutions
oPE03	Multi-Function Input Setting Err	The settings for these parameters do not agree: <ul style="list-style-type: none"> <i>F3-10 to F3-25 [Terminal D1 to DF Function Selection]</i> <i>H1-01 to H1-08 [Terminals S1 to S8 Function Selection]</i> <i>H7-01 to H7-04 [Virtual Multi-Function Inputs 1 to 4]</i> 	Correct the parameter settings.
		The settings for the standby mode function do not agree: <ul style="list-style-type: none"> $b8-50 = 0$ [<i>Standby Mode Selection = Disabled</i>] and $H2-xx = 65$ [<i>MFDO Function Select = Standby Output</i>] $b8-50 = 1$ [<i>Enabled</i>] and $H2-xx \neq 65$ 	Correct the parameter settings.
		The settings for MFDIs overlap. <p>Note: This does not include $H1-xx = 20$ to $2F$ [<i>MFDI Function Select = External Fault</i>] and [<i>Reserved</i>].</p>	Set the parameters correctly to prevent MFDI function overlap.
		These pairs of MFDI functions are not set to Digital Inputs ($H1-xx$, $F3-10$ to $F3-25$, and $H7-01$ to $H7-04$) at the same time: <ul style="list-style-type: none"> Setting values 10 [<i>Up Command</i>] and 11 [<i>Down Command</i>] Setting values 75 [<i>Up 2 Command</i>] and 76 [<i>Down 2 Command</i>] Setting values 42 [<i>Run Command (2-Wire Sequence 2)</i>] and 43 [<i>FWD/REV (2-Wire Sequence 2)</i>] 	Set the MFDI pairs.
		A minimum of two of these MFDI combinations are set to Digital Inputs ($H1-xx$, $F3-10$ to $F3-25$, and $H7-01$ to $H7-04$) at the same time: <ul style="list-style-type: none"> Setting values 10 [<i>Up Command</i>] and 11 [<i>Down Command</i>] Setting values 75 [<i>Up 2 Command</i>] and 76 [<i>Down 2 Command</i>] Setting value A [<i>Accel/Decel Ramp Hold</i>] Setting value $1E$ [<i>Reference Sample Hold</i>] Setting values 44 to 46 [<i>Add Offset Frequency 1 to 3 (d7-01 to d7-03)</i>] 	Remove the function settings that are not in use.
		The parameter settings are enabled at the same time. <ul style="list-style-type: none"> $b5-01$ [<i>PID Mode Setting</i>] $H1-xx = 10$ [<i>Up Command</i>] $H1-xx = 11$ [<i>Down Command</i>] 	<ul style="list-style-type: none"> Set $b5-01 = 0$ [<i>Disabled</i>]. Remove the function Up/Down command settings.

7.6 Parameter Setting Errors

Code	Name	Causes	Possible Solutions
		<p>These commands are set in Digital Inputs (H1-xx, F3-10 to F3-25, and H7-01 to H7-04) at the same time:</p> <ul style="list-style-type: none"> Setting values 61 [Speed Search from Fmax] and 62 [Speed Search from Fref] Setting values 65, 66, 7A, 7B [KEB Ride-Thru 1 or 2 Activate] and 68 [High Slip Braking (HSB) Activate] Setting values 16 [Motor 2 Selection] and 1A [Accel/Decel Time Selection 2] Setting values 65, 66 [KEB Ride-Thru 1 Activate] and 7A, 7B [KEB Ride-Thru 2 Activate] Setting values 40, 41 [Forward RUN (2-Wire), Reverse RUN (2-Wire)] and 42, 43 [Run Command (2-Wire Sequence 2), FWD/REV (2-Wire Sequence 2)] Setting values 60 [DC Injection Braking Command] and 6A [Drive Enable] Setting values 16 [Motor 2 Selection] and 75, 76 [Up 2 Command, Down 2 Command] 	Remove the function settings that are not in use.
		<p>Settings for N.C. and N.O. input [H1-xx] for these functions were selected at the same time:</p> <ul style="list-style-type: none"> Setting value 15 [Fast Stop (N.O.)] Setting value 17 [Fast Stop (N.C.)] 	Remove one of the function settings.
		<p>These settings were entered while H1-xx = 2 [External Reference 1/2 Selection]:</p> <ul style="list-style-type: none"> b1-15 = 4 [Frequency Reference Selection 2 = Pulse Train Input] H6-01 ≠ 0 [Terminal RP Pulse Train Function ≠ Frequency Reference] 	Set H6-01 = 0.
		<p>These settings were entered while H1-xx = 2 [External Reference 1/2 Selection]:</p> <ul style="list-style-type: none"> b1-15 = 3 [Option PCB] or b1-16 = 3 [Run Command Selection 2 = Option PCB] No option card is connected to the drive. 	Connect an input option card to the drive.
		<p>These settings were entered while H1-xx = 2 [External Reference 1/2 Selection]:</p> <ul style="list-style-type: none"> b1-15 = 1 [Analog Input] H3-02 ≠ 0 [Terminal A1 Function Selection ≠ Frequency Reference] or H3-10 ≠ 0 [Terminal A2 Function Selection ≠ Frequency Reference] 	Set H3-02 = 0 or H3-10 = 0.
		<p>These parameters are set at the same time:</p> <ul style="list-style-type: none"> H1-xx ≠ 6A [Drive Enable] H2-xx = 38 [Drive Enabled] 	Correct the parameter settings.
		<p>These parameters are set at the same time:</p> <ul style="list-style-type: none"> H6-01 ≠ 3 [PG Speed Feedback (V/F Control)] H1-xx = 7E [Reverse Rotation Identifier] 	Correct the parameter settings.
		<p>These parameters are set at the same time:</p> <ul style="list-style-type: none"> H1-xx = 75/76 [Up 2 /Down 2 Command] H3-01, H3-05, H3-09 = 1 [Terminal A1, A2, A3 Signal Level Select = -10 to +10V (Bipolar Reference)] 	Remove one of the function settings.
		<p>These parameters are set at the same time:</p> <ul style="list-style-type: none"> H1-xx = 62 [Speed Search from Fref] H5-22 = 1 [Speed Search from MODBUS = Enabled] 	Remove one of the function settings.
		<p>These settings do not agree:</p> <ul style="list-style-type: none"> A PG-RT3 option is connected to the drive. H1-xx = 16 [Motor 2 Selection] is set. 	<p>Correct the parameter settings.</p> <p>Note: The Motor Switch function is not available with the PG-RT3 option.</p>
Code	Name	Causes	Possible Solutions
oPE05	Run Cmd/Freq Ref Source Sel Err	<p>The setting to assign the Run command or frequency reference to an option card or the pulse train input is incorrect.</p>	Correct the parameter settings.
		<p>b1-01 = 3 [Frequency Reference Selection 1 = Option PCB] is set, but there is no option card connected to the drive.</p>	Connect an option card to the drive.
		<p>b1-02 = 3 [Run Command Selection 1 = Option PCB] is set, but there is no option card connected to the drive.</p>	

Code	Name	Causes	Possible Solutions
		The following parameters are set at the same time: <ul style="list-style-type: none"> • $b1-01 = 4$ [Pulse Train Input] • $H6-01 \neq 0$ [Terminal RP Pulse Train Function \neq Frequency Reference] 	Set $H6-01 = 0$.
		The following parameters are set at the same time: <ul style="list-style-type: none"> • $F3-01 = 6$ [Digital Input Function Selection = BCD (5-digit), 0.01 Hz] • $F3-03 = 0, 1$ [Digital Input Data Length Select = 8-bit, 12-bit] 	Set $F3-03 = 2$ [16-bit].
		These parameters are set and there is an AI-A3 option card connected to the drive: <ul style="list-style-type: none"> • $H1-xx = 2$ [External Reference 1/2 Selection] • $b1-15 = 3$ [Frequency Reference Selection 2 = Option PCB] • $F2-01 = 0$ [Analog Input Function Selection = 3 Independent Channels] 	Correct the parameter settings.
Code	Name	Causes	Possible Solutions
oPE06	Control Method Selection Error	$A1-02 = 1, 3, \text{ or } 7$ [Control Method Selection = CLV/f, CLV, CLV/PM] is set, but there is no encoder option card connected to the drive.	<ul style="list-style-type: none"> • Connect an encoder option card to the drive. • Set $A1-02$ correctly.
Code	Name	Causes	Possible Solutions
oPE07	Analog Input Selection Error	The settings for $H3-02, H3-06, \text{ and } H3-10$ [MFAI Function Select] and $H7-30$ [Virtual Analog Input Selection] overlap.	Set $H3-02, H3-06, H3-10, \text{ and } H7-30$ correctly to prevent overlap. Note: It is possible to set these functions to multiple analog input terminals at the same time: <ul style="list-style-type: none"> • Setting value 0 [Frequency Reference] • Setting values F and $1F$ [Not Used]
		The following parameters are set at the same time: <ul style="list-style-type: none"> • $H3-02, H3-06, H3-10, H7-30 = B$ [PID Feedback] • $H6-01 = 1$ [Terminal RP Pulse Train Function = PID Feedback Value] 	Remove the function settings that are not in use.
		The following parameters are set at the same time: <ul style="list-style-type: none"> • $H3-02, H3-06, H3-10, H7-30 = C$ [PID Setpoint] • $H6-01 = 2$ [PID Setpoint Value] 	
		The following parameters are set at the same time: <ul style="list-style-type: none"> • $H3-02, H3-06, H3-10, H7-30 = C$ • $b5-18 = 1$ [b5-19 PID Setpoint Selection = Enabled] 	
		The following parameters are set at the same time: <ul style="list-style-type: none"> • $H6-01 = 2$ • $b5-18 = 1$ 	
Code	Name	Causes	Possible Solutions
oPE08	Parameter Selection Error	You set a function that is not compatible with the control method set in $A1-02$ [Control Method Selection].	<ol style="list-style-type: none"> 1. Push  to show $U1-18$ [oPE Fault Parameter], and find parameters that are not in the applicable setting range. 2. Correct the parameter settings. Note: If more than one error occurs at the same time, other oPExx errors have priority over oPE02.
		When $A1-02 = 2$ [Control Method Selection = OLV], you used these parameter settings: <ul style="list-style-type: none"> • $n2-02 > n2-03$ [Automatic Freq Regulator Time 1 > Automatic Freq Regulator Time 2] • $C4-02 > C4-06$ [Torque Compensation Delay Time > Motor 2 Torque Comp Delay Time] 	<ul style="list-style-type: none"> • Set $n2-02 < n2-03$. • Set $C4-02 < C4-06$.
		When $A1-02 = 0$ [Control Method Selection = V/f], you used these parameter settings: <ul style="list-style-type: none"> • $H6-01 = 3$ [Terminal RP Pulse Train Function = Speed Feedback (V/F Control)] • $H1-xx = 16$ [MFDI Function Select = Motor 2 Selection] 	Correct the parameter settings. Note: You cannot use Speed Feedback (V/F Control) with the Motor Switch function.
		When $A1-02 = 5$ [PM Open Loop Vector], you set $E5-02$ to $E5-07$ [PM Motor Parameters] = 0.	<ul style="list-style-type: none"> • Set $E5-01$ [PM Motor Code Selection] correctly as specified by the motor. • For specialized motors, refer to the motor test report and set $E5-xx$ correctly.

7.6 Parameter Setting Errors

Code	Name	Causes	Possible Solutions
		<p>When $A1-02 = 5$ to 7 [Control Methods for PM Motors], you used these parameter settings:</p> <ul style="list-style-type: none"> $E5-09 = 0.0$ [PM Back-EMF V_{peak} (mV/(rad/s)) = 0.0 mV/(rad/s)] $E5-24 = 0.0$ [PM Back-EMF L-L V_{rms} (mV/rpm) = 0.0 mV/min⁻¹] 	Set $E5-09$ or $E5-24$ to the correct value.
		When $A1-02 = 5$ to 7 , you set $E5-09 \neq 0$ and $E5-24 \neq 0$.	Set $E5-09 = 0$ or $E5-24 = 0$.
		<p>When $A1-02 = 6$ [PM Advanced Open Loop Vector], you used these parameter settings:</p> <ul style="list-style-type: none"> $n8-57 = 0$ [HFI Overlap Selection = Disabled] You set $E1-09$ [Minimum Output Frequency] < the 5% value of $E1-06$. 	Correct the parameter settings.
		<p>When $A1-02 = 6$, you set these parameters:</p> <ul style="list-style-type: none"> $n8-35 = 0$ [Initial Pole Detection Method = Pull-in] $n8-57 = 1$ [Enabled] 	Correct the parameter settings.
		<p>When $A1-02 = 8$ [EZOLV], you used these parameter settings:</p> <ul style="list-style-type: none"> $E9-01 = 1, 2$ [Motor Type Selection = Permanent Magnet (PM), Synchronous Reluctance (SynRM)] $b3-24 = 2$ [Speed Search Method Selection = Current Detection 2] 	When $E9-01 = 1$ or 2 , set $b3-24 = 1$ [Speed Estimation].
Code	Name	Causes	Possible Solutions
oPE09	PID Control Selection Fault	<p>These parameters are set at the same time:</p> <ul style="list-style-type: none"> $b5-15 \neq 0.0$ [PID Sleep Function Start Level $\neq 0.0$ Hz] $b1-03 = 2, 3$ [Stopping Method Selection = DC Injection Braking to Stop, Coast to Stop with Timer] 	<ul style="list-style-type: none"> Set $b5-15 \neq 0.0$. Set $b1-03 = 0, 1$ [Ramp to Stop, Coast to Stop].
		<p>These parameters are set at the same time:</p> <ul style="list-style-type: none"> $b5-01 = 1, 2$ [Enabled (Standard), Enabled (D = Feedforward)] $d2-02 \neq 0.0$ [Frequency Reference Lower Limit $\neq 0.0\%$] 	Correct the parameter settings.
		<p>These parameters are set at the same time:</p> <ul style="list-style-type: none"> $b5-01 = 1, 2$ [Enabled (Standard), Enabled (D = Feedforward)] $b5-11 = 1$ [PID Output Reverse Selection = Negative Output Accepted] 	Correct the parameter settings.
		<p>These parameters are set at the same time:</p> <ul style="list-style-type: none"> $b5-01 = 3, 4$ [Trim (Fref+PID Out, D = Fdbk), Trim (Fref+PID Out, D = FeedFwd)] $d2-02 \neq 0.0$ has been set. 	Correct the parameter settings.
<p>Note: The drive detects this error if the PID control function selection is incorrect. (When $b5-01 = 1$ to 4 [PID Mode Setting = PID Control Enabled])</p>			
Code	Name	Causes	Possible Solutions
oPE10	V/f Data Setting Error	<p>The parameters that set the V/f pattern do not satisfy these conditions:</p> <ul style="list-style-type: none"> For motor 1: $E1-09 \leq E1-07 < E1-06 \leq E1-11 \leq E1-04$ [Minimum Output Frequency \leq Mid Point A Frequency < Base Frequency \leq Mid Point B Frequency \leq Maximum Output Frequency] For motor 2: $E3-09 \leq E3-07 < E3-06 \leq E3-11 \leq E3-04$ [Minimum Output Frequency \leq Mid Point A Frequency < Base Frequency \leq Mid Point B Frequency \leq Maximum Output Frequency] 	Set the parameters correctly to satisfy the conditions.
Code	Name	Causes	Possible Solutions
oPE11	Carrier Frequency Setting Error	<p>These parameters are set at the same time:</p> <ul style="list-style-type: none"> $C6-05 > 6$ [Carrier Freq Proportional Gain > 6] $C6-04 > C6-03$ [Carrier Frequency Lower Limit > Carrier Frequency Upper Limit] <p>Note: When $C6-05 < 7$, $C6-04$ becomes disabled. The drive sets the carrier frequency to the value set to $C6-03$.</p>	Set $C6-02$ to $C6-05$ correctly.
		$C6-02$ to $C6-05$ settings are not in the applicable setting range.	

Code	Name	Causes	Possible Solutions
oPE13	Pulse Monitor Selection Error	<i>H6-06 = 101, 102, 105, or 116 [Terminal MP Monitor Selection = Frequency Reference, Output Frequency, Motor Speed, Output Frequency after Soft Starter] has not been set when H6-07 = 0 [Terminal MP Frequency Scaling = 0 Hz].</i>	Set H6-06 correctly.
Code	Name	Causes	Possible Solutions
oPE15	Torque Control Setting Error	More than one parameter is selecting torque control at the same time. <ul style="list-style-type: none"> <i>d5-01 = 1 [Torque Control Selection = Torque Control]</i> <i>H1-xx = 71 [MFDI Function Select = Torque Control]</i> 	Correct the parameter settings.
		Droop control and Feed Forward control are enabled at the same time that torque control is selected. <ul style="list-style-type: none"> <i>d5-01 = 1 or H1-xx = 71</i> <i>b7-01 ≠ 0.0 [Droop Control Gain ≠ 0.0%] or n5-01 = 1 [Feed Forward Control Selection = Enabled]</i> 	Correct the parameter settings.
		KEB Ride-Thru 2 (N.O., N.C.) is enabled at the same time that torque control is selected. <ul style="list-style-type: none"> <i>d5-01 = 1 or H1-xx = 71</i> <i>H1-xx = 7A [KEB Ride-Thru 2 Activate (N.C.)] or H1-xx = 7b [KEB Ride-Thru 2 Activate (N.O.)]</i> 	Correct the parameter settings.
		After a momentary power loss, drive operation will enable KEB when torque control is selected. <ul style="list-style-type: none"> <i>d5-01 = 1 or H1-xx = 71</i> <i>L2-01 = 3, 4, 5 [Power Loss Ride Through Select = Kinetic Energy Backup: L2-02, Kinetic Energy Backup: CPU Power, or Kinetic Energy Backup: DecelStop]</i> 	Correct the parameter settings.
		Optimal deceleration or overexcitation deceleration 2 is enabled at the same time that torque control is selected. <ul style="list-style-type: none"> <i>d5-01 = 1 or H1-xx = 71</i> <i>L3-04 = 2, 5 [Stall Prevention during Decel = Intelligent (Ignore Decel Ramp), Overexcitation/High Flux 2]</i> 	Correct the parameter settings.
Code	Name	Causes	Possible Solutions
oPE16	Energy Saving Constants Error	The Energy Saving parameters are not set in the applicable setting range.	Make sure that E5-xx is set correctly as specified by the motor nameplate data.
Code	Name	Causes	Possible Solutions
oPE18	Online Tuning Param Setting Err	The parameters that control online tuning are set incorrectly. In OLV control, one of these parameters was set when <i>n6-01 = 2 [Online Tuning Selection = Voltage Correction Tuning]</i> : <ul style="list-style-type: none"> <i>E2-02 [Motor Rated Slip]</i> is set to 30% of the default setting or lower. <i>E2-06 [Motor Leakage Inductance]</i> is set to 50% of the default setting or lower. <i>E2-03 = 0 [Motor No-Load Current = 0 A]</i> has been set. 	Set E2-02, E2-03, and E2-06 correctly.
Code	Name	Causes	Possible Solutions
oPE20	PG-F3 Setting Error	The value set in <i>F1-01 [Encoder 1 Pulse Count (PPR)]</i> does not agree with the number of encoder pulses.	<ul style="list-style-type: none"> Examine the F1-01 value and the number of encoder pulses. Set F1-01 correctly.
		The calculation encoder signal frequency at maximum speed is more than 20 kHz.	Decrease the value set for <i>E1-04 [Maximum Output Frequency]</i> and make sure that the output frequency of the encoder is not more than 20 kHz.

7.6 Parameter Setting Errors

Code	Name	Causes	Possible Solutions
oPE33	Digital Output Selection Error	These two parameters are set at the same time: <ul style="list-style-type: none"> $H2-60 \neq F$ [Term M1-M2 Secondary Function \neq Not Used] $H2-01 = 1xx$ [Term M1-M2 Function Selection = Inverse output of xx] 	Clear the $H2-01$ to $H2-03 = 1xx$ [Inverse output of xx] settings. Note: It is not possible to set $H2-01$ to $H2-03 = 1xx$ [Inverse output of xx] when using output functions for logic operations ($H2-60$, $H2-63$, $H2-66 \neq F$).
		These two parameters are set at the same time: <ul style="list-style-type: none"> $H2-63 \neq F$ [Term M3-M4 Secondary Function \neq Not Used] $H2-02 = 1xx$ [Term M3-M4 Function Selection = Inverse output of xx] 	
		These two parameters are set at the same time: <ul style="list-style-type: none"> $H2-66 \neq F$ [Term M5-M6 Secondary Function \neq Not Used] $H2-03 = 1xx$ [Term M5-M6 Function Selection = Inverse output of xx] 	
		These parameter pairs are set incorrectly: <ul style="list-style-type: none"> $H2-21$ [Comparator 1 Lower Limit] $>$ $H2-22$ [Comparator 1 Upper Limit] $H2-27$ [Comparator 2 Lower Limit] $>$ $H2-28$ [Comparator 2 Upper Limit] 	<ul style="list-style-type: none"> Set parameters $H2-21 \leq H2-22$. Set parameters $H2-27 \leq H2-28$.

7.7 Auto-Tuning Errors

This table gives information about errors detected during Auto-Tuning. If the drive detects an Auto-Tuning error, the keypad will show the error and the motor will coast to stop. The drive will not send notification signals for faults and alarms when Auto-Tuning errors occur.

Two types of Auto-Tuning errors are: *Endx* and *Erx*. *Endx* identifies that Auto-Tuning has successfully completed with calculation errors. Find and repair the cause of the error and do Auto-Tuning again, or set the motor parameters manually. You can use the drive in the application if you cannot find the cause of the *Endx* error.

Erx identifies that Auto-Tuning was not successful. Find and repair the cause of the error and do Auto-Tuning again.

Code	Name	Causes	Possible Solutions
End1	Excessive Rated Voltage Setting	The torque reference was more than 20% during Auto-Tuning or the no-load current that was measured after Auto-Tuning is more than 80%.	<ul style="list-style-type: none"> Make sure that the input motor nameplate data is correct. Do Auto-Tuning again and correctly set the motor nameplate data. If you can uncouple the motor and load, remove the motor from the machine and do Rotational Auto-Tuning again. If you cannot uncouple the motor and load, use the results from Auto-Tuning.
Code	Name	Causes	Possible Solutions
End2	Iron Core Saturation Coefficient	The motor nameplate data entered during Auto-Tuning is incorrect.	<ul style="list-style-type: none"> Make sure that the input motor nameplate data is correct. Do Auto-Tuning again and correctly set the motor nameplate data.
		Auto-Tuning results were not in the applicable parameter setting range, and <i>E2-07</i> or <i>E2-08</i> [<i>Motor Saturation Coefficient 2</i>] have temporary values.	<ul style="list-style-type: none"> Examine and repair damaged motor wiring. If you can uncouple the motor and load, remove the motor from the machine and do Rotational Auto-Tuning again.
Code	Name	Causes	Possible Solutions
End3	Rated Current Setting Alarm	The rated current value is incorrect.	Do Auto-Tuning again and set the correct rated current shown on the motor nameplate.
Code	Name	Causes	Possible Solutions
End4	Adjusted Slip Calculation Error	The Auto-Tuning results were not in the applicable parameter setting range.	<ul style="list-style-type: none"> Make sure the input motor nameplate data is correct. Do Rotational Auto-Tuning again and correctly set the motor nameplate data. If you cannot uncouple the motor and load, do Stationary Auto-Tuning 2.
		The motor rated slip that was measured after Stationary Auto-Tuning was 0.2 Hz or lower.	
		The motor rated slip that was measured after compensation with <i>E2-08</i> [<i>Motor Saturation Coefficient 2</i>] is not in the applicable range.	
		The secondary resistor measurement results were not in the applicable range.	
Code	Name	Causes	Possible Solutions
End5	Resistance Tuning Error	The Auto-Tuning results of the Line-to-Line Resistance were not in the applicable range.	<ul style="list-style-type: none"> Make sure that the input motor nameplate data is correct. Examine and repair damaged motor wiring.
Code	Name	Causes	Possible Solutions
End6	Leakage Inductance Alarm	The Auto-Tuning results were not in the applicable parameter setting range.	Make sure that the input motor nameplate data is correct, and do Auto-Tuning again.
		<i>A1-02</i> [<i>Control Method Selection</i>] setting is not applicable.	<ul style="list-style-type: none"> Examine the value set in <i>A1-02</i>. Make sure that the input motor nameplate data is correct, and do Auto-Tuning again.
Code	Name	Causes	Possible Solutions
End7	No-Load Current Alarm	The Auto-Tuning results of the motor no-load current value were not in the applicable range.	Examine and repair damaged motor wiring.
		Auto-Tuning results were less than 5% of the motor rated current.	Make sure that the input motor nameplate data is correct, and do Auto-Tuning again.

7.7 Auto-Tuning Errors

Code	Name	Causes	Possible Solutions
End8	HFI Alarm	<ul style="list-style-type: none"> Inductance saliency ratio (<i>E5-07/E5-06</i>) is too small. The drive cannot find the <i>n8-36 [HFI Frequency Level for L Tuning]</i> value. 	<ul style="list-style-type: none"> Set the correct value on the motor nameplate to <i>E5-xx [PM Motor Settings]</i> or do rotational/stationary Auto-Tuning. When it is necessary to set <i>n8-35 = 1 [Initial Pole Detection Method = High Frequency Injection]</i> or <i>n8-57 = 1 [HFI Overlap Selection = Enabled]</i>, make sure that there is no unusual noise in the low speed range (10% or less) and that the motor does not rotate in reverse at start. <p>Note: If the drive detects <i>End8</i>, it will automatically set <i>n8-35 = 0 [Pull-in]</i> and <i>n8-57 = 0 [Disabled]</i>. Do not change the settings unless necessary.</p>
End9	Initial Pole Detection Alarm	The drive cannot calculate the correct value for <i>n8-84 [Polarity Detection Current]</i> during High Frequency Injection Tuning.	<p>When <i>n8-35 = 1 [Initial Pole Detection Method = High Frequency Injection]</i> or <i>n8-57 = 1 [HFI Overlap Selection = Enabled]</i>, make sure that the motor does not rotate in reverse at start.</p> <p>Note: If the drive detects <i>End9</i>, it will automatically set <i>n8-35 = 0 [Pull-in]</i> and <i>n8-57 = 0 [Disabled]</i>. Do not change the settings unless necessary.</p>
Er-01	Motor Data Error	<p>The motor nameplate data entered during Auto-Tuning is incorrect.</p> <p>The combination of the motor rated power and motor rated current do not match.</p> <p>The combination of the motor rated current that was entered during Auto-Tuning and <i>E2-03 [Motor No-Load Current]</i> do not match.</p> <p>The combination of the setting values of Motor Base Frequency and Motor Base Speed do not match.</p>	<ul style="list-style-type: none"> Make sure that the motor nameplate data is correct. Do Auto-Tuning again and correctly set the motor nameplate data. Examine the combination of drive capacity and motor output. Do Auto-Tuning again, and correctly set the motor rated power and motor rated current. Examine the motor rated current and the no-load current. Set <i>E2-03</i> correctly. Do Auto-Tuning again, and correctly set the motor rated current. <p>Do Auto-Tuning again, and correctly set the Motor Base Frequency and Motor Base Speed.</p>
Er-02	Drive in an Alarm State	<p>The motor nameplate data entered during Auto-Tuning is incorrect.</p> <p>You did Auto-Tuning while the drive had a minor fault or alarm.</p> <p>There is a defective motor cable or cable connection.</p> <p>The load is too large.</p> <p>The drive detected a minor fault during Auto-Tuning.</p>	<ul style="list-style-type: none"> Make sure that the motor nameplate data entered in Auto-Tuning is correct. Do Auto-Tuning again and correctly set the motor nameplate data. <p>Clear the minor fault or alarm and do Auto-Tuning again.</p> <p>Examine and repair motor wiring.</p> <ul style="list-style-type: none"> Decrease the load. Examine the machine area to see if, for example, the motor shaft is locked. <ol style="list-style-type: none"> Stop Auto-Tuning. Examine the minor fault code and remove the cause of the problem. Do Auto-Tuning again.
Er-03	STOP Button was Pressed	During Auto-Tuning,  was pushed.	Auto-Tuning did not complete correctly. Do Auto-Tuning again.
Er-04	Line-to-Line Resistance Error	<p>The Auto-Tuning results were not in the applicable parameter setting range.</p> <p>Auto-Tuning did not complete in a pre-set length of time.</p> <p>There is a defective motor cable or cable connection.</p> <p>The motor nameplate data entered during Auto-Tuning is incorrect.</p>	<ul style="list-style-type: none"> Examine and repair motor wiring. Disconnect the machine from the motor and do Rotational Auto-Tuning again. Make sure that the input motor nameplate data is correct. Do Auto-Tuning again and correctly set the motor nameplate data.

Code	Name	Causes	Possible Solutions
Er-05	No-Load Current Error	The Auto-Tuning results were not in the applicable parameter setting range.	<ul style="list-style-type: none"> Examine and repair motor wiring. Disconnect the machine from the motor and do Rotational Auto-Tuning again.
		Auto-Tuning did not complete in a pre-set length of time.	
		The motor nameplate data entered during Auto-Tuning is incorrect.	<ul style="list-style-type: none"> Make sure that the input motor nameplate data is correct. Do Auto-Tuning again and correctly set the motor nameplate data.
		Rotational Auto-Tuning was done with a load that was more than 30% of the rating connected to the motor.	<ul style="list-style-type: none"> Disconnect the machine from the motor and do Rotational Auto-Tuning again. If you cannot uncouple the motor and load, make sure that the load is less than 30% of the motor rating. If a mechanical brake is installed in the motor, release the brake during Rotational Auto-Tuning.
Code	Name	Causes	Possible Solutions
Er-08	Rated Slip Error	The motor nameplate data entered during Auto-Tuning is incorrect.	<ul style="list-style-type: none"> Make sure that the input motor nameplate data is correct. Do Auto-Tuning again and correctly set the motor nameplate data.
		Auto-Tuning did not complete in a pre-set length of time.	<ul style="list-style-type: none"> Examine and repair the motor wiring. If the motor and machine are connected during Rotational Auto-Tuning, decouple the motor from the machinery.
		The Auto-Tuning results were not in the applicable parameter setting range.	
		Rotational Auto-Tuning was done with a load that was more than 30% of the rating connected to the motor.	<ul style="list-style-type: none"> Disconnect the machine from the motor and do Rotational Auto-Tuning again. If you cannot uncouple the motor and load, make sure that the load is less than 30% of the motor rating. If a mechanical brake is installed in the motor, release the brake during Rotational Auto-Tuning.
Code	Name	Causes	Possible Solutions
Er-09	Acceleration Error	The motor did not accelerate for the specified acceleration time.	<ol style="list-style-type: none"> Increase the value set in <i>C1-01 [Acceleration Time 1]</i>. Disconnect the machine from the motor and do Rotational Auto-Tuning again.
		The value of <i>L7-01</i> or <i>L7-02 [Forward/Reverse Torque Limit]</i> is small.	Increase the value set in <i>L7-01</i> or <i>L7-02</i> .
		Rotational Auto-Tuning was done with a load that was more than 30% of the rating connected to the motor.	<ul style="list-style-type: none"> Disconnect the machine from the motor and do Rotational Auto-Tuning again. If you cannot uncouple the motor and load, make sure that the load is less than 30% of the motor rating. If a mechanical brake is installed in the motor, release the brake during Rotational Auto-Tuning.
Code	Name	Causes	Possible Solutions
Er-10	Motor Direction Error	There is defective drive and motor wiring.	Examine and repair motor wiring.
		There is defective drive and encoder wiring.	Examine and repair the wiring to the encoder.
		The direction of the motor and the setting of <i>F1-05 [PG 1 Rotation Selection]</i> are opposite.	Set <i>F1-05</i> correctly.
		The machine pulled the motor to rotate in the opposite direction.	Disconnect the machine from the motor and do Rotational Auto-Tuning again.
		When the torque reference is 100% or higher, the sign of the speed reference was opposite of the detected speed.	
Code	Name	Causes	Possible Solutions
Er-11	Motor Speed Error	The torque reference during acceleration is too high (100%).	<ul style="list-style-type: none"> Increase the value set in <i>C1-01 [Acceleration Time 1]</i>. Disconnect the machine from the motor and do Rotational Auto-Tuning again.
Code	Name	Causes	Possible Solutions
Er-12	Current Detection Error	There is a phase loss in the drive input power. (U/T1, V/T2, W/T3)	Examine and repair motor wiring.
		The current exceeded the current rating of the drive.	<ul style="list-style-type: none"> Check the motor wiring for any short circuits between the wires. Check and turn ON any magnetic contactors used between motors. Replace the control board or the drive. For information about replacing the control board, contact Yaskawa or your nearest sales representative.
		The output current is too low.	

7.7 Auto-Tuning Errors

Code	Name	Causes	Possible Solutions
		You tried Auto-Tuning without a motor connected to the drive.	Connect the motor and do Auto-Tuning.
		There was a current detection signal error.	Replace the control board or the drive. For information about replacing the control board, contact Yaskawa or your nearest sales representative.
Code	Name	Causes	Possible Solutions
Er-13	Leakage Inductance Alarm	The motor rated current value is incorrect.	Correctly set the rated current indicated on the motor nameplate and perform Auto-Tuning again.
		The drive could not complete tuning for leakage inductance in fewer than 300 seconds.	Examine and repair motor wiring.
Code	Name	Causes	Possible Solutions
Er-14	Motor Speed Error 2	The motor speed was more than two times the amplitude of speed reference during Inertia Tuning.	Decrease the value set in <i>C5-01 [ASR Proportional Gain 1]</i> .
Code	Name	Causes	Possible Solutions
Er-15	Torque Saturation Error	During Inertia Tuning, the output torque was more than the value set in <i>L7-01 to L7-04 [Torque Limit]</i> .	<ul style="list-style-type: none"> • Increase the value set in <i>L7-01 to L7-04 [Torque Limit]</i> as much as possible. • Decrease the values set for the frequency and amplitude of the test signals used when doing inertia tuning. First, decrease the test signal amplitude, and then do Inertia Tuning. If the error continues, decrease the test signal frequency and do Inertia Tuning again.
Code	Name	Causes	Possible Solutions
Er-16	Inertia ID Error	The inertia found by the drive was too small or too large during Inertia Tuning (10% or less, or 50000% or more).	<ul style="list-style-type: none"> • Decrease the values set for the frequency and amplitude of the test signals used when doing inertia tuning. First, decrease the test signal amplitude, and then do Inertia Tuning. If the error continues, decrease the test signal frequency and do Inertia Tuning again. • Correctly set the motor inertia as specified by the motor, and do Inertia Tuning again.
Code	Name	Causes	Possible Solutions
Er-17	Reverse Prohibited Error	<p><i>b1-04 = 1 [Reverse Operation Selection = Reverse disabled]</i> has been set.</p> <p>Note: You cannot do Inertia Tuning if the drive cannot rotate the motor in reverse.</p>	<ol style="list-style-type: none"> 1. Enable reverse in the target machine. 2. Set <i>b1-04 = 0 [Reverse enabled]</i>. 3. Do Inertia Tuning again.
Code	Name	Causes	Possible Solutions
Er-18	Back EMF Error	The result of the induced voltage tuning was not in the applicable range.	<ol style="list-style-type: none"> 1. Make sure that the input motor nameplate data is correct. 2. Do Auto-Tuning again and correctly set the motor nameplate data.
Code	Name	Causes	Possible Solutions
Er-19	PM Inductance Error	The Auto-Tuning results of the PM motor inductance were not in the applicable range.	<ol style="list-style-type: none"> 1. Make sure that the input motor nameplate data is correct. 2. Do Auto-Tuning again and correctly set the motor nameplate data.
Code	Name	Causes	Possible Solutions
Er-20	Stator Resistance Error	The Auto-Tuning results of the PM Motor Stator Resistance were not in the applicable range.	<ol style="list-style-type: none"> 1. Make sure that the input motor nameplate data is correct. 2. Do Auto-Tuning again and correctly set the motor nameplate data.
Code	Name	Causes	Possible Solutions
Er-21	Z Pulse Correction Error	The motor is wired incorrectly.	<ol style="list-style-type: none"> 1. Repair motor and encoder wiring errors. 2. Do Z Pulse Offset Tuning again.
		The encoder is wired incorrectly.	<ol style="list-style-type: none"> 1. Wait for the motor to fully stop. 2. Do Z Pulse Offset Tuning again.
		You did Auto-Tuning on a coasting motor.	<ol style="list-style-type: none"> 1. Wait for the motor to fully stop. 2. Do Z Pulse Offset Tuning again.
		The setting for the direction of the encoder motor rotation is incorrect.	<ol style="list-style-type: none"> 1. Set the direction of motor rotation of the encoder in <i>F1-05 [Encoder 1 Rotation Selection]</i> correctly. 2. Do Z Pulse Offset Tuning again.
		The number of encoder pulses is incorrect.	<ol style="list-style-type: none"> 1. Set the number of encoder pulses in <i>F1-01 [Encoder 1 Pulse Count (PPR)]</i> correctly. 2. Do Z Pulse Offset Tuning again.
		The motor Inertia is too large.	Increase the value set in <i>n8-02 [Pole Alignment Current Level]</i> .

Code	Name	Causes	Possible Solutions
		Parameter <i>b1-04 = 1</i> [<i>Reverse Operation Selection = Reverse Disabled</i>] and you did Z Pulse Offset Tuning.	<ul style="list-style-type: none"> If the machine prevents reverse rotation, disconnect the motor from the machinery, set <i>b1-04 = 0</i> [<i>Reverse Enabled</i>], then do Z Pulse Offset Tuning. When tuning is complete, set <i>b1-04 = 1</i> [<i>Reverse Disabled</i>]. If the machine does not prevent reverse rotation, set <i>b1-04 = 0</i> and do Z Pulse Offset Tuning.
		The motor vibrates during tuning.	<ul style="list-style-type: none"> Increase the values set in <i>n8-03</i> [<i>Pole Position Detection Time</i>] and <i>n8-04</i> [<i>Pole Alignment Time</i>]. Decrease the value set in <i>n8-02</i> [<i>Pole Alignment Current Level</i>].
		The encoder is damaged.	<ul style="list-style-type: none"> Examine the signal output from the encoder. Replace the encoder.
Code	Name	Causes	Possible Solutions
Er-25	HighFreq Inject Param Tuning Err	The motor data is incorrect.	<p>Do Stationary Auto-Tuning again.</p> <p>Note: If the drive detects <i>Er-25</i> after doing Stationary Auto-Tuning, the motor may not be able to use high frequency injection control. Contact Yaskawa or your nearest sales representative for more information.</p>

7.8 Backup Function Operating Mode Display and Errors

◆ Operating Mode Display

When you use the backup function from the LCD keypad, the keypad shows messages according to the current operation. These indicators do not show that an error has occurred.

Keypad Display	Name	Display	Status
Drive and Keypad mismatch. Should the parameters be restored?	Detection of inconsistency between the drive and keypad	Normally displayed	The drive detected the connection of a keypad from a different drive. Select [Yes] to copy parameters backed up in the keypad to the connected drive.
Restore Restore from keypad	Restoring parameters	Flashing	The parameters stored in the keypad have been restored to the drive.
End	Backup/restore/verify operation ended normally	Normally displayed	The parameter backup, restore, or verify operation ended normally.
Backup Backup from Drive	Backing up parameters	Flashing	The parameters stored in the drive are being backed up to the keypad.
Verify Keypad & Drive	Verifying parameters	Flashing	The parameter settings stored in the keypad and the parameter settings in the drive match or are being compared.

◆ Backup Function Runtime Errors

When an error occurs, the keypad shows a code to identify the error.

The table in this section show the error codes. Refer to these tables to remove the cause of the errors.

Note:

Push any key on the keypad to clear an error.

Code	Name	Causes	Possible Solutions
CPEr	Control Mode Mismatch	The keypad setting and drive setting for <i>A1-02 [Control Method Selection]</i> do not agree.	<ol style="list-style-type: none"> Set <i>A1-02</i> on the drive to the same value that is on the keypad. Restore the parameters.
CPyE	Error Writing Data	Parameter restore did not end correctly.	Restore the parameters.
CSEr	Control Mode Mismatch	The keypad is broken.	Replace the keypad.
dFPS	Drive Model Mismatch	You tried to restore parameters to a different drive model than the one that you backed up.	<ol style="list-style-type: none"> Examine the drive model that you used to back up the parameters. Restore the parameters.
iFEr	Keypad Communication Error	There was a communications error between the keypad and the drive.	Examine the connector or cable connection.
ndAT	Error Received Data	<p>The parameter settings for model and specifications (power supply voltage and capacity) are different between the keypad and the drive.</p> <p>The parameters are not stored in the keypad.</p>	<ol style="list-style-type: none"> Make sure that drive model and the value set in <i>o2-04 [Drive Model (KVA) Selection]</i> agree. Restore the parameters. Connect a keypad that has the correct parameters. Restore the parameters.
PWEr	DWEZ Password Mismatch	The password set in the backup operation with <i>qx-xx [DriveWorksEZ Parameters]</i> and <i>rx-xx [DriveWorksEZ Connections]</i> is incorrect.	Set the DWEZ PC software password supplied by Yaskawa for the DWEZ program user ID downloaded to the drive.
<p>Note: <i>U8-11 and U8-12 [DWEZ Versions 1 and 2]</i> show the user ID of the DWEZ program.</p>			

7.8 Backup Function Operating Mode Display and Errors

Code	Name	Causes	Possible Solutions
rdEr	Error Reading Data	You tried to back up the data when <i>o3-02 = 0 [Copy Allowed Selection = Disabled]</i> .	Set <i>o3-02 = 1 [Enabled]</i> and back up again.
Code	Name	Causes	Possible Solutions
vAEr	Voltage Class, Capacity Mismatch	The power supply specifications or drive capacity parameter settings are different between the keypad and the drive.	<ol style="list-style-type: none"> 1. Make sure that drive model and the value set in <i>o2-04 [Drive Model (KVA) Selection]</i> agree. 2. Restore the parameters.
Code	Name	Causes	Possible Solutions
vFyE	Parameters do not Match	The parameters that are backed up in the keypad and the parameters in the drive are not the same.	<ol style="list-style-type: none"> 1. Restore or backup the parameter again. 2. Verify the parameters.

7.9 Diagnosing and Resetting Faults

When a fault occurs and the drive stops, do the procedures in this section to remove the cause of the fault, then re-energize the drive.

◆ Fault Occurs Without Power Loss

WARNING! Crush Hazard. Wear eye protection when you do work on the drive. If you do not use correct safety equipment, it can cause serious injury or death.

WARNING! Electrical Shock Hazard. After the drive blows a fuse or trips a GFCI, do not immediately energize the drive or operate peripheral devices. Wait for the time specified on the warning label at a minimum and make sure that all indicators are OFF. Then check the wiring and peripheral device ratings to find the cause of the problem. If you do not know the cause of the problem, contact Yaskawa before you energize the drive or peripheral devices. If you do not fix the problem before you operate the drive or peripheral devices, it can cause serious injury or death.

1. Supply power to the control circuit from the external 24 V input.
2. Use monitor parameters $U2-xx$ [*Fault Trace*] to show the fault code and data about the operating status of the drive immediately before the fault occurred.
3. Use the information in the Troubleshooting tables to remove the fault.

Note:

1. To find the faults that were triggered, check the fault history in $U2-02$ [*Previous Fault*]. To find information about drive status (such as frequency, current, and voltage) when the faults were triggered, check $U2-03$ to $U2-20$.
2. If the fault display stays after you re-energize the drive, remove the cause of the fault and reset.

◆ Fault Occurs Without Power Loss

1. Examine the fault code shown on the keypad.
2. Use the information in the Troubleshooting tables to remove the fault.
3. Do a fault reset.

◆ Fault Reset

If a fault occurs, you must remove the cause of the fault and re-energize the drive. [Table 7.3](#) lists the different methods to reset the drive after a fault.

Table 7.3 Fault Reset Methods

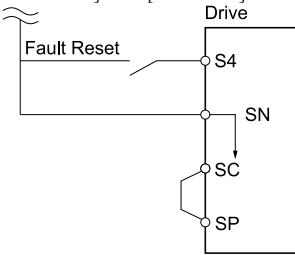
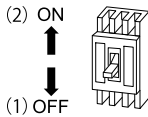
Methods	Description
Method 1	While the keypad is showing the fault or alarm code, push F1 (Reset) or  on the keypad.
Method 2	<p>Switch ON the MFDI terminal set to $H1-xx = 14$ [<i>MFDI Function Select = Fault Reset</i>].</p> <p>Note: The default setting for $H1-04$ [<i>Terminal S4 Function Selection</i>] is 14 [<i>Fault Reset</i>].</p> 
Method 3	<ol style="list-style-type: none"> 1. De-energize the drive main circuit power supply. 2. Energize the drive again after the keypad display goes out. 

Note:

If the drive receives a Run command from a communication option or control circuit terminal, the drive will not reset the fault. Remove the Run command then try to clear the fault. If you do a fault reset when the drive has a Run command, the keypad will show minor fault *CrST* [*Remove RUN Command to Reset*].

7.10 Troubleshooting Without Fault Display

Note:

Make sure that you use a keypad with FLASH number 1004 or later. Keypads with FLASH numbers 1003 and earlier will not show characters correctly.

If the drive or motor operate incorrectly, but the keypad does not show a fault or error code, refer to the items this section.

- Motor hunting and oscillation
- Unsatisfactory motor torque
- Unsatisfactory speed precision
- Unsatisfactory motor torque and speed response
- Motor noise

◆ Typical Problems







Symptom	Reference
The Parameter Settings Will Not Change	362
The Motor Does Not Rotate After Entering Run Command	363
The Motor Rotates in the Opposite Direction from the Run Command	364
The Motor Rotates in Only One Direction	364
The Motor Is Too Hot	364
The Correct Auto-Tuning Mode Is Not Available	365
The Motor Stalls during Acceleration or Accel/Decel Time Is Too Long	365
The Drive Frequency Reference Is Different than the Controller Frequency Reference Command	366
The Motor Speed Is Not Stable When Using a PM Motor	366
There Is Too Much Motor Oscillation and the Rotation Is Irregular	366
Deceleration Takes Longer Than Expected When Dynamic Braking Is Enabled	366
There Is Audible Noise from the Drive or Motor Cables When the Drive Is Energized	367
The Ground Fault Circuit Interrupter (GFCI) Trips During Run	367
Motor Rotation Causes Unexpected Audible Noise from Connected Machinery	367
Motor Rotation Causes Oscillation or Hunting	367
PID Output Fault	368
The Starting Torque Is Not Sufficient	368
The Motor Rotates after the Drive Output Is Shut Off	368
The Output Frequency Is Lower Than the Frequency Reference	368
The Motor Is Making an Audible Noise	369
The Motor Will Not Restart after a Loss of Power	369

◆ The Parameter Settings Will Not Change

Causes	Possible Solutions
The drive is operating the motor (the drive is in Drive Mode).	Stop the drive and change to Programming Mode.
Parameter $A1-01 = 0$ [Access Level Selection = Operation Only].	Set $A1-01 = 2$ [Access Level Selection = Advanced Level] or $A1-01 = 3$ [Expert Level].
Parameter $H1-xx = 1B$ [MFDI Function Select = Programming Lockout].	Turn ON the terminals to which $H1-xx = 1B$ is set, and then change the parameters.

Causes	Possible Solutions
An incorrect password was entered in A1-04 [Password].	<ul style="list-style-type: none"> Enter the correct password to A1-04 again. If you forgot the password, set the password again with A1-04 and A1-05 [Password Setting]. <p>Note: If the password is set, it will not be possible to change these parameters until the password matches:</p> <ul style="list-style-type: none"> A1-01 [Access Level Selection] A1-02 [Control Method Selection] A1-03 [Initialize Parameters] A1-06 [Application Preset] A1-07 [DriveWorksEZ Function Selection] A2-01 to A2-32 [User Parameter 1 to User Parameter 32]
The drive detected Uv [Undervoltage].	<ul style="list-style-type: none"> View U1-07 [DC Bus Voltage] to see the power supply voltage. Examine the main circuit wiring.

◆ The Motor Does Not Rotate After Entering Run Command

Causes	Possible Solutions
The drive is not in Drive Mode.	<ol style="list-style-type: none"> Make sure that the keypad shows [Rdy]. If the keypad does not show [Rdy], go back to the Home screen.
The drive stopped,  was pushed, and changed the Run command source to the keypad.	<p>Do one of these two:</p> <ul style="list-style-type: none"> Push . Re-energize the drive. <p>Note: Set o2-01 = 0 [LO/RE Key Function Selection = Disabled] to prevent changing the Run command source with .</p>
Auto-Tuning completed.	<p>Go back to the Home screen on the keypad.</p> <p>Note: When Auto-Tuning completes, the drive changes to Programming Mode. The drive will not accept a Run command unless the drive is in Drive Mode.</p>
The drive received a fast stop command.	Turn off the fast stop input signal.
The settings for the source that supplies the Run command are incorrect.	Set b1-02 [Run Command Selection 1] correctly.
The frequency reference source is set incorrectly.	Set b1-01 [Frequency Reference Selection 1] correctly.
There is defective wiring in the control circuit terminals.	<ul style="list-style-type: none"> Correctly wire the drive control circuit terminals. View U1-10 [Input Terminal Status] for input terminal status.
The settings for voltage input and current input of the master frequency reference are incorrect.	<p>Examine these analog input terminal signal level settings:</p> <ul style="list-style-type: none"> Terminal A1: DIP switch S1-1 and H3-01 [Terminal A1 Signal Level Select] Terminal A2: DIP switch S1-2 and H3-09 [Terminal A2 Signal Level Select] Terminal A3: DIP switch S4, S1-3 and H3-05 [Terminal A3 Signal Level Select]
The selection for the sinking/sourcing mode and the internal/external power supply is incorrect.	<ul style="list-style-type: none"> For sinking mode, close the circuit between terminals SC-SP with a wire jumper. For sourcing mode, close the circuit between terminals SC-SN with a wire jumper. For external power supply, remove the wire jumper.
The frequency reference is too low.	<ul style="list-style-type: none"> View U1-01 [Freq Reference]. Increase the frequency reference to a value higher than E1-09 [Minimum Output Frequency].
The MFAI setting is incorrect.	<ul style="list-style-type: none"> Make sure that the functions set to the MFAI are correct. The frequency reference is 0 when H3-02, H3-10, H3-06 = 1 [MFAI Function Select = Frequency Gain] and voltage (current) is not input. View U1-13 to U1-15 [Terminal A1, A2, A3 Input Voltage] to see if the analog input values set to terminals A1, A2, and A3 are applicable.
 was pushed.	<p>Turn the Run command OFF then ON from an external input.</p> <p>Note: When you push  during operation, the drive will ramp to stop. Set o2-02 = 0 [STOP Key Function Selection = Disabled] to disable the  function.</p>
The 2-wire sequence and 3-wire sequence are set incorrectly.	<ul style="list-style-type: none"> Set one of the parameters H1-03 to H1-08 [Terminals S3 to S8 Function Select] to 0 [3-Wire Sequence] to enable the 3-wire sequence. If a 2-wire sequence is necessary, make sure that H1-03 to H1-08 ≠ 0.

◆ The Motor Rotates in the Opposite Direction from the Run Command

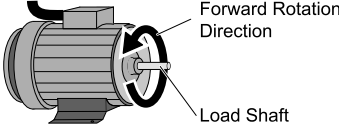
Causes	Possible Solutions
The phase wiring between the drive and motor is incorrect.	<ul style="list-style-type: none"> Examine the wiring between the drive and motor. Connect drive output terminals U/T1, V/T2, and W/T3 in the correct sequence to agree with motor terminals U, V, and W. Switch two motor cables U, V, and W to reverse motor direction.
The forward direction for the motor is set incorrectly.	<ul style="list-style-type: none"> Connect drive output terminals U/T1, V/T2, and W/T3 in the correct sequence to agree with motor terminals U, V, and W. Switch two motor cables U, V, and W to reverse motor direction. <div style="text-align: center;">  <p>Figure 7.1 Forward Rotating Motor</p> <p>Note:</p> <ul style="list-style-type: none"> For Yaskawa motors, the forward direction is counterclockwise when looking from the motor shaft side. Refer to the motor specifications, and make sure that the forward rotation direction is correct for the application. The forward rotation direction of motors can be different for different motor manufacturers and types. </div>
The signal connections for forward run and reverse run on the drive control circuit terminals and control panel side are incorrect.	Correctly wire the control circuit.
The motor is running at almost 0 Hz and the Speed Search estimated the speed to be in the opposite direction.	Set $b3-14 = 0$ [<i>Bi-directional Speed Search = Disabled</i>], then the drive will only do speed search in the specified direction.

◆ The Motor Rotates in Only One Direction

Causes	Possible Solutions
The drive will not let the motor rotate in reverse.	Set $b1-04 = 0$ [<i>Reverse Operation Selection = Reverse Enabled</i>].
The drive did not receive a Reverse run signal and 3-Wire sequence is selected.	Turn ON the terminals to which $H1-xx = 0$ [<i>3-Wire Sequence</i>] is set, and then enable reverse operation.

◆ The Motor Is Too Hot

Causes	Possible Solutions
The load is too heavy.	<ul style="list-style-type: none"> Decrease the load. Increase the acceleration and deceleration times. Examine the values set in $L1-01$ [<i>Motor Overload (oL1) Protection</i>], $L1-02$ [<i>Motor Overload Protection Time</i>], and $E2-01$ [<i>Motor Rated Current (FLA)</i>]. Use a larger motor. <p>Note: The motor also has a short-term overload rating. Examine this rating carefully before setting drive parameters.</p>
The motor is running continuously at a very low speed.	<ul style="list-style-type: none"> Change the run speed. Use a drive-dedicated motor.
The drive is operating in a vector control mode, but Auto-Tuning has not been done.	<ul style="list-style-type: none"> Do Auto-Tuning. Calculate motor parameter and set motor parameters. Set $A1-02 = 0$ [<i>Control Method Selection = V/f Control</i>].
The voltage insulation between motor phases is not sufficient.	<ul style="list-style-type: none"> Use a motor with a voltage tolerance that is higher than the maximum voltage surge. Use a drive-dedicated motor that is rated for use with AC drives for applications that use a motor on drives rated higher than 400 V class. Install an AC reactor on the output side of the drive and set $C6-02 = 1$ [<i>Carrier Frequency Selection = 2.0 kHz</i>]. <p>Note: When the motor is connected to the drive output terminals U/T1, V/T2, and W/T3, surges occur between the drive switching and the motor coils. These surges can be three times the drive input power supply voltage (600 V for a 200 V class drive, 1200 V for a 400 V class drive).</p>
The air around the motor is too hot.	<ul style="list-style-type: none"> Measure the ambient temperature. Decrease the temperature in the area until it is in the specified temperature range.
The motor fan stopped or is clogged.	<ul style="list-style-type: none"> Clean the motor fan. Make the drive environment better.

◆ The Correct Auto-Tuning Mode Is Not Available

Causes	Possible Solutions
The desired Auto-Tuning mode is not available for the selected control mode.	Change the motor control method with parameter <i>A1-02</i> [Control Method Selection].

◆ The Motor Stalls during Acceleration or Accel/Decel Time Is Too Long

Causes	Possible Solutions
The drive and motor system reached the torque limit or current suppression will not let the drive accelerate.	<ul style="list-style-type: none"> Decrease the load. Use a larger motor. <p>Note: Although the drive has a Stall Prevention function and a Torque Compensation Limit function, accelerating too fast or trying to drive a load that is too large can exceed the limits of the motor.</p>
Torque limit is set incorrectly.	Set the torque limit correctly.
The acceleration time setting is too short.	Check the values set in <i>C1-01</i> , <i>C1-03</i> , <i>C1-05</i> , or <i>C1-07</i> [Acceleration Time] and set them to applicable values.
The load is too heavy.	<ul style="list-style-type: none"> Increase the acceleration time. Examine the mechanical brake and make sure that it is fully releasing. Decrease the load to make sure that the output current stays less than the motor rated current. Use a larger motor. <p>Note: • In extruder and mixer applications, the load can increase as the temperature decreases. • Although the drive has a Stall Prevention function and a Torque Compensation Limit function, accelerating too fast or trying to drive a load that is too large can exceed the limits of the motor.</p>
The frequency reference is low.	<ul style="list-style-type: none"> Examine <i>E1-04</i> [Maximum Output Frequency] and increase the setting if it is set too low. Examine <i>U1-01</i> [Frequency Reference] for the correct frequency reference. Examine the multi-function input terminals to see if a frequency reference signal switch has been set. Examine the low gain level set in <i>H3-03</i>, <i>H3-11</i>, <i>H3-07</i> [Terminal A1, A2, A3 Gain Setting] if you use MFAI.
The frequency reference is set incorrectly.	<p>When <i>H3-02</i>, <i>H3-10</i>, <i>H3-06</i> = 1 [MFAI Function Select = Frequency Gain] are set, see if voltage (current) has been set.</p> <ul style="list-style-type: none"> Check the values set in <i>H3-02</i>, <i>H3-10</i>, and <i>H3-06</i>. Use <i>U1-13</i> to <i>U1-15</i> [Terminal A1, A2, A3 Input Voltage] to make sure that the analog input values set to terminals A1, A2, and A3 are applicable.
The motor characteristics and drive parameter settings are not compatible.	<ul style="list-style-type: none"> Set the correct V/f pattern to agree with the characteristics of the motor. Examine the V/f pattern set in <i>E1-03</i> [V/f Pattern Selection]. Perform Rotational Auto-Tuning.
The drive is operating in vector control mode, but Auto-Tuning is not completed.	<ul style="list-style-type: none"> Do Auto-Tuning. Calculate motor data and reset motor parameters. Set <i>A1-02</i> = 0 [Control Method Selection = V/f Control].
Parameter <i>A1-02</i> = 4 [Control Method Selection = Advanced Open Loop Vector] and the speed estimation response is too slow.	Increase the value set in <i>n4-65</i> [Flux Estimate Response@High Freq] in 0.1-unit increments.
The Stall Prevention level during acceleration setting is too low.	<p>Increase the value set in <i>L3-02</i> [Stall Prevent Level during Accel].</p> <p>Note: If the <i>L3-02</i> value is too low, the acceleration time can be unsatisfactorily long.</p>
The Stall Prevention level during run setting is too low.	<p>Increase the value set in <i>L3-06</i> [Stall Prevent Level during Run].</p> <p>Note: If the <i>L3-06</i> value is too low, speed will decrease while the drive outputs torque.</p>
Drive reached the limitations of the V/f motor control method.	<ul style="list-style-type: none"> When the motor cable is longer than 50 m (164 ft.), do Auto-Tuning for line-to-line resistance. Set the V/f pattern to "High Starting Torque". Use a Vector Control method. <p>Note: V/f control method does not provide high torque at low speeds.</p>

◆ The Drive Frequency Reference Is Different than the Controller Frequency Reference Command

Causes	Possible Solutions
The analog input gain and bias for the frequency reference input are set incorrectly.	Examine the gain and bias settings for the analog inputs that set the frequency reference. <ul style="list-style-type: none"> Terminal A1: H3-03 [Terminal A1 Gain Setting], H3-04 [Terminal A1 Bias Setting] Terminal A2: H3-11 [Terminal A2 Gain Setting], H3-12 [Terminal A2 Bias Setting] Terminal A3: H3-07 [Terminal A3 Gain Setting], H3-08 [Terminal A3 Bias Setting]
The drive is receiving frequency bias signals from analog input terminals A1 to A3 and the sum of all signals makes the frequency reference.	<ul style="list-style-type: none"> Examine parameters H3-02, H3-10, H3-06 [MFAI Function Select]. If two or more of these parameters are set to 0, change the settings. Use U1-13 to U1-15 [Terminal A1, A2, A3 Input Voltage] to make sure that the analog input values set to terminals A1, A2, and A3 are applicable.
The motor rotates faster than the frequency reference at low speed.	Reduce the value set in n4-70 [Speed Command Comp @ Low Freq].
PID control is enabled.	If PID control is not necessary, set b5-01 = 0 [PID Mode Setting = Disabled]. <p>Note: When PID control is enabled, the drive adjusts the output frequency as specified by the target value. The drive will only accelerate to the maximum output frequency set in E1-04 [Maximum Output Frequency] while PID control is active.</p>

◆ The Motor Speed Is Not Stable When Using a PM Motor

Causes	Possible Solutions
E5-01 [PM Motor Code Selection] is set incorrectly.	Refer to "Motor Performance Fine-Tuning" in the technical manual.
The drive is operating the motor at more than the specified speed control range.	Examine the speed control range and adjust the speed.
The motor is hunting.	Adjust these parameters to have the largest effect: <ul style="list-style-type: none"> n8-55 [Motor to Load Inertia Ratio] n8-45 [Speed Feedback Detection Gain] C4-02 [Torque Compensation Delay Time]
Hunting occurs at start.	Increase the value set in C2-01 [S-Curve Time @ Start of Accel].
Too much current is flowing through the drive.	Set E5-01 [PM Motor Code Selection] correctly as specified by the motor. For special-purpose motors, enter the correct value to E5-xx as specified by the motor test report.
Operation is not stable when n8-57 = 1 [HFI Overlap Selection = Enabled].	<ul style="list-style-type: none"> Do High Frequency Injection Auto-Tuning. Decrease the value set in n8-41 [HFI P Gain] in increments of 0.5. <p>Note: Set n8-41 > 0.0 for IPM motors.</p>

◆ There Is Too Much Motor Oscillation and the Rotation Is Irregular

Causes	Possible Solutions
Unsatisfactory balance of motor phases.	<ul style="list-style-type: none"> Make sure that the drive input power voltage supplies stable power. Set L8-05 = 0 [Input Phase Loss Protect Select = Disabled].
The motor is hunting.	<ul style="list-style-type: none"> Set n1-01 = 1 [Hunting Prevention Selection = Enabled]. Increase the value of n2-01 [SpdFeedbackDetectCtr (AFR) Gain] or n2-02 [SpdFeedbackDetCtr (AFR)TimeConst1].

◆ Deceleration Takes Longer Than Expected When Dynamic Braking Is Enabled

Causes	Possible Solutions
The stall prevention during deceleration setting is incorrect.	<ul style="list-style-type: none"> Examine the setting for L3-04 [Decel Stall Prevention Selection]. When the drive has a dynamic braking option installed, set L3-04 = 0 [Disabled]. If the drive detects ov [Overvoltage], set L3-04 = 3 [General Purpose w/ DB resistor].
The deceleration time setting is too long.	Set C1-02, C1-04, C1-06, or C1-08 [Deceleration Times] to applicable values.
The motor torque is not sufficient.	Use a larger motor. <p>Note: If these items are correct, the demand on the motor is more than the motor capacity:</p> <ul style="list-style-type: none"> Parameter settings are correct. The drive does not detect ov [Overvoltage].

Causes	Possible Solutions
The drive and motor system reached the torque limit.	<ul style="list-style-type: none"> Examine the values set in L7-01 to L7-04 [Torque Limit] and increase them if necessary. <p>Note: If the torque limit is enabled, deceleration time can increase because the drive cannot output more torque than the limit.</p> <ul style="list-style-type: none"> If H3-02, H3-10, H3-06 = 10, 11, 12, 15 [MFAI Function Select = Torque Limit] has been set, examine the settings for the MFAls. <ul style="list-style-type: none"> Examine the values set in H3-02, H3-10, and H3-06. Use U1-13 to U1-15 [Terminal A1, A2, A3 Input Voltage] to make sure that the analog input values set to terminals A1, A2, and A3 are applicable.
The load is more than the internal torque limit as specified by the drive rated current.	Replace the drive with a larger capacity model.

◆ There Is Audible Noise from the Drive or Motor Cables When the Drive Is Energized

Causes	Possible Solutions
The relay switching in the drive is making too much noise.	<ul style="list-style-type: none"> Use C6-02 [Carrier Frequency Selection] to decrease the carrier frequency. Connect a noise filter to the input side of the drive power supply. Connect a noise filter to the output side of the drive. Isolate the control circuit wiring from the main circuit wiring. Use a metal cable gland to wire the drive. Shield the periphery of the drive with metal. Make sure that the drive and motor are grounded correctly. Make sure that ground faults have not occurred in the wiring or motor.

◆ The Ground Fault Circuit Interrupter (GFCI) Trips During Run

Causes	Possible Solutions
There is too much leakage current from the drive.	<ul style="list-style-type: none"> Increase the GFCI sensitivity or use GFCI with a higher threshold. Use C6-02 [Carrier Frequency Selection] to decrease the carrier frequency. Decrease the length of the cable used between the drive and the motor. Install a noise filter or AC reactor on the output side of the drive. Set C6-02 = 1 [2.0 kHz] when connecting an AC reactor.

◆ Motor Rotation Causes Unexpected Audible Noise from Connected Machinery

Causes	Possible Solutions
The carrier frequency and the resonant frequency of the connected machinery are the same.	<ul style="list-style-type: none"> Adjust C6-02 to C6-05 [Carrier Frequency]. Set C6-02 = 1 to 6 [Carrier Frequency Selection = Frequency other than Swing PWM]. <p>Note: If C6-02 = 7 to A [Carrier Frequency Selection = Swing PWM], the drive will not know if the noise comes from the drive or the machine.</p>
The drive output frequency and the resonant frequency of the connected machinery are the same.	<ul style="list-style-type: none"> Adjust d3-01 to d3-04 [Jump Frequency]. Put the motor on a rubber pad to decrease vibration.

◆ Motor Rotation Causes Oscillation or Hunting

Causes	Possible Solutions
The frequency reference is assigned to an external source, and there is electrical interference in the signal.	<p>Make sure that electrical interference does not have an effect on the signal lines.</p> <ul style="list-style-type: none"> Isolate control circuit wiring from main circuit wiring. Use twisted-pair cables or shielded wiring for the control circuit. Increase the value of H3-13 [Analog Input Filter Time Constant].
The cable between the drive and motor is too long.	<ul style="list-style-type: none"> Do Auto-Tuning. Make the wiring as short as possible.
The PID parameters are not sufficiently adjusted.	Adjust b5-xx [PID control].

◆ PID Output Fault

Causes	Possible Solutions
There is no PID feedback input.	<ul style="list-style-type: none"> Examine the MFAI terminal settings. See if H3-02, H3-10, H3-06 = B [MFAI Function Select = PID Feedback] is set. Make sure that the MFAI terminal settings agree with the signal inputs. Examine the connection of the feedback signal. Make sure that b5-xx [PID Control] is set correctly. <p>Note: If there is no PID feedback input to the terminal, the detected value is 0, which causes a PID fault and also causes the drive to operate at maximum frequency.</p>
The detection level and the target value do not agree.	<p>Use H3-03, H3-11, H3-07 [Terminal A1, A2, A3 Gain Setting] to adjust PID target and feedback signal scaling.</p> <p>Note: PID control keeps the difference between the target value and detection value at 0. Set the input level for the values relative to each other.</p>
Reverse drive output frequency and speed detection. When output frequency increases, the sensor detects a speed decrease.	Set b5-09 = 1 [PID Output Level Selection = Reverse output (reverse acting)].

◆ The Starting Torque Is Not Sufficient

Causes	Possible Solutions
Auto-Tuning has not been done in vector control method.	Do Auto-Tuning.
The control method was changed after doing Auto-Tuning.	Do Auto-Tuning again.
Stationary Auto-Tuning for Line-to-Line Resistance was done.	Do Rotational Auto-Tuning.

◆ The Motor Rotates after the Drive Output Is Shut Off

Causes	Possible Solutions
DC Injection Braking is too low and the drive cannot decelerate correctly.	<ul style="list-style-type: none"> Increase the value set in b2-02 [DC Injection Braking Current]. Increase the value set in b2-04 [DC Inject Braking Time at Stop].
The stopping method makes the drive coast to stop.	Set b1-03 = 0 or 2 [Stopping Method Selection = Ramp to Stop, DC Injection Braking to Stop].

◆ The Output Frequency Is Lower Than the Frequency Reference

Causes	Possible Solutions
The frequency reference is in the Jump frequency range.	<p>Adjust d3-01 to d3-03 [Jump Frequency 1 to 3] and d3-04 [Jump Frequency Width].</p> <p>Note: Enabling the Jump frequency prevents the drive from outputting the frequencies specified in the Jump range.</p>
The upper limit for the frequency reference has been exceeded.	<p>Set E1-04 [Maximum Output Frequency] and d2-01 [Frequency Reference Upper Limit] to the best values for the application.</p> <p>Note: This calculation supplies the upper value for the output frequency: $E1-04 \times d2-01 / 100$</p>
A large load triggered Stall Prevention function during acceleration.	<ul style="list-style-type: none"> Decrease the load. Adjust L3-02 [Stall Prevent Level during Accel].
L3-01 = 3 [Stall Prevent Select during Accel = ILim Mode] has been set.	<ol style="list-style-type: none"> Check whether the V/f pattern and motor parameter settings are appropriate, and set them correctly. If this does not solve the problem, and it is not necessary to limit the current level of stall during acceleration, adjust L3-02. If this does not solve the problem, set L3-01 = 1 [Enabled].
The motor is rotating at this speed: b2-01 [DC Injection/Zero SpeedThreshold] ≤ Motor Speed < E1-09 [Minimum Output Frequency]	<ul style="list-style-type: none"> Set b1-21 = 1 [CLV Start Selection = Accept Run command at any speed]. Set E1-09 < b2-01.

◆ The Motor Is Making an Audible Noise

Causes	Possible Solutions
100% of the rated output current of the drive was exceeded while operating at low speeds.	<ul style="list-style-type: none"> • If the sound is coming from the motor, set $L8-38 = 0$ [<i>Carrier Frequency Reduction = Disabled</i>]. • If $oL2$ [<i>Drive Overloaded</i>] occurs frequently after setting $L8-38 = 0$, replace the drive with a high-capacity drive.

◆ The Motor Will Not Restart after a Loss of Power

Causes	Possible Solutions
The drive did not receive a Run command after applying power.	<ul style="list-style-type: none"> • Examine the sequence and wiring that enters the Run command. • Set up a relay to make sure that the Run command stays enabled during a loss of power.
For applications that use 3-wire sequence, the momentary power loss continued for a long time, and the relay that keeps the Run command has been switched off.	Examine the wiring and circuitry for the relay that keeps the Run command enabled during the momentary power loss ride-thru time.

Periodic Inspection and Maintenance

This chapter gives information about how to examine and maintain drives in use, how to replace cooling fans and other parts, and how to store drives.

8.1	Section Safety	372
8.2	Inspection.....	374
8.3	Maintenance	377
8.4	Replace Cooling Fans and Circulation Fans.....	380
8.5	Replace the Drive	417
8.6	Replace the Keypad Battery	423
8.7	Storage Guidelines	425

8.1 Section Safety

DANGER

Electrical Shock Hazard

Do not examine, connect, or disconnect wiring on an energized drive. Before servicing, disconnect all power to the equipment and wait for the time specified on the warning label at a minimum. The internal capacitor stays charged after the drive is de-energized. The charge indicator LED extinguishes when the DC bus voltage decreases below 50 Vdc. When all indicators are OFF, remove the covers before measuring for dangerous voltages to make sure that the drive is safe.

If you do work on the drive when it is energized, it will cause serious injury or death from electrical shock. The drive has internal capacitors that stay charged after you de-energize the drive.

Disconnect all power to the drive and wait for the time specified on the warning label before you remove covers. Check the drive for dangerous voltages before servicing or repair work.

If you do work on the drive when it is energized and there is no cover over the electronic circuits, it will cause serious injury or death from electrical shock. The drive has internal capacitors that stay charged after you de-energize the drive.

WARNING

Electrical Shock Hazard

The motor will run after you de-energize the drive. PM motors can generate induced voltage to the terminal of the motor after you de-energize the drive.

If you touch a motor that is moving or energized, it can cause serious injury or death.

Do not operate the drive when covers are missing. Replace covers and shields before you operate the drive. Use the drive only as specified by the instructions.

Some figures in this section include drives without covers or safety shields to more clearly show the inside of the drive. If covers or safety shields are missing from the drive, it can cause serious injury or death.

Always ground the motor-side grounding terminal.

If you do not ground the equipment correctly, it can cause serious injury or death if you touch the motor case.

Only let approved personnel install, wire, maintain, examine, replace parts, and repair the drive.

If personnel are not approved, it can cause serious injury or death.

Do not wear loose clothing or jewelry when you do work on the drive. Tighten loose clothing and remove all metal objects, for example watches or rings.

Loose clothing can catch on the drive and jewelry can conduct electricity and cause serious injury or death.

Fire Hazard

Tighten all terminal screws to the correct tightening torque.

Connections that are too loose or too tight can cause incorrect operation and damage to the drive. Incorrect connections can also cause death or serious injury from fire.

Damage to Equipment

Do not apply incorrect voltage to the main circuit of the drive. Operate the drive in the specified range of the input voltage on the drive nameplate.

Voltages that are higher than the permitted nameplate tolerance can cause damage to the drive.

Fire Hazard

Do not put flammable or combustible materials on top of the drive and do not install the drive near flammable or combustible materials. Attach the drive to metal or other noncombustible material.

Flammable and combustible materials can start a fire and cause serious injury or death.

⚠ WARNING**Electrical Shock Hazard**

Do not modify the drive body or drive circuitry.

Modifications to drive body and circuitry can cause serious injury or death, will cause damage to the drive, and will void the warranty. Yaskawa is not responsible for modifications of the product made by the user.

Sudden Movement Hazard

Make sure that you align the phase order for the drive and motor when you connect the motor to drive output terminals U/T1, V/T2, and W/T3.

If the phase order is incorrect, it can cause the motor to run in reverse. If the motor accidentally runs in reverse, it can cause serious injury or death.

⚠ CAUTION**Burn Hazard**

Do not touch a hot drive heatsink. De-energize the drive, wait for a minimum of 15 minutes, then make sure that the heatsink is cool before you replace the cooling fans.

If you touch a hot drive heatsink, it can burn you.

NOTICE**Damage to Equipment**

When you touch the drive and circuit boards, make sure that you observe correct electrostatic discharge (ESD) procedures.

If you do not follow procedures, it can cause ESD damage to the drive circuitry.

Use the instructions in this manual to replace the cooling fans. When you do maintenance on the fans, replace all the fans to increase product life.

If you install the fans incorrectly, it can cause damage to the drive.

Make sure that all connections are correct after you install the drive and connect peripheral devices.

Incorrect connections can cause damage to the drive.

The drive can fail if users frequently turn the drive ON and OFF with the MC on the power source side to Run and Stop the drive. Incorrect operation can decrease the service life of the relay contacts and electrolytic capacitors.

If you frequently use the magnetic contactor on the power source side to Run and Stop the drive, it can cause drive failure.

Do not operate a drive or connected equipment that has damaged or missing parts.

You can cause damage to the drive and connected equipment.

Note:

Do not use unshielded cable for control wiring. Use shielded, twisted-pair wires and ground the shield to the ground terminal of the drive. Incorrect wiring can cause electrical interference and unsatisfactory system performance.

8.2 Inspection

Power electronics have limited life and can show changes in performance and deterioration of performance after years of use in usual conditions. To help prevent these problems, it is important to do preventive maintenance and regular inspection, and replace parts on the drive.

Drives contain different types of power electronics, for example power transistors, semiconductors, capacitors, resistors, fans, and relays. The electronics in the drive are necessary for correct motor control.

Follow the inspection lists in this chapter as a part of a regular maintenance program.

Note:

Examine the drive one time each year at a minimum.

The operating conditions, environmental conditions, and use conditions will have an effect on the examination frequency for connected equipment.

Examine the drive more frequently if you use the drive in bad conditions or in these conditions:

- High ambient temperatures
- Frequent starting and stopping
- Changes in the AC power supply or load
- Too much vibration or shock loading
- Dust, metal dust, salt, sulfuric acid, or chlorine atmospheres
- Unsatisfactory storage conditions.

◆ Recommended Daily Inspection

Table 8.1 gives information about the recommended daily inspection for Yaskawa drives. Examine the items in Table 8.1 each day to make sure that the components do not become unserviceable or fail. Make a copy of this checklist and put a check mark in the “Checked” column after each inspection.

Table 8.1 Daily Inspection Checklist

Inspection Area	Inspection Points	Corrective Action	Checked
Motor	Examine for unusual oscillation or noise coming from the motor.	<ul style="list-style-type: none"> • Check the load coupling. • Measure motor vibration. • Tighten all loose components. 	
Cooling System	Examine for unusual heat from the drive or motor and visible discoloration.	<ul style="list-style-type: none"> • Check for a load that is too heavy. • Tighten loose screws. • Check for a dirty heatsink or motor. • Measure the ambient temperature. 	
	Examine the cooling fans, circulation fans, and circuit board cooling fans.	<ul style="list-style-type: none"> • Check for a clogged or dirty fan. • Use the performance life monitor to check for correct fan operation. 	
Surrounding Environment	Make sure that the installation environment is applicable.	Remove the source of contamination or correct unsatisfactory environment.	
Load	Make sure that the drive output current is not more than the motor or drive rating for an extended period of time.	<ul style="list-style-type: none"> • Check for a load that is too heavy. • Check the correct motor parameter settings. 	
Power Supply Voltage	Examine main power supply and control voltages.	<ul style="list-style-type: none"> • Correct the voltage or power supply to agree with nameplate specifications. • Verify all main circuit phases. 	

◆ Recommended Periodic Inspection

Table 8.2 to Table 8.6 give information about the recommended periodic inspections for Yaskawa drives. Examine the drive one time each year at a minimum. The operating conditions, environmental conditions, and use conditions will have an effect on the examination frequency for connected equipment. You must use your experience with the application to select the correct inspection frequency for each drive installation. Periodic inspections will help to prevent performance deterioration and product failure. Make a copy of this checklist and put a check mark in the “Checked” column after each inspection.

DANGER! Electrical Shock Hazard. Do not examine, connect, or disconnect wiring on an energized drive. Before servicing, disconnect all power to the equipment and wait for the time specified on the warning label at a minimum. The internal capacitor stays charged after the drive is de-energized. The charge indicator LED extinguishes when the DC bus voltage decreases below 50 Vdc. When all indicators are OFF, remove the covers before measuring for dangerous voltages to make sure that the drive is safe. If you do work on the drive when it is energized, it will cause serious injury or death from electrical shock. The drive has internal capacitors that stay charged after you de-energize the drive.

Table 8.2 Main Circuit Periodic Inspection Checklist

Inspection Area	Inspection Points	Corrective Action	Checked
General	<ul style="list-style-type: none"> Examine equipment for discoloration from too much heat or deterioration. Examine for damaged parts. 	<ul style="list-style-type: none"> Replace damaged components as necessary. The drive does not have many serviceable parts and it could be necessary to replace the drive. 	
	Examine for dirt, unwanted particles, or dust on components.	<ul style="list-style-type: none"> Examine enclosure door seal. Use a vacuum cleaner to remove unwanted particles and dust without touching the components. If you cannot remove unwanted particles and dust with a vacuum cleaner, replace the components. 	
Conductors and Wiring	<ul style="list-style-type: none"> Examine wiring and connections for discoloration or damage. Examine wiring and connections for discoloration from too much heat. Examine wire insulation and shielding for discoloration and wear. 	Repair or replace damaged wiring.	
Terminal Block	Examine terminals for stripped, damaged, or loose connections.	<ul style="list-style-type: none"> Tighten loose screws. Replace damaged screws or terminals. <p>Note: On drive models, 2056, 2070, 4031, and 4038, you cannot replace the hex screws.</p>	
Electromagnetic Contactors and Relays	<ul style="list-style-type: none"> Examine contactors and relays for too much noise during operation. Examine coils for signs of too much heat, such as melted or broken insulation. 	<ul style="list-style-type: none"> Check coil voltage for overvoltage or undervoltage conditions. Replace broken relays, contactors, or circuit boards that you can remove. 	
Dynamic Braking Option	Examine the insulation for discoloration from too much heat.	If there is discoloration in the option, check to make sure that the wiring is not damaged. A small quantity of discoloration is not a problem.	
Electrolytic Capacitor	<ul style="list-style-type: none"> Examine for leaks, discoloration, or cracks. Examine if the cap has come off, if there is swelling, or if there are leaks from broken sides. 	The drive does not have many serviceable parts and it could be necessary to replace the drive.	
Diodes, IGBT (Power Transistor)	Examine for dust or other unwanted material collected on the surface.	Use a vacuum cleaner to remove unwanted particles and dust without touching the components.	

Table 8.3 Motor Periodic Inspection Checklist

Inspection Area	Inspection Points	Corrective Action	Checked
Operation Check	Check for increased vibration or unusual noise.	Stop the motor and contact approved maintenance personnel as necessary.	

Table 8.4 Control Circuit Periodic Inspection Checklist

Inspection Area	Inspection Points	Corrective Action	Checked
General	<ul style="list-style-type: none"> Examine terminals for stripped, damaged, or loose connections. Make sure that all terminals have been correctly tightened. 	<ul style="list-style-type: none"> Tighten loose screws. Replace damaged screws or terminals. If terminals are integral to a circuit board, it could be necessary to replace the control board or the drive. 	
Circuit Boards	<ul style="list-style-type: none"> Check for odor, discoloration, or rust. Make sure that all connections are correctly fastened. Make sure that the surface of the circuit board does not have dust or oil mist. 	<ul style="list-style-type: none"> Tighten loose connections. Use a vacuum cleaner to remove unwanted particles and dust without touching the components. If you cannot remove unwanted particles and dust with a vacuum cleaner, replace the components. Do not use solvents to clean the board. The drive does not have many serviceable parts and it could be necessary to replace the drive. 	

Table 8.5 Cooling System Periodic Inspection Checklist

Inspection Area	Inspection Points	Corrective Action	Checked
Cooling fan	<ul style="list-style-type: none"> • Check for unusual oscillation or unusual noise. • Check for damaged or missing fan blades. 	Clean or replace the fans as necessary.	
Heatsink	<ul style="list-style-type: none"> • Examine for dust or other unwanted material collected on the surface. • Examine for dirt. 	Use a vacuum cleaner to remove unwanted particles and dust without touching the components.	
Air Duct	Examine air intake, exhaust openings and make sure that there are no unwanted materials on the surface.	Clear blockages and clean air duct as necessary.	

Table 8.6 Keypad Periodic Inspection Checklist

Inspection Area	Inspection Points	Corrective Action	Checked
General	<ul style="list-style-type: none"> • Make sure that the keypad shows the data correctly. • Examine for dust or other unwanted material that collected on components in the area. • Make sure that the expected lifespan of the battery has not passed. 	<ul style="list-style-type: none"> • If you have problems with the display or the keys, contact Yaskawa or your nearest sales representative. • Clean the keypad. • Replace the Battery. 	

8.3 Maintenance

The drive Maintenance Monitors keep track of component wear and tell the user when the end of the estimated performance life is approaching. The Maintenance Monitors prevent the need to shut down the full system for unexpected problems. Users can set alarm notifications for the maintenance periods for these drive components:

- Cooling fan
- Electrolytic capacitor
- Soft charge bypass relay
- IGBT

Contact Yaskawa or your nearest sales representative for more information about part replacement.

◆ Replaceable Parts

You can replace these parts of the drive:

- Control circuit terminal board
- Cooling fan, circulation fan
- Keypad

Note:

Make sure that you use a keypad with FLASH number 1004 or later. Keypads with FLASH numbers 1003 and earlier will not show characters correctly.

If there is a failure in the main circuit, replace the drive.

If the drive is in the warranty period, contact Yaskawa or your nearest sales representative before you replace parts. Yaskawa reserves the right to replace or repair the drive as specified by the Yaskawa warranty policy.

DANGER! Electrical Shock Hazard. Do not examine, connect, or disconnect wiring on an energized drive. Before servicing, disconnect all power to the equipment and wait for the time specified on the warning label at a minimum. The internal capacitor stays charged after the drive is de-energized. The charge indicator LED extinguishes when the DC bus voltage decreases below 50 Vdc. When all indicators are OFF, remove the covers before measuring for dangerous voltages to make sure that the drive is safe. If you do work on the drive when it is energized, it will cause serious injury or death from electrical shock. The drive has internal capacitors that stay charged after you de-energize the drive.

◆ Part Replacement Guidelines

Table 8.7 shows the standard replacement period for replacement parts. When you replace these parts, make sure that you use Yaskawa replacement parts for the applicable model and design revision number of your drive.

Table 8.7 Standard Replacement Period

Parts	Standard Replacement Period
Cooling fan	10 years
Electrolytic capacitor ^{*1}	10 years

*1 If there is damage to parts that you cannot repair or replace, replace the drive.

Note:

The performance life estimate uses these operating conditions. Yaskawa provides these conditions so you can replace parts to maintain performance. Unsatisfactory conditions or heavy use will make it necessary for you to replace some parts more frequently than other parts. Operating conditions for performance life estimate:

- Yearly average
 - IP20/UL Open Type: 40 °C (104 °F)
 - IP20/UL Type 1: 30 °C (86 °F)
 - IP55/UL Type 12 Heatsink External Mounting; front side: 40 °C (104 °F)
 - IP55/UL Type 12 Heatsink External Mounting; back side: 30 °C (86 °F)
- Load factor
 - 80% maximum
- Operation time
 - 24 hours a day

◆ Monitors that Show the Lifespan of Drive Components

The drive keypad shows percentage values for the replacement parts to help you know when you must replace those components. Use the monitors in [Table 8.8](#) to see how close you are to the end of the useful life of a component. When the monitor value is 100%, the component is at the end of its useful life and there is an increased risk of drive malfunction. Yaskawa recommends that you check the maintenance period regularly to make sure that you get the maximum performance life.

Table 8.8 Performance Life Monitors

Monitor No.	Parts	Description
U4-03	Cooling fan	Shows the total operation time of fans as 0 to 99999 hours. After this value is 99999, the drive automatically resets it to 0.
U4-04		Shows the total fan operation time as a percentage of the specified maintenance period.
U4-05	Electrolytic capacitor	Shows the total capacitor usage time as a percentage of the specified maintenance period.
U4-06	Soft charge bypass relay	Shows the number of times the drive is energized as a percentage of the performance life of the inrush circuit.
U4-07	IGBT	Shows the percentage of the maintenance period reached by the IGBTs.

◆ Alarm Outputs for Maintenance Monitors

You can use *H2-xx [Multi-Function Digital Out]* to send a message that tells you when a specified component is near the end of its performance life estimate. Set *H2-xx* to the applicable value for your component as shown in [Table 8.9](#). When the specified component is near the end of its performance life estimate, the MFDO terminals set for *H2-xx = 2F [Maintenance Notification]* will turn ON, and the keypad will show an alarm that identifies the component to replace.

Table 8.9 Maintenance Period Alarms

Display	Alarm Name	Cause	Possible Solutions	Digital Outputs (Setting Value in H2-xx)
LT-1	Cooling Fan Maintenance Time	The cooling fan is at 90% of its expected performance life.	Replace the cooling fan, then set <i>o4-03 = 0 [Fan Operation Time Setting = 0 h]</i> to reset the cooling fan operation time.	2F
LT-2	Capacitor Maintenance Time	The capacitors for the main circuit and control circuit are at 90% of expected performance life.	Replace the board or the drive. Contact Yaskawa or your nearest sales representative to replace the board.	
LT-3	SoftChargeBypassRelay MainteTime	The soft charge bypass relay is at 90% of its performance life estimate.	Replace the board or the drive. Contact Yaskawa or your nearest sales representative to replace the board.	
LT-4	IGBT Maintenance Time (50%)	The IGBT is at 50% of its expected performance life.	Check the load, carrier frequency, and output frequency.	
TrPC	IGBT Maintenance Time (90%)	The IGBT is at 90% of its expected performance life.	Replace the IGBT or the drive.	10

◆ Related Parameters

Replace the component, then set *o4-03*, *o4-05*, *o4-07*, and *o4-09 [Maintenance Setting] = 0* to reset the Maintenance Monitor. If you do not reset these parameters after you replace the parts, the Maintenance Monitor function will continue to count down the performance life from the value from the previous part. If you do not reset the Maintenance Monitor, the drive will not have the correct value of the performance life for the new part.

Note:

The maintenance period changes for different operating environments.

Table 8.10 Maintenance Setting Parameters

No.	Name	Function
o4-03	Fan Operation Time Setting	Sets the value from which to start the cumulative drive cooling fan operation time in 10-hour units. Note: When <i>o4-03 = 30</i> has been set, the drive will count the operation time for the cooling fan from 300 hours and <i>U4-03 [Cooling Fan Ope Time]</i> will show <i>300 h</i> .
o4-05	Capacitor Maintenance Setting	Sets the value from which to start the count for the main circuit capacitor maintenance period as a percentage.

No.	Name	Function
o4-07	Softcharge Relay Maintenance Set	Sets as a percentage the value from which to start the count for the soft charge bypass relay maintenance time.
o4-09	IGBT Maintenance Setting	Sets the value from which to start the count for the IGBT maintenance period as a percentage.

8.4 Replace Cooling Fans and Circulation Fans

NOTICE: Use the instructions in this manual to replace the cooling fans. When you do maintenance on the fans, replace all the fans to increase product life. If you install the fans incorrectly, it can cause damage to the drive.

◆ Cooling Fans and Circulation Fans by Drive Model

Table 8.11 Cooling Fans and Circulation Fans (Three-Phase 200 V)

Model	Cooling Fan	Circulation Fan	Replacement Procedure	Reference
2004 - 2012	-	-	-	-
2018, 2021	1	-	Procedure A	380
2030, 2042	2	-	Procedure B	383
2056 - 2082	2	-	Procedure C	385
2110 - 2211	2	-	Procedure D	388
2257 - 2313	2	-	Procedure E	390
2360, 2415	3	1	Procedure F	393

Table 8.12 Cooling Fans and Circulation Fans (Three-Phase 400 V)

Model	Cooling Fan	Circulation Fan	Circuit Board Cooling Fan	Replacement Procedure	Reference
4002 - 4005	-	-	-	-	-
4007 - 4012	1	-	-	Procedure A	380
4018, 4023	2	-	-	Procedure B	383
4031 - 4060	2	-	-	Procedure C	385
4075 - 4168	2	-	-	Procedure D	388
4208 - 4302	2	-	-	Procedure E	390
4371	2	1	-	Procedure F	393
4414	3	1	-	Procedure F	393
4477 - 4605	2	1	2	Procedure G	400
4720	3	1	2	Procedure H	409

◆ Replace a Fan (Procedure A)

DANGER! Electrical Shock Hazard. Do not examine, connect, or disconnect wiring on an energized drive. Before servicing, disconnect all power to the equipment and wait for the time specified on the warning label at a minimum. The internal capacitor stays charged after the drive is de-energized. The charge indicator LED extinguishes when the DC bus voltage decreases below 50 Vdc. When all indicators are OFF, remove the covers before measuring for dangerous voltages to make sure that the drive is safe. If you do work on the drive when it is energized, it will cause serious injury or death from electrical shock. The drive has internal capacitors that stay charged after you de-energize the drive.

CAUTION! Burn Hazard. Do not touch a hot drive heatsink. De-energize the drive, wait for a minimum of 15 minutes, then make sure that the heatsink is cool before you replace the cooling fans. If you touch a hot drive heatsink, it can burn you.

NOTICE: Use the instructions in this manual to replace the cooling fans. When you do maintenance on the fans, replace all the fans to increase product life. If you install the fans incorrectly, it can cause damage to the drive.

■ Remove a Fan

1. To remove the fan finger guard from the drive, push the hooks on the left and right sides of it and pull up.

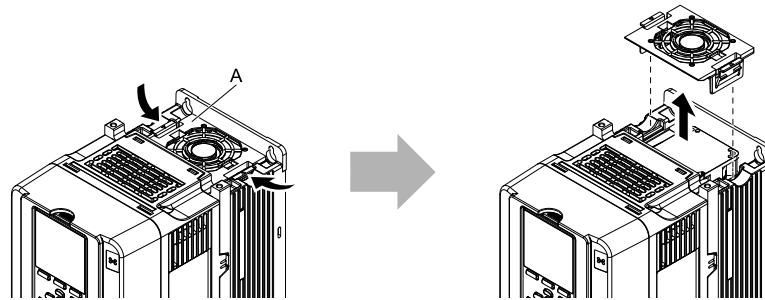

A - Fan finger guard

Figure 8.1 Remove the Fan Finger Guard

2. Pull the cooling fan straight up from the drive. Disconnect the power supply connector and remove the fan from the drive.

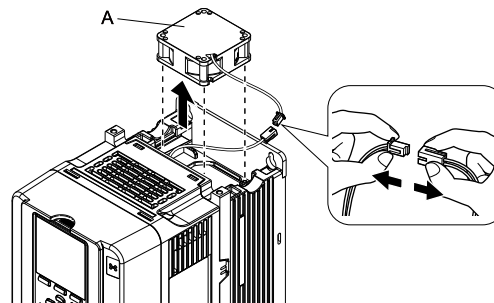

A - Cooling fan

Figure 8.2 Remove the Cooling Fans

■ Install the Cooling Fans

Reverse the removal procedure to install a cooling fan.

1. Connect the drive and the fan connectors.

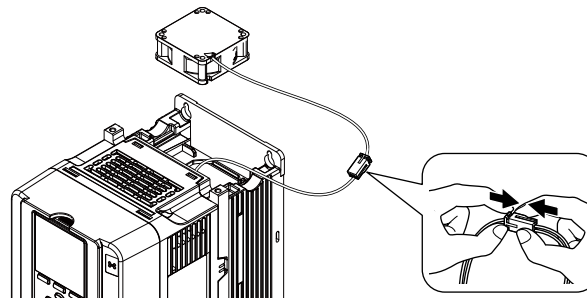
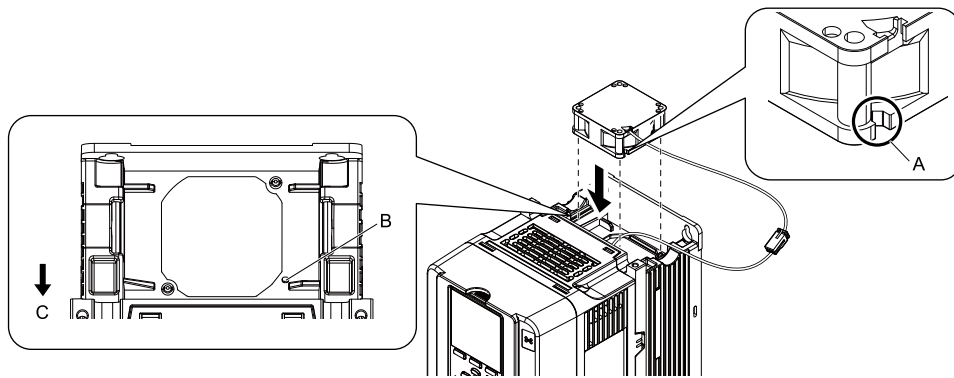

Figure 8.3 Connect the Power Supply Connector

- Align the notches on the fan with the pins on the drive and install the cooling fan in the drive.



A - Notch on fan

B - Alignment pins on drive

C - Front of drive

Figure 8.4 Install the Cooling Fans

Note:

When you install the cooling fan, make sure that you do not pinch cables between the cooling fan and the drive.

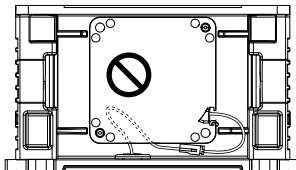

- Put the cable in the recess of the drive.

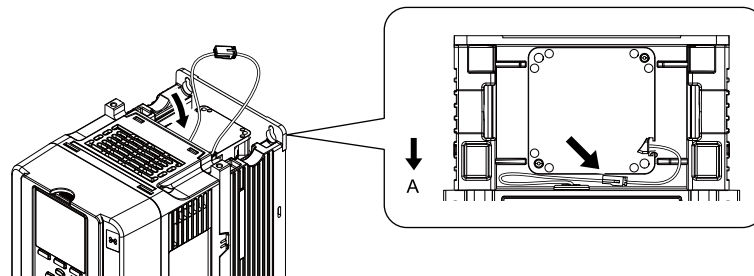

A - Front of drive

Figure 8.5 Put the Cable in the Drive Recess

- Insert the fan finger guard straight until the hook clicks into place.

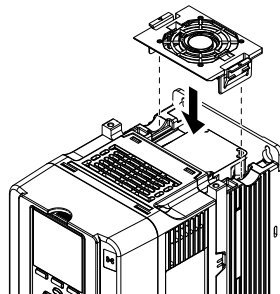

Figure 8.6 Reattach the Fan Finger Guard

- Energize the drive and set $\alpha 4-03 = 0$ [Fan Operation Time Setting = 0 h] to reset the cooling fan operation time.

◆ Replace a Fan (Procedure B)

DANGER! Electrical Shock Hazard. Do not examine, connect, or disconnect wiring on an energized drive. Before servicing, disconnect all power to the equipment and wait for the time specified on the warning label at a minimum. The internal capacitor stays charged after the drive is de-energized. The charge indicator LED extinguishes when the DC bus voltage decreases below 50 Vdc. When all indicators are OFF, remove the covers before measuring for dangerous voltages to make sure that the drive is safe. If you do work on the drive when it is energized, it will cause serious injury or death from electrical shock. The drive has internal capacitors that stay charged after you de-energize the drive.

CAUTION! Burn Hazard. Do not touch a hot drive heatsink. De-energize the drive, wait for a minimum of 15 minutes, then make sure that the heatsink is cool before you replace the cooling fans. If you touch a hot drive heatsink, it can burn you.

NOTICE: Use the instructions in this manual to replace the cooling fans. When you do maintenance on the fans, replace all the fans to increase product life. If you install the fans incorrectly, it can cause damage to the drive.

■ Remove a Fan

1. To remove the fan finger guard from the drive, push the hook on the back side of the fan finger guard and pull up.

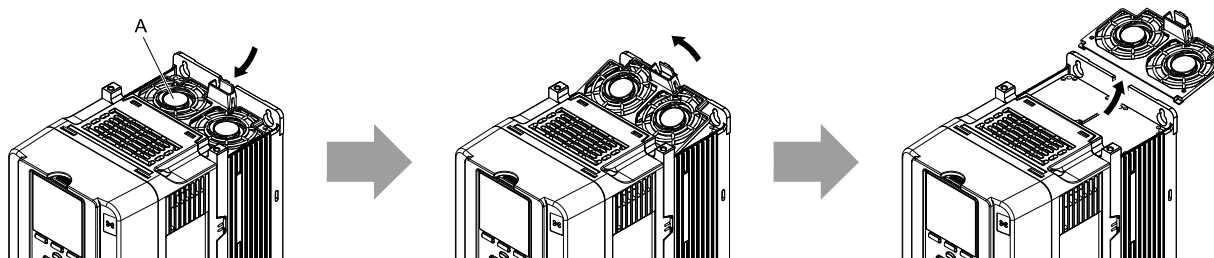

A - Fan finger guard

Figure 8.7 Remove the Fan Finger Guard

2. Pull the cooling fan straight up from the drive. Disconnect the power supply connector and remove the fan from the drive.

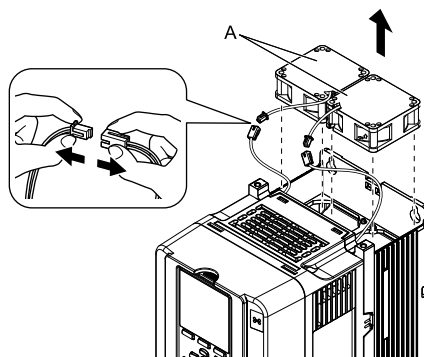

A - Cooling fan

Figure 8.8 Remove the Cooling Fans

■ Install Fans

Reverse the removal procedure to install a cooling fan.

1. Connect the power supply connector.

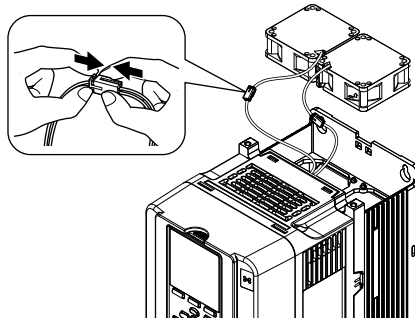
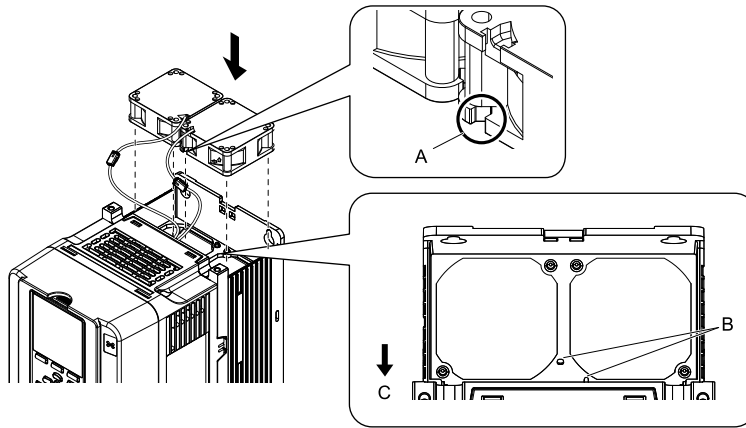

Figure 8.9 Connect the Power Supply Connector

2. Align the notches on the fan with the pins on the drive and install the cooling fan in the drive.



A - Notch on fan
B - Alignment pins on drive

C - Front of drive

Figure 8.10 Install the Cooling Fans

Note:

When you install the cooling fan, make sure that you do not pinch cables between the cooling fan and the drive.

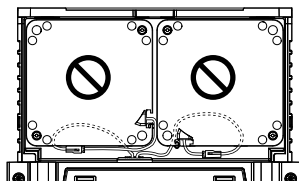

3. Put the cable in the recess of the drive.

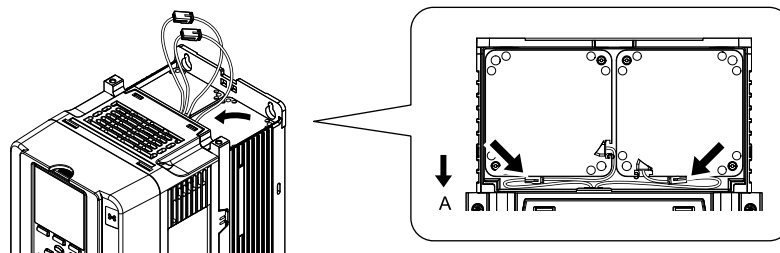

A - Front of drive

Figure 8.11 Put the Cable in the Drive Recess

4. Hold the fan finger guard at an angle and put the connector tabs on the fan finger guard into the holes on the drive.

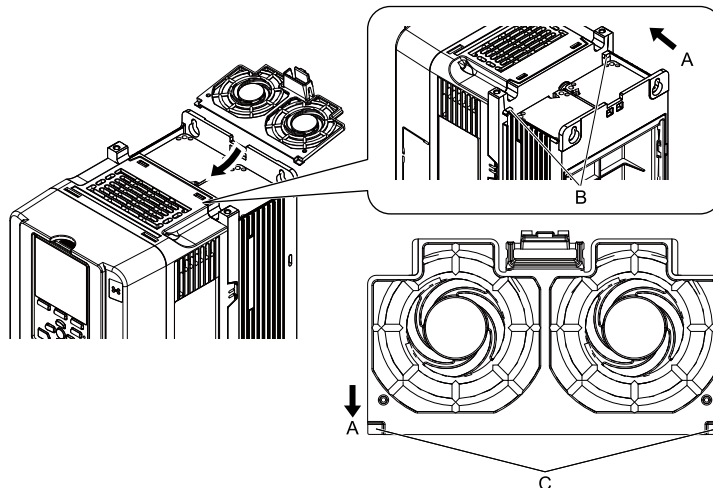

A - Front of drive
B - Drive holes

C - Tab

Figure 8.12 Reattach the Fan Finger Guard

5. Push the hook on the back side of the fan finger guard and click it into place on the drive.

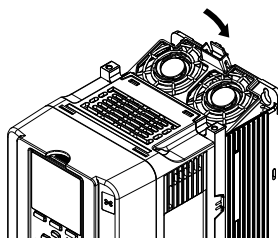

Figure 8.13 Reattach the Fan Finger Guard

6. Energize the drive and set $\alpha 4-03 = 0$ [Fan Operation Time Setting = 0 h] to reset the cooling fan operation time.

◆ Replace a Fan (Procedure C)

DANGER! Electrical Shock Hazard. Do not examine, connect, or disconnect wiring on an energized drive. Before servicing, disconnect all power to the equipment and wait for the time specified on the warning label at a minimum. The internal capacitor stays charged after the drive is de-energized. The charge indicator LED extinguishes when the DC bus voltage decreases below 50 Vdc. When all indicators are OFF, remove the covers before measuring for dangerous voltages to make sure that the drive is safe. If you do work on the drive when it is energized, it will cause serious injury or death from electrical shock. The drive has internal capacitors that stay charged after you de-energize the drive.

CAUTION! Burn Hazard. Do not touch a hot drive heatsink. De-energize the drive, wait for a minimum of 15 minutes, then make sure that the heatsink is cool before you replace the cooling fans. If you touch a hot drive heatsink, it can burn you.

NOTICE: Use the instructions in this manual to replace the cooling fans. When you do maintenance on the fans, replace all the fans to increase product life. If you install the fans incorrectly, it can cause damage to the drive.

■ Remove a Fan

1. To remove the fan finger guard from the drive, push the hooks on the left and right sides of it and pull up.

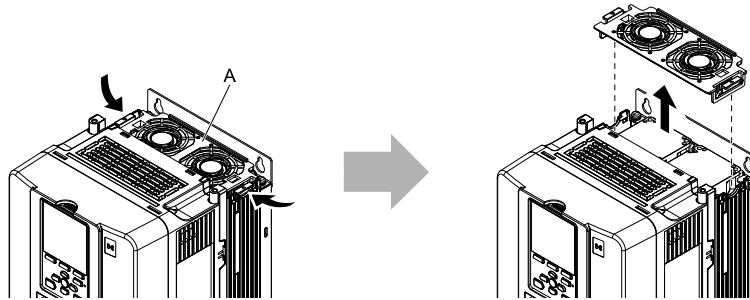

A - Fan finger guard

Figure 8.14 Remove the Fan Finger Guard

2. Pull the cooling fan straight up from the drive. Disconnect the power supply connector and remove the fan from the drive.

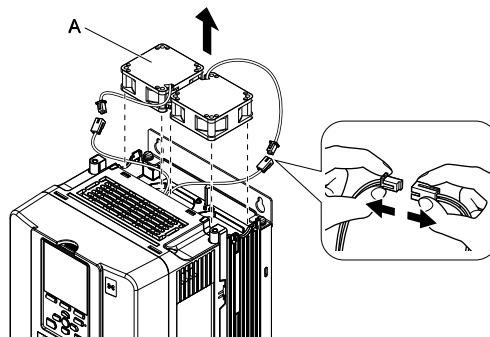

A - Cooling fan

Figure 8.15 Remove the Cooling Fans

■ Install Fans

Reverse the removal procedure to install a cooling fan.

1. Connect the drive and the fan connectors.

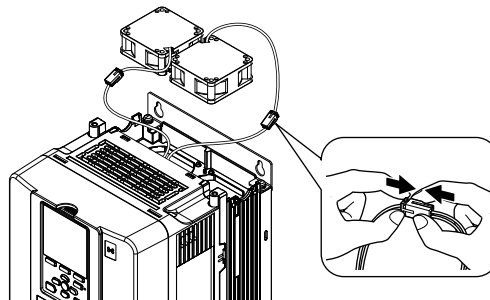
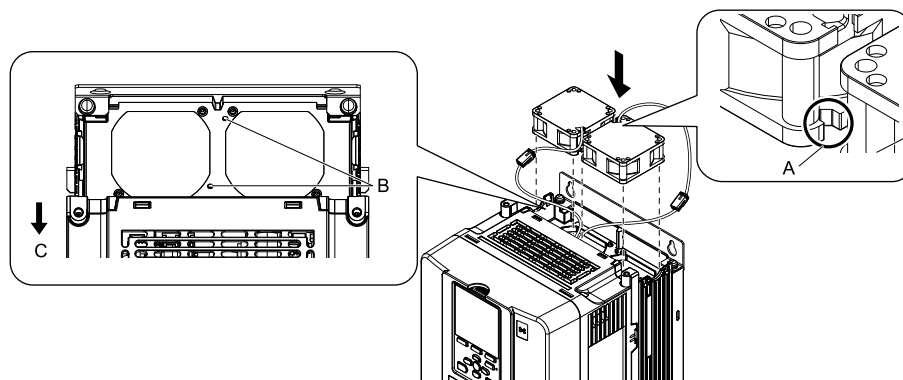

Figure 8.16 Connect the Power Supply Connector

- Align the notches on the fan with the pins on the drive and install the cooling fan in the drive.



A - Notch on fan

B - Alignment pins on drive

C - Front of drive

Figure 8.17 Install the Cooling Fans

Note:

When you install the cooling fan, make sure that you do not pinch cables between the cooling fan and the drive.

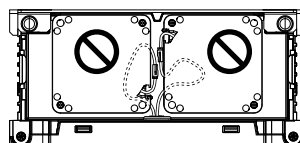

- Put the cable in the recess of the drive.

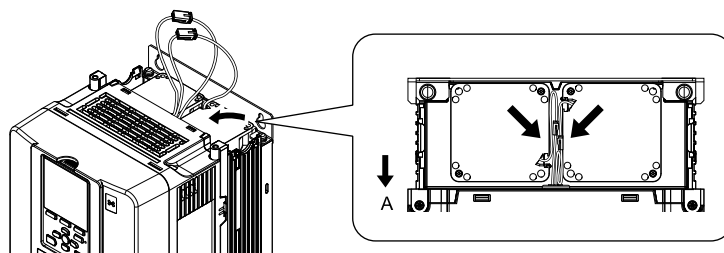

A - Front of drive

Figure 8.18 Put the Cable in the Drive Recess

- Insert the fan finger guard straight until the hook clicks into place.

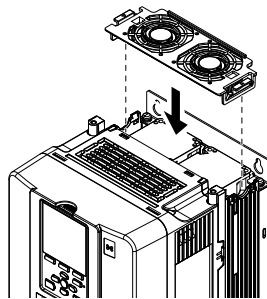

Figure 8.19 Reattach the Fan Finger Guard

- Energize the drive and set $o4-03 = 0$ [Fan Operation Time Setting = 0 h] to reset the cooling fan operation time.

◆ Replace a Fan (Procedure D)

DANGER! Electrical Shock Hazard. Do not examine, connect, or disconnect wiring on an energized drive. Before servicing, disconnect all power to the equipment and wait for the time specified on the warning label at a minimum. The internal capacitor stays charged after the drive is de-energized. The charge indicator LED extinguishes when the DC bus voltage decreases below 50 Vdc. When all indicators are OFF, remove the covers before measuring for dangerous voltages to make sure that the drive is safe. If you do work on the drive when it is energized, it will cause serious injury or death from electrical shock. The drive has internal capacitors that stay charged after you de-energize the drive.

CAUTION! Burn Hazard. Do not touch a hot drive heatsink. De-energize the drive, wait for a minimum of 15 minutes, then make sure that the heatsink is cool before you replace the cooling fans. If you touch a hot drive heatsink, it can burn you.

NOTICE: Use the instructions in this manual to replace the cooling fans. When you do maintenance on the fans, replace all the fans to increase product life. If you install the fans incorrectly, it can cause damage to the drive.

■ Remove a Fan

1. To remove the fan finger guard from the drive, push the hooks on the left and right sides of it and pull up.

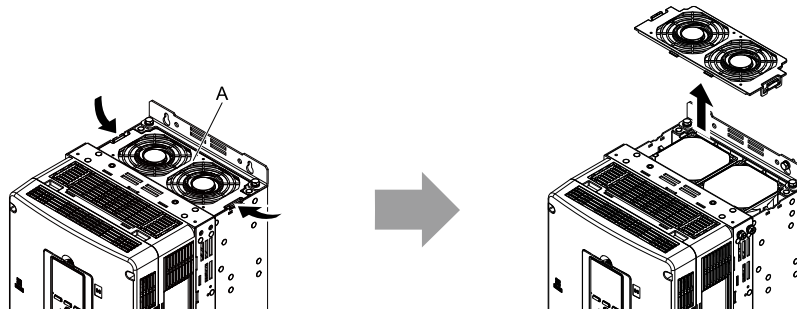

A - Fan finger guard

Figure 8.20 Remove the Fan Finger Guard

2. Pull the cooling fan straight up from the drive. Disconnect the power supply connector and remove the fan from the drive.

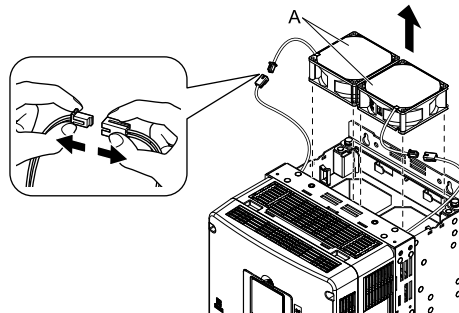

A - Cooling fan

Figure 8.21 Remove the Cooling Fan

■ Install the Cooling Fans

Reverse the removal procedure to install a cooling fan.

1. Connect the power supply connector.

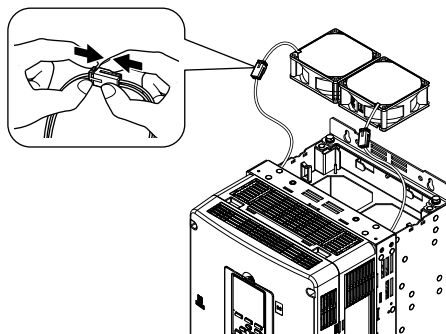
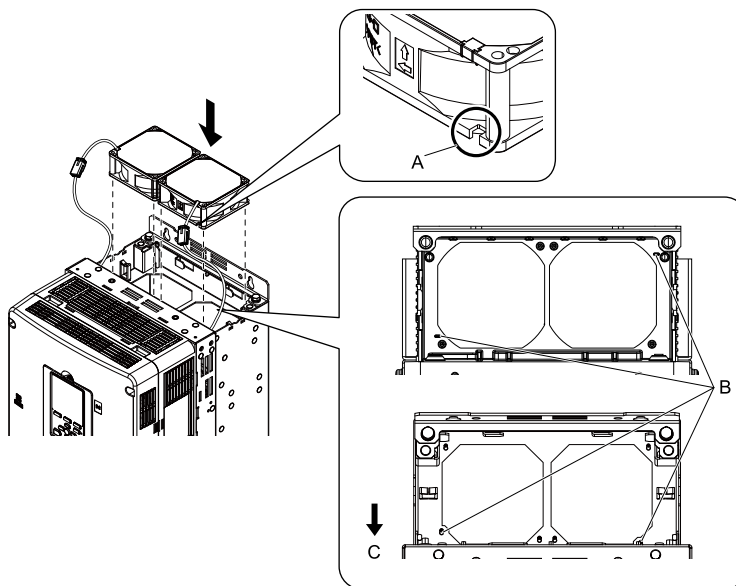

Figure 8.22 Connect the Power Supply Connector

2. Align the notches on the fan with the pins on the drive and install the cooling fan in the drive.



A - Notch on fan
B - Alignment pins on drive

C - Front of drive

Figure 8.23 Install the Cooling Fans

Note:

When you install the cooling fan, make sure that you do not pinch cables between the cooling fan and the drive.

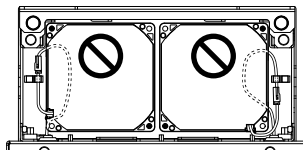

- Put the cable in the recess of the drive.

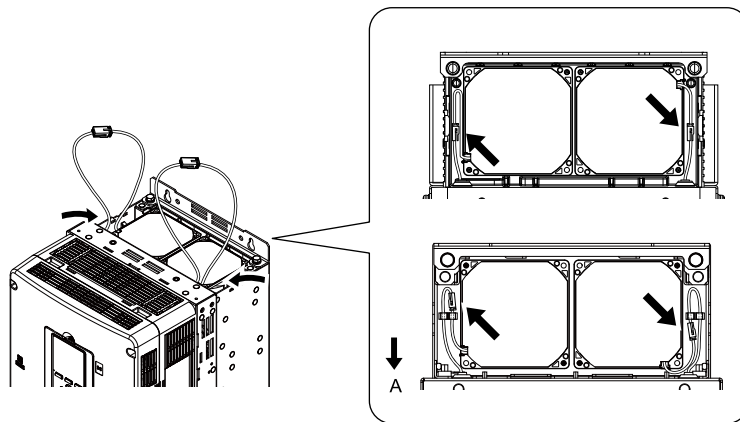

A - Front of drive

Figure 8.24 Put the Cable in the Drive Recess

- Push the hooks on the left and right sides of the fan finger guard and click it into place on the drive.

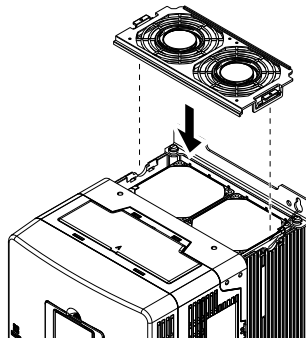

Figure 8.25 Reattach the Fan Finger Guard

- Energize the drive and set $\alpha 4-03 = 0$ [Fan Operation Time Setting = 0 h] to reset the cooling fan operation time.

◆ Replace a Fan (Procedure E)

DANGER! Electrical Shock Hazard. Do not examine, connect, or disconnect wiring on an energized drive. Before servicing, disconnect all power to the equipment and wait for the time specified on the warning label at a minimum. The internal capacitor stays charged after the drive is de-energized. The charge indicator LED extinguishes when the DC bus voltage decreases below 50 Vdc. When all indicators are OFF, remove the covers before measuring for dangerous voltages to make sure that the drive is safe. If you do work on the drive when it is energized, it will cause serious injury or death from electrical shock. The drive has internal capacitors that stay charged after you de-energize the drive.

CAUTION! Burn Hazard. Do not touch a hot drive heatsink. De-energize the drive, wait for a minimum of 15 minutes, then make sure that the heatsink is cool before you replace the cooling fans. If you touch a hot drive heatsink, it can burn you.

NOTICE: Use the instructions in this manual to replace the cooling fans. When you do maintenance on the fans, replace all the fans to increase product life. If you install the fans incorrectly, it can cause damage to the drive.

■ Remove a Fan

1. To remove the fan finger guard from the drive, push the tabs on the left and right sides of it and pull up the back side of the guard.

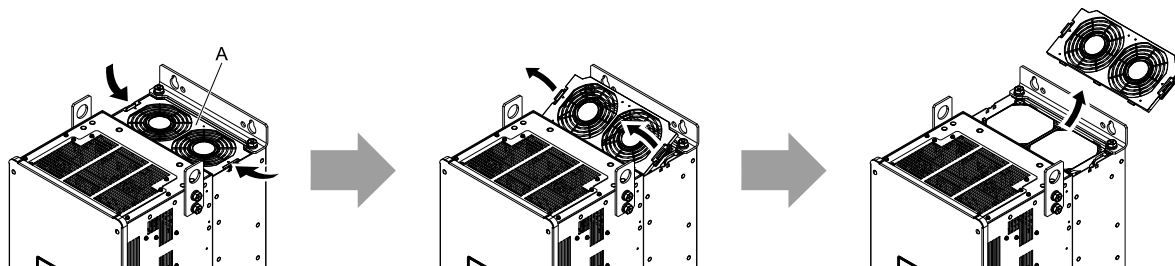

A - Fan finger guard

Figure 8.26 Remove the Fan Finger Guard

2. Pull the cooling fan straight up from the drive. Disconnect the power supply connector and remove the fan from the drive.

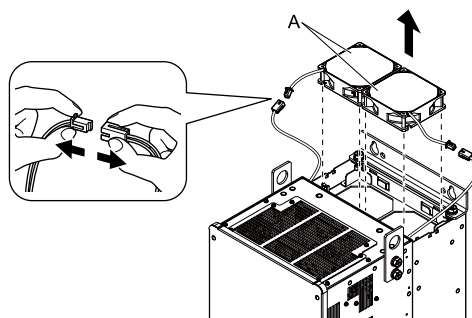

A - Cooling fan

Figure 8.27 Remove the Cooling Fans

■ Install the Cooling Fans

Reverse the removal procedure to install a cooling fan.

1. Connect the power supply connector.

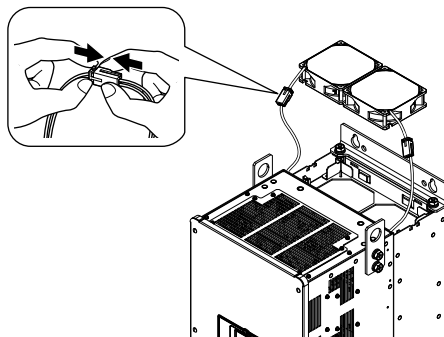
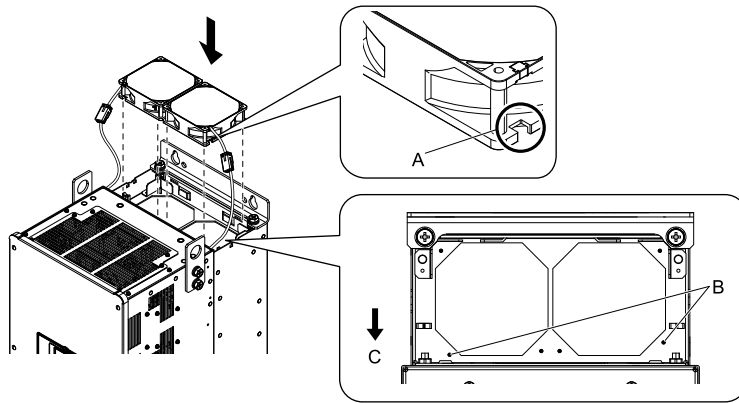

Figure 8.28 Connect the Power Supply Connector

- Align the notches on the fan with the pins on the drive and install the cooling fan in the drive.



A - Notch on fan
B - Alignment pins on drive

C - Front of drive

Figure 8.29 Install the Cooling Fans

Note:

When you install the cooling fan, make sure that you do not pinch cables between the cooling fan and the drive.

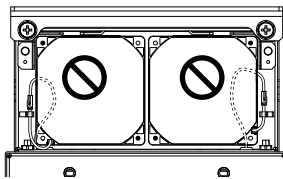

- Put the cable in the recess of the drive.

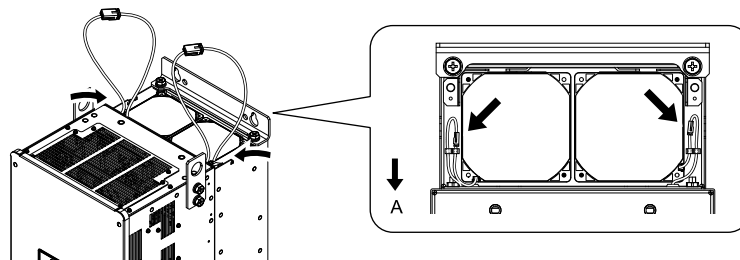

A - Front of drive

Figure 8.30 Put the Cable in the Drive Recess

4. Hold the fan finger guard at an angle and put the connector tabs on the fan finger guard into the holes on the drive.

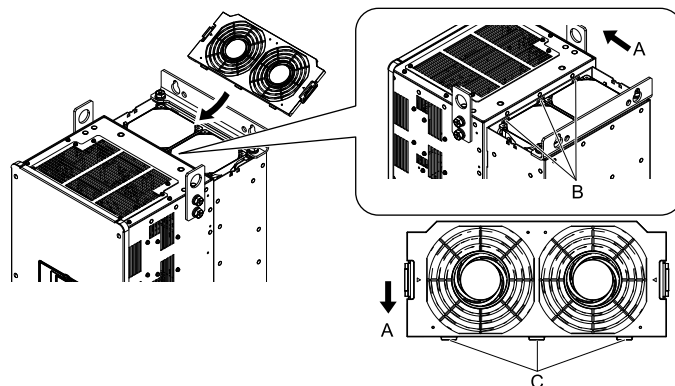

A - Front of drive
B - Drive holes

C - Tab

Figure 8.31 Reattach the Fan Finger Guard

5. Push the hooks on the left and right sides of the fan finger guard and click it into place on the drive.

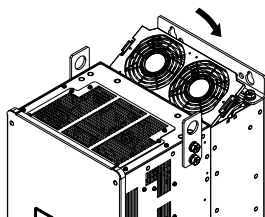

Figure 8.32 Reattach the Fan Finger Guard

6. Energize the drive and set $\alpha 4-03 = 0$ [Fan Operation Time Setting = 0 h] to reset the cooling fan operation time.

◆ Replace Fans (Procedure F)

DANGER! Electrical Shock Hazard. Do not examine, connect, or disconnect wiring on an energized drive. Before servicing, disconnect all power to the equipment and wait for the time specified on the warning label at a minimum. The internal capacitor stays charged after the drive is de-energized. The charge indicator LED extinguishes when the DC bus voltage decreases below 50 Vdc. When all indicators are OFF, remove the covers before measuring for dangerous voltages to make sure that the drive is safe. If you do work on the drive when it is energized, it will cause serious injury or death from electrical shock. The drive has internal capacitors that stay charged after you de-energize the drive.

CAUTION! Burn Hazard. Do not touch a hot drive heatsink. De-energize the drive, wait for a minimum of 15 minutes, then make sure that the heatsink is cool before you replace the cooling fans. If you touch a hot drive heatsink, it can burn you.

NOTICE: Use the instructions in this manual to replace the cooling fans. When you do maintenance on the fans, replace all the fans to increase product life. If you install the fans incorrectly, it can cause damage to the drive.

■ Remove a Fan

1. To remove the fan finger guards from the drive, push the hook on the back side of each guard and pull up.

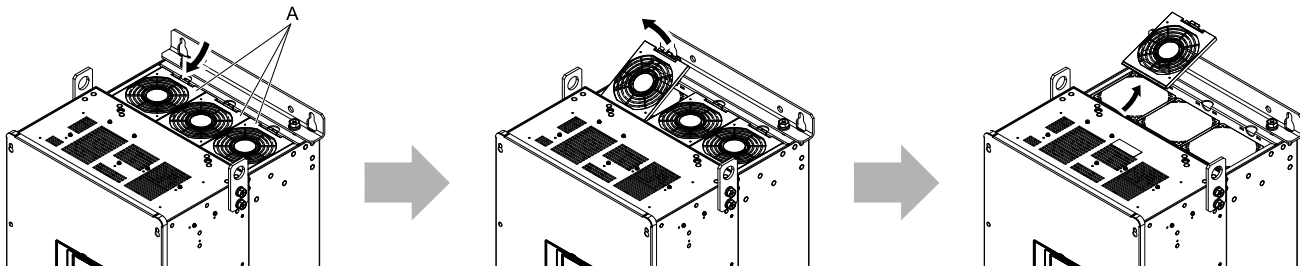

A - Fan finger guard

Figure 8.33 Remove the Fan Finger Guard

2. Pull the cooling fan straight up from the drive. Disconnect the power supply connector and remove the fan from the drive.

Note:

The number of fans is different for different drive models.

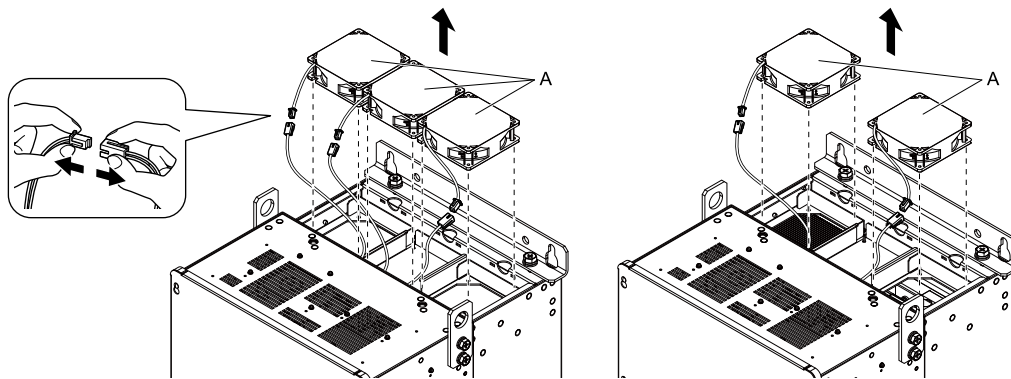

A - Cooling fan

Figure 8.34 Remove the Cooling Fans

■ Install the Cooling Fans

Reverse the removal procedure to install a fan unit.

1. Connect the power supply connector.

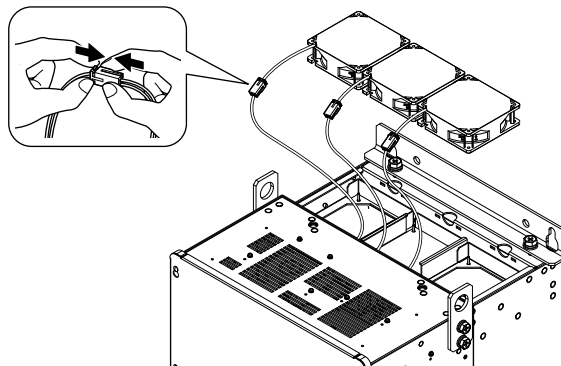

Figure 8.35 Connect the Power Supply Connector

- Align the notches on the fan with the pins on the drive and install the cooling fan in the drive.

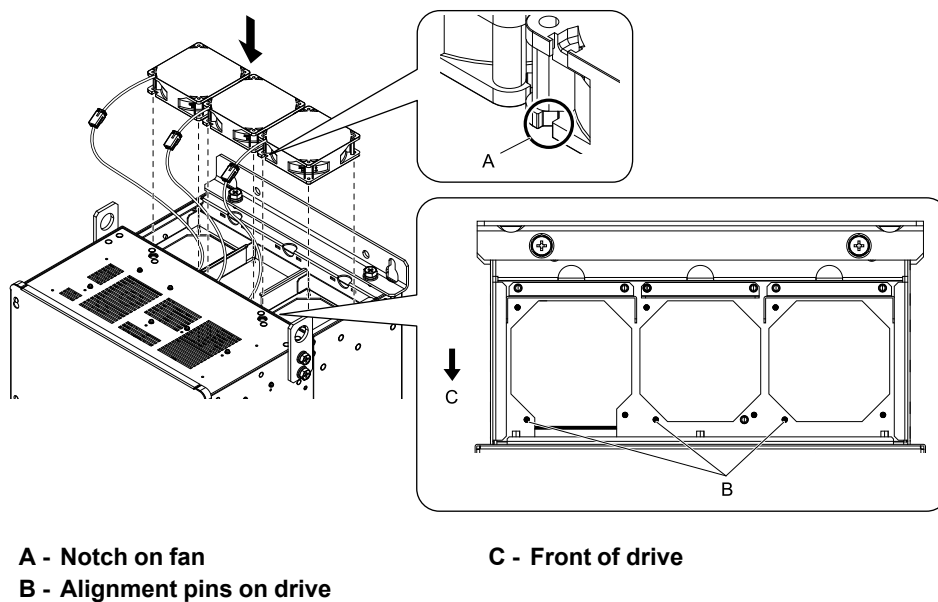
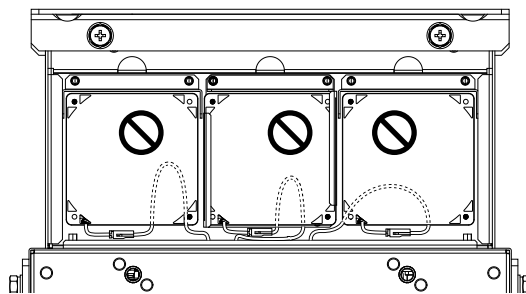

Figure 8.36 Install the Cooling Fans

Note:

When you install the cooling fan, make sure that you do not pinch cables between the cooling fan and the drive.



- Put the cable in the recess of the drive.

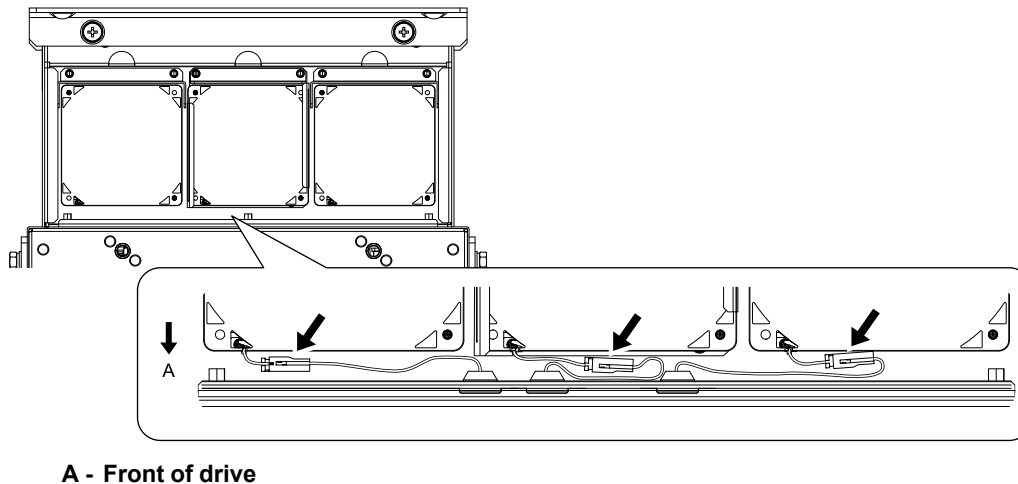

Figure 8.37 Put the Cable in the Drive Recess

- Hold the fan finger guard at an angle and put the connector tabs on the fan finger guard into the holes on the drive.

Note:

When you install the cooling fan, make sure that you do not pinch cables between the fan finger guard and the drive.

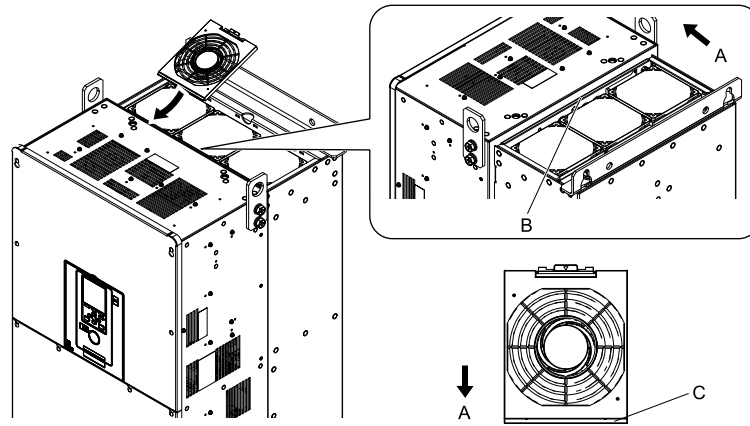

Figure 8.38 Reattach the Fan Finger Guard

5. Push the hook on the back side of the fan finger guard and click it into place on the drive.

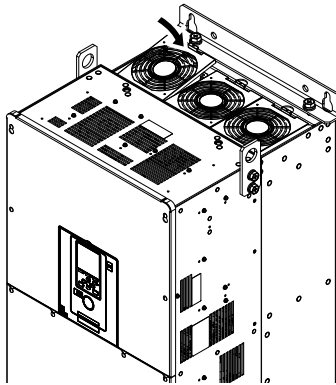

Figure 8.39 Reattach the Fan Finger Guard

6. Energize the drive and set $\alpha 4-03 = 0$ [Fan Operation Time Setting = 0 h] to reset the cooling fan operation time.

■ Remove a Circulation Fan

Remove the drive cover before you start this procedure.

CAUTION! *Crush Hazard. Loosen the cover screws. Do not fully remove them. If you fully remove the cover screws, the terminal cover can fall and cause moderate injury.*

1. Disconnect the cable from the hook.

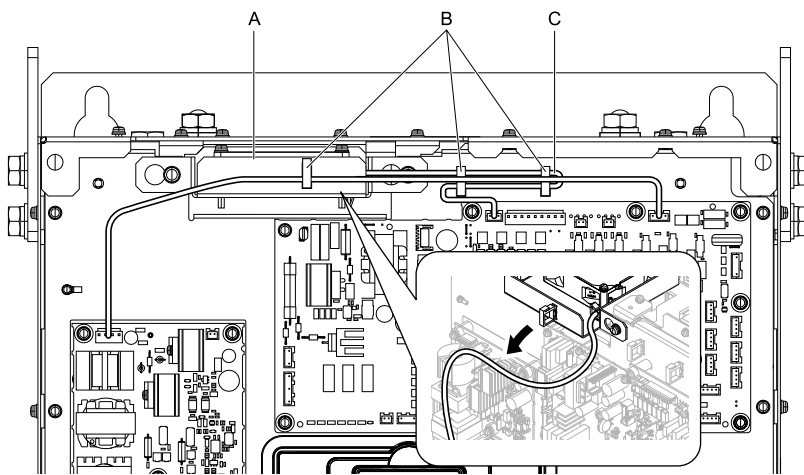

A - Fan unit
B - Hook

C - Fan cable

Figure 8.40 Components

2. Loosen the fan unit screws and slide the fan unit to the right.

Note:

To remove the fan unit, it is only necessary to loosen the screws.

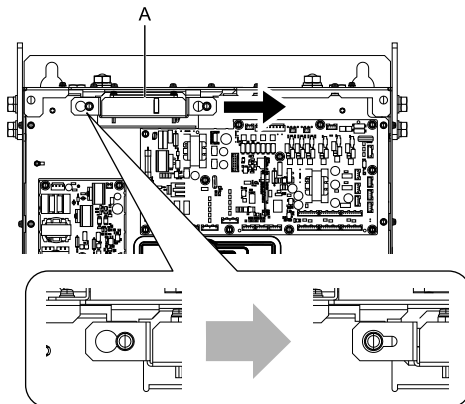

A - Fan unit

Figure 8.41 Slide the Fan Unit

3. Disconnect the relay connector and remove the fan unit.

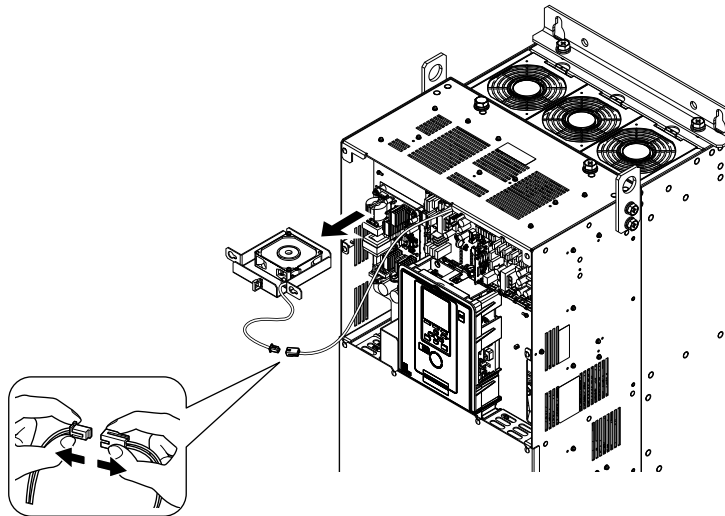
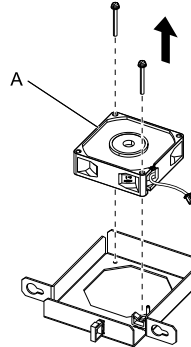

Figure 8.42 Remove the Fan Unit

4. Remove the screws that safety the cooling fan and remove the fan.



A - Cooling fan

Figure 8.43 Remove the Cooling Fan

■ Install a Circulation Fan

Reverse the removal procedure to install a circulation fan.

1. Connect the power supply connector.

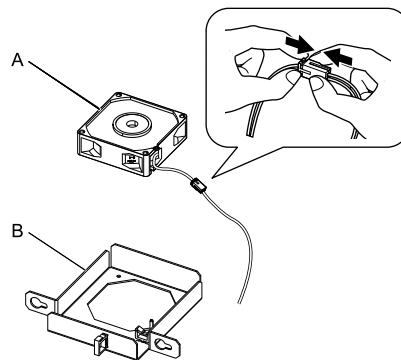

A - Cooling fan

B - Fan unit base

Figure 8.44 Connect the Power Supply Connector

- Align the pins on the fan unit base with the notches on the fan and put the fan unit base in the fan unit, then use the screws to safety it.
Tighten the M4 screws to a tightening torque of 0.98 N·m to 1.33 N·m (8.67 in·lb to 11.77 in·lb).

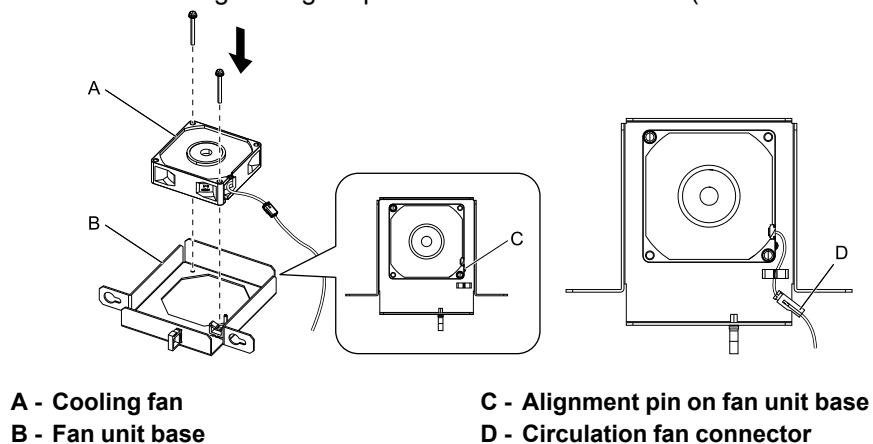
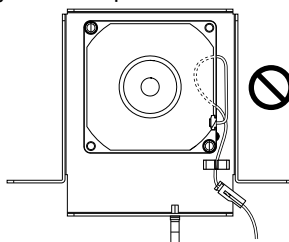

Figure 8.45 Install the Cooling Fan

Note:

When you install the cooling fan, make sure that you do not pinch cables between the cooling fan and the fan unit base.



- Put the fan unit into the specified location and slide it to the left, then use screws to safety it to the drive.
Tighten the screws to a tightening torque of 0.98 N·m to 1.33 N·m (8.67 in·lb to 11.77 in·lb).

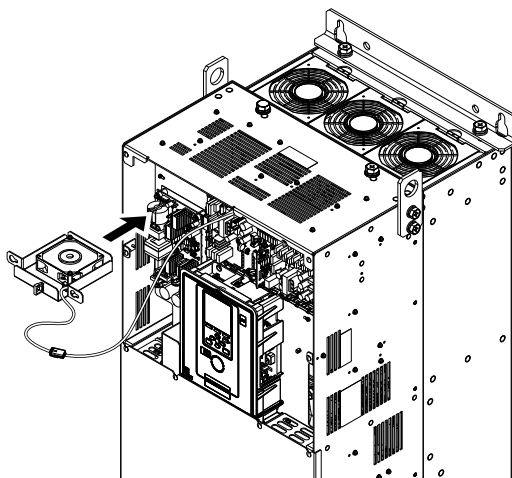
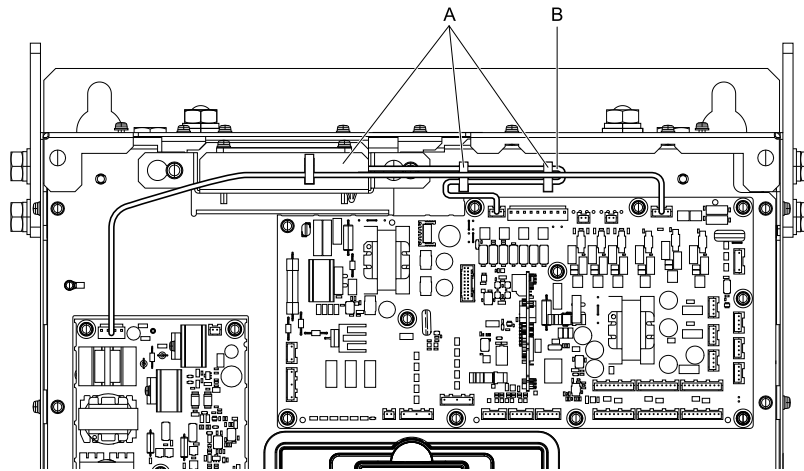

Figure 8.46 Install the Fan Unit

- Hook the cable to the hook.



A - Hook

B - Fan cable

- Install the drive cover.
- Energize the drive and set $o4-03 = 0$ [*Fan Operation Time Setting = 0 h*] to reset the cooling fan operation time.

◆ Replace Fans (Procedure G)

DANGER! *Electrical Shock Hazard. Do not examine, connect, or disconnect wiring on an energized drive. Before servicing, disconnect all power to the equipment and wait for the time specified on the warning label at a minimum. The internal capacitor stays charged after the drive is de-energized. The charge indicator LED extinguishes when the DC bus voltage decreases below 50 Vdc. When all indicators are OFF, remove the covers before measuring for dangerous voltages to make sure that the drive is safe. If you do work on the drive when it is energized, it will cause serious injury or death from electrical shock. The drive has internal capacitors that stay charged after you de-energize the drive.*

CAUTION! *Burn Hazard. Do not touch a hot drive heatsink. De-energize the drive, wait for a minimum of 15 minutes, then make sure that the heatsink is cool before you replace the cooling fans. If you touch a hot drive heatsink, it can burn you.*

NOTICE: *Use the instructions in this manual to replace the cooling fans. When you do maintenance on the fans, replace all the fans to increase product life. If you install the fans incorrectly, it can cause damage to the drive.*

■ Remove a Fan

- Remove the drive cover.

CAUTION! *Crush Hazard. Loosen the cover screws. Do not fully remove them. If you fully remove the cover screws, the terminal cover can fall and cause moderate injury.*

2. Unplug the fan cables from the fan connectors.

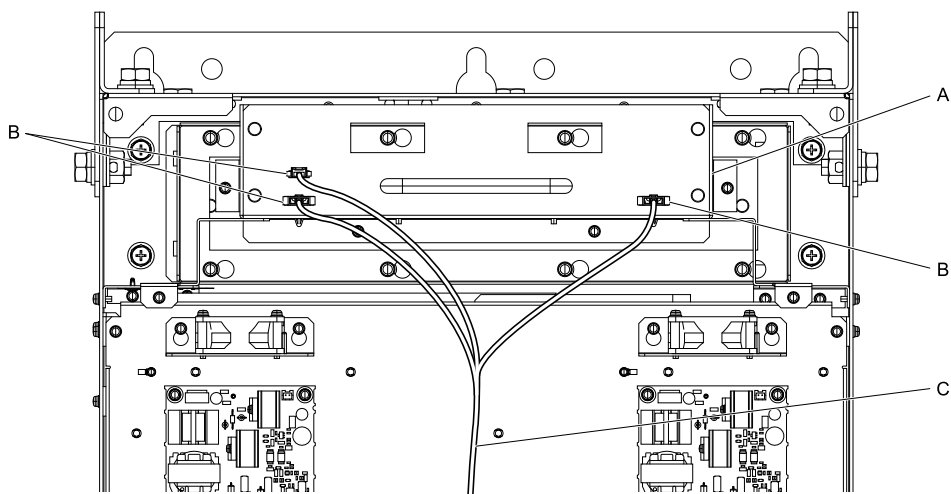

A - Fan unit
B - Fan connector

C - Fan cable

Figure 8.47 Components

3. Loosen the fan unit screws and slide the slide panel to the left.

Note:

To remove the fan unit, it is only necessary to loosen the Screws B.
Remove screws A.

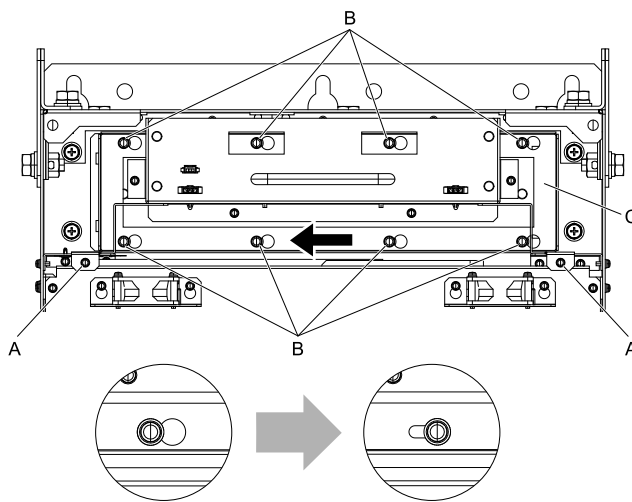

A - Screws A
B - Screws B

C - Slide panel

Figure 8.48 Slide the Slide Panel

4. Remove the fan unit and the slide panel at the same time.

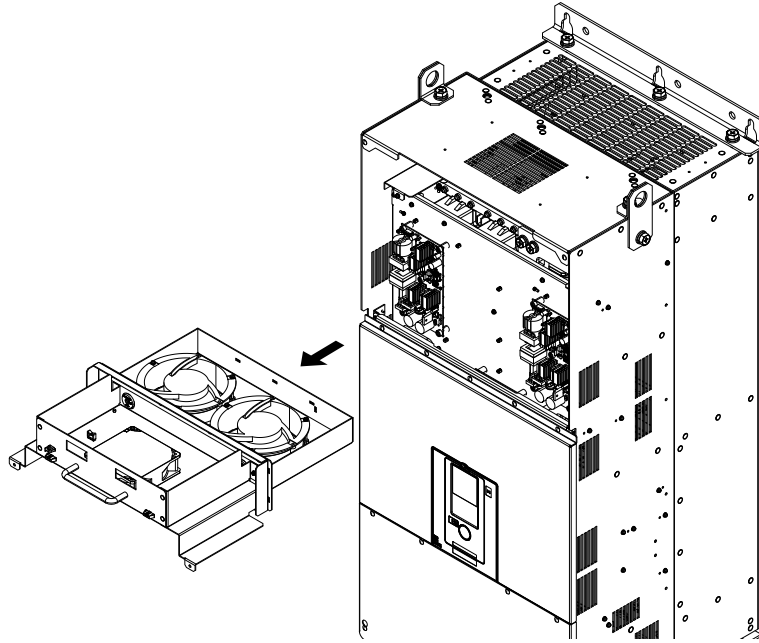
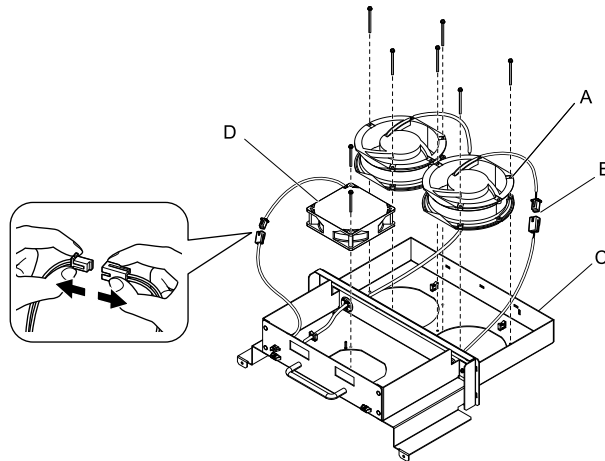

Figure 8.49 Remove the Fan Unit

5. Unplug the power supply connector, remove the screws that safety the cooling fan and circulation fan, and then remove the fans.



A - Cooling fan
B - Relay connector

C - Fan unit base
D - Circulation fan

Figure 8.50 Remove the Cooling Fans

■ Install the Cooling Fans

Reverse the removal procedure to install a cooling fan.

1. Connect the power supply connector.

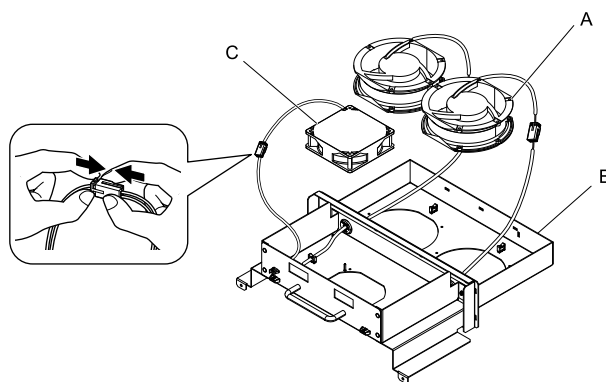

A - Cooling fan
B - Fan unit base

C - Circulation fan

Figure 8.51 Connect the Power Supply Connector

2. Align the pins on the fan unit base with the notches on the fan and put the fan unit base in the fan unit, then use the screws to safety it.
Tighten the M4 screws to a tightening torque of 0.98 N·m to 1.33 N·m (8.67 lb·in to 11.77 lb·in).

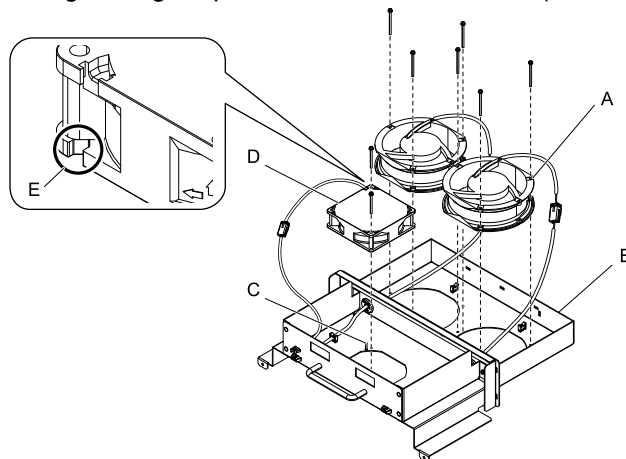

A - Cooling fan
B - Fan unit base
C - Alignment pin on fan unit base

D - Circulation fan
E - Notches

Figure 8.52 Install the Cooling Fans

Note:

When you install the cooling fan, make sure that you do not pinch cables between the cooling fan and the fan unit base.

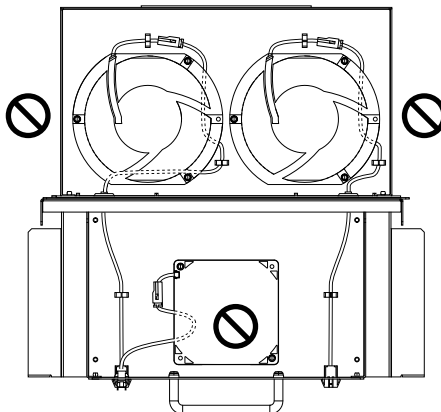

8.4 Replace Cooling Fans and Circulation Fans

- Put the cables in their initial locations.

Note:

Safety the relay cable to the hook.

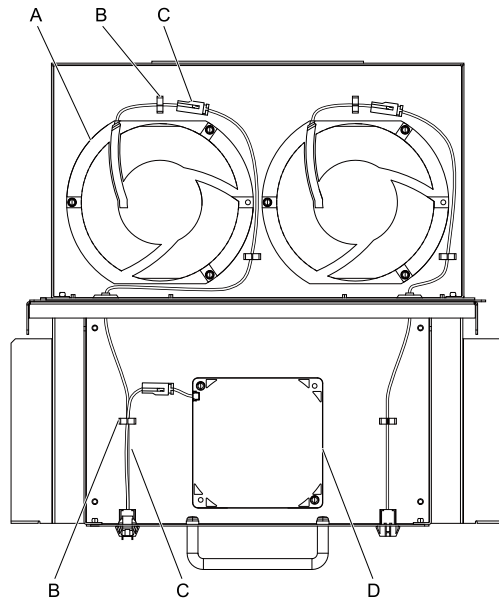

A - Cooling fan
B - Cable hook

C - Relay connector
D - Circulation fan

- Put the fan unit back into its initial position.

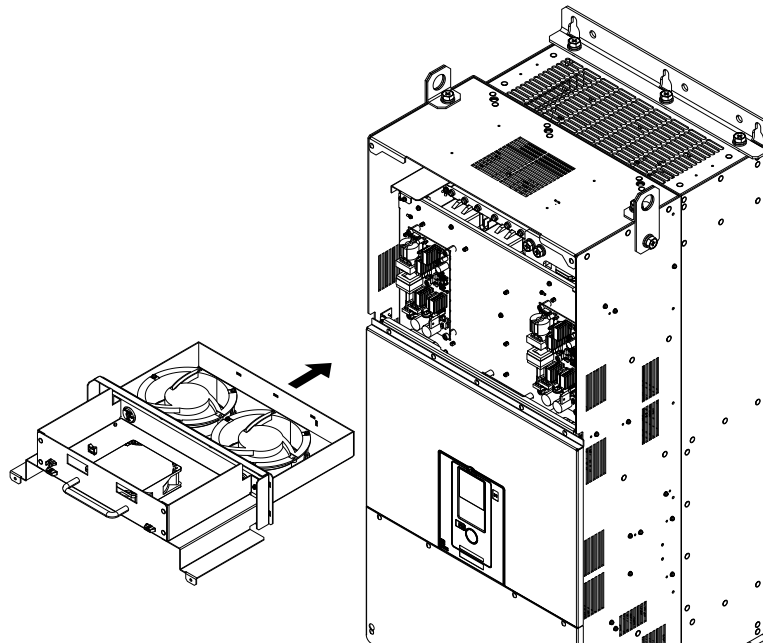

- Slide the fan unit to the right and safety it with mounting screws.
Tighten the screws to a tightening torque of 1.96 N·m to 2.53 N·m (17.35 lb·in to 22.39 lb·in).

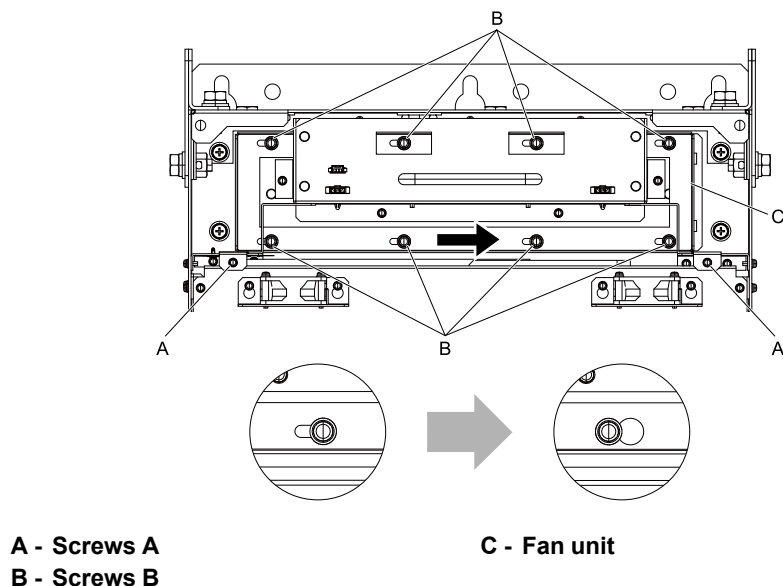

Figure 8.53 Slide the Fan Unit

6. Connect the fan cable to the fan connector.

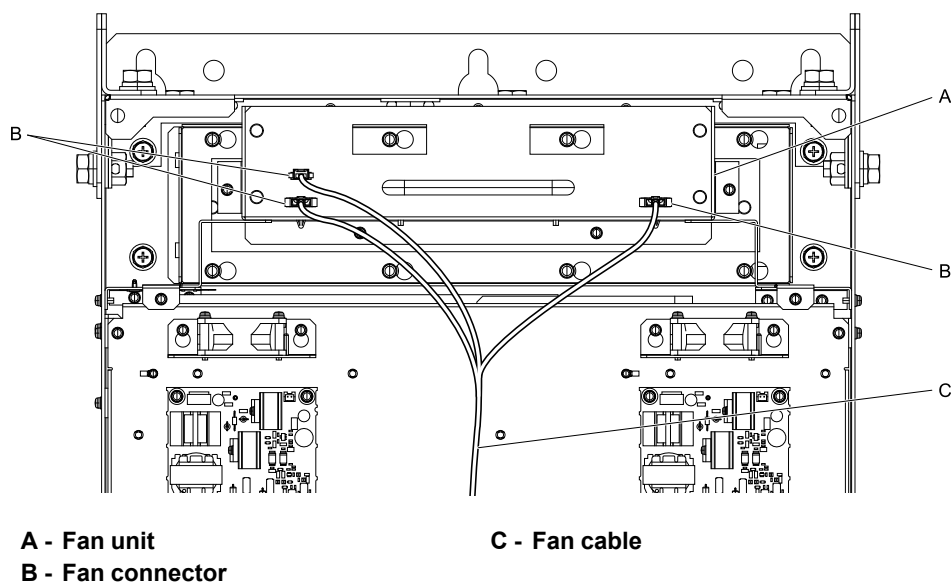

Figure 8.54 Connect Cooling Fan Connectors

7. Reattach the drive cover.
8. Energize the drive and set $\alpha 4-03 = 0$ [Fan Operation Time Setting = 0 h] to reset the cooling fan operation time.

■ Remove the Circuit Board Cooling Fan

Remove the drive cover before you start this procedure.

CAUTION! *Crush Hazard. Loosen the cover screws. Do not fully remove them. If you fully remove the cover screws, the terminal cover can fall and cause moderate injury.*

8.4 Replace Cooling Fans and Circulation Fans

1. Unplug the fan cables from the fan connectors.

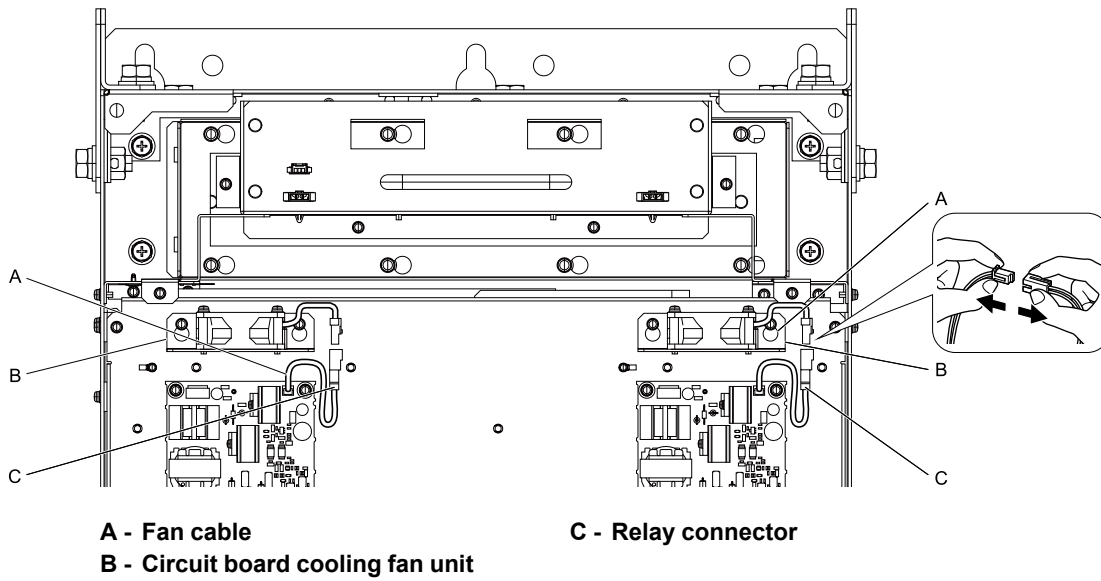
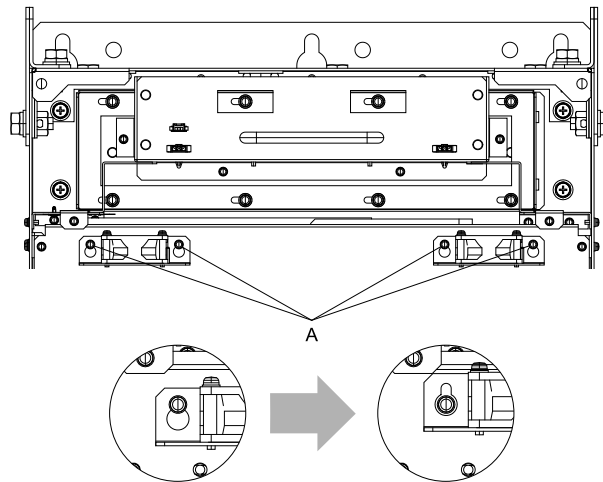

Figure 8.55 Components

2. Loosen the circuit board cooling fan unit screws and slide the circuit board cooling fan unit up.

Note:

To remove the fan unit, it is only necessary to loosen the screws.



A - Screws

Figure 8.56 Slide the Circuit Board Cooling Fan Unit

3. Remove the circuit board cooling fan unit.

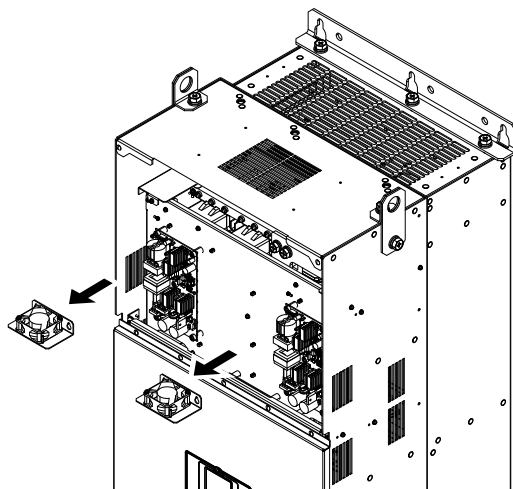
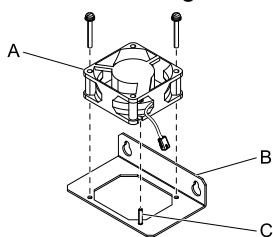

Figure 8.57 Remove the Circuit Board Cooling Fan Unit

4. Remove the screws that safety the circuit board cooling fan and remove the fan.



A - Circuit board cooling fan
B - Fan unit base

C - Alignment pin on fan unit base

Figure 8.58 Remove the Circuit Board Cooling Fan

■ Install the Circuit Board Cooling Fan

Reverse the removal procedure to install a cooling fan.

1. Align the pins on the fan unit base with the notches on the fan and put the circuit board cooling fan in the fan unit, then use the screws to safety the circuit board cooling fan to the fan unit base. Tighten the M4 screws to a tightening torque of 0.98 N·m to 1.33 N·m (8.67 in·lb to 11.77 in·lb).

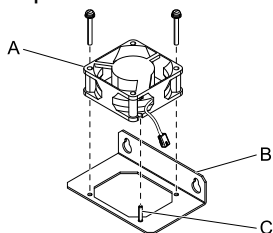

A - Circuit board cooling fan
B - Fan unit base

C - Alignment pin on fan unit base

Figure 8.59 Install the Circuit Board Cooling Fan

8.4 Replace Cooling Fans and Circulation Fans

Note:

When you install the circuit board cooling fan, make sure that you do not pinch cables between the circuit board cooling fan and the fan unit base.

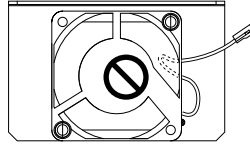

- Put the circuit board cooling fan unit into the specified location and slide it down, then use the screws to safety it to the drive.
Tighten the screws to a tightening torque of 0.98 N·m to 1.33 N·m (8.67 in·lb to 11.77 in·lb).

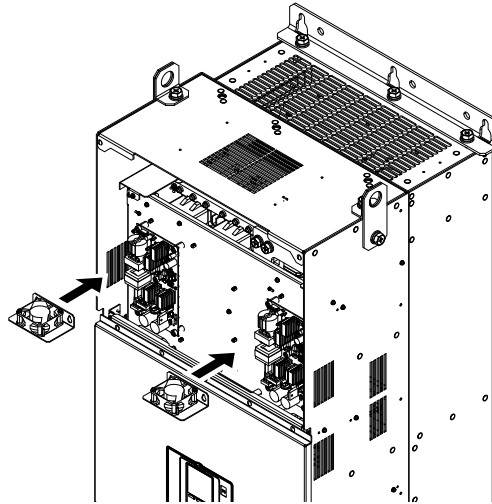

- Connect the fan cable to the fan connector.

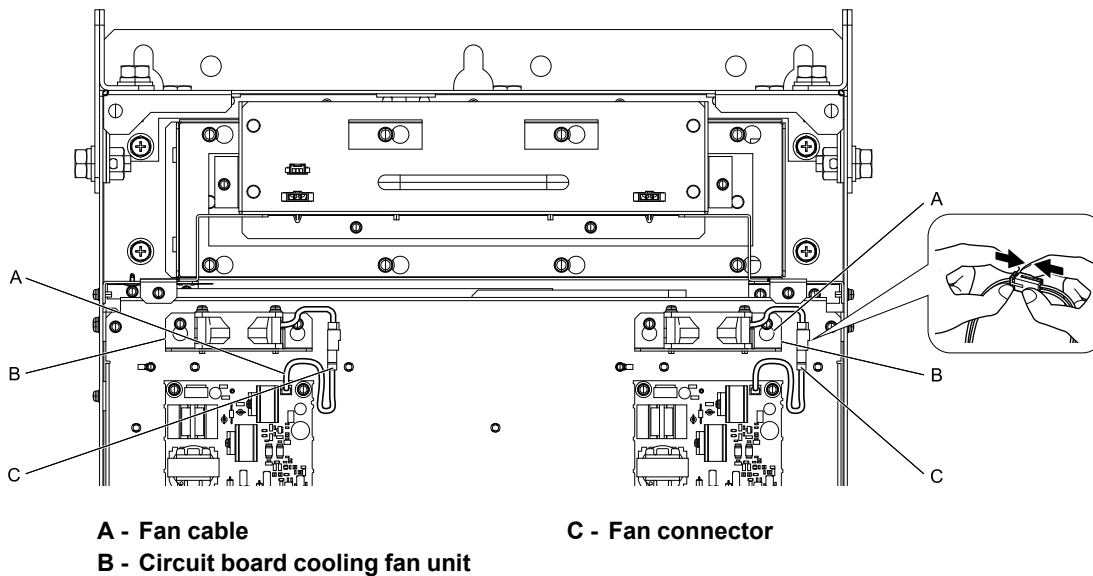

A - Fan cable

B - Circuit board cooling fan unit

C - Fan connector

Figure 8.60 Connect Cooling Fan Connectors

- Install the drive cover.
- Energize the drive and set $o4-03 = 0$ [Fan Operation Time Setting = 0 h] to reset the cooling fan operation time.

◆ Replace Fans (Procedure H)

DANGER! Electrical Shock Hazard. Do not examine, connect, or disconnect wiring on an energized drive. Before servicing, disconnect all power to the equipment and wait for the time specified on the warning label at a minimum. The internal capacitor stays charged after the drive is de-energized. The charge indicator LED extinguishes when the DC bus voltage decreases below 50 Vdc. When all indicators are OFF, remove the covers before measuring for dangerous voltages to make sure that the drive is safe. If you do work on the drive when it is energized, it will cause serious injury or death from electrical shock. The drive has internal capacitors that stay charged after you de-energize the drive.

CAUTION! Burn Hazard. Do not touch a hot drive heatsink. De-energize the drive, wait for a minimum of 15 minutes, then make sure that the heatsink is cool before you replace the cooling fans. If you touch a hot drive heatsink, it can burn you.

NOTICE: Use the instructions in this manual to replace the cooling fans. When you do maintenance on the fans, replace all the fans to increase product life. If you install the fans incorrectly, it can cause damage to the drive.

■ Remove a Fan

1. Remove the drive cover.

CAUTION! Crush Hazard. Loosen the cover screws. Do not fully remove them. If you fully remove the cover screws, the terminal cover can fall and cause moderate injury.

2. Unplug the fan cables from the fan connectors.

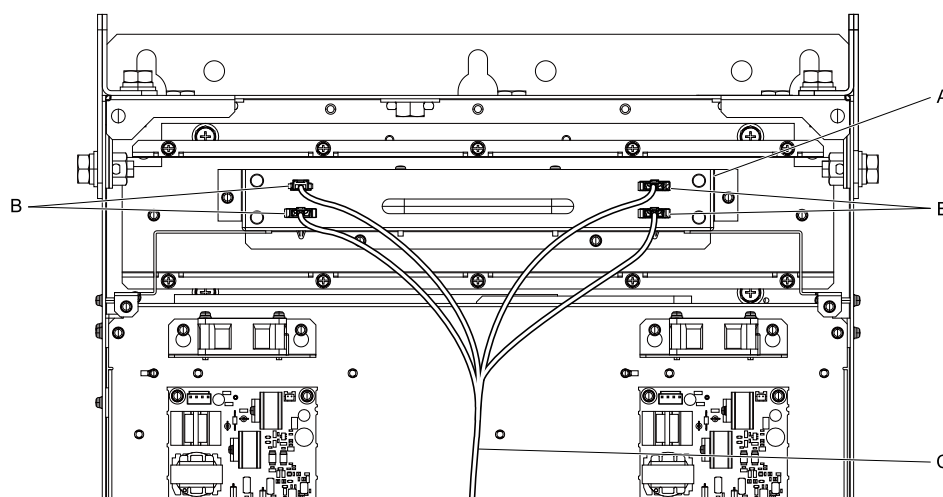

A - Fan unit
B - Fan connector

C - Fan cable

Figure 8.61 Components

3. Loosen the fan unit screws.

Note:

To remove the fan unit, it is only necessary to loosen the Screws B. Remove screws A.

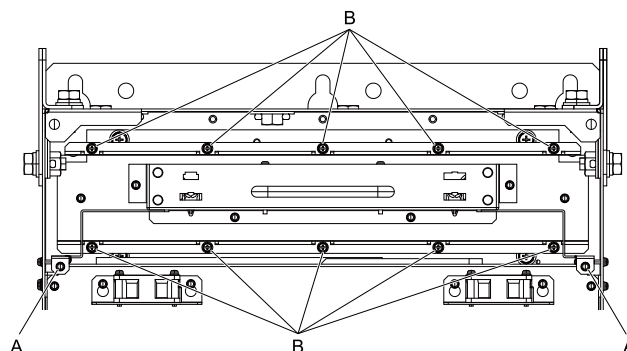

A - Screws A

B - Screws B

Figure 8.62 Loosen the Screws

4. Remove the fan unit.

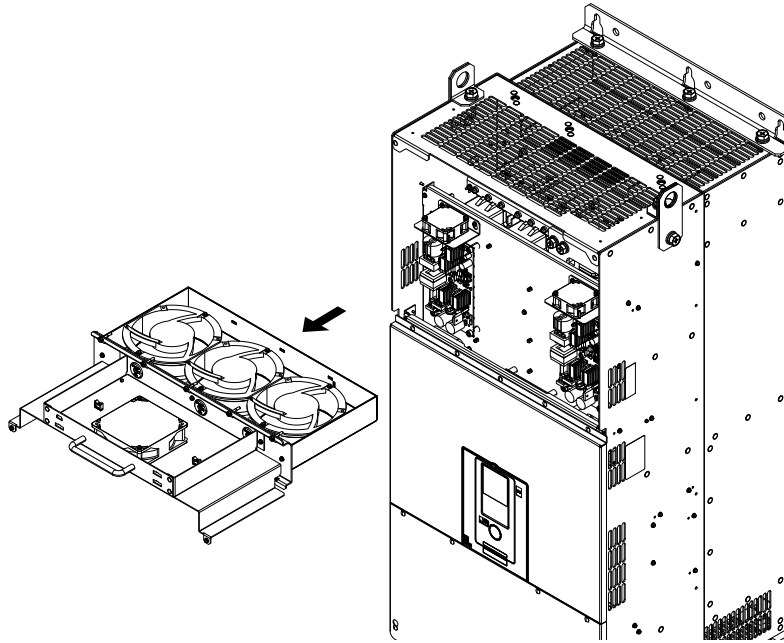
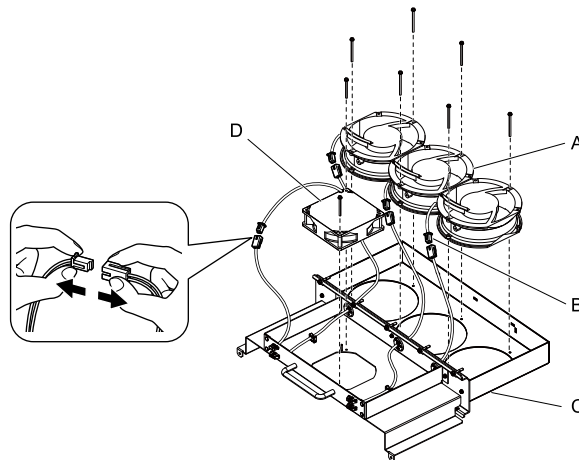

Figure 8.63 Remove the Fan Unit

5. Unplug the power supply connector, remove the screws that safety the cooling fan and circulation fan, and then remove the fans.



A - Cooling fan
B - Relay connector

C - Fan unit base
D - Circulation fan

Figure 8.64 Remove the Cooling Fans

■ Install the Cooling Fans

Reverse the removal procedure to install a cooling fan.

1. Connect the power supply connector.

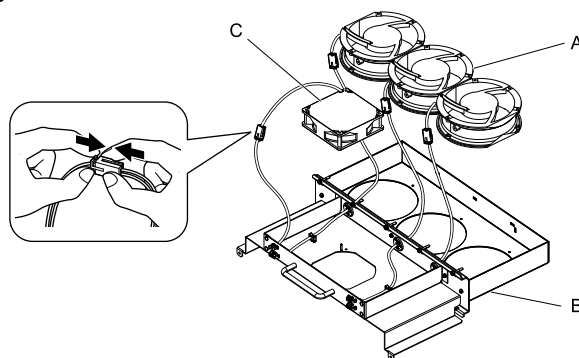

A - Cooling fan
B - Fan unit base

C - Circulation fan

Figure 8.65 Connect the Power Supply Connector

2. Align the pins on the fan unit base with the notches on the fan and put the fan unit base in the fan unit, then use the screws to safety it.

Tighten the M4 screws to a tightening torque of 0.98 N·m to 1.33 N·m (8.67 lb·in to 11.77 lb·in).

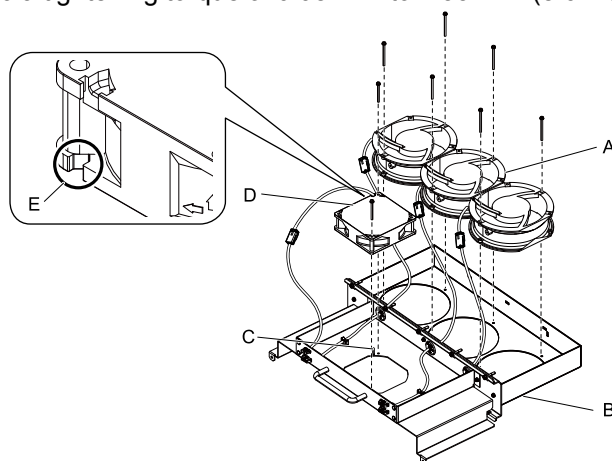

A - Cooling fan
B - Fan unit base
C - Alignment pin on fan unit base

D - Circulation fan
E - Notches

Figure 8.66 Install the Cooling Fans

Note:

When you install the cooling fan, make sure that you do not pinch cables between the cooling fan and the fan unit base or between cooling fans.

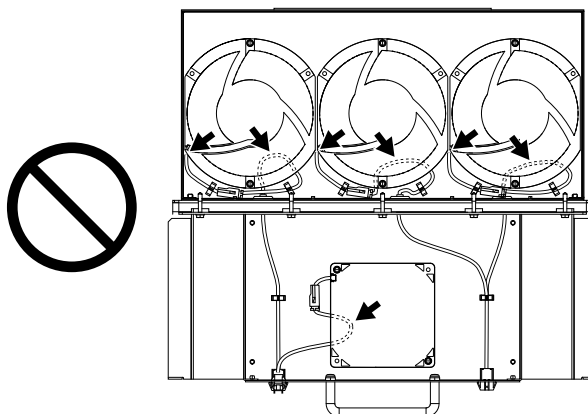

8.4 Replace Cooling Fans and Circulation Fans

- Put the cables in their initial locations.

Note:

Safety the relay cable to the hook.

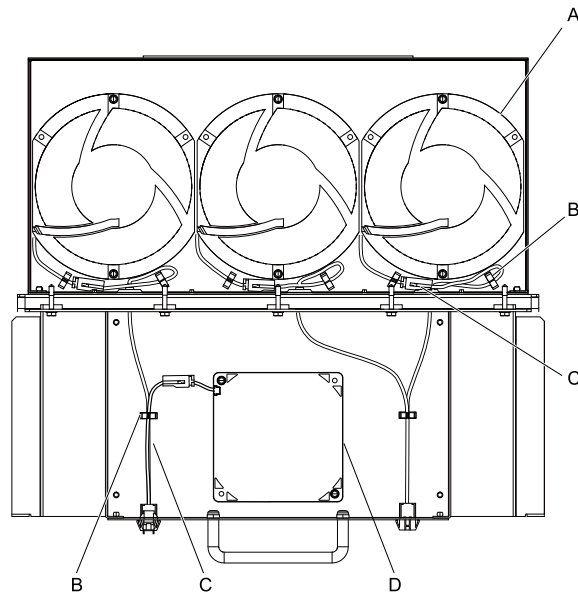

A - Cooling fan

B - Cable hook

C - Relay connector

D - Circulation fan

- Put the fan unit into the specified location and use screws to safety it to the drive.
Tighten the screws to a tightening torque of 1.96 N·m to 2.53 N·m (17.35 lb·in to 22.39 lb·in).

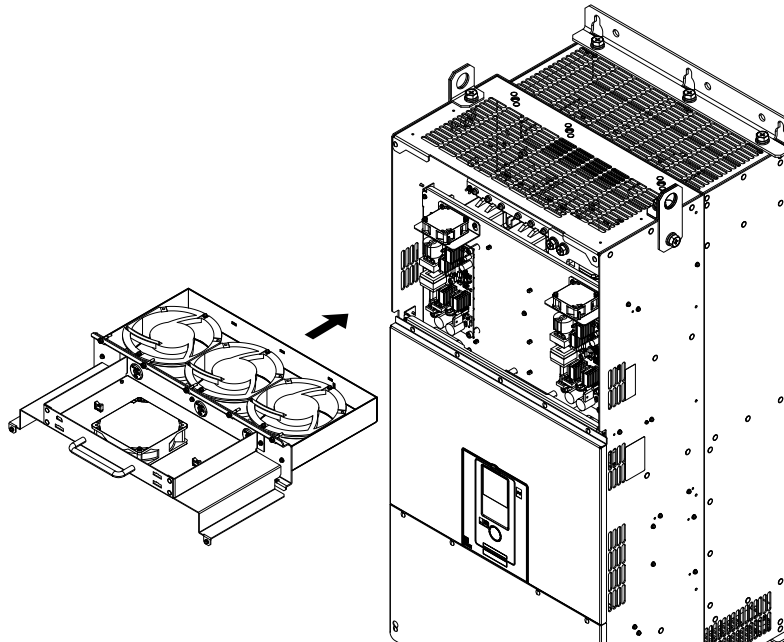

5. Connect the fan cable to the fan connector.

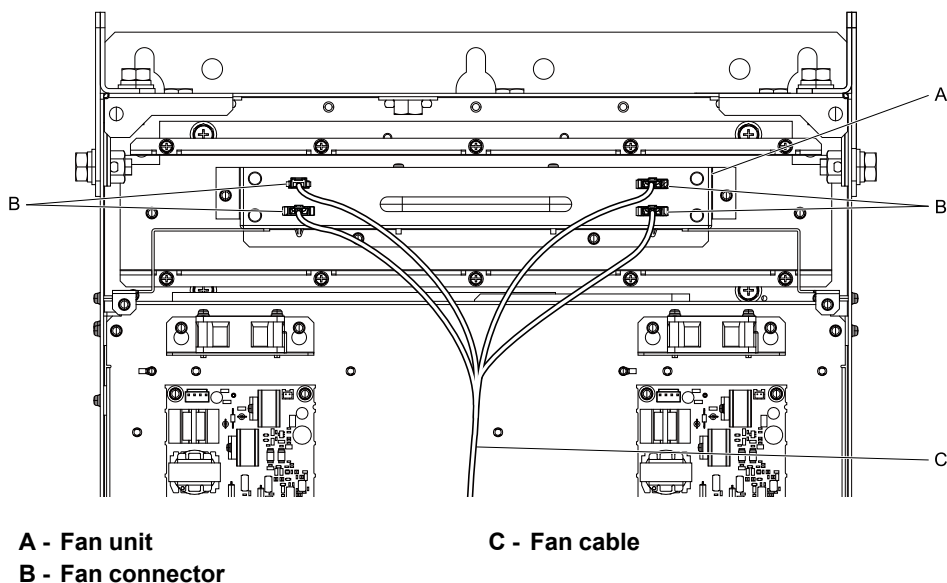

Figure 8.67 Connect Cooling Fan Connectors

6. Install the drive cover.
7. Energize the drive and set $\alpha 4-03 = 0$ [Fan Operation Time Setting = 0 h] to reset the cooling fan operation time.

■ Remove the Circuit Board Cooling Fan

Remove the drive cover before you start this procedure.

CAUTION! Crush Hazard. Loosen the cover screws. Do not fully remove them. If you fully remove the cover screws, the terminal cover can fall and cause moderate injury.

1. Unplug the fan cables from the fan connectors.

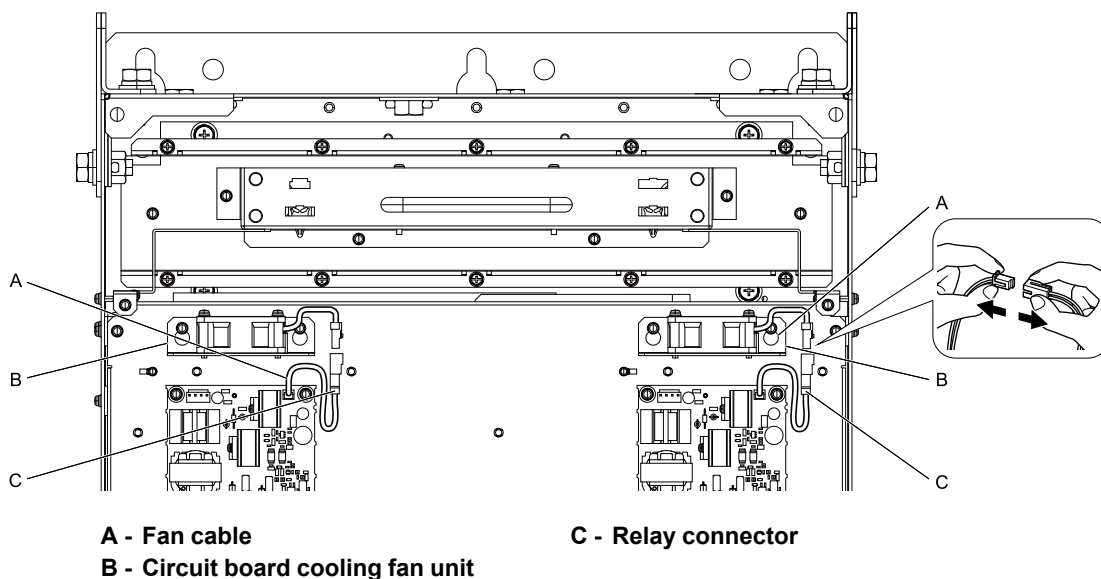
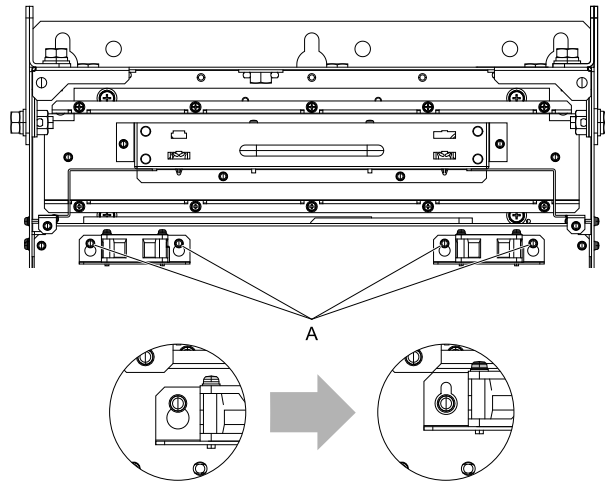

Figure 8.68 Components

2. Loosen the circuit board cooling fan unit screws and slide the circuit board cooling fan unit up.

Note:

To remove the fan unit, it is only necessary to loosen the screws.



A - Screws

Figure 8.69 Slide the Circuit Board Cooling Fan Unit

3. Remove the circuit board cooling fan unit.

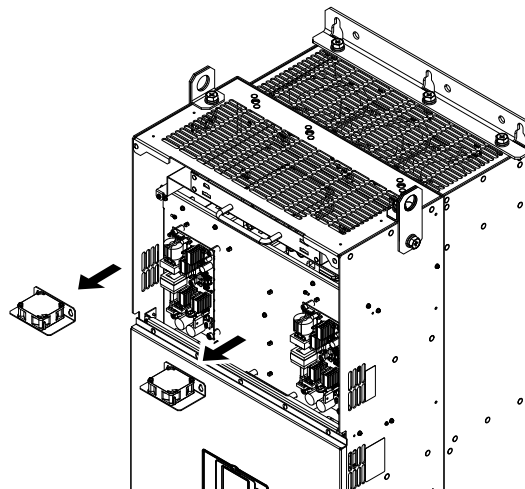
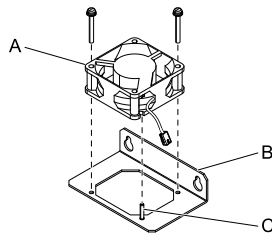

Figure 8.70 Remove the Circuit Board Cooling Fan Unit

4. Remove the screws that safety the circuit board cooling fan and remove the fan.



A - Circuit board cooling fan
B - Fan unit base

C - Alignment pin on fan unit base

Figure 8.71 Remove the Circuit Board Cooling Fan

■ Install the Circuit Board Cooling Fan

Reverse the removal procedure to install a cooling fan.

1. Align the pins on the fan unit base with the notches on the fan and put the circuit board cooling fan in the fan unit, then use the screws to safety the circuit board cooling fan to the fan unit base.
Tighten the M4 screws to a tightening torque of 0.98 N·m to 1.33 N·m (8.67 in·lb to 11.77 in·lb).

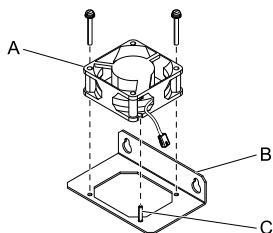

A - Circuit board cooling fan
B - Fan unit base

C - Alignment pin on fan unit base

Figure 8.72 Install the Circuit Board Cooling Fan

Note:

When you install the circuit board cooling fan, make sure that you do not pinch cables between the circuit board cooling fan and the fan unit base.

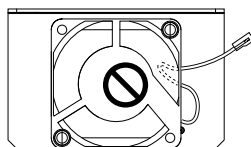

- Put the fan unit into the specified location and use screws to safety it to the drive.
Tighten the screws to a tightening torque of 0.98 N·m to 1.33 N·m (8.67 in·lb to 11.77 in·lb).

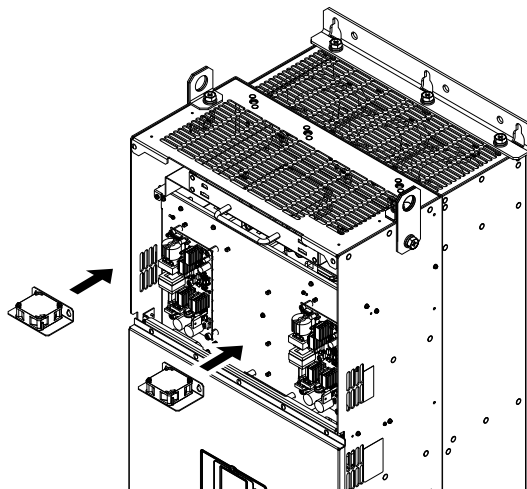

3. Connect the fan cable to the fan connector.

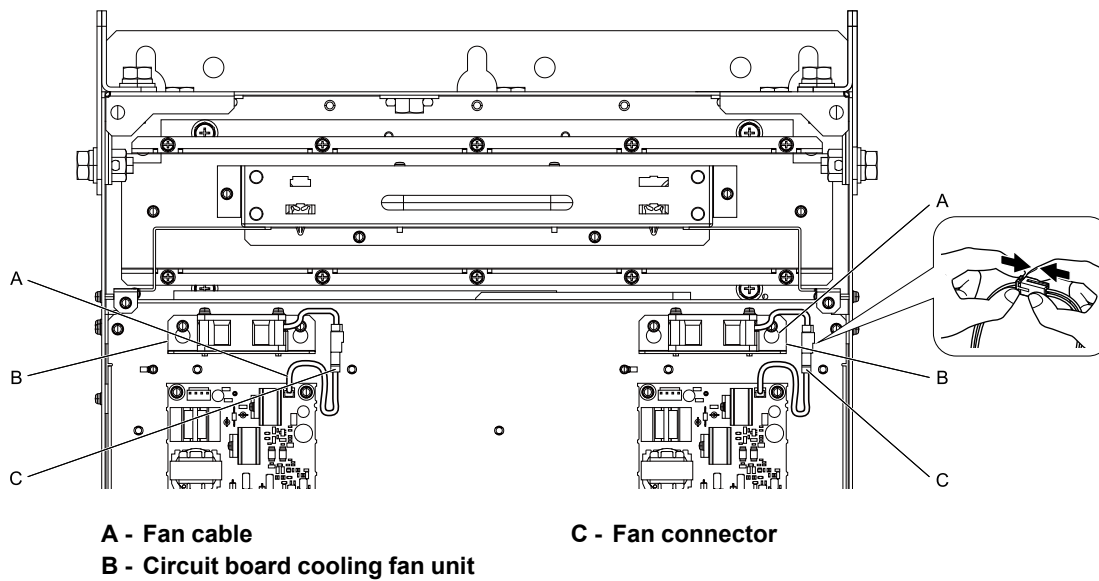

Figure 8.73 Connect Cooling Fan Connectors

4. Install the drive cover.
5. Energize the drive and set $o4-03 = 0$ [*Fan Operation Time Setting = 0 h*] to reset the cooling fan operation time.

8.5 Replace the Drive

◆ About the Control Circuit Terminal Block

You can remove the control circuit terminal block of the drive and install a new terminal block. If there is a failure in the drive, you can use this feature to easily replace the control circuit terminal block.

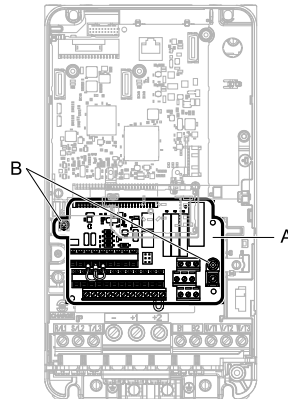

A - Control circuit terminal block

B - Control circuit terminal block fastening screw

Figure 8.74 Control Circuit Terminal Block

◆ Replace the Drive

DANGER! Electrical Shock Hazard. Disconnect all power to the drive and wait for the time specified on the warning label before you remove covers. Check the drive for dangerous voltages before servicing or repair work. If you do work on the drive when it is energized and there is no cover over the electronic circuits, it will cause serious injury or death from electrical shock. The drive has internal capacitors that stay charged after you de-energize the drive.

WARNING! Electrical Shock Hazard. Only let approved personnel install, wire, maintain, examine, replace parts, and repair the drive. If personnel are not approved, it can cause serious injury or death.

DANGER! Electrical Shock Hazard. Do not examine, connect, or disconnect wiring on an energized drive. Before servicing, disconnect all power to the equipment and wait for the time specified on the warning label at a minimum. The internal capacitor stays charged after the drive is de-energized. The charge indicator LED extinguishes when the DC bus voltage decreases below 50 Vdc. When all indicators are OFF, remove the covers before measuring for dangerous voltages to make sure that the drive is safe. If you do work on the drive when it is energized, it will cause serious injury or death from electrical shock. The drive has internal capacitors that stay charged after you de-energize the drive.

NOTICE: Damage to Equipment. When you touch the drive and circuit boards, make sure that you observe correct electrostatic discharge (ESD) procedures. If you do not follow procedures, it can cause ESD damage to the drive circuitry.

■ Notes on Wiring the Main Circuit Terminal Block

Read these notes before you wire the main circuit terminal block.

8.5 Replace the Drive

Note:

- Use UL-Listed, vinyl-coated insulated copper wires for operation with a continuous maximum permitted temperature of 75 °C at 600 V.
- Remove all unwanted objects that are near the terminal block connections.
- Remove the insulation from the connection wires to the wire stripping lengths shown in the manual.
- Do not use bent or crushed wires. Remove the damaged end of the wire before you use it. Incorrect connections can cause death or serious injury from fire.
- Do not solder stranded wire. Soldered wire connections can become loose over time and cause unsatisfactory drive performance.
- If you use stranded wire, make sure that all of the wire strands are in the connection. Also, do not twist the stranded wire too much. Incorrect connections can cause death or serious injury from fire.
- Put the wire all the way into the terminal block. Remove the insulation from the wire to the recommended wire stripping length to fit the wire with insulation in the plastic housing.
- Use a torque driver, torque ratchet, or torque wrench for the screws. A slotted driver or a hex tool will be necessary to wire the screw clamp terminal. Use applicable tools as specified by the recommended conditions in the product manual.
- If you use power tools to tighten the terminal screws, use a low speed setting (300 to 400 r/min). Failure to obey can cause damage to the terminal screws.
- Users can purchase wiring tools from Yaskawa. Contact Yaskawa or your nearest sales representative for more information.
- Wire gauges on existing drive models to be replaced may not match wire gauge ranges on new drives. Contact Yaskawa or your nearest sales representative for more information about the connection procedures.
- Do not tighten the terminal screws at an angle of 5 degrees or more. Failure to obey can cause damage to the terminal screws.

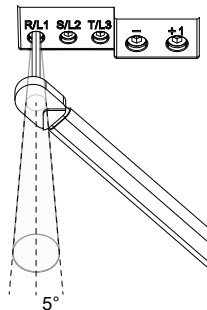

Figure 8.75 Permitted Angle

- Put the bit all the way into the hex socket to tighten the hex socket cap screw.
- When you tighten slotted screws, hold the straight-edge screwdriver perpendicularly to the screw. Make sure that you align the end of the straight-edge screwdriver with the screw groove.

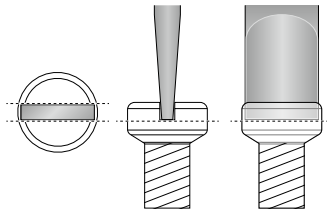
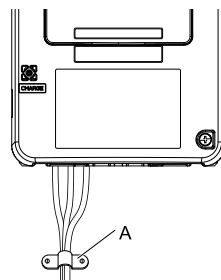

Figure 8.76 Tightening Slotted Screws

- After connecting the wires to the terminal block, lightly pull on the wires to make sure that they do not come out of the terminals.
- Remove the correct section of the wiring cover to make wiring easier.
- Do not let strain on the wiring cause damage. Use a strain relief near the wiring to release the tension. Refer to [Figure 8.77](#) for an example.



A - Cable clamp

Figure 8.77 Strain Relief Example

Table 8.13 Recommended Wiring Tools

Screw Size	Screw Shape	Adapter	Bit		Torque Driver Model (Tightening Torque)	Torque Wrench
			Model	Manufacturer		
M4	Slotted (-)	Bit	SF-BIT-SL 1,0X4,0-70	PHOENIX CONTACT	TSD-M 3NM (1.2 - 3 N·m (10.6 - 26.6 in·lb))	-
M5 *1	Slotted (-)	Bit	F-BIT-SL 1,2X6,5-70	PHOENIX CONTACT	Wire Gauge ≤ 25 mm ² (AWG 10): TSD-M 3NM (1.2 - 3 N·m (10.6 - 26.6 in·lb))	Wire Gauge ≤ 25 mm ² (AWG 10): -
					Wire Gauge ≥ 30 mm ² (AWG 8): -	Wire Gauge ≥ 30 mm ² (AWG 8): 4.1 - 4.5 N·m (36.3 - 39.8 in·lb) *2 *3
M6	Hex socket cap (WAF: 5 mm)	Bit	SF-BIT-HEX 5-50	PHOENIX CONTACT	-	5 - 9 N·m (44.3 - 79.7 in·lb) *2 *3
	Slotted (-)	Bit	SF-BIT-SL 1,2X6,5-70	PHOENIX CONTACT	-	3 - 3.5 N·m (26.6 - 31.0 in·lb) *2 *3
M8	Hex socket cap (WAF: 6 mm)	Bit	SF-BIT-HEX 6-50	PHOENIX CONTACT	-	8 - 12 N·m (70.8 - 106.2 in·lb) *2 *3
M10	Hex socket cap (WAF: 8 mm)	Bit	SF-BIT-HEX 8-50	PHOENIX CONTACT	-	12 - 14 N·m (106.2 - 123.9 in·lb) *2 *3

*1 When wiring drive models 2056 and 4089 and smaller, select the correct tools for the wire gauge.

*2 Use 6.35 mm (0.25 in) bit socket holder.

*3 Use a torque wrench that can apply this torque measurement range.

■ Remove the Control Circuit Terminal Block

Remove the keypad and the drive front cover before doing these steps.

1. Loosen the screws on the control circuit terminal block.

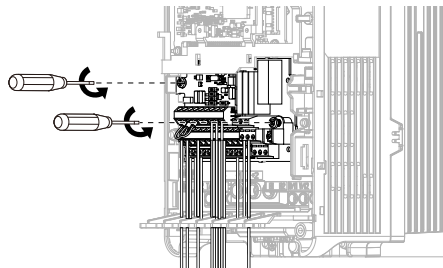

Figure 8.78 Loosen the Screws

2. Slide the wired control circuit terminal block down and remove it.

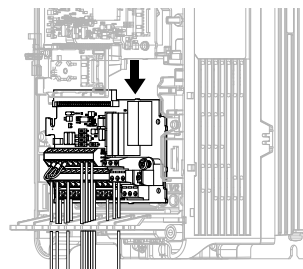

Figure 8.79 Remove the Control Circuit Terminal Block

■ Wire a New Drive

Remove the keypad, front cover, and control circuit terminal block of the new drive. Wire the drive to the main circuit terminal block before you install a wired control circuit terminal block.

8.5 Replace the Drive

1. Pull the wiring cover away from the drive to remove it.

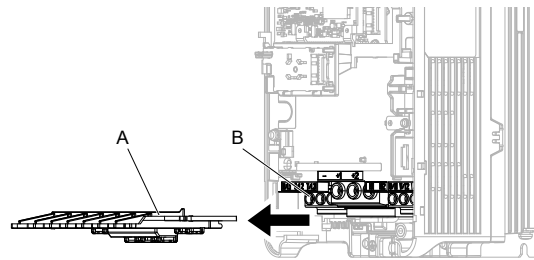

A - Wiring cover

B - Main circuit terminal block

Figure 8.80 Remove the Wiring Cover

2. Loosen the main circuit terminal block screws to fully open the terminal block opening.

Note:

The terminal block openings ship from the factory as fully open.

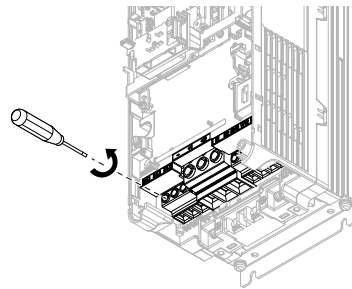

Figure 8.81 Loosen Terminal Block Screws

3. Put a wire with prepared ends into the main circuit terminal block.

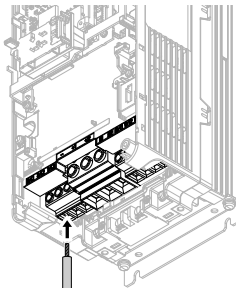

Figure 8.82 Install the Electrical Wire

Note:

If there is a jumper between terminals +1 and +2, loosen the terminal block screws to remove the jumper before you wire to terminals +1 and +2.

4. Tighten the screws to the specified torque.

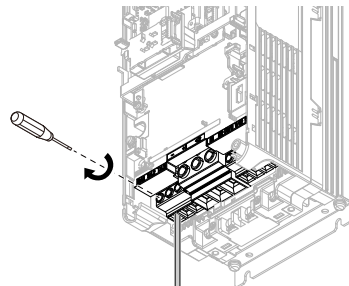
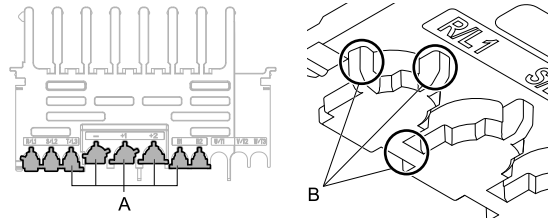

Figure 8.83 Tighten Terminal Block Screws

5. Check the terminal sign that you wired and use a nipper as shown in [Figure 8.84](#) to clip the specified cutaway section of the wiring cover.



A - Cutaway sections

B - Clip here with nippers

Figure 8.84 Clip the Cutaway Section of the Wiring Cover

Note:

- Different drive models have different wiring cover shapes.
- Only clip the section of the wiring cover that applies to the wired terminal. If you clip areas that do not apply to wired terminals, the protective enclosure will not keep its IP20 protective level.
- Be careful when clipping the cutaway section of the wiring cover, as the section may fly out in unpredictable directions.
- Make sure that the clipped section does not cause damage to the wires.
- If you use wires that are not specified by Yaskawa, the protective enclosure could lose its IP20 protective level, although the wiring cover is correct. Contact Yaskawa or your nearest sales representative for more information.

6. Put the wiring cover in its initial position. Put the cables through the holes that you cut out of the wiring cover.

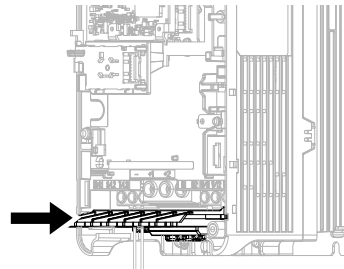
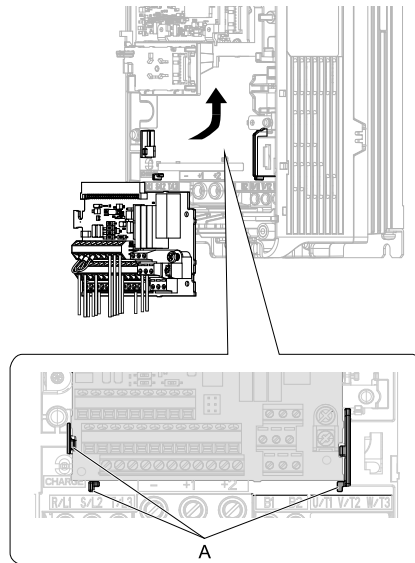

Figure 8.85 Reattach the Wiring Cover

■ Connect the Control Circuit Terminal Block

1. To put a wired control circuit terminal block in the drive, align it with the guides and move it straight up.



A - Guides

Figure 8.86 Put the Terminal Block into the Connector

2. Tighten the M3 screws to a tightening torque of 0.5 N·m to 0.6 N·m (4.4 lb·in. to 5.3 lb·in.).

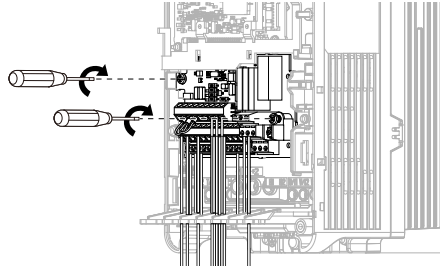

Figure 8.87 Safety the Terminal Block

3. Install the front cover and the keypad to their initial positions.
4. Check *o2-04 [Drive Model (KVA) Selection]*.

Note:

- When you save parameter information in a keypad that you installed before you replaced the terminal block, make sure that you use that keypad to restore the parameter data.
- To reset the performance life monitors for the components, set *o4-01 to o4-13 [Maintenance Period]*.

8.6 Replace the Keypad Battery

When the keypad battery is expired, the date and time go back to the default settings. Use this procedure to replace the battery.

WARNING! Fire Hazard. Handle keypad batteries properly. Do not charge the battery or disassemble the keypad. If the battery explodes, it can cause a fire.

To replace the battery, use a Hitachi Maxell “CR2016 Lithium Manganese Dioxide Lithium Battery” or an equivalent battery with these properties:

- Nominal voltage: 3 V
- Operating temperature range: -20 °C to + 85°C (-4 °F to +185 °F)

WARNING! Fire Hazard. Do not disassemble batteries. Do not expose batteries to heat or fire. If the battery explodes, it can cause a fire.

NOTICE: Damage to Equipment. The keypad battery stays in use after you de-energize the drive. When you will keep the drive de-energized for long periods of time, remove the battery from the keypad. When the expected life of the battery is complete, replace the battery immediately. A dead battery in the keypad can leak and cause damage to the keypad and drive.

The performance life estimate of a new battery is:

- Ambient temperature 20 °C (68 °F): 5 years
- Ambient temperature -10 °C to +50 °C (14 °F to 122 °F): 3.5 years

1. De-energize the drive and remove the keypad.
2. Use a slotted screwdriver or other tool to turn the battery cover counterclockwise and remove the cover.

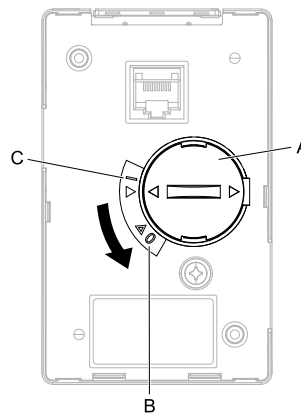

A - Battery cover
B - Opened

C - Closed

Figure 8.88 Remove the Battery Cover

3. Remove the used battery from the keypad.
4. Insert the new battery.

Note:

- The battery cover side is the positive pole. Make sure that the polarity is correct when you put the battery in the keypad.
- Discard the used battery as specified by local regulations.

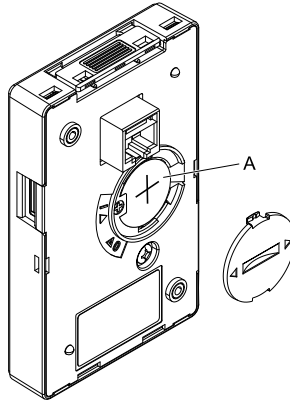

A - Battery

Figure 8.89 Insert the New Battery

5. Put the battery cover on the keypad and use a slotted screwdriver to turn the battery cover clockwise to close it.
6. Install the keypad on the drive.

8.7 Storage Guidelines

The chemicals in the electrolytic capacitors and other electronic parts of the drive change over time. When you store the drive for long periods of time, use the information in this section to help keep the performance life estimates.

◆ Storage Location

- **Temperature and Humidity**
When you store the drive for approximately one month, for example during shipping, you can put the drive in a location where the temperature is $-20\text{ }^{\circ}\text{C}$ to $+70\text{ }^{\circ}\text{C}$ ($-4\text{ }^{\circ}\text{F}$ to $+158\text{ }^{\circ}\text{F}$). Correctly package and store the drive during shipping to prevent vibration and impact damage.
Do not put the drive in direct sunlight or where there will be condensation or ice. Put the drive in a location where the relative humidity is 95% or less.
- **Dust and Oil Mist**
Do not keep the drive locations with dust or oil mist. For example, cement factories and cotton mills.
- **Corrosive Gas**
Do not keep the drive in locations with corrosive gas. For example, chemical plants, refineries, and sewage plants.
- **Salt Damage**
Do not keep the drive in salty locations. For example, locations near the ocean, and salt damage-designated locations.

Do not keep the drive in unsatisfactory locations. Keep all drives in storage rooms that are safe from unsatisfactory elements.

◆ Regular Application of Power

To prevent deterioration of the capacitors, Yaskawa recommends that you apply power to the drive a minimum of one time each year for a minimum of 30 minutes.

If you store the drive for longer than two years and do not apply power, Yaskawa recommends that you use a variable power source and gradually increase the power from 0 V to the rated drive voltage over a period of 2 to 3 minutes. Apply power for a minimum of 1 hour with no load to reform the main circuit electrolytic capacitor. When you operate the drive after you apply power, wire the drive correctly and check for drive faults, overcurrents, motor vibration, motor speed differences, and other defects during operation.

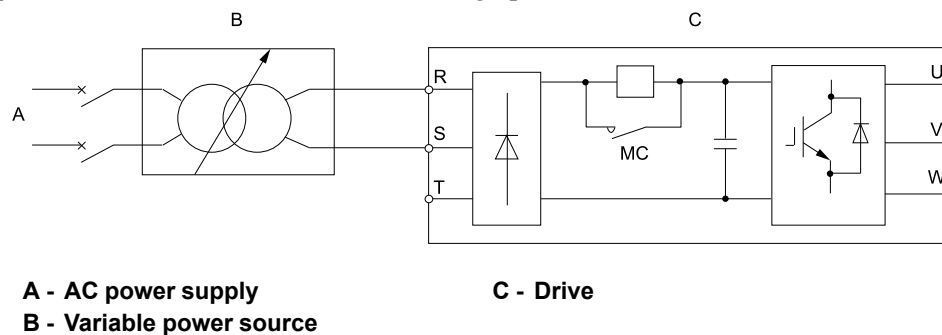

Figure 8.90 Power Distribution Method

Disposal

9.1	Section Safety	428
9.2	Disposal Instructions	429
9.3	WEEE Directive	430

9.1 Section Safety

WARNING

Electrical Shock Hazard

De-energize the drive and wait 5 minutes minimum until the Charge LED turns off. Remove the front cover and terminal cover to do work on wiring, circuit boards, and other parts. Use terminals for their correct function only.

Incorrect wiring, incorrect ground connections, and incorrect repair of protective covers can cause death or serious injury.

Only let approved personnel install, wire, maintain, examine, replace parts, and repair the drive.

If personnel are not approved, it can cause serious injury or death.

Do not wear loose clothing or jewelry when you do work on the drive. Tighten loose clothing and remove all metal objects, for example watches or rings.

Loose clothing can catch on the drive and jewelry can conduct electricity and cause serious injury or death.

Fire Hazard

Handle keypad batteries properly. Do not charge the battery or disassemble the keypad.

If the battery explodes, it can cause a fire.

Do not disassemble batteries. Do not expose batteries to heat or fire.

If the battery explodes, it can cause a fire.

Crush Hazard

Wear eye protection when you do work on the drive.

If you do not use correct safety equipment, it can cause serious injury or death.

Only approved personnel can operate a crane or hoist to move the drive.

If unapproved personnel operate a crane or hoist, it can cause serious injury or death from falling equipment.

Use a crane or hoist to move large drives when necessary.

If you try to move a large drive without a crane or hoist, it can cause serious injury or death.

CAUTION

Crush Hazard

Tighten terminal cover screws and hold the case safely when you move the drive.

If the drive or covers fall, it can cause moderate injury.

NOTICE

Damage to Equipment

The keypad battery stays in use after you de-energize the drive. When you will keep the drive de-energized for long periods of time, remove the battery from the keypad. When the expected life of the battery is complete, replace the battery immediately.

A dead battery in the keypad can leak and cause damage to the keypad and drive.

9.2 Disposal Instructions

Correctly discard the drive, packing material, battery, and microSD card as specified by regional, local, and municipal laws and regulations for this product. (Example: European Waste 16 02 14)

Note:

- Remove the battery and microSD card from the keypad before you discard the drive.
- You cannot recycle the battery. Discard used batteries as specified by the battery manufacturer.
- Customers are responsible for microSD card data protection. PC functions that format and delete the data may not be sufficient to fully erase the microSD card data.
Yaskawa recommends that customers physically destroy the microSD card in a shredder or use data wipe software to fully erase the card.

9.3 WEEE Directive



The wheeled bin symbol on this product, its manual, or its packaging identifies that you must recycle it at the end of its product life.

You must discard the product at an applicable collection point for electrical and electronic equipment (EEE). Do not discard the product with usual waste.

Specifications

10.1	Section Safety	432
10.2	Drive Duty Modes	433
10.3	Model-Specific Specifications (200 V Class).....	434
10.4	Model-Specific Specifications (400 V Class).....	436
10.5	Common Drive Specifications	439
10.6	Drive Watt Loss	443
10.7	Drive Derating	446
10.8	Drive Exterior and Mounting Dimensions.....	452
10.9	Knock-Out Hole Dimensions (IP20/UL Type 1).....	473
10.10	Peripheral Devices and Options.....	478

10.1 Section Safety

 **DANGER**

Do not ignore the safety messages in this manual.

If you ignore the safety messages in this manual, it will cause serious injury or death. The manufacturer is not responsible for injuries or damage to equipment.

10.2 Drive Duty Modes

The drive has two duty modes from which to select for the application: Heavy Duty (HD) and Normal Duty (ND).

- The input power kVA
- The maximum applicable motor output
- The rated input current
- The rated output capacity
- The rated output current

Note:

The reference for the parameter set as a percentage of the drive rated output current is the rated output current of HD/ND.

Refer to [Table 10.1](#) for information about the differences between HD and ND ratings.

Table 10.1 Drive Duty Modes

Duty Rating	C6-01 Setting	Application	Default Carrier Frequency	Overload Tolerance (oL2 [Drive Overload])
Heavy Duty Rating (HD)	0	<ul style="list-style-type: none"> • Extruder • Conveyor • Constant torque or high overload capacity 	2 kHz	150% of the rated output current for 60 seconds The permitted frequency of overload is one time each 10 minutes.
Normal Duty Rating (ND)	1	<ul style="list-style-type: none"> • Fan • Pump • Blower • Variable speed control 	2 kHz Swing-PWM	110% of the rated output current for 60 seconds The permitted frequency of overload is one time each 10 minutes.

10.3 Model-Specific Specifications (200 V Class)

Table 10.2 Ratings (200 V Class)

Model		2004	2006	2008	2010	2012	2018	2021	2030	2042	
Maximum Applicable Motor Output (kW)	HD *1	0.55	0.75	1.1	1.5	2.2	3	3.7	5.5	7.5	
	ND *2	0.75	1.1	1.5	2.2	3	3.7	5.5	7.5	11	
Maximum Applicable Motor Output (HP)	HD *1	3/4	1	1 1/2	2	3	4	5	7 1/2	10	
	ND *2	1	1 1/2	2	3	4	5	7 1/2	10	15	
Input	Rated Input Current (A)	HD (AC)	3.6	4.8	6.7	8.9	12.7	17	20.7	30	40.3
		HD (DC)	4.5	5.9	8.2	10.9	15.6	20.8	25.3	36.8	49.4
		ND (AC)	4.8	6.7	8.9	12.7	17	20.7	30	40.3	58.2
		ND (DC)	5.9	8.2	10.9	15.6	20.8	25.3	36.8	49.4	71.3
Output	Rated Output Current (A)	HD	3.5	5	6.9	8	11	14	17.5	25	33
		ND	4.2	6	8	9.6	12.2	17.5	21	30	42
Power Supply	Input Power (kVA)	HD	1.5	2.0	2.8	3.7	5.3	7.1	8.6	12.5	16.8
		ND	2.0	2.8	3.7	5.3	7.1	8.6	12.5	16.8	21.6

- *1 The maximum applicable motor output complies with 208 V motor ratings as specified in NEC Table 430.250. The rated output current of the drive output amps must be equal to or more than the motor rated current.
- *2 The maximum applicable motor output is based on 4-pole, general-purpose 220 V motor ratings. The rated output current of the drive output amps must be equal to or more than the motor rated current.

Table 10.3 Ratings (200 V Class)

Model		2056	2070	2082	2110	2138	
Maximum Applicable Motor Output (kW)	HD *1	11	15	18.5	22	30	
	ND *2	15	18.5	22	30	37	
Maximum Applicable Motor Output (HP)	HD *1	15	20	25	30	40	
	ND *2	20	25	30	40	50	
Input	Rated Input Current (A)	HD (AC)	58.2	78.4	96	82	111
		HD (DC)	71.3	96	118	100	136
		ND (AC)	78.4	96	114	111	136
		ND (DC)	96	117.6	139	136	166
Output	Rated Output Current (A)	HD	47	60	75	88	115
		ND	56	70	82	110	138
Power Supply	Input Power (kVA)	HD	24.2	32.6	39.9	34.1	46.1
		ND	32.6	39.9	47.4	46.1	56.5

- *1 The maximum applicable motor output complies with 208 V motor ratings as specified in NEC Table 430.250. The rated output current of the drive output amps must be equal to or more than the motor rated current.
- *2 The maximum applicable motor output is based on 4-pole, general-purpose 220 V motor ratings. The rated output current of the drive output amps must be equal to or more than the motor rated current.

Table 10.4 Ratings (200 V Class)

Model		2169	2211	2257	2313	2360	2415
Maximum Applicable Motor Output (kW)	HD *1	37	45	55	75	90	110
	ND *2	45	55	75	90	110	-
Maximum Applicable Motor Output (HP)	HD *1	50	60	75	100	125	150
	ND *2	60	75	100	125	150	-

Model		2169	2211	2257	2313	2360	2415	
Input	Rated Input Current (A)	HD (AC)	136	164	200	271	324	394
		HD (DC)	166	201	245	331	396	482
		ND (AC)	164	200	271	324	394	-
		ND (DC)	201	245	331	396	482	-
Output	Rated Output Current (A)	HD	145	180	215	283	346	415
		ND	169	211	257	313	360	-
Power Supply	Input Power (kVA)	HD	56.5	68.2	83.1	113	135	164
		ND	68.2	83.1	113	135	164	-

- *1 The maximum applicable motor output complies with 208 V motor ratings as specified in NEC Table 430.250. The rated output current of the drive output amps must be equal to or more than the motor rated current.
- *2 The maximum applicable motor output is based on 4-pole, general-purpose 220 V motor ratings. The rated output current of the drive output amps must be equal to or more than the motor rated current.

10.4 Model-Specific Specifications (400 V Class)

Table 10.5 Ratings (400 V Class)

Model		Duty Rating	4002	4004	4005	4007	4009	4012	4018	4023
Maximum Applicable Motor Output (kW) at 380 V Output *1		HD	0.55	1.1	1.5	2.2	3.0	4.0	5.5	7.5
		ND	0.75	1.5	2.2	3.0	4.0	5.5	7.5	11
Maximum Applicable Motor Output (HP) at 460 V Output *2		HD	0.75	1.5	2	3	4	5	7.5	10
		ND	1	2	3	4	5	7.5	10	15
Input	Rated Input Current (A) at 380 V Input	HD (AC)	1.9	3.5	4.7	6.7	8.9	11.7	15.8	21.2
		HD (DC)	2.3	4.3	5.8	8.2	10.9	14.3	19.4	26.0
		ND (AC)	2.5	4.7	6.7	8.9	11.7	15.8	21.2	30.6
		ND (DC)	3.1	5.8	8.2	10.9	14.3	19.4	26.0	37.5
	Rated Input Current (A) at 460 V Input	HD (AC)	1.6	2.9	3.9	5.5	7.4	9.0	13.1	17.5
		HD (DC)	1.9	3.6	4.8	6.8	9.0	11.0	16.0	21.5
		ND (AC)	2.1	3.9	5.5	7.4	9.0	13.1	17.5	25.3
		ND (DC)	2.5	4.8	6.8	9.0	11.0	16.0	21.5	31.0
Output	Rated Output Current (A)	HD	1.8	3.4	4.8	5.5	7.2	9.2	14.8	18
		ND	2.1	4.1	5.4	7.1	8.9	11.9	17.5	23.4
Power Supply	Input Power (kVA) at 380 V Input	HD	1.5	2.8	3.7	5.3	7.1	9.3	13	17
		ND	2.0	3.7	5.3	7.1	9.3	13	17	24
	Input Power (kVA) at 460 V Input	HD	1.3	2.4	3.2	4.6	6.2	7.5	11	15
		ND	1.7	3.2	4.6	6.2	7.5	11	15	21

*1 The maximum applicable motor output complies with 380 V motor ratings as specified in Annex G of IEC 60947-4-1. The rated output current of the drive output amps must be equal to or more than the motor rated current.

*2 The maximum applicable motor output complies with 460 V motor ratings as specified in NEC Table 430.250. The rated output current of the drive output amps must be equal to or more than the motor rated current.

Table 10.6 Ratings (400 V Class)

Model		Duty Rating	4031	4038	4044	4060	4075	4089	4103
Maximum Applicable Motor Output (kW) at 380 V Output *1		HD	11	15	18.5	22	30	37	45
		ND	15	18.5	22	30	37	45	55
Maximum Applicable Motor Output (HP) at 460 V Output *2		HD	15	20	25	30	40	50	60
		ND	20	25	30	40	50	60	75
Input	Rated Input Current (A) at 380 V Input	HD (AC)	30.6	41.3	50.5	43.1	58.3	71.5	86.5
		HD (DC)	37.5	50.5	61.9	52.8	71.4	87.5	106.0
		ND (AC)	41.3	50.5	59.7	58.3	71.5	86.5	105
		ND (DC)	50.5	61.9	73.2	71.4	87.5	106.0	129
	Rated Input Current (A) at 460 V Input	HD (AC)	25.3	34.1	41.7	35.6	48.1	59.0	71.4
		HD (DC)	31.0	41.8	51.1	43.7	59.0	72.3	87.5
		ND (AC)	34.1	41.7	49.4	48.1	59.0	71.4	86.9
		ND (DC)	41.8	51.1	60.4	59.0	72.3	87.5	106.0
Output	Rated Output Current (A)	HD	24	31	39	45	60	75	91
		ND	31	38	44	59.6	74.9	89.2	103

Model		Duty Rating	4031	4038	4044	4060	4075	4089	4103
Power Supply	Input Power (kVA) at 380 V Input	HD	24	33	40	34	46	57	69
		ND	33	40	48	46	57	69	84
	Input Power (kVA) at 460 V Input	HD	21	28	35	30	40	49	59
		ND	28	35	41	40	49	59	72

- *1 The maximum applicable motor output complies with 380 V motor ratings as specified in Annex G of IEC 60947-4-1. The rated output current of the drive output amps must be equal to or more than the motor rated current.
- *2 The maximum applicable motor output complies with 460 V motor ratings as specified in NEC Table 430.250. The rated output current of the drive output amps must be equal to or more than the motor rated current.

Table 10.7 Ratings (400 V Class)

Model		Duty Rating	4140	4168	4208	4250	4302	4371	4414
Maximum Applicable Motor Output (kW) at 380 V Output *1		HD	55	75	90	110	132	160	200
		ND	75	90	110	132	160	200	220
Maximum Applicable Motor Output (HP) at 460 V Output *2		HD	75	100	125	150	200	250	300
		ND	100	125	150	200	250	300	350
Input	Rated Input Current (A) at 380 V Input	HD (AC)	105	142	170	207	248	300	373
		HD (DC)	129	174	209	254	304	367	457
		ND (AC)	142	170	207	248	300	373	410
		ND (DC)	174	209	254	304	367	457	502
	Rated Input Current (A) at 460 V Input	HD (AC)	86.9	118	141	171	232	289	346
		HD (DC)	106.0	144	172	210	284	354	424
		ND (AC)	118	141	171	232	289	346	403
		ND (DC)	144	172	210	284	354	424	494
Output	Rated Output Current (A)	HD	112	150	180	216	260	304	371
		ND	140	168	208	250	302	371	414
Power Supply	Input Power (kVA) at 380 V Input	HD	84	113	135	165	198	239	297
		ND	113	135	165	198	239	297	327
	Input Power (kVA) at 460 V Input	HD	72	98	117	142	193	240	288
		ND	98	117	142	193	240	288	335

- *1 The maximum applicable motor output complies with 380 V motor ratings as specified in Annex G of IEC 60947-4-1. The rated output current of the drive output amps must be equal to or more than the motor rated current.
- *2 The maximum applicable motor output complies with 460 V motor ratings as specified in NEC Table 430.250. The rated output current of the drive output amps must be equal to or more than the motor rated current.

Table 10.8 Ratings (400 V Class)

Model		Duty Rating	4477	4568	4605	4720
Maximum Applicable Motor Output (kW) at 380 V Output *1		HD	220	250	315	315
		ND	250	315	355	370
Maximum Applicable Motor Output (HP) at 460 V Output *2		HD	350	400	450	500
		ND	400	450	500	600

10.4 Model-Specific Specifications (400 V Class)

Model		Duty Rating	4477	4568	4605	4720
Input	Rated Input Current (A) at 380 V Input	HD (AC)	410	465	584	584
		HD (DC)	502	569	715	715
		ND (AC)	465	584	657	684
		ND (DC)	569	715	805	838
	Rated Input Current (A) at 460 V Input	HD (AC)	403	460	516	573
		HD (DC)	494	563	632	702
		ND (AC)	460	516	573	686
		ND (DC)	563	632	702	840
Output	Rated Output Current (A)	HD	414	477	605	605
		ND	477	568	675	720
Power Supply	Input Power (kVA) at 380 V Input	HD	327	370	465	-
		ND	370	465	523	-
	Input Power (kVA) at 460 V Input	HD	335	382	429	476
		ND	382	429	476	570

- *1 The maximum applicable motor output complies with 380 V motor ratings as specified in Annex G of IEC 60947-4-1. The rated output current of the drive output amps must be equal to or more than the motor rated current.
- *2 The maximum applicable motor output complies with 460 V motor ratings as specified in NEC Table 430.250. The rated output current of the drive output amps must be equal to or more than the motor rated current.

10.5 Common Drive Specifications

Note:

- To get the OLV, CLV, and AOLV specifications, do Rotational Auto-Tuning.
- To get the longest product life, install the drive in an environment that meets the necessary specifications.

Table 10.9 Control Characteristics

Item	Specification
Control Methods	<ul style="list-style-type: none"> • V/f Control (V/f) • V/f Control with Encoder (CL-V/f) • Open Loop Vector (OLV) • Closed Loop Vector (CLV) • Advanced Open Loop Vector (AOLV) • PM Open Loop Vector (OLV/PM) • PM Advanced Open Loop Vector (AOLV/PM) • PM Closed Loop Vector (CLV/PM) • EZ Vector Control (EZOLV)
Carrier Frequency	Models 2004 to 2415 and 4002 to 4103: HD: 8 kHz without derating the drive capacity. ND: 2 kHz without derating the drive capacity. Derate the drive capacity to use values to 15 kHz maximum. Models 4140 to 4720: HD: 5 kHz without derating the drive capacity. ND: 2 kHz without derating the drive capacity. Derate the drive capacity to use values to 10 kHz maximum.
Maximum Output Voltage	200 V Class: Three-phase 200 V to 240 V 400 V Class: Three-phase 380 V to 480 V Note: The maximum output voltage is proportional to the input voltage.
Frequency Control Range	<ul style="list-style-type: none"> • AOLV and EZOLV: 0.01 Hz to 120 Hz • CL-V/f, CLV, AOLV/PM, and CLV/PM: 0.01 Hz to 400 Hz • V/f, OLV, and OLV/PM: 0.01 Hz to 590 Hz
Frequency Accuracy (Temperature Fluctuation)	Digital inputs: Within $\pm 0.01\%$ of the maximum output frequency ($-10\text{ }^{\circ}\text{C}$ to $+40\text{ }^{\circ}\text{C}$ ($14\text{ }^{\circ}\text{F}$ to $104\text{ }^{\circ}\text{F}$)) Analog inputs: Within $\pm 0.1\%$ of the maximum output frequency ($25\text{ }^{\circ}\text{C} \pm 10\text{ }^{\circ}\text{C}$ ($77\text{ }^{\circ}\text{F} \pm 18\text{ }^{\circ}\text{F}$))
Frequency Setting Resolution	Digital inputs: 0.01 Hz Analog inputs: 1/2048 of the maximum output frequency (11-bit signed)
Output Frequency Resolution	0.001 Hz
Frequency Setting Signal	Main speed frequency reference: -10 Vdc to $+10\text{ Vdc}$ (20 k Ω), 0 Vdc to 10 Vdc (20 k Ω), 4 mA to 20 mA (250 Ω), 0 mA to 20 mA (250 Ω) Main speed reference: Pulse train input (maximum 32 kHz)
Starting Torque	<ul style="list-style-type: none"> • V/f: 150%/3 Hz • CL-V/f: 150%/3 Hz • OLV: 200%/0.3 Hz • CLV: 200%/0 min⁻¹ (r/min) • AOLV: 200%/0.3 Hz • OLV/PM: 100%/5% speed • AOLV/PM: 200%/0 min⁻¹ (r/min) • CLV/PM: 200%/0 min⁻¹ (r/min) • EZOLV: 100%/1% speed Note: Correctly select the drive and motor capacity for this starting torque in these control methods: <ul style="list-style-type: none"> • OLV • CLV • AOLV • AOLV/PM • CLV/PM

10.5 Common Drive Specifications

Item	Specification
Speed Control Range	<ul style="list-style-type: none"> V/f: 1:40 CL-V/f: 1:40 OLV: 1:200 CLV: 1:1500 AOLV: 1:200 OLV/PM: 1:20 AOLV/PM: 1:100 (when high frequency injection is enabled) CLV/PM: 1:1500 EZOLV: 1:100
Zero Speed Control	Possible in these control methods: <ul style="list-style-type: none"> CLV AOLV/PM CLV/PM
Torque Limits	Parameter settings allow different limits in four quadrants in these control methods: <ul style="list-style-type: none"> OLV CLV AOLV AOLV/PM CLV/PM EZOLV
Accel/Decel Time	0.0 s to 6000.0 s The drive can set four pairs of different acceleration and deceleration times.
Braking Torque	Approximately 20% Approximately 125% with a dynamic braking option <ul style="list-style-type: none"> Short-time average deceleration torque Motor output 0.4/0.75 kW: over 100% Motor output 1.5 kW: over 50% Motor output 2.2 kW and larger: over 20%, Overexcitation Braking/High Slip Braking allow for approximately 40% Continuous regenerative torque: Approximately 20%. Dynamic braking option allows for approximately 125%, 10%ED, 10 s <p>WARNING! <i>Set L3-04 = 0 [Stall Prevention during Decel = Disabled] when you operate the drive with:</i></p> <ul style="list-style-type: none"> <i>a regenerative converter</i> <i>regenerative unit</i> <i>braking unit</i> <i>braking resistor</i> <i>braking resistor unit.</i> <p><i>If you set the parameter incorrectly, the drive can decelerate for too long and cause serious injury or death.</i></p> <p>Note:</p> <ul style="list-style-type: none"> Models 2004 to 2138 and 4002 to 4168 have a braking transistor. Short-time average deceleration torque refers to the torque needed to decelerate the motor (uncoupled from the load) from the rated speed to zero. Motor characteristics can change the actual specifications. Motor characteristics change the continuous regenerative torque and short-time average deceleration torque for motors 2.2 kW and larger.
V/f Characteristics	Select from 15 pre-defined V/f patterns, or a user-set V/f pattern.
Main Control Functions	Torque Control, Droop Control, Speed/Torque Control Switching, Feed Forward Control, Zero Servo Function, Restart After Momentary Power Loss, Speed Search, Overtorque/Undertorque Detection, Torque Limit, 17 Step Speed (max.), Accel/Decel Switch, S-curve Acceleration/Deceleration, 3-wire Sequence, Auto-Tuning (Rotational and Stationary), Dwell Function, Cooling Fan ON/OFF Switch, Slip Compensation, Torque Compensation, Frequency Jump, Upper/Lower Limits for Frequency Reference, DC Injection Braking at Start and Stop, Overexcitation Braking, High Slip Braking, PID Control (with Sleep Function), Energy Saving Control, MEMOBUS/Modbus Communication (RS-485 max, 115.2 kbps), Auto Restart, Application Presets, DriveWorksEZ (customized functions), Removable Terminal Block, Online Tuning, KEB, Overexcitation Deceleration, Inertia (ASR) Tuning, Overvoltage Suppression, High Frequency Injection

Table 10.10 Protection Functions

Item	Specification
Motor Protection	Electronic thermal overload protection
Momentary Overcurrent Protection	Drive stops when the output current is more than 200% of the HD output current.
Overload Protection	Drive stops when the output current is more than these overload tolerances: <ul style="list-style-type: none"> HD: 150% of the rated output current for 60 seconds The permitted frequency of overload is one time each 10 minutes. ND: 110% of the rated output current for 60 seconds The permitted frequency of overload is one time each 10 minutes. <p>Note:</p> <ul style="list-style-type: none"> If output frequency < 6 Hz, the drive can trigger the overload protection function when the output current is in the overload tolerance range. Derating may be necessary for applications that start and stop frequently.
Overvoltage Protection	200 V class: Stops when the DC bus voltage is more than approximately 410 V 400 V class: Stops when the DC bus voltage is more than approximately 820 V

Item	Specification
Undervoltage Protection	200 V class: Stops when the DC bus voltage decreases to less than approximately 190 V 400 V class: Stops when the DC bus voltage decreases to less than approximately 380 V
Momentary Power Loss Ride-thru	Stops when power loss is longer than 15 ms. Continues operation if power loss is shorter than 2 s (depending on parameter settings). Note: • Stop time may be shortened depending on the load and motor speed. • Drive capacity will change the continuous operation time. A Momentary Power Loss Recovery Unit is necessary to continue operation through a 2 s power loss on models 2004 to 2056 and 4002 to 4031.
Heatsink Overheat Protection	Thermistor
Braking Resistor Overheat Protection	Overheat detection for braking resistor (optional ERF-type, 3% ED)
Stall Prevention	Stall prevention is available during acceleration, deceleration, and during run.
Ground Fault Protection	Electronic circuit protection Note: This protection detects ground faults during run. The drive will not provide protection when: • There is a low-resistance ground fault for the motor cable or terminal block • Energizing the drive when there is a ground fault.
DC Bus Charge LED	Charge LED illuminates when DC bus voltage is more than 50 V.
Braking Transistor	Built-in to models 2004 to 2138 and 4002 to 4168
DC Link Choke	Built-in to models 2110 to 2415 and 4060 to 4720

Table 10.11 Environment

Item	Specification
Area of Use	Indoors
Power Supply	Overvoltage Category III
	Permitted Frequency Fluctuation: $\pm 5\%$
	Permitted Voltage Fluctuation: -15% to +10%
	200 V class: • Three-phase AC power supply 200 V to 240 V at 50/60 Hz • DC power supply 270 V to 340 V 400 V class: • Three-phase AC power supply 380 V to 480 V at 50/60 Hz • DC power supply 513 V to 679 V
Ambient Temperature Setting	IP20/UL Open Type/Heatsink External Mounting: -10 °C to +50 °C (14 °F to 122 °F) IP20/UL Type 1: -10 °C to +40 °C (14 °F to 104 °F) IP55/UL Type 12 Heatsink External Mounting; front side: -10°C to +50 °C (14 °F to 122 °F) IP55/UL Type 12 Heatsink External Mounting; back side: -10°C to +40 °C (14 °F to 104 °F) • When installing the drive in an enclosure, use a cooling fan or air conditioner to keep the internal air temperature in the permitted range. • Do not let the drive freeze. • You can use IP20/UL Open Type drives at a maximum of 60 °C (140 °F) when you derate the output current. • You can use IP20/UL Type 1 drives at a maximum of 50 °C (122 °F) when you derate the output current.
Humidity	95% RH or less Do not let condensation form on the drive.
Storage Temperature	-20 °C to +70 °C (-4 °F to +158 °F) (short-term temperature during transportation)
Surrounding Area	Pollution degree 2 or less Install the drive in an area without: • Oil mist, corrosive or flammable gas, or dust • Metal powder, oil, water, or other unwanted materials • Radioactive materials or flammable materials, including wood • Harmful gas or fluids • Salt • Direct sunlight

10.5 Common Drive Specifications

Item	Specification
Altitude	<p>1000 m (3281 ft) maximum</p> <p>Note: Derate the output current by 1% for each 100 m (328 ft) to install the drive in altitudes between 1000 m to 4000 m (3281 ft to 13123 ft). It is not necessary to derate the rated voltage in these conditions:</p> <ul style="list-style-type: none"> • Installing the drive at 2000 m (6562 ft) or lower • Installing the drive between 2000 m to 4000 m (6562 ft to 13123 ft) and grounding the neutral point on the power supply. Contact Yaskawa or your nearest sales representative when not grounding the neutral point.
Vibration	<ul style="list-style-type: none"> • 10 Hz to 20 Hz: 1 G (9.8 m/s², 32.15 ft/s²) • 20 Hz to 55 Hz: 2004 to 2211, 4002 to 4168: 0.6 G (5.9 m/s², 19.36 ft/s²) 2257 to 2415, 4208 to 4720: 0.2 G (2.0 m/s², 6.56 ft/s²)
Installation Orientation	Install the drive vertically for sufficient airflow to cool the drive.

Table 10.12 Standard

Item	Specification
Standard	<ul style="list-style-type: none"> • UL 508C • EN61800-3 • IEC/EN61800-5-1 • Two Safe Disable inputs and one EDM output according to EN ISO 13849-1:2015 (PL e (Cat.3)), IEC/EN61508 SIL3
Protection Design	<p>IP20/UL Open Type IP20/UL Type 1 IP55/UL Type 12 Heatsink External Mounting</p> <p>Note: To change an IP20/UL Open Type drive to an IP20/UL Type 1 drive, install a UL Type 1 kit.</p>

10.6 Drive Watt Loss

◆ 200 V Class

Table 10.13 Drive Watt Loss (Heavy Duty)

Model	Rated Output Current A	Carrier Frequency kHz	Interior Unit Loss W	Cooling Fin Loss W	Total Loss W
2004	3.5	8	35	19	54
2006	5	8	37	26	63
2008	6.9	8	40	36	76
2010	8	8	44	43	87
2012	11	8	50	61	111
2018	14	8	47	82	129
2021	17.5	8	56	105	161
2030	25	8	74	174	248
2042	33	8	88	183	271
2056	47	8	112	267	379
2070	60	8	145	373	518
2082	75	8	179	478	657
2110	88	8	155	563	718
2138	115	8	212	680	892
2169	145	5	275	820	1095
2211	180	5	314	991	1305
2257	215	5	398	1252	1650
2313	283	5	502	1643	2145
2360	346	5	582	1978	2560
2415	415	5	644	2359	3003

Table 10.14 Drive Watt Loss (Normal Duty)

Model	Rated Output Current A	Carrier Frequency kHz	Interior Unit Loss W	Cooling Fin Loss W	Total Loss W
2004	4.2	2	35	18	53
2006	6	2	38	25	63
2008	8	2	42	34	76
2010	9.6	2	49	46	95
2012	12.2	2	56	62	118
2018	17.5	2	53	88	141
2021	21	2	75	125	200
2030	30	2	95	206	301
2042	42	2	129	227	356
2056	56	2	149	302	451
2070	70	2	177	403	580
2082	82	2	202	467	669
2110	110	2	192	631	823
2138	138	2	269	814	1083
2169	169	2	338	941	1279

10.6 Drive Watt Loss

Model	Rated Output Current A	Carrier Frequency kHz	Interior Unit Loss W	Cooling Fin Loss W	Total Loss W
2211	211	2	384	1131	1515
2257	257	2	519	1534	2053
2313	313	2	579	1794	2373
2360	360	2	655	2071	2726
2415	415	2	608	2156	2764

◆ 400 V Class

Table 10.15 Drive Watt Loss (Heavy Duty)

Model	Rated Output Current A	Carrier Frequency kHz	Interior Unit Loss W	Cooling Fin Loss W	Total Loss W
4002	1.8	8	38	15	53
4004	3.4	8	42	28	70
4005	4.8	8	46	37	83
4007	5.5	8	48	45	93
4009	7.2	8	37	61	98
4012	9.2	8	46	82	128
4018	14.8	8	65	140	205
4023	18	8	73	150	223
4031	24	8	101	211	312
4038	31	8	119	272	391
4044	39	8	148	354	502
4060	45	8	126	389	515
4075	60	8	165	527	692
4089	75	8	184	617	801
4103	91	8	237	779	1016
4140	112	5	300	956	1256
4168	150	5	486	1274	1760
4208	180	5	446	1432	1878
4250	216	5	558	1464	2022
4302	260	5	692	2061	2753
4371	304	5	824	2346	3170
4414	371	5	777	2212	2989
4477	414	2	1024	2835	3859
4568	453	2	1183	3329	4512
4605	605	2	1328	3995	5323
4720	605	2	1395	4198	5593

Table 10.16 Drive Watt Loss (Normal Duty)

Model	Rated Output Current A	Carrier Frequency kHz	Interior Unit Loss W	Cooling Fin Loss W	Total Loss W
4002	2.1	2	39	16	55
4004	4.1	2	44	33	77
4005	5.4	2	48	31	79
4007	7.1	2	52	44	96

Model	Rated Output Current A	Carrier Frequency kHz	Interior Unit Loss W	Cooling Fin Loss W	Total Loss W
4009	8.9	2	42	58	100
4012	11.9	2	57	84	141
4018	17.5	2	82	144	226
4023	23.4	2	108	185	293
4031	31	2	138	222	360
4038	38	2	145	270	415
4044	44	2	168	335	503
4060	59.6	2	157	444	601
4075	74.9	2	185	527	712
4089	89.2	2	212	665	877
4103	103	2	264	766	1030
4140	140	2	393	1126	1519
4168	168	2	574	1348	1922
4208	208	2	493	1465	1958
4250	250	2	686	1738	2424
4302	296	2	817	2257	3074
4371	371	2	1022	2553	3575
4414	389	2	873	2422	3295
4477	453	2	1183	3329	4512
4568	568	2	1429	3989	5418
4605	675	2	1526	4572	6098
4720	720	2	1723	5184	6907

10.7 Drive Derating

You must derate the drive capacity to operate the drive above the rated temperature, altitude, and default carrier frequency.

◆ Carrier Frequency Settings and Rated Current Values

Table 10.17, Table 10.19, and Table 10.20 show how the drive rated output current changes when the *C6-02 [Carrier Frequency Selection]* value changes. The output current value changes linearly as the carrier frequency changes. You can use the values from the tables to calculate a frequency that is not shown. When *A1-02 = 4, 6 [Control Method Selection = AOLV, AOLV/PM]*, refer to Table 10.18, Table 10.21, and Table 10.22.

■ 200 V Class

Table 10.17 Carrier Frequency and Rated Current Derating

Model	Rated Current (A)											
	Heavy Duty Rating (HD) Parameter C6-01 = 0						Normal Duty Rating (ND) Parameter C6-01 = 1					
	2 kHz	5 kHz	8 kHz	10 kHz	12.5 kHz	15 kHz	2 kHz	5 kHz	8 kHz	10 kHz	12.5 kHz	15 kHz
2004	3.5	3.5	3.5	3.4	3.2	3.06	4.2	4.0	3.6	3.4	3.1	2.77
2006	5.0	5.0	5.0	4.8	4.6	4.3	6	5.6	5	4.6	4.1	3.6
2008	6.9	6.9	6.9	6.5	5.9	5.4	8	7.6	6.9	6.5	5.9	5.4
2010	8.0	8.0	8.0	7.4	6.6	5.8	9.6	9.0	8	7.4	6.6	5.8
2012	11.0	11.0	11.0	10.4	9.6	8.8	12	11.7	11	10.5	9.9	9.3
2018	14.0	14.0	14.0	12.6	10.8	9.1	17.5	16.1	14	12.6	10.8	9.1
2021	17.5	17.5	17.5	16.1	14.3	12.6	21	19.6	17	16.1	14.3	12.5
2030	25.0	25.0	25.0	23.0	20.5	18.0	30	28.0	25	23.0	20.5	18.0
2042	33.0	33.0	33.0	29.3	24.8	20.2	42	38.4	33	29.4	24.9	20.4
2056	47.0	47.0	47.0	43.4	38.9	34.4	56	52.4	47	43.4	38.9	34.4
2070	60.0	60.0	60.0	56.0	51.0	46	70	66.0	60	56.0	51.0	46.0
2082	75.0	75.0	75.0	68.6	60.5	53	82	82.0	75	68.8	61.0	53.1
2110	88.0	88.0	88.0	80.5	71.0	62	110	102.7	92	84.3	75.2	66.0
2138	115.0	115.0	115.0	105.1	92.8	81	138	128.8	115	105.8	94.3	82.8
2169	145.0	145.0	125.2	112.0	-	-	169	152.7	128.3	112.0	-	-
2211	180.0	180.0	155.2	138.6	-	-	211	190.2	158.9	138.1	-	-
2257	215.0	215.0	184.8	164.7	-	-	257	230.4	190.5	163.9	-	-
2313	283.0	283.0	249.0	226.4	-	-	313	288.5	251.7	227.1	-	-
2360	346.0	346.0	294.3	259.8	-	-	360	330.8	287.6	258.8	-	-
2415	415.0	415.0	365.2	332.0	-	-	-	-	-	-	-	-

Table 10.18 AOLV , AOLV/PM Carrier Frequency and Rated Current Derating

Model	Rated Current (A)											
	Heavy Duty Rating (HD) ^{*/} Parameter C6-01 = 0						Normal Duty Rating (ND) ^{*/} Parameter C6-01 = 1					
	2 kHz (2 kHz)	4 kHz (-)	6 kHz (5 kHz)	8 kHz (8 kHz)	10 kHz (10 kHz)	12 kHz (12.5 kHz)	2 kHz (2 kHz)	4 kHz (-)	6 kHz (5 kHz)	8 kHz (8 kHz)	10 kHz (10 kHz)	12 kHz (12.5 kHz)
2004	3.5	3.5	3.4	3.2	3.1	2.9	4.2	3.8	3.5	3.1	2.8	2.4
2006	5.0	5.0	4.9	4.6	4.3	4.1	6.0	5.4	4.8	4.2	3.6	3.0
2008	6.9	6.9	6.7	6.0	5.4	4.7	8.0	7.3	6.7	6.0	5.4	4.7

Model	Rated Current (A)											
	Heavy Duty Rating (HD) ^{*1} Parameter C6-01 = 0						Normal Duty Rating (ND) ^{*1} Parameter C6-01 = 1					
	2 kHz (2 kHz)	4 kHz (-)	6 kHz (5 kHz)	8 kHz (8 kHz)	10 kHz (10 kHz)	12 kHz (12.5 kHz)	2 kHz (2 kHz)	4 kHz (-)	6 kHz (5 kHz)	8 kHz (8 kHz)	10 kHz (10 kHz)	12 kHz (12.5 kHz)
2010	8.0	8.0	7.7	6.7	5.8	4.8	9.6	8.6	7.7	6.7	5.8	4.8
2012	11.0	11.0	10.7	9.8	8.8	7.9	12.2	11.5	10.7	10.0	9.3	8.6
2018	14.0	14.0	13.3	11.2	9.1	6.9	17.5	15.4	13.3	11.2	9.1	6.9
2021	17.5	17.5	16.8	14.7	12.6	10.4	21.0	18.9	16.8	14.6	12.5	10.4
2030	25.0	25.0	24.0	21.0	18.0	15.0	30.0	27.0	24.0	21.0	18.0	15.0
2042	33.0	33.0	31.2	25.7	20.2	14.7	42.0	36.6	31.2	25.8	20.4	15.0
2056	47.0	47.0	45.2	39.8	34.4	29.0	56.0	50.6	45.2	39.8	34.4	29.0
2070	60.0	60.0	58.0	52.0	46.0	40.0	70.0	64.0	58.0	52.0	46.0	40.0
2082	75.0	75.0	71.8	62.1	52.5	42.9	82.0	81.4	72.0	62.6	53.1	43.7
2110	88.0	88.0	84.2	72.9	61.6	50.3	110.0	99.0	88.0	77.0	66.0	55.0
2138	115.0	115.0	110.1	95.3	80.5	65.7	138.0	124.2	110.4	96.6	82.8	69.0
2169	145.0	138.4	118.6	98.8	78.9	-	169.0	144.6	120.1	95.7	71.2	-
2211	180.0	171.7	146.9	122.0	97.2	-	211.0	179.7	148.5	117.2	86.0	-
2257	215.0	204.9	174.7	144.5	114.3	-	257.0	217.1	177.2	137.3	97.4	-
2313	283.0	271.7	237.7	203.8	169.8	-	313.0	276.2	239.4	202.6	165.8	-
2360	346.0	328.8	277.0	225.3	173.6	-	359.6	316.4	273.2	230.0	186.8	-
2415	415.0	398.4	348.6	298.8	249.0	-	-	-	-	-	-	-

*1 The upper values are for $A1-02 = 6$ [Control Method Selection = AOLV/PM]. The values in parenthesis are for $A1-02 = 4$ [ALOV].

■ 400 V Class

Table 10.19 Carrier Frequency and Rated Current Derating (400 V Output Applications)

Model	Rated Current (A)											
	Heavy Duty Rating (HD) Parameter C6-01 = 0						Normal Duty Rating (ND) Parameter C6-01 = 1					
	2 kHz	5 kHz	8 kHz	10 kHz	12.5 kHz	15 kHz	2 kHz	5 kHz	8 kHz	10 kHz	12.5 kHz	15 kHz
4002	1.8	1.8	1.8	1.6	1.3	1.0	2.1	2.0	1.8	1.7	1.5	1.4
4004	3.4	3.4	3.4	2.9	2.3	1.7	4.1	3.8	3.4	3.1	2.8	2.4
4005	4.8	4.8	4.8	4.3	3.7	3.0	5.4	5.2	4.8	4.6	4.3	3.9
4007	5.5	5.5	5.5	4.9	4.1	3.2	7.1	6.5	5.5	4.8	4.0	3.2
4009	7.2	7.2	7.2	6.5	5.6	4.8	8.9	8.2	7.2	6.5	5.6	4.8
4012	9.2	9.2	9.2	8.1	6.8	5.4	11.9	10.8	9.2	8.1	6.7	5.4
4018	14.8	14.8	14.8	13.1	11.0	8.9	17.5	17.3	14.8	13.1	11.0	8.9
4023	18.0	18.0	18.0	15.9	13.4	10.8	23	21.5	18.3	16.2	13.6	11.0
4031	24.0	24.0	24.0	21.2	17.7	14.1	31	28.2	24.0	21.1	17.6	14.1
4038	31.0	31.0	31.0	27.5	23.0	18.6	38	36.3	31.0	27.5	23.0	18.6
4044	39.0	39.0	39.0	34.5	29.0	23.4	44	43.6	37.5	33.5	28.4	23.4
4060	45.0	45.0	45.0	39.1	31.8	24.4	60	53.7	44.9	39.1	31.7	24
4075	60.0	60.0	60.0	53.1	44.6	36.0	75	73.8	62.9	55.6	46.5	37
4089	75.0	75.0	75.0	66.4	55.7	45.0	89	88.8	75.8	67.2	56.4	46
4103	91.0	91.0	91.0	80.6	67.6	54.6	103	103.0	90.3	80.1	67.3	55
4140	112.0	112.0	91.8	78.4	-	-	140	122.8	96.7	79	-	-

10.7 Drive Derating

Model	Rated Current (A)											
	Heavy Duty Rating (HD) Parameter C6-01 = 0						Normal Duty Rating (ND) Parameter C6-01 = 1					
	2 kHz	5 kHz	8 kHz	10 kHz	12.5 kHz	15 kHz	2 kHz	5 kHz	8 kHz	10 kHz	12.5 kHz	15 kHz
4168	150.0	150.0	123.0	105.0	-	-	168	150.5	124.4	107	-	-
4208	180.0	180.0	147.6	126.0	-	-	208	179.7	137.2	109	-	-
4250	216.0	216.0	177.1	151.2	-	-	250	221.8	179.4	151	-	-
4302	260.0	260.0	213.2	182.0	-	-	296	263.4	214.6	182	-	-
4371	304.0	304.0	249.3	212.8	-	-	371	327.2	261.6	218	-	-
4414	371.0	371.0	304.2	259.7	-	-	389	348	286.3	245	-	-
4477	389.0	324.8	-	-	-	-	453	349	-	-	-	-
4568	453.0	378.3	-	-	-	-	568	437	-	-	-	-
4605	605.0	505.2	-	-	-	-	675	529	-	-	-	-
4720	605.0	505.2	-	-	-	-	675	529	-	-	-	-

Table 10.20 Carrier Frequency and Rated Current Derating (≥ 460 V)

Model	Rated Current (A)											
	Heavy Duty Rating (HD) Parameter C6-01 = 0						Normal Duty Rating (ND) Parameter C6-01 = 1					
	2 kHz	5 kHz	8 kHz	10 kHz	12.5 kHz	15 kHz	2 kHz	5 kHz	8 kHz	10 kHz	12.5 kHz	15 kHz
4002	2.1	1.9	1.6	1.4	1.1	0.9	2.1	2.0	1.8	1.7	1.5	1.4
4004	3.0	3.0	3.0	2.6	2.0	1.5	3.4	3.2	2.8	2.6	2.3	2.0
4005	4.3	3.9	3.4	3.0	2.6	2.2	4.8	4.6	4.3	4.0	3.8	3.5
4007	6.2	5.6	4.8	4.2	3.5	2.8	6.9	6.3	5.3	4.7	3.9	3.2
4009	8.6	7.9	6.9	6.2	5.4	4.6	7.6	7.0	6.1	5.5	4.8	4.1
4012	9.8	8.9	7.6	6.7	5.6	4.5	11.0	10.0	8.5	7.5	6.2	5.0
4018	14.1	12.9	11.0	9.7	8.2	6.6	15.2	13.9	11.8	10.5	8.8	7.1
4023	18.0	16.4	14.0	12.4	10.4	8.4	21	19.3	16.4	14.6	12.2	9.9
4031	27.2	24.7	21.0	18.5	15.4	12.4	27	24.5	20.9	18.4	15.4	12.3
4038	34.7	31.6	27.0	23.9	20.1	16.2	34	32.5	27.7	24.6	20.6	16.6
4044	34.0	34.0	34.0	30.1	25.3	20.4	40	39.6	34.1	30.5	25.9	21.3
4060	40.0	40.0	40.0	34.8	28.3	21.7	52	46.9	39.2	34.1	27.7	21
4075	52.0	52.0	52.0	46.1	38.6	31.2	65	64.1	54.6	48.3	40.4	33
4089	65.0	65.0	65.0	57.6	48.3	39.0	77	76.6	65.5	58.0	48.7	39
4103	77.0	77.0	77.0	68.2	57.2	46.2	96	96.0	84.1	74.6	62.8	51
4140	96.0	96.0	78.7	67.2	-	-	124	108.7	85.7	70	-	-
4168	124.0	124.0	101.7	86.8	-	-	156	139.8	115.5	99	-	-
4208	156.0	156.0	127.9	109.2	-	-	180	155.5	118.7	94	-	-
4250	180.0	180.0	147.6	126.0	-	-	240	212.9	172.3	145	-	-
4302	240.0	240.0	196.8	168.0	-	-	302	268.8	218.9	186	-	-
4371	302.0	302.0	247.6	211.4	-	-	361	318.5	254.7	212	-	-
4414	361.0	361.0	296.0	252.7	-	-	414	370	303.3	259	-	-
4477	414.0	345.0	-	-	-	-	477	367	-	-	-	-
4568	477.0	397.5	-	-	-	-	515	397	-	-	-	-
4605	515.0	429.2	-	-	-	-	605	473	-	-	-	-
4720	605.0	504.2	-	-	-	-	720	563	-	-	-	-

Table 10.21 AOLV/PM Carrier Frequency and Rated Current Derating (400 V Output Applications)

Model	Rated Current (A)											
	Heavy Duty Rating (HD) ^{*/} Parameter C6-01 = 0						Normal Duty Rating (ND) ^{*/} Parameter C6-01 = 1					
	2 kHz (2 kHz)	4 kHz (-)	6 kHz (5 kHz)	8 kHz (8 kHz)	10 kHz (10 kHz)	12 kHz (12.5 kHz)	2 kHz (2 kHz)	4 kHz (-)	6 kHz (5 kHz)	8 kHz (8 kHz)	10 kHz (10 kHz)	12 kHz (12.5 kHz)
4002	1.8	1.8	1.7	1.3	1.0	0.6	2.1	1.9	1.7	1.6	1.4	1.2
4004	3.4	3.4	3.2	2.4	1.7	1.0	4.1	3.7	3.3	2.8	2.4	2.0
4005	4.8	4.8	4.5	3.8	3.0	2.3	5.4	5.0	4.7	4.3	3.9	3.6
4007	5.5	5.5	5.2	4.2	3.2	2.3	7.1	6.1	5.2	4.2	3.2	2.3
4009	7.2	7.2	6.9	5.8	4.8	3.8	8.9	7.9	6.8	5.8	4.8	3.7
4012	9.2	9.2	8.7	7.0	5.4	3.8	11.9	10.3	8.6	7.0	5.4	3.8
4018	14.8	14.8	14.0	11.4	8.9	6.3	17.5	16.5	14.0	11.4	8.9	6.3
4023	18.0	18.0	17.0	13.9	10.8	7.7	23.4	20.4	17.3	14.1	11.0	7.8
4031	24.0	24.0	22.6	18.4	14.1	9.9	31.0	26.8	22.6	18.3	14.1	9.9
4038	31.0	31.0	29.2	23.9	18.6	13.3	38.0	34.5	29.2	23.9	18.6	13.3
4044	39.0	39.0	36.8	30.1	23.4	16.7	44.0	41.6	35.5	29.5	23.4	17.3
4060	45.0	45.0	42.1	33.3	24.4	15.6	59.6	50.8	42.0	33.2	24.4	15.6
4075	60.0	60.0	56.6	46.3	36.0	25.7	74.9	70.2	59.3	48.4	37.5	26.5
4089	75.0	75.0	70.7	57.9	45.0	32.1	89.2	84.5	71.5	58.6	45.6	32.7
4103	91.0	91.0	85.8	70.2	54.6	39.0	103.0	100.5	85.2	69.9	54.6	39.3
4140	112.0	105.3	85.1	65.0	44.8	-	140.0	114.1	88.1	62.0	36.0	-
4168	150.0	141.0	114.0	87.0	60.0	-	168.0	141.8	115.6	89.5	63.3	-
4208	180.0	169.2	136.8	104.4	72.0	-	208.0	165.5	123.1	80.6	38.1	-
4250	216.0	203.0	164.2	125.3	86.4	-	250.0	207.7	165.3	123.0	80.6	-
4302	260.0	244.4	197.6	150.8	104.0	-	302.0	252.2	202.3	152.5	102.6	-
4371	304.0	285.8	231.0	176.3	121.6	-	371.0	305.3	239.7	174.0	108.3	-
4414	371.0	348.7	282.0	215.2	148.4	-	414.0	348.6	282.8	216.9	151.1	-
4477	389.0	292.5	-	-	-	-	477.0	312.4	-	-	-	-
4568	477.0	358.7	-	-	-	-	568.0	372.0	-	-	-	-
4605	605.0	455.0	-	-	-	-	675.0	455.0	-	-	-	-
4720	605.0	455.0	-	-	-	-	720.0	485.3	-	-	-	-

*1 The upper values are for $A1-02 = 6$ [Control Method Selection = AOLV/PM]. The values in parenthesis are for $A1-02 = 4$ [ALOV].

Table 10.22 AOLV, AOLV/PM Carrier Frequency and Rated Current Derating

Model	Rated Current (A)											
	Heavy Duty Rating (HD) ^{*/} Parameter C6-01 = 0						Normal Duty Rating (ND) ^{*/} Parameter C6-01 = 1					
	2 kHz (2 kHz)	4 kHz (-)	6 kHz (5 kHz)	8 kHz (8 kHz)	10 kHz (10 kHz)	12 kHz (12.5 kHz)	2 kHz (2 kHz)	4 kHz (-)	6 kHz (5 kHz)	8 kHz (8 kHz)	10 kHz (10 kHz)	12 kHz (12.5 kHz)
4002	2.1	1.8	1.5	1.2	0.9	0.6	2.1	1.9	1.7	1.6	1.4	1.2
4004	3.0	3.0	2.8	2.1	1.5	0.9	3.4	3.0	2.7	2.3	2.0	1.6
4005	4.3	3.8	3.2	2.7	2.2	1.6	4.8	4.5	4.2	3.8	3.5	3.2
4007	6.2	5.4	4.5	3.7	2.8	2.0	6.9	6.0	5.0	4.1	3.2	2.2
4009	8.6	7.6	6.6	5.6	4.6	3.6	7.6	6.7	5.8	5.0	4.1	3.2
4012	9.8	8.5	7.2	5.8	4.5	3.1	11.0	9.5	8.0	6.5	5.0	3.5
4018	14.1	12.3	10.4	8.5	6.6	4.7	15.2	13.2	11.2	9.1	7.1	5.1

10.7 Drive Derating

Model	Rated Current (A)											
	Heavy Duty Rating (HD) ^{*/} Parameter C6-01 = 0						Normal Duty Rating (ND) ^{*/} Parameter C6-01 = 1					
	2 kHz (2 kHz)	4 kHz (-)	6 kHz (5 kHz)	8 kHz (8 kHz)	10 kHz (10 kHz)	12 kHz (12.5 kHz)	2 kHz (2 kHz)	4 kHz (-)	6 kHz (5 kHz)	8 kHz (8 kHz)	10 kHz (10 kHz)	12 kHz (12.5 kHz)
4023	18.0	15.6	13.2	10.8	8.4	6.0	21.0	18.3	15.5	12.7	9.9	7.0
4031	27.2	23.5	19.8	16.1	12.4	8.7	27.0	23.3	19.6	16.0	12.3	8.6
4038	34.7	30.1	25.5	20.8	16.2	11.6	34.0	30.9	26.2	21.4	16.6	11.9
4044	34.0	34.0	32.1	26.2	20.4	14.6	40.0	37.8	32.3	26.8	21.3	15.8
4060	40.0	40.0	37.4	29.6	21.7	13.9	52.0	44.3	36.7	29.0	21.3	13.6
4075	52.0	52.0	49.0	40.1	31.2	22.3	65.0	60.9	51.4	42.0	32.5	23.0
4089	65.0	65.0	61.3	50.1	39.0	27.9	77.0	72.9	61.7	50.6	39.4	28.2
4103	77.0	77.0	72.6	59.4	46.2	33.0	96.0	93.6	79.4	65.1	50.9	36.6
4140	96.0	90.2	73.0	55.7	38.4	-	124.0	101.1	78.0	54.9	31.9	-
4168	124.0	116.6	94.2	71.9	49.6	-	156.0	131.7	107.4	83.1	58.8	-
4208	156.0	146.6	118.6	90.5	62.4	-	180.0	143.2	106.5	69.7	33.0	-
4250	180.0	169.2	136.8	104.4	72.0	-	240.0	199.4	158.7	118.1	77.4	-
4302	240.0	225.6	182.4	139.2	96.0	-	302.0	252.2	202.3	152.5	102.6	-
4371	302.0	283.9	229.5	175.2	120.8	-	361.0	297.2	233.5	169.7	105.9	-
4414	361.0	339.3	274.4	209.4	144.4	-	414.0	347.6	281.1	214.7	148.3	-
4477	414.0	310.5	-	-	-	-	477.0	312.6	-	-	-	-
4568	477.0	357.8	-	-	-	-	515.0	337.5	-	-	-	-
4605	515.0	386.3	-	-	-	-	605.0	406.7	-	-	-	-
4720	605.0	453.8	-	-	-	-	720.0	484.0	-	-	-	-

*1 The upper values are for $A1-02 = 6$ [Control Method Selection = AOLV/PM]. The values in parenthesis are for $A1-02 = 4$ [ALOV].

◆ Derating Depending on Ambient Temperature

When you install drives in a place where ambient temperatures are higher than the rated conditions or install drives side-by-side in the enclosure panel, set L8-12 [Ambient Temperature] and L8-35 [Installation Method Selection]. Derate the output current as specified in Figure 10.1.

No. (Hex.)	Name	Description	Default (Range)
L8-12 (04B8)	Ambient Temperature Setting	<input type="checkbox"/> V/f <input type="checkbox"/> CL-V/f <input type="checkbox"/> OLV <input type="checkbox"/> CLV <input type="checkbox"/> AOLV <input type="checkbox"/> OLV/PM <input type="checkbox"/> AOLV/PM <input type="checkbox"/> CLV/PM <input type="checkbox"/> EZOLV Sets the ambient temperature of the drive installation area.	40 °C (-10 °C - +50 °C)

No. (Hex.)	Name	Description	Default (Range)
L8-35 (04EC)	Installation Method Selection	<input type="checkbox"/> V/f <input type="checkbox"/> CL-V/f <input type="checkbox"/> OLV <input type="checkbox"/> CLV <input type="checkbox"/> AOLV <input type="checkbox"/> OLV/PM <input type="checkbox"/> AOLV/PM <input type="checkbox"/> CLV/PM <input type="checkbox"/> EZOLV Sets the type of drive installation.	Determined by the drive (0 - 3)

0 : IP20/OpenChassis Enc/Ex Heatsink

You can use the drive within the rated output current range of -10 °C to 50 °C 100%. Use this setting to install an IP20/UL Open Type drive or when the heatsink (cooling fin) is outside the enclosure panel.

Make sure that there is 30 mm (1.18 in) minimum of space between drives or between the drive and side of the enclosure panel.

1 : Side-by-Side Mounting

Derates the drive rated output current from "-10 °C to 30 °C 100%" to "30 °C 100%" to "50 °C 70%". Use this setting to install more than one drive Side-by-Side.

Make sure that there is 2 mm (0.08 in) minimum of space between drives.

2 : IP20/NEMA Type 1/IP55

Derates the drive rated output current from "-10 °C to 40 °C 100%" to "40 °C 100%" to "50 °C 85%". Use this setting to install IP55/UL Type 12 Heatsink External Mounting drives.

3 : Finless

Derates the drive rated output current from "-10 °C to 40 °C 100%" to "40 °C 100%" to "50 °C 85%". Use this setting to install a finless drive.

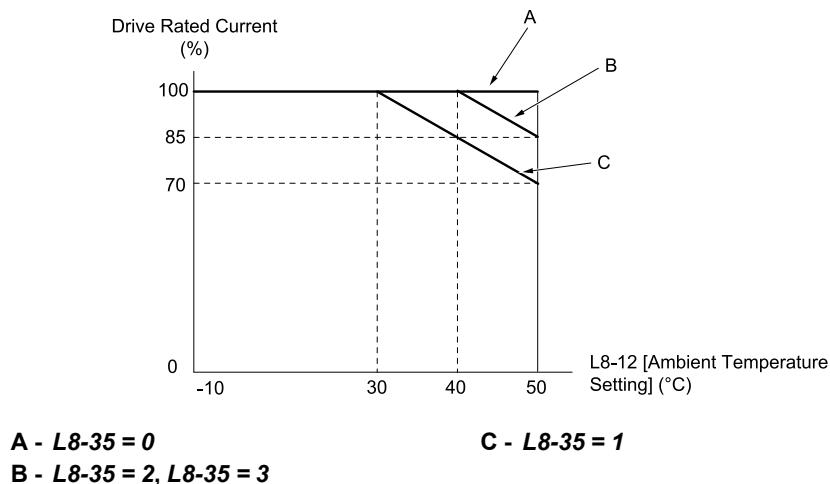

Figure 10.1 Derating Depending on Drive Installation Method

◆ Altitude Derating

Install the drive in a location that has an altitude of 1000 m (3281 ft) or lower.

Derate the output current by 1% for each 100 m (328 ft) to install the drive in altitudes between 1000 to 4000 m (3281 to 13123 ft).

It is not necessary to derate the rated voltage in these conditions:

- Installing the drive at 2000 m (6562 ft) or lower
- Installing the drive between 2000 to 4000 m (6562 to 13123 ft) and grounding the neutral point on the power supply.

If you do not ground the drive with a neutral network, contact Yaskawa or your nearest sales representative.

10.8 Drive Exterior and Mounting Dimensions

◆ Drive Models and Exterior/Mounting Dimensions

For exterior and mounting dimensions for IP55/UL Type 12 Heatsink External Mounting drives, refer to manual TOEPC7161779.

Table 10.23 Three-Phase 200 V

Model	Reference Page	
	IP20/UL Open Type	IP20/UL Type 1
2004 - 2042	453	463
2056	455	465
2070, 2082	456	466
2110	457	467
2138	458	468
2169, 2211	459	469
2257, 2313	460	470
2360	461	471
2415	461	-

Table 10.24 Three-Phase 400 V

Model	Reference Page	
	IP20/UL Open Type	IP20/UL Type 1
4002 - 4023	453	463
4031, 4038	455	465
4044 - 4060	456	466
4075	457	467
4089, 4103	458	468
4140, 4168	459	469
4208 - 4302	460	470
4371, 4414	461	471
4477 - 4720	462	472

◆ IP20/UL Open Type

■ 2004 to 2042, 4002 to 4023

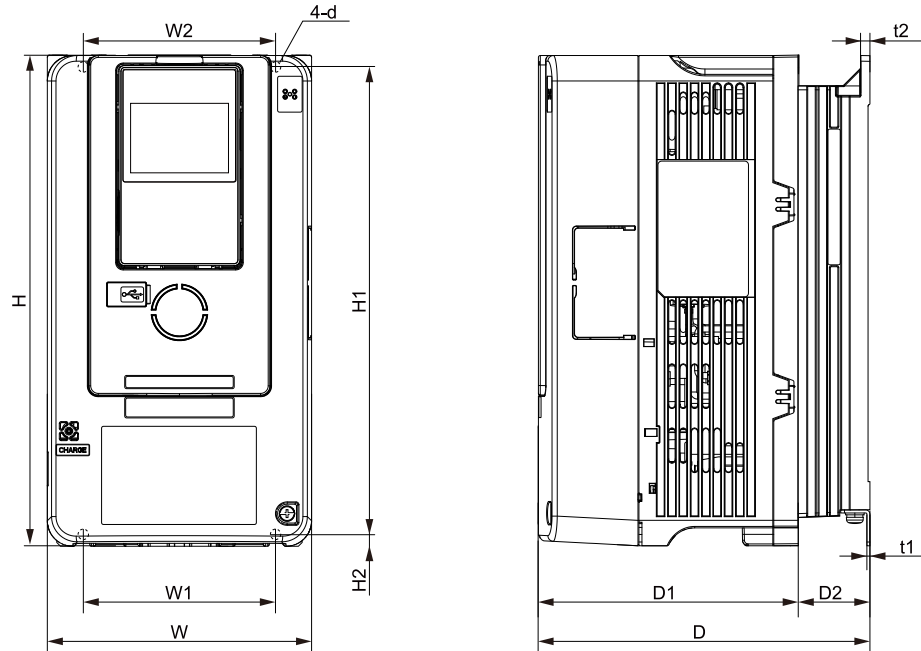

Figure 10.2 Exterior and Mounting Dimensions Diagram 1

Table 10.25 200 V Class (IP20)

Model	Dimensions mm (in)											Est. Weight kg (lb)	
	W	H	D	D1	D2	W1	W2	H1	H2	t1	t2		d
2004	140 (5.51)	260 (10.24)	176 (6.93)	138 (5.43)	38 (1.50)	102 (4.02)	102 (4.02)	248 (9.76)	6 (0.24)	1.6 (0.06)	5 (0.20)	M5	3.5 (7.72)
2006	140 (5.51)	260 (10.24)	176 (6.93)	138 (5.43)	38 (1.50)	102 (4.02)	102 (4.02)	248 (9.76)	6 (0.24)	1.6 (0.06)	5 (0.20)	M5	3.5 (7.72)
2008	140 (5.51)	260 (10.24)	176 (6.93)	138 (5.43)	38 (1.50)	102 (4.02)	102 (4.02)	248 (9.76)	6 (0.24)	1.6 (0.06)	5 (0.20)	M5	3.5 (7.72)
2010	140 (5.51)	260 (10.24)	176 (6.93)	138 (5.43)	38 (1.50)	102 (4.02)	102 (4.02)	248 (9.76)	6 (0.24)	1.6 (0.06)	5 (0.20)	M5	3.5 (7.72)
2012	140 (5.51)	260 (10.24)	176 (6.93)	138 (5.43)	38 (1.50)	102 (4.02)	102 (4.02)	248 (9.76)	6 (0.24)	1.6 (0.06)	5 (0.20)	M5	3.5 (7.72)
2018	140 (5.51)	260 (10.24)	211 (8.31)	138 (5.43)	73 (2.87)	102 (4.02)	102 (4.02)	248 (9.76)	6 (0.24)	1.6 (0.06)	5 (0.20)	M5	3.9 (8.60)
2021	140 (5.51)	260 (10.24)	211 (8.31)	138 (5.43)	73 (2.87)	102 (4.02)	102 (4.02)	248 (9.76)	6 (0.24)	1.6 (0.06)	5 (0.20)	M5	3.9 (8.60)
2030	140 (5.51)	260 (10.24)	211 (8.31)	138 (5.43)	73 (2.87)	102 (4.02)	102 (4.02)	248 (9.76)	6 (0.24)	1.6 (0.06)	5 (0.20)	M5	4.2 (9.26)
2042	140 (5.51)	260 (10.24)	211 (8.31)	138 (5.43)	73 (2.87)	102 (4.02)	102 (4.02)	248 (9.76)	6 (0.24)	1.6 (0.06)	5 (0.20)	M5	4.2 (9.26)

Table 10.26 400 V Class (IP20)

Model	Dimensions mm (in)											Est. Weight kg (lb)	
	W	H	D	D1	D2	W1	W2	H1	H2	t1	t2		d
4002	140 (5.51)	260 (10.24)	176 (6.93)	138 (5.43)	38 (1.50)	102 (4.02)	102 (4.02)	248 (9.76)	6 (0.24)	1.6 (0.06)	5 (0.20)	M5	3.5 (7.72)
4004	140 (5.51)	260 (10.24)	176 (6.93)	138 (5.43)	38 (1.50)	102 (4.02)	102 (4.02)	248 (9.76)	6 (0.24)	1.6 (0.06)	5 (0.20)	M5	3.5 (7.72)

Specifications

10.8 Drive Exterior and Mounting Dimensions

Model	Dimensions mm (in)											Est. Weight kg (lb)	
	W	H	D	D1	D2	W1	W2	H1	H2	t1	t2		d
4005	140 (5.51)	260 (10.24)	176 (6.93)	138 (5.43)	38 (1.50)	102 (4.02)	102 (4.02)	248 (9.76)	6 (0.24)	1.6 (0.06)	5 (0.20)	M5	3.5 (7.72)
4007	140 (5.51)	260 (10.24)	211 (8.31)	138 (5.43)	73 (2.87)	102 (4.02)	102 (4.02)	248 (9.76)	6 (0.24)	1.6 (0.06)	5 (0.20)	M5	3.9 (8.60)
4009	140 (5.51)	260 (10.24)	211 (8.31)	138 (5.43)	73 (2.87)	102 (4.02)	102 (4.02)	248 (9.76)	6 (0.24)	1.6 (0.06)	5 (0.20)	M5	3.9 (8.60)
4012	140 (5.51)	260 (10.24)	211 (8.31)	138 (5.43)	73 (2.87)	102 (4.02)	102 (4.02)	248 (9.76)	6 (0.24)	1.6 (0.06)	5 (0.20)	M5	3.9 (8.60)
4018	140 (5.51)	260 (10.24)	211 (8.31)	138 (5.43)	73 (2.87)	102 (4.02)	102 (4.02)	248 (9.76)	6 (0.24)	1.6 (0.06)	5 (0.20)	M5	4.2 (9.26)
4023	140 (5.51)	260 (10.24)	211 (8.31)	138 (5.43)	73 (2.87)	102 (4.02)	102 (4.02)	248 (9.76)	6 (0.24)	1.6 (0.06)	5 (0.20)	M5	4.2 (9.26)

■ 2056, 4031, 4038

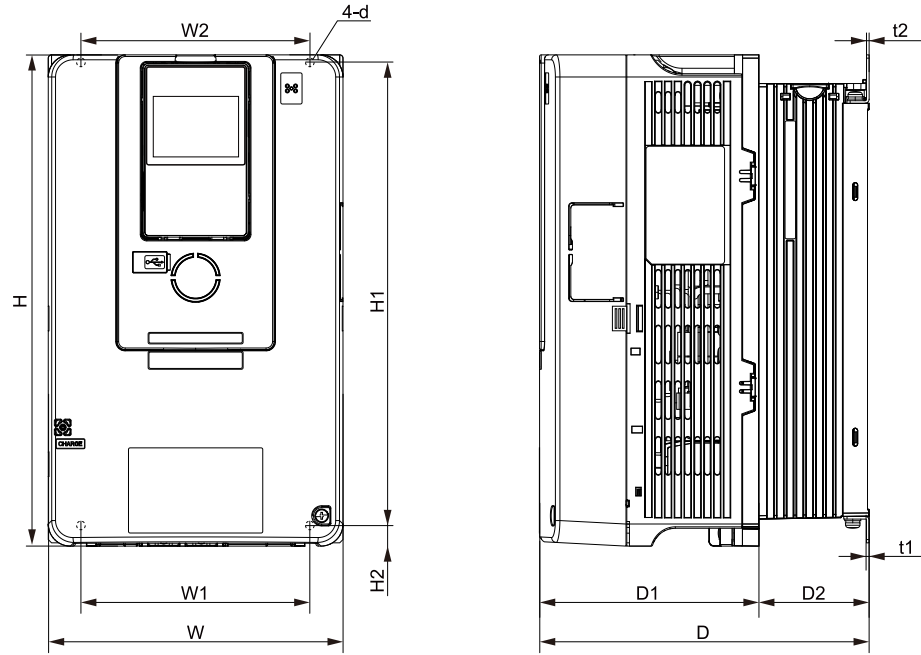

Figure 10.3 Exterior and Mounting Dimensions Diagram 2

Table 10.27 200 V Class (IP20)

Model	Dimensions mm (in)											Est. Weight kg (lb)	
	W	H	D	D1	D2	W1	W2	H1	H2	t1	t2		d
2056	180 (7.09)	300 (11.81)	202 (7.95)	134 (5.28)	68 (2.68)	140 (5.51)	140 (5.51)	284 (11.18)	8 (0.32)	1.6 (0.06)	1.6 (0.06)	M5	6 (13.23)

Table 10.28 400 V Class (IP20)

Model	Dimensions mm (in)											Est. Weight kg (lb)	
	W	H	D	D1	D2	W1	W2	H1	H2	t1	t2		d
4031	180 (7.09)	300 (11.81)	202 (7.95)	134 (5.28)	68 (2.68)	140 (5.51)	140 (5.51)	284 (11.18)	8 (0.32)	1.6 (0.06)	1.6 (0.06)	M5	6 (13.23)
4038	180 (7.09)	300 (11.81)	202 (7.95)	134 (5.28)	68 (2.68)	140 (5.51)	140 (5.51)	284 (11.18)	8 (0.32)	1.6 (0.06)	1.6 (0.06)	M5	6 (13.23)

■ 2070, 2082, 4044, 4060

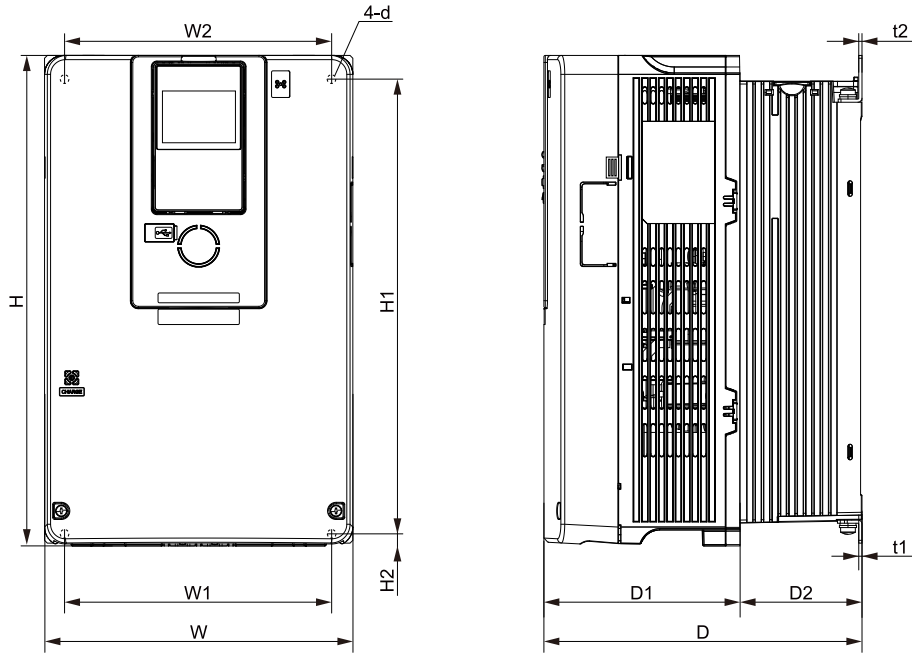

Figure 10.4 Exterior and Mounting Dimensions Diagram 3

Table 10.29 200 V Class (IP20)

Model	Dimensions mm (in)											Est. Weight kg (lb)	
	W	H	D	D1	D2	W1	W2	H1	H2	t1	t2		d
2070	220 (8.66)	350 (13.78)	227 (8.94)	140 (5.51)	87 (3.43)	192 (7.56)	192 (7.56)	335 (13.19)	8 (0.32)	2.3 (0.09)	2.3 (0.09)	M6	8.5 (18.74)
2082	220 (8.66)	350 (13.78)	227 (8.94)	140 (5.51)	87 (3.43)	192 (7.56)	192 (7.56)	335 (13.19)	8 (0.32)	2.3 (0.09)	2.3 (0.09)	M6	9.0 (19.84)

Table 10.30 400 V Class (IP20)

Model	Dimensions mm (in)											Est. Weight kg (lb)	
	W	H	D	D1	D2	W1	W2	H1	H2	t1	t2		d
4044	220 (8.66)	350 (13.78)	227 (8.94)	140 (5.51)	87 (3.43)	192 (7.56)	192 (7.56)	335 (13.19)	8 (0.32)	2.3 (0.09)	2.3 (0.09)	M6	7.5 (16.53)
4060	220 (8.66)	350 (13.78)	246 (9.69)	140 (5.51)	106 (4.17)	192 (7.56)	192 (7.56)	335 (13.19)	8 (0.32)	2.3 (0.09)	2.3 (0.09)	M6	12 (26.46)

■ 2110, 4075

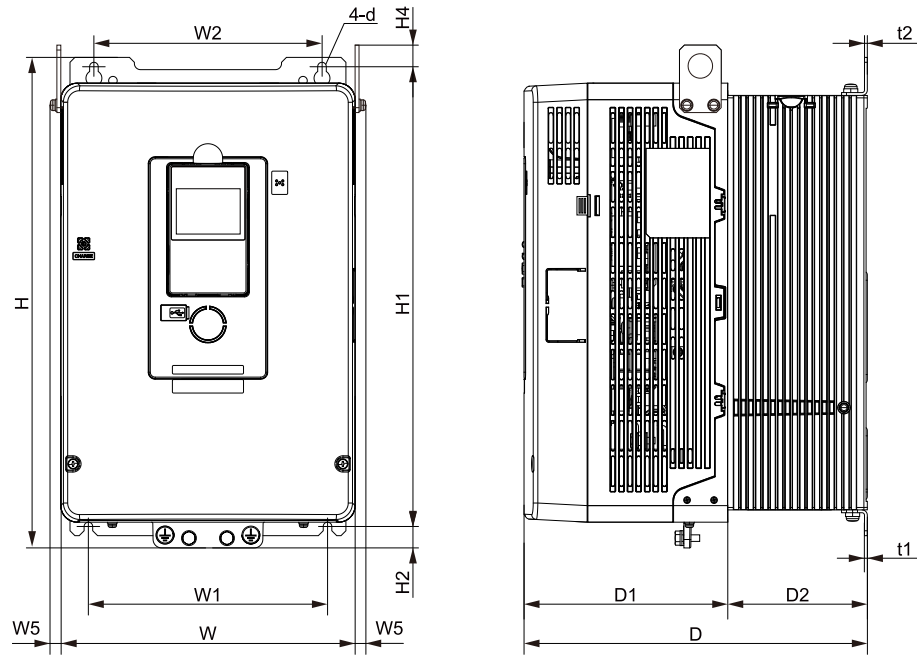

Figure 10.5 Exterior and Mounting Dimensions Diagram 4

Table 10.31 200 V Class (IP20)

Model	Dimensions mm (in)														Est. Weight kg (lb)
	W	H	D	D1	D2	W1	W2	W5 (maximum)	H1	H2	H4	t1	t2	d	
2110	240 (9.45)	400 (15.75)	280 (11.02)	166 (6.54)	114 (4.49)	195 (7.68)	186 (7.32)	12 (0.47)	375 (14.76)	17.5 (0.69)	17.5 (0.69)	2.3 (0.09)	2.3 (0.09)	M6	22 (48.50)

Table 10.32 400 V Class (IP20)

Model	Dimensions mm (in)														Est. Weight kg (lb)
	W	H	D	D1	D2	W1	W2	W5 (maximum)	H1	H2	H4	t1	t2	d	
4075	240 (9.45)	400 (15.75)	280 (11.02)	166 (6.54)	114 (4.49)	195 (7.68)	186 (7.32)	12 (0.47)	375 (14.76)	17.5 (0.69)	17.5 (0.69)	2.3 (0.09)	2.3 (0.09)	M6	17 (37.48)

■ 2138, 4089, 4103

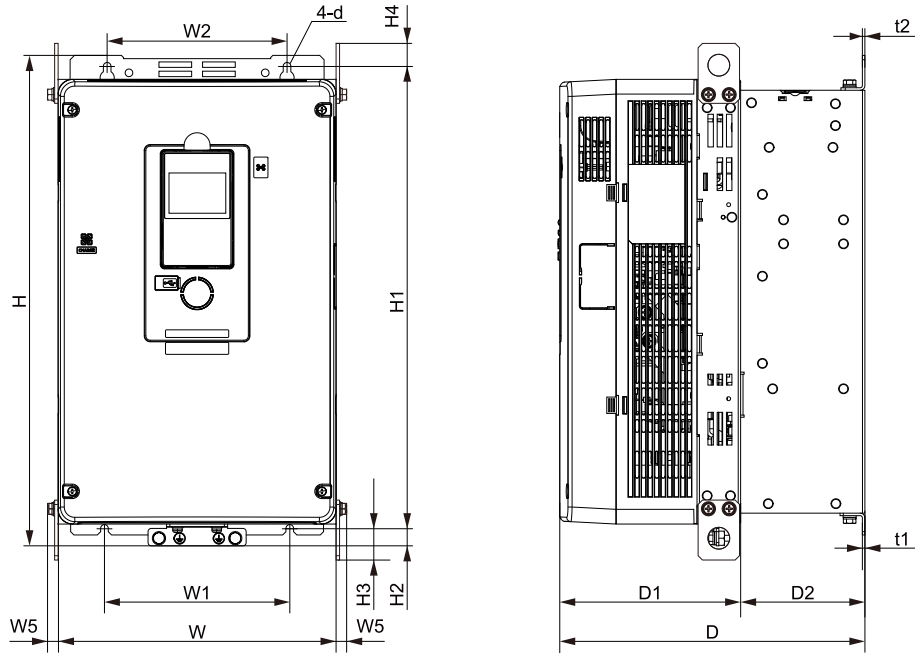

Figure 10.6 Exterior and Mounting Dimensions Diagram 5

Table 10.33 200 V Class (IP20)

Model	Dimensions mm (in)														Est. Weight kg (lb)	
	W	H	D	D1	D2	W1	W2	W5 (maximum)	H1	H2	H3	H4	t1	t2		d
2138	255 (10.04)	450 (17.72)	280 (11.02)	166 (6.54)	114 (4.49)	170 (6.69)	165 (6.50)	12 (0.47)	424 (16.69)	16 (0.63)	29 (1.14)	21 (0.83)	2.3 (0.09)	2.3 (0.09)	M6	24 (52.91)

Table 10.34 400 V Class (IP20)

Model	Dimensions mm (in)														Est. Weight kg (lb)	
	W	H	D	D1	D2	W1	W2	W5 (maximum)	H1	H2	H3	H4	t1	t2		d
4089	255 (10.04)	450 (17.72)	280 (11.02)	166 (6.54)	114 (4.49)	170 (6.69)	165 (6.50)	12 (0.47)	424 (16.69)	16 (0.63)	29 (1.14)	21 (0.83)	2.3 (0.09)	2.3 (0.09)	M6	22 (48.50)
4103	255 (10.04)	450 (17.72)	280 (11.02)	166 (6.54)	114 (4.49)	170 (6.69)	165 (6.50)	12 (0.47)	424 (16.69)	16 (0.63)	29 (1.14)	21 (0.83)	2.3 (0.09)	2.3 (0.09)	M6	25 (55.11)

■ 2169, 2211, 4140, 4168

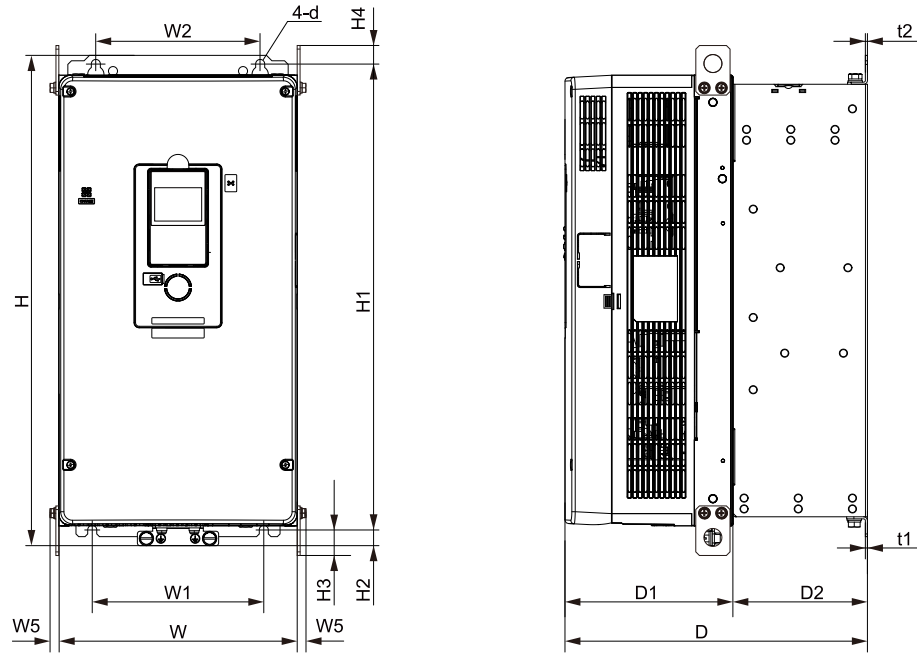

Figure 10.7 Exterior and Mounting Dimensions Diagram 6

Table 10.35 200 V Class (IP20)

Model	Dimensions mm (in)															Est. Weight kg (lb)
	W	H	D	D1	D2	W1	W2	W5 (maximum)	H1	H2	H3	H4	t1	t2	d	
2169	264 (10.39)	543 (21.38)	335 (13.19)	186 (7.32)	149 (5.87)	190 (7.48)	182 (7.17)	12 (0.47)	516 (20.31)	17.5 (0.69)	28.5 (1.12)	20.5 (0.81)	2.3 (0.09)	2.3 (0.09)	M8	39 (85.98)
2211	264 (10.39)	543 (21.38)	335 (13.19)	186 (7.32)	149 (5.87)	190 (7.48)	182 (7.17)	12 (0.47)	516 (20.31)	17.5 (0.69)	28.5 (1.12)	20.5 (0.81)	2.3 (0.09)	2.3 (0.09)	M8	40 (88.18)

Table 10.36 400 V Class (IP20)

Model	Dimensions mm (in)															Est. Weight kg (lb)
	W	H	D	D1	D2	W1	W2	W5 (maximum)	H1	H2	H3	H4	t1	t2	d	
4140	264 (10.39)	543 (21.38)	335 (13.19)	186 (7.32)	149 (5.87)	190 (7.48)	182 (7.17)	12 (0.47)	516 (20.31)	17.5 (0.69)	28.5 (1.12)	20.5 (0.81)	2.3 (0.09)	2.3 (0.09)	M8	38 (83.77)
4168	264 (10.39)	543 (21.38)	335 (13.19)	186 (7.32)	149 (5.87)	190 (7.48)	182 (7.17)	12 (0.47)	516 (20.31)	17.5 (0.69)	28.5 (1.12)	20.5 (0.81)	2.3 (0.09)	2.3 (0.09)	M8	39 (85.98)

■ 2257, 2313, 4208 to 4302

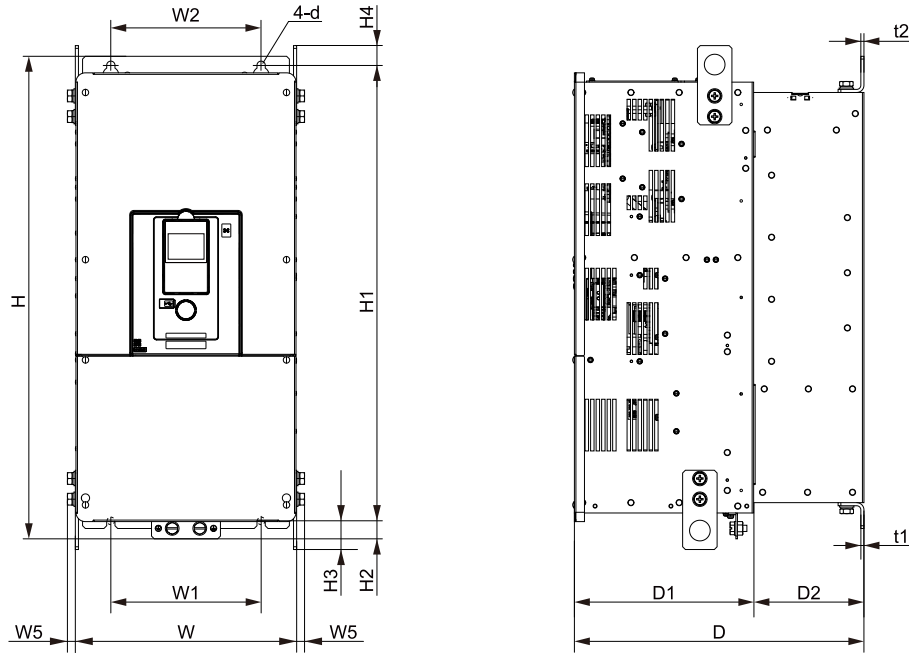

Figure 10.8 Exterior and Mounting Dimensions Diagram 7

Table 10.37 200 V Class (IP20)

Model	Dimensions mm (in)															Est. Weight kg (lb)
	W	H	D	D1	D2	W1	W2	W5 (maximum)	H1	H2	H3	H4	t1	t2	d	
2257	312 (12.28)	700 (27.56)	420 (16.54)	260 (10.24)	160 (6.30)	218 (8.58)	218 (8.58)	18 (0.71)	659 (25.94)	28 (1.10)	43.5 (1.71)	28.5 (1.12)	4.5 (0.18)	4.5 (0.18)	M10	67 (147.7)
2313	312 (12.28)	700 (27.56)	420 (16.54)	260 (10.24)	160 (6.30)	218 (8.58)	218 (8.58)	18 (0.71)	659 (25.94)	28 (1.10)	43.5 (1.71)	28.5 (1.12)	4.5 (0.18)	4.5 (0.18)	M10	67 (147.7)

Table 10.38 400 V Class (IP20)

Model	Dimensions mm (in)															Est. Weight kg (lb)
	W	H	D	D1	D2	W1	W2	W5 (maximum)	H1	H2	H3	H4	t1	t2	d	
4208	312 (12.28)	700 (27.56)	420 (16.54)	260 (10.24)	160 (6.30)	218 (8.58)	218 (8.58)	18 (0.71)	659 (25.94)	28 (1.10)	43.5 (1.71)	28.5 (1.12)	4.5 (0.18)	4.5 (0.18)	M10	71 (156.5)
4250	312 (12.28)	700 (27.56)	420 (16.54)	260 (10.24)	160 (6.30)	218 (8.58)	218 (8.58)	18 (0.71)	659 (25.94)	28 (1.10)	43.5 (1.71)	28.5 (1.12)	4.5 (0.18)	4.5 (0.18)	M10	71 (156.5)
4302	312 (12.28)	700 (27.56)	420 (16.54)	260 (10.24)	160 (6.30)	218 (8.58)	218 (8.58)	18 (0.71)	659 (25.94)	28 (1.10)	43.5 (1.71)	28.5 (1.12)	4.5 (0.18)	4.5 (0.18)	M10	71 (156.5)

■ 2360, 2415, 4371, 4414

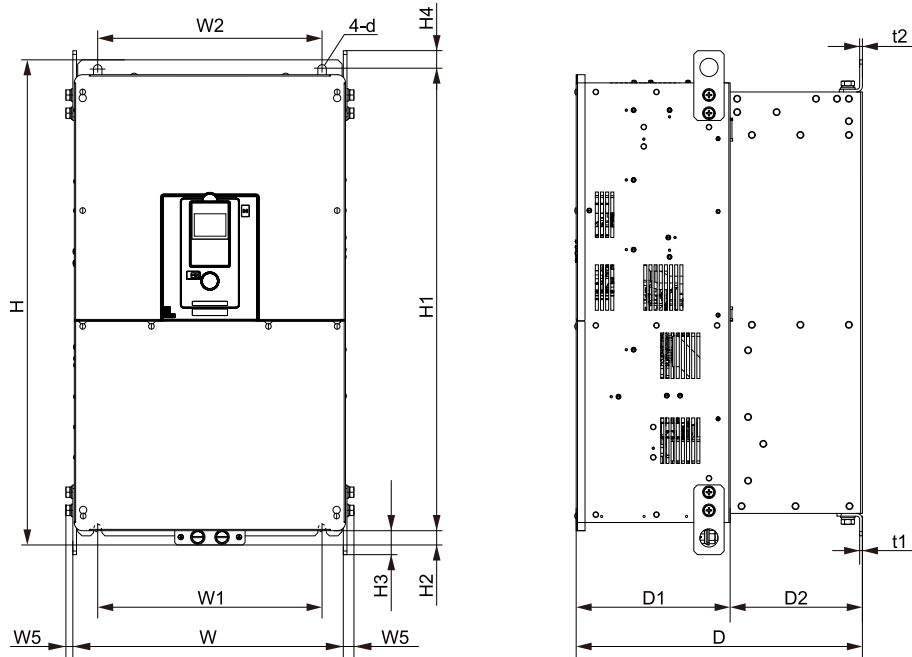

Figure 10.9 Exterior and Mounting Dimensions Diagram 8

Table 10.39 200 V Class (IP20)

Model	Dimensions mm (in)															Est. Weight kg (lb)
	W	H	D	D1	D2	W1	W2	W5 (maximum)	H1	H2	H3	H4	t1	t2	d	
2360	440 (17.32)	800 (31.50)	472 (18.58)	254 (10.00)	218 (8.58)	370 (14.57)	370 (14.57)	20 (0.79)	757 (29.80)	28 (1.10)	44 (1.73)	30 (1.18)	4.5 (0.18)	4.5 (0.18)	M12	104 (229.3)
2415	440 (17.32)	800 (31.50)	472 (18.58)	254 (10.00)	218 (8.58)	370 (14.57)	370 (14.57)	20 (0.79)	757 (29.80)	28 (1.10)	44 (1.73)	30 (1.18)	4.5 (0.18)	4.5 (0.18)	M12	119 (262.3)

Table 10.40 400 V Class (IP20)

Model	Dimensions mm (in)															Est. Weight kg (lb)
	W	H	D	D1	D2	W1	W2	W5 (maximum)	H1	H2	H3	H4	t1	t2	d	
4371	440 (17.32)	800 (31.50)	472 (18.58)	254 (10.00)	218 (8.58)	370 (14.57)	370 (14.57)	20 (0.79)	757 (29.80)	28 (1.10)	44 (1.73)	30 (1.18)	4.5 (0.18)	4.5 (0.18)	M12	122 (269.0)
4414	440 (17.32)	800 (31.50)	472 (18.58)	254 (10.00)	218 (8.58)	370 (14.57)	370 (14.57)	20 (0.79)	757 (29.80)	28 (1.10)	44 (1.73)	30 (1.18)	4.5 (0.18)	4.5 (0.18)	M12	126 (277.8)

■ 4477 - 4720

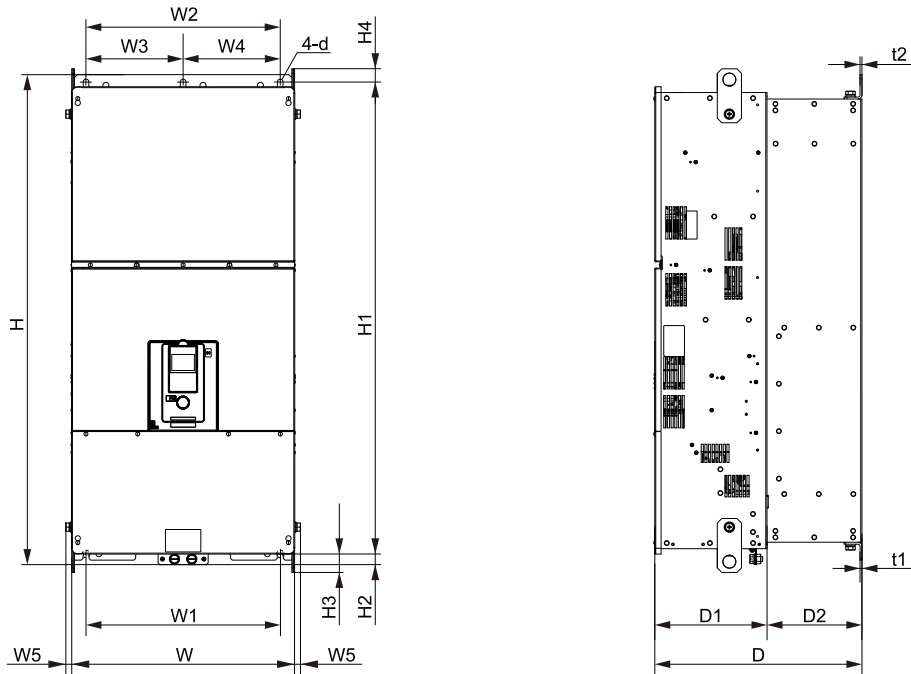

Figure 10.10 Exterior and Mounting Dimensions Diagram 9

Table 10.41 400 V Class (IP20)

Model	Dimensions mm (in)																	Est. Weight kg (lb)
	W	H	D	D1	D2	W1	W2	W3	W4	W5 (maximum)	H1	H2	H3	H4	t1	t2	d	
4477	510 (20.08)	1136 (44.72)	480 (18.90)	260 (10.24)	220 (8.66)	450 (17.72)	450 (17.72)	225 (8.86)	225 (8.86)	20 (0.79)	1093 (43.03)	25.5 (1.00)	43.5 (1.71)	30.5 (1.20)	4.5 (0.18)	4.5 (0.18)	M12	198 (436.5)
4568	510 (20.08)	1136 (44.72)	480 (18.90)	260 (10.24)	220 (8.66)	450 (17.72)	450 (17.72)	225 (8.86)	225 (8.86)	20 (0.79)	1093 (43.03)	25.5 (1.00)	43.5 (1.71)	30.5 (1.20)	4.5 (0.18)	4.5 (0.18)	M12	198 (436.5)
4605	510 (20.08)	1136 (44.72)	480 (18.90)	260 (10.24)	220 (8.66)	450 (17.72)	450 (17.72)	225 (8.86)	225 (8.86)	20 (0.79)	1093 (43.03)	25.5 (1.00)	43.5 (1.71)	30.5 (1.20)	4.5 (0.18)	4.5 (0.18)	M12	207 (456.3)
4720	510 (20.08)	1136 (44.72)	480 (18.90)	260 (10.24)	220 (8.66)	450 (17.72)	450 (17.72)	225 (8.86)	225 (8.86)	20 (0.79)	1093 (43.03)	25.5 (1.00)	43.5 (1.71)	30.5 (1.20)	4.5 (0.18)	4.5 (0.18)	M12	205 (451.9)

◆ IP20/UL Type 1

■ 2004 to 2042, 4002 to 4023

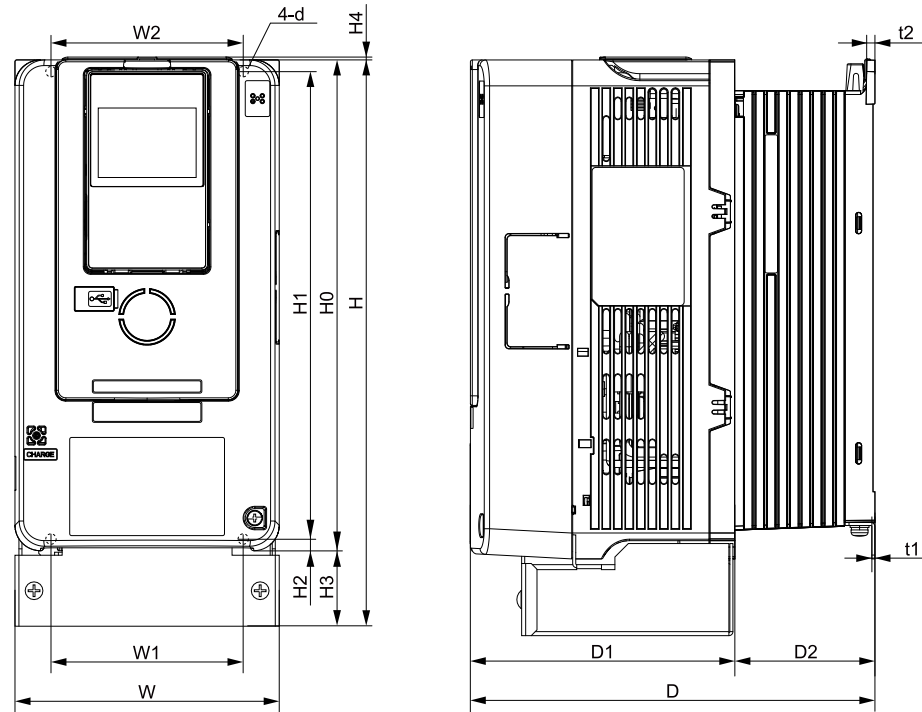

Figure 10.11 Exterior and Mounting Dimensions Diagram 1

Table 10.42 200 V Class (UL Type 1)

Model	Dimensions mm (in.)														Est. Weight kg (lb)	
	W	H	D	D1	D2	W1	W2	H0	H1	H2	H3	H4	t1	t2		d
2004	140 (5.51)	300 (11.81)	176 (6.93)	138 (5.43)	38 (1.50)	102 (4.02)	102 (4.02)	260 (10.24)	248 (9.76)	6 (0.24)	40 (1.57)	1.5 (0.06)	1.6 (0.06)	5 (0.20)	M5	4.1 (9.04)
2006	140 (5.51)	300 (11.81)	176 (6.93)	138 (5.43)	38 (1.50)	102 (4.02)	102 (4.02)	260 (10.24)	248 (9.76)	6 (0.24)	40 (1.57)	1.5 (0.06)	1.6 (0.06)	5 (0.20)	M5	4.1 (9.04)
2008	140 (5.51)	300 (11.81)	176 (6.93)	138 (5.43)	38 (1.50)	102 (4.02)	102 (4.02)	260 (10.24)	248 (9.76)	6 (0.24)	40 (1.57)	1.5 (0.06)	1.6 (0.06)	5 (0.20)	M5	4.1 (9.04)
2010	140 (5.51)	300 (11.81)	176 (6.93)	138 (5.43)	38 (1.50)	102 (4.02)	102 (4.02)	260 (10.24)	248 (9.76)	6 (0.24)	40 (1.57)	1.5 (0.06)	1.6 (0.06)	5 (0.20)	M5	4.1 (9.04)
2012	140 (5.51)	300 (11.81)	176 (6.93)	138 (5.43)	38 (1.50)	102 (4.02)	102 (4.02)	260 (10.24)	248 (9.76)	6 (0.24)	40 (1.57)	1.5 (0.06)	1.6 (0.06)	5 (0.20)	M5	4.1 (9.04)
2018	140 (5.51)	300 (11.81)	211 (8.31)	138 (5.43)	73 (2.87)	102 (4.02)	102 (4.02)	260 (10.24)	248 (9.76)	6 (0.24)	40 (1.57)	1.5 (0.06)	1.6 (0.06)	5 (0.20)	M5	4.5 (9.92)
2021	140 (5.51)	300 (11.81)	211 (8.31)	138 (5.43)	73 (2.87)	102 (4.02)	102 (4.02)	260 (10.24)	248 (9.76)	6 (0.24)	40 (1.57)	1.5 (0.06)	1.6 (0.06)	5 (0.20)	M5	4.5 (9.92)
2030	140 (5.51)	300 (11.81)	211 (8.31)	138 (5.43)	73 (2.87)	102 (4.02)	102 (4.02)	260 (10.24)	248 (9.76)	6 (0.24)	40 (1.57)	1.5 (0.06)	1.6 (0.06)	5 (0.20)	M5	4.8 (10.58)
2042	140 (5.51)	300 (11.81)	211 (8.31)	138 (5.43)	73 (2.87)	102 (4.02)	102 (4.02)	260 (10.24)	248 (9.76)	6 (0.24)	40 (1.57)	1.5 (0.06)	1.6 (0.06)	5 (0.20)	M5	4.8 (10.58)

Specifications

10.8 Drive Exterior and Mounting Dimensions

Table 10.43 400 V Class (UL Type 1)

Model	Dimensions mm (in.)															Est. Weight kg (lb)
	W	H	D	D1	D2	W1	W2	H0	H1	H2	H3	H4	t1	t2	d	
4002	140 (5.51)	300 (11.81)	176 (6.93)	138 (5.43)	38 (1.50)	102 (4.02)	102 (4.02)	260 (10.24)	248 (9.76)	6 (0.24)	40 (1.57)	1.5 (0.06)	1.6 (0.06)	5 (0.20)	M5	4.1 (9.04)
4004	140 (5.51)	300 (11.81)	176 (6.93)	138 (5.43)	38 (1.50)	102 (4.02)	102 (4.02)	260 (10.24)	248 (9.76)	6 (0.24)	40 (1.57)	1.5 (0.06)	1.6 (0.06)	5 (0.20)	M5	4.1 (9.04)
4005	140 (5.51)	300 (11.81)	176 (6.93)	138 (5.43)	38 (1.50)	102 (4.02)	102 (4.02)	260 (10.24)	248 (9.76)	6 (0.24)	40 (1.57)	1.5 (0.06)	1.6 (0.06)	5 (0.20)	M5	4.1 (9.04)
4007	140 (5.51)	300 (11.81)	211 (8.31)	138 (5.43)	73 (2.87)	102 (4.02)	102 (4.02)	260 (10.24)	248 (9.76)	6 (0.24)	40 (1.57)	1.5 (0.06)	1.6 (0.06)	5 (0.20)	M5	4.5 (9.92)
4009	140 (5.51)	300 (11.81)	211 (8.31)	138 (5.43)	73 (2.87)	102 (4.02)	102 (4.02)	260 (10.24)	248 (9.76)	6 (0.24)	40 (1.57)	1.5 (0.06)	1.6 (0.06)	5 (0.20)	M5	4.5 (9.92)
4012	140 (5.51)	300 (11.81)	211 (8.31)	138 (5.43)	73 (2.87)	102 (4.02)	102 (4.02)	260 (10.24)	248 (9.76)	6 (0.24)	40 (1.57)	1.5 (0.06)	1.6 (0.06)	5 (0.20)	M5	4.5 (9.92)
4018	140 (5.51)	300 (11.81)	211 (8.31)	138 (5.43)	73 (2.87)	102 (4.02)	102 (4.02)	260 (10.24)	248 (9.76)	6 (0.24)	40 (1.57)	1.5 (0.06)	1.6 (0.06)	5 (0.20)	M5	4.8 (10.58)
4023	140 (5.51)	300 (11.81)	211 (8.31)	138 (5.43)	73 (2.87)	102 (4.02)	102 (4.02)	260 (10.24)	248 (9.76)	6 (0.24)	40 (1.57)	1.5 (0.06)	1.6 (0.06)	5 (0.20)	M5	4.8 (10.58)

■ 2056, 4031, 4038

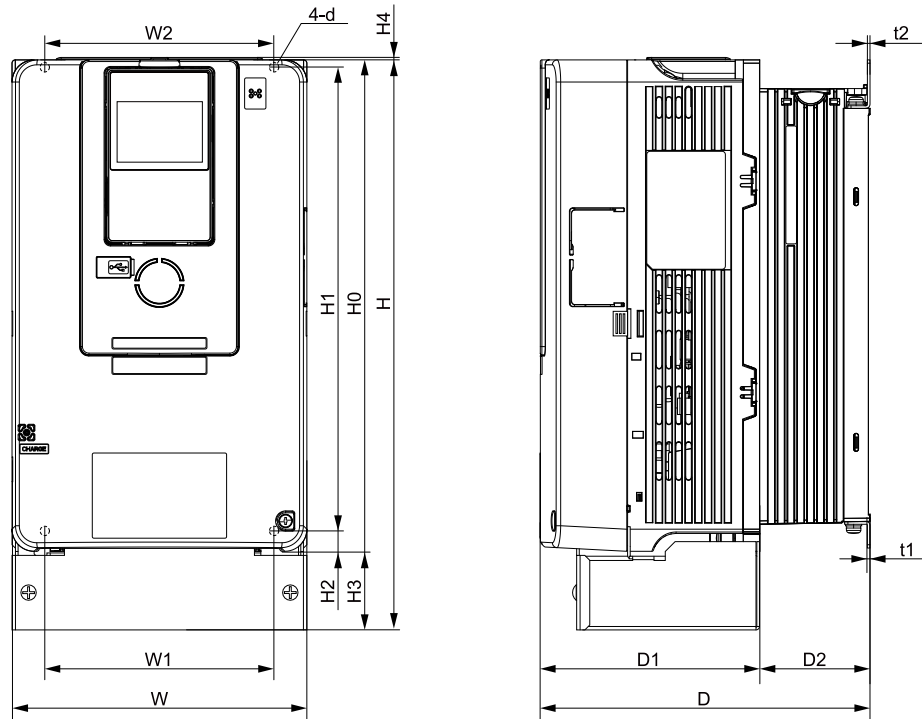

Figure 10.12 Exterior and Mounting Dimensions Diagram 2

Table 10.44 200 V Class (UL Type 1)

Model	Dimensions mm (in)															Est. Weight kg (lb)
	W	H	D	D1	D2	W1	W2	H0	H1	H2	H3	H4	t1	t2	d	
2056	180 (7.09)	340 (13.39)	202 (7.95)	134 (5.28)	68 (2.68)	140 (5.51)	140 (5.51)	300 (11.81)	284 (11.18)	8 (0.32)	40 (1.57)	1.5 (0.06)	1.6 (0.06)	1.6 (0.06)	M5	7 (15.43)

Table 10.45 400 V Class (UL Type 1)

Model	Dimensions mm (in)															Est. Weight kg (lb)
	W	H	D	D1	D2	W1	W2	H0	H1	H2	H3	H4	t1	t2	d	
4031	180 (7.09)	340 (13.39)	202 (7.95)	134 (5.28)	68 (2.68)	140 (5.51)	140 (5.51)	300 (11.81)	284 (11.18)	8 (0.32)	40 (1.57)	1.5 (0.06)	1.6 (0.06)	1.6 (0.06)	M5	7 (15.43)
4038	180 (7.09)	340 (13.39)	202 (7.95)	134 (5.28)	68 (2.68)	140 (5.51)	140 (5.51)	300 (11.81)	284 (11.18)	8 (0.32)	40 (1.57)	1.5 (0.06)	1.6 (0.06)	1.6 (0.06)	M5	7 (15.43)

■ 2070, 2082, 4044, 4060

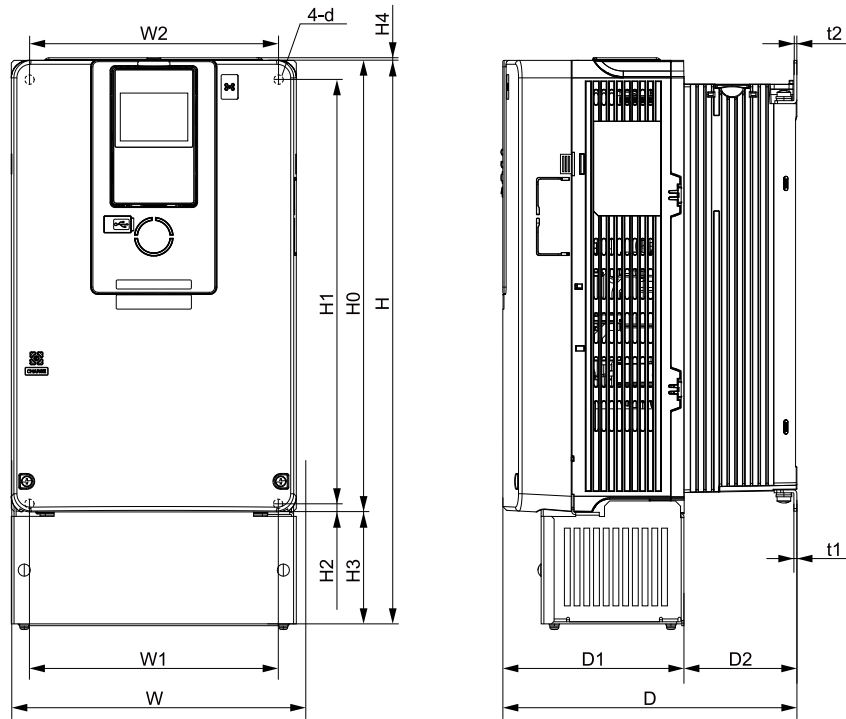

Figure 10.13 Exterior and Mounting Dimensions Diagram 3

Table 10.46 200 V Class (UL Type 1)

Model	Dimensions mm (in)														Est. Weight kg (lb)	
	W	H	D	D1	D2	W1	W2	H0	H1	H2	H3	H4	t1	t2		d
2070	220 (8.66)	400 (15.75)	227 (8.94)	140 (5.51)	87 (3.43)	192 (7.56)	192 (7.56)	350 (13.78)	335 (13.19)	8 (0.32)	50 (1.97)	1.5 (0.06)	2.3 (0.09)	2.3 (0.09)	M6	9 (19.84)
2082	220 (8.66)	435 (17.13)	227 (8.94)	140 (5.51)	87 (3.43)	192 (7.56)	192 (7.56)	350 (13.78)	335 (13.19)	8 (0.32)	85 (3.35)	1.5 (0.06)	2.3 (0.09)	2.3 (0.09)	M6	10 (22.05)

Table 10.47 400 V Class (UL Type 1)

Model	Dimensions mm (in)														Est. Weight kg (lb)	
	W	H	D	D1	D2	W1	W2	H0	H1	H2	H3	H4	t1	t2		d
4044	220 (8.66)	400 (15.75)	227 (8.94)	140 (5.51)	87 (3.43)	192 (7.56)	192 (7.56)	350 (13.78)	335 (13.19)	8 (0.32)	50 (1.97)	1.5 (0.06)	2.3 (0.09)	2.3 (0.09)	M6	8.5 (18.74)
4060	220 (8.66)	400 (15.75)	246 (9.69)	140 (5.51)	106 (4.17)	192 (7.56)	192 (7.56)	350 (13.78)	335 (13.19)	8 (0.32)	50 (1.97)	1.5 (0.06)	2.3 (0.09)	2.3 (0.09)	M6	13 (28.66)

■ 2110, 4075

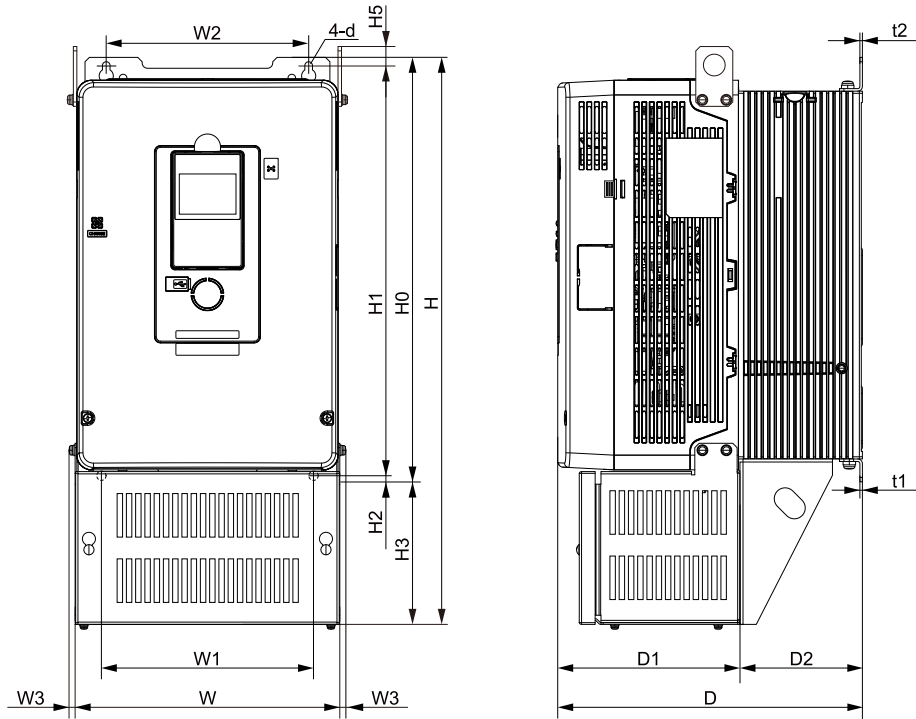

Figure 10.14 Exterior and Mounting Dimensions Diagram 4

Table 10.48 200 V Class (UL Type 1)

Model	Dimensions mm (in)															Est. Weight kg (lb)	
	W	H	D	D1	D2	W1	W2	W3 (maximum)	H0	H1	H2	H3	H5	t1	t2		d
2110	244 (9.61)	500 (19.69)	280 (11.02)	166 (6.54)	114 (4.49)	195 (7.68)	186 (7.32)	10 (0.39)	400 (15.75)	375 (14.76)	17.5 (0.69)	100 (3.94)	17.5 (0.69)	2.3 (0.09)	2.3 (0.09)	M6	24 (52.91)

Table 10.49 400 V Class (UL Type 1)

Model	Dimensions mm (in)															Est. Weight kg (lb)	
	W	H	D	D1	D2	W1	W2	W3 (maximum)	H0	H1	H2	H3	H5	t1	t2		d
4075	244 (9.61)	500 (19.69)	280 (11.02)	166 (6.54)	114 (4.49)	195 (7.68)	186 (7.32)	10 (0.39)	400 (15.75)	375 (14.76)	17.5 (0.69)	100 (3.94)	17.5 (0.69)	2.3 (0.09)	2.3 (0.09)	M6	20 (44.09)

■ 2138, 4089, 4103

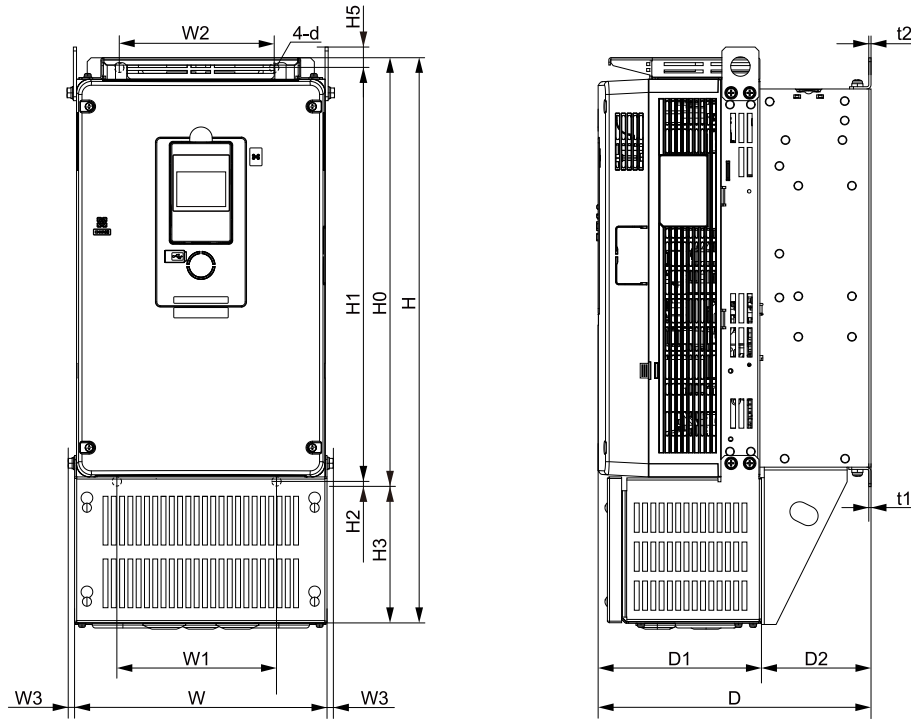

Figure 10.15 Exterior and Mounting Dimensions Diagram 5

Table 10.50 200 V Class (UL Type 1)

Model	Dimensions mm (in)															Est. Weight kg (lb)	
	W	H	D	D1	D2	W1	W2	W3 (maximum)	H0	H1	H2	H3	H5	t1	t2		d
2138	259 (10.20)	580 (22.83)	280 (11.02)	166 (6.54)	114 (4.49)	170 (6.69)	165 (6.50)	10 (0.39)	450 (17.72)	424 (16.69)	16 (0.63)	130 (5.12)	21 (0.83)	2.3 (0.09)	2.3 (0.09)	M6	27 (59.52)

Table 10.51 400 V Class (UL Type 1)

Model	Dimensions mm (in)															Est. Weight kg (lb)	
	W	H	D	D1	D2	W1	W2	W3 (maximum)	H0	H1	H2	H3	H5	t1	t2		d
4089	259 (10.20)	580 (22.83)	280 (11.02)	166 (6.54)	114 (4.49)	170 (6.69)	165 (6.50)	10 (0.39)	450 (17.72)	424 (16.69)	16 (0.63)	130 (5.12)	21 (0.83)	2.3 (0.09)	2.3 (0.09)	M6	25 (55.11)
4103	259 (10.20)	580 (22.83)	280 (11.02)	166 (6.54)	114 (4.49)	170 (6.69)	165 (6.50)	10 (0.39)	450 (17.72)	424 (16.69)	16 (0.63)	130 (5.12)	21 (0.83)	2.3 (0.09)	2.3 (0.09)	M6	29 (63.93)

■ 2169, 2211, 4140, 4168

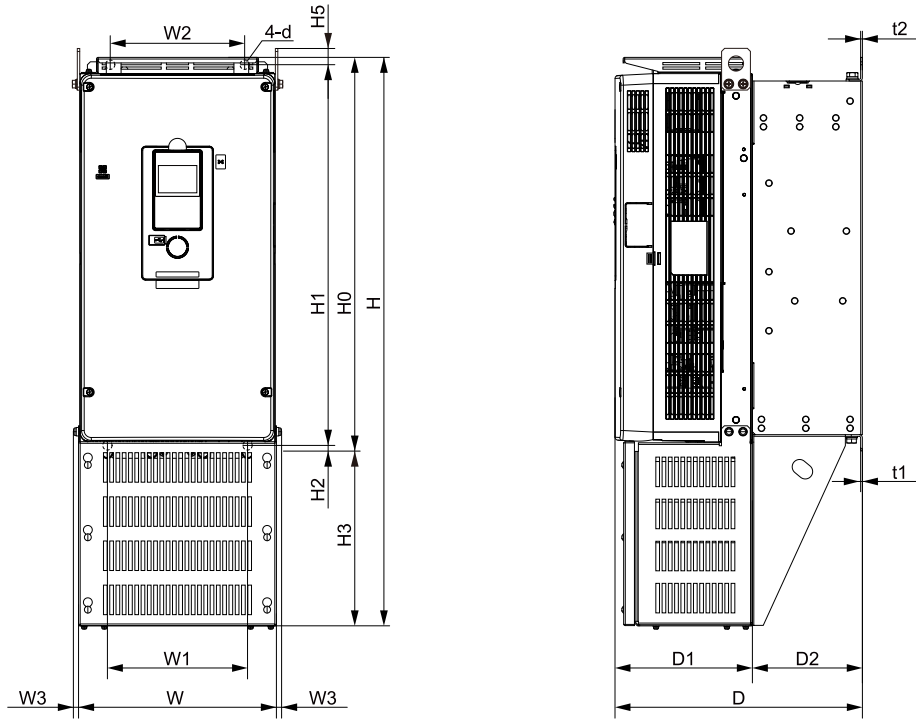

Figure 10.16 Exterior and Mounting Dimensions Diagram 6

Table 10.52 200 V Class (UL Type 1)

Model	Dimensions mm (in)															Est. Weight kg (lb)	
	W	H	D	D1	D2	W1	W2	W3 (maximum)	H0	H1	H2	H3	H5	t1	t2		d
2169	268 (10.55)	700 (27.56)	335 (13.19)	186 (7.32)	149 (5.87)	190 (7.48)	182 (7.17)	10 (0.39)	543 (21.38)	516 (20.31)	17.5 (0.69)	157 (6.18)	20.5 (0.81)	2.3 (0.09)	2.3 (0.09)	M8	44 (97.00)
2211	268 (10.55)	770 (30.31)	335 (13.19)	186 (7.32)	149 (5.87)	190 (7.48)	182 (7.17)	10 (0.39)	543 (21.38)	516 (20.31)	17.5 (0.69)	227 (8.94)	20.5 (0.81)	2.3 (0.09)	2.3 (0.09)	M8	46 (101.41)

Table 10.53 400 V Class (UL Type 1)

Model	Dimensions mm (in)															Est. Weight kg (lb)	
	W	H	D	D1	D2	W1	W2	W3 (maximum)	H0	H1	H2	H3	H5	t1	t2		d
4140	268 (10.55)	700 (27.56)	335 (13.19)	186 (7.32)	149 (5.87)	190 (7.48)	182 (7.17)	10 (0.39)	543 (21.38)	516 (20.31)	17.5 (0.69)	157 (6.18)	20.5 (0.81)	2.3 (0.09)	2.3 (0.09)	M8	43 (94.80)
4168	268 (10.55)	700 (27.56)	335 (13.19)	186 (7.32)	149 (5.87)	190 (7.48)	182 (7.17)	10 (0.39)	543 (21.38)	516 (20.31)	17.5 (0.69)	157 (6.18)	20.5 (0.81)	2.3 (0.09)	2.3 (0.09)	M8	44 (97.00)

■ 2257, 2313, 4208 to 4302

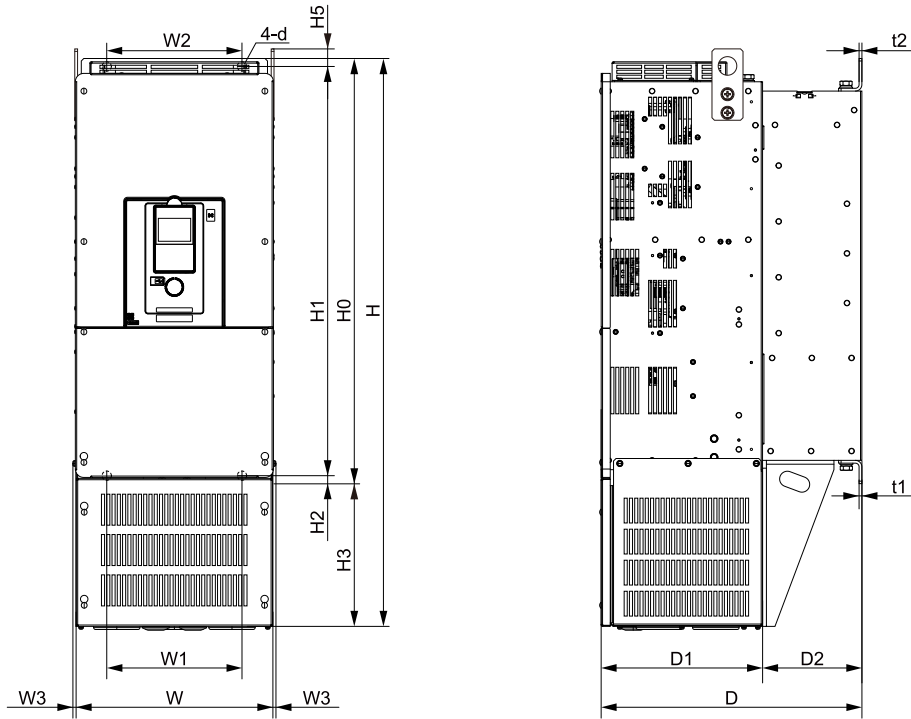

Figure 10.17 Exterior and Mounting Dimensions Diagram 7

Table 10.54 200 V Class (UL Type 1)

Model	Dimensions mm (in)															Est. Weight kg (lb)	
	W	H	D	D1	D2	W1	W2	W3 (maximum)	H0	H1	H2	H3	H5	t1	t2		d
2257	316 (12.44)	915 (36.02)	420 (16.54)	260 (10.24)	160 (6.30)	218 (8.58)	218 (8.58)	16 (0.63)	700 (27.56)	659 (25.94)	28 (1.10)	215 (8.46)	28.5 (1.12)	4.5 (0.18)	4.5 (0.18)	M10	72 (158.73)
2313	316 (12.44)	915 (36.02)	420 (16.54)	260 (10.24)	160 (6.30)	218 (8.58)	218 (8.58)	16 (0.63)	700 (27.56)	659 (25.94)	28 (1.10)	215 (8.46)	28.5 (1.12)	4.5 (0.18)	4.5 (0.18)	M10	72 (158.73)

Table 10.55 400 V Class (UL Type 1)

Model	Dimensions mm (in)															Est. Weight kg (lb)	
	W	H	D	D1	D2	W1	W2	W3 (maximum)	H0	H1	H2	H3	H5	t1	t2		d
4208	316 (12.44)	915 (36.02)	420 (16.54)	260 (10.24)	160 (6.30)	218 (8.58)	218 (8.58)	16 (0.63)	700 (27.56)	659 (25.94)	28 (1.10)	215 (8.46)	28.5 (1.12)	4.5 (0.18)	4.5 (0.18)	M10	79 (174.16)
4250	316 (12.44)	915 (36.02)	420 (16.54)	260 (10.24)	160 (6.30)	218 (8.58)	218 (8.58)	16 (0.63)	700 (27.56)	659 (25.94)	28 (1.10)	215 (8.46)	28.5 (1.12)	4.5 (0.18)	4.5 (0.18)	M10	79 (174.16)
4302	316 (12.44)	915 (36.02)	420 (16.54)	260 (10.24)	160 (6.30)	218 (8.58)	218 (8.58)	16 (0.63)	700 (27.56)	659 (25.94)	28 (1.10)	215 (8.46)	28.5 (1.12)	4.5 (0.18)	4.5 (0.18)	M10	79 (174.16)

■ 2360, 4371, 4414

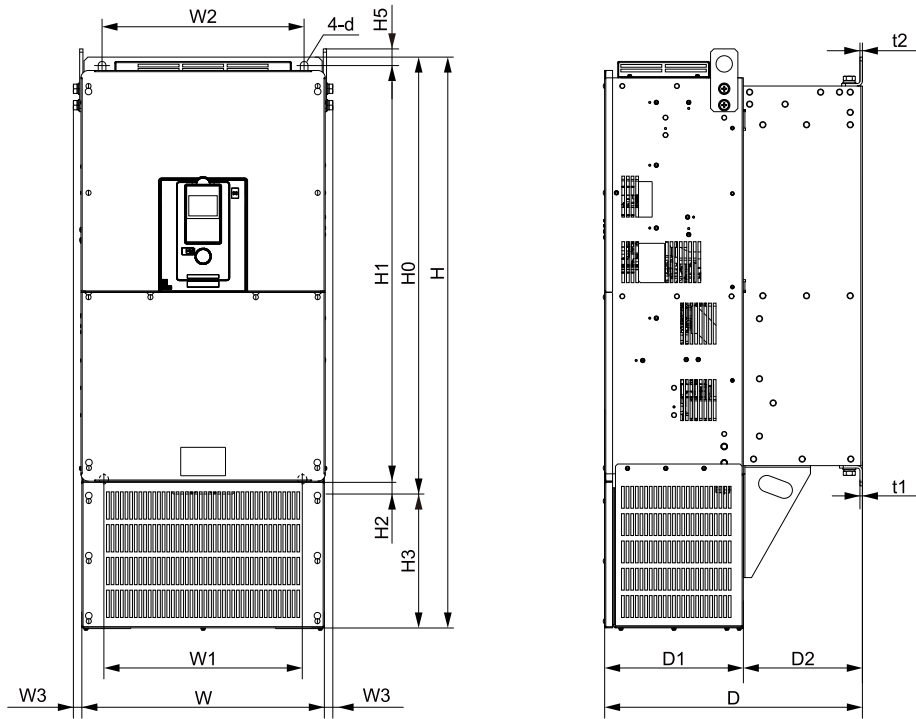

Figure 10.18 Exterior and Mounting Dimensions Diagram 8

Table 10.56 200 V Class (UL Type 1)

Model	Dimensions mm (in)															Est. Weight kg (lb)	
	W	H	D	D1	D2	W1	W2	W3 (maximum)	H0	H1	H2	H3	H5	t1	t2		d
2360	444 (17.48)	1045 (41.14)	472 (18.58)	254 (10.00)	218 (8.58)	370 (14.57)	370 (14.57)	18 (0.71)	800 (31.50)	757 (29.80)	28 (1.10)	245 (9.65)	30 (1.18)	4.5 (0.18)	4.5 (0.18)	M12	113 (249.12)

Table 10.57 400 V Class (UL Type 1)

Model	Dimensions mm (in)															Est. Weight kg (lb)	
	W	H	D	D1	D2	W1	W2	W3 (maximum)	H0	H1	H2	H3	H5	t1	t2		d
4371	444 (17.48)	1045 (41.14)	472 (18.58)	254 (10.00)	218 (8.58)	370 (14.57)	370 (14.57)	18 (0.71)	800 (31.50)	757 (29.80)	28 (1.10)	245 (9.65)	30 (1.18)	4.5 (0.18)	4.5 (0.18)	M12	130 (286.60)
4414	444 (17.48)	1045 (41.14)	472 (18.58)	254 (10.00)	218 (8.58)	370 (14.57)	370 (14.57)	18 (0.71)	800 (31.50)	757 (29.80)	28 (1.10)	245 (9.65)	30 (1.18)	4.5 (0.18)	4.5 (0.18)	M12	130 (286.60)

■ 4477 to 4720

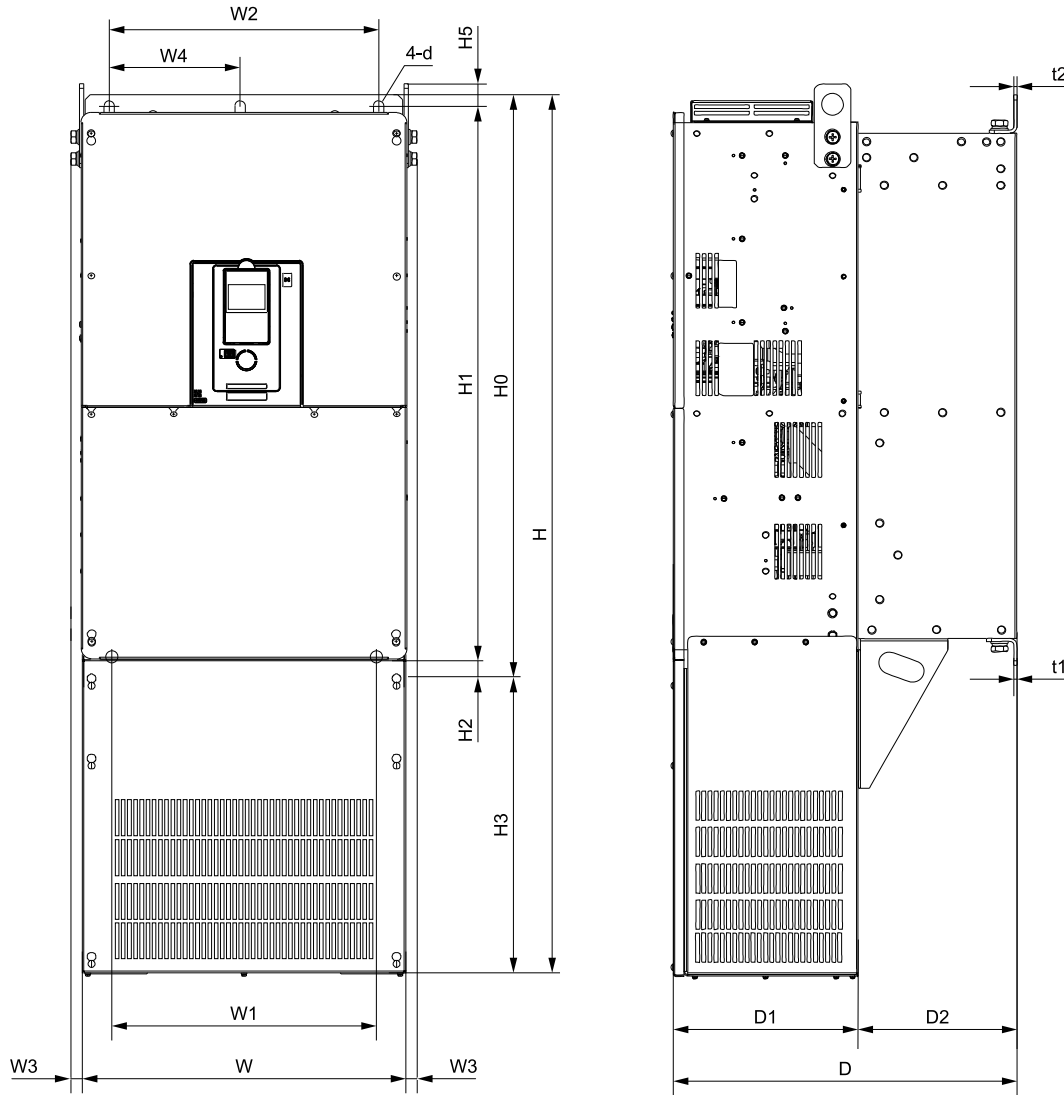

Figure 10.19 Exterior and Mounting Dimensions Diagram 9

Table 10.58 400 V Class (UL Type 1)

Model	Dimensions mm (in)																	Est. Weight kg (lb)
	W	H	D	D1	D2	W1	W2	W3 (maximum)	W4	H0	H1	H2	H3	H5	t1	t2	d	
4477	510 (20.08)	1789 (70.43)	480 (18.90)	260 (10.23)	220 (8.66)	450 (17.72)	450 (17.72)	20 (0.79)	225 (8.86)	1136 (44.70)	1093 (43.03)	43 (1.71)	664 (26.14)	35 (1.37)	4.5 (0.18)	4.5 (0.18)	M12	207 (455)
4568	510 (20.08)	1789 (70.43)	480 (18.90)	260 (10.23)	220 (8.66)	450 (17.72)	450 (17.72)	20 (0.79)	225 (8.86)	1136 (44.70)	1093 (43.03)	43 (1.71)	664 (26.14)	35 (1.37)	4.5 (0.18)	4.5 (0.18)	M12	207 (455)
4605	510 (20.08)	1789 (70.43)	480 (18.90)	260 (10.23)	220 (8.66)	450 (17.72)	450 (17.72)	20 (0.79)	225 (8.86)	1136 (44.70)	1093 (43.03)	43 (1.71)	664 (26.14)	35 (1.37)	4.5 (0.18)	4.5 (0.18)	M12	207 (455)
4720	510 (20.08)	1789 (70.43)	480 (18.90)	260 (10.23)	220 (8.66)	450 (17.72)	450 (17.72)	20 (0.79)	225 (8.86)	1136 (44.70)	1093 (43.03)	43 (1.71)	664 (26.14)	35 (1.37)	4.5 (0.18)	4.5 (0.18)	M12	207 (455)

10.9 Knock-Out Hole Dimensions (IP20/UL Type 1)

◆ Models and Dimensions of Knock-Out Hole

Model	Reference
2004 to 2042 4002 to 4023	473
2056 4031, 4038	474
2070, 2082 4044, 4060	474
2110 4075	475
2138 4089, 4103	475
2169 4140, 4168	476
2211	476
2257, 2313 4208 - 4302	477
2360	477

■ 2004 to 2042, 4002 to 4023

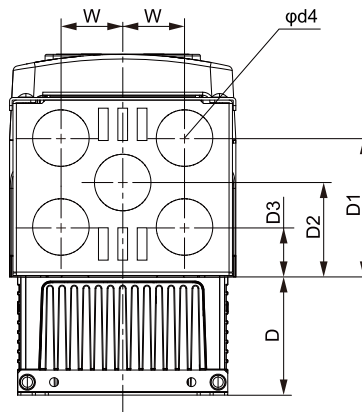

Figure 10.20 Knock-Out Dimensions Diagram 1 (Model: 2004 to 2042, 4002 to 4023)

Model	Dimensions mm (in)					
	D	D1	D2	D3	W	φd4
2004 to 2012 4002 to 4005	39 (1.54)	85 (3.35)	57.5 (2.26)	30 (1.18)	38.2 (1.50)	35 (1.38)
2018 to 2042 4007 to 4023	74 (2.91)	85 (3.35)	57.5 (2.26)	30 (1.18)	38.2 (1.50)	35 (1.38)

■ 2056, 4031, 4038

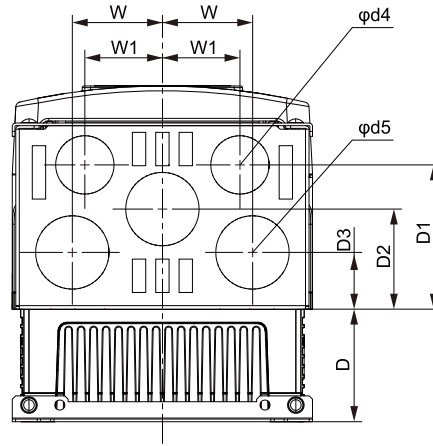

Figure 10.21 Knock-Out Dimensions Diagram 2 (Model: 2056, 4031, 4038)

Model	Dimensions mm (in)							
	D	D1	D2	D3	W	W1	φd4	φd5
2056	67.5	86.5	60	34	54	46.5	35	44
4031, 4038	(2.66)	(3.41)	(2.36)	(1.34)	(2.13)	(1.83)	(1.38)	(1.73)

■ 2070, 2082, 4044, 4060

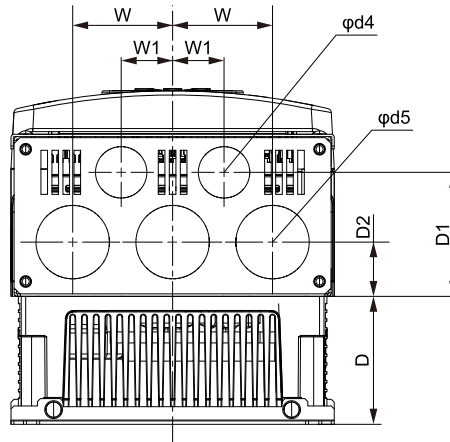

Figure 10.22 Knock-Out Dimensions Diagram 3 (Model: 2070, 2082, 4044, 4060)

Model	Dimensions mm (in)							
	D	D1	D2	W	W1	φd4	φd5	
2070, 2082	87.2	84.3	36.8	68	35	35	50	
4044	(3.43)	(3.32)	(1.45)	(2.68)	(1.38)	(1.38)	(1.97)	
4060	106.2	84.3	36.8	68	35	35	50	
	(4.18)	(3.32)	(1.45)	(2.68)	(1.38)	(1.38)	(1.97)	

■ 2110, 4075

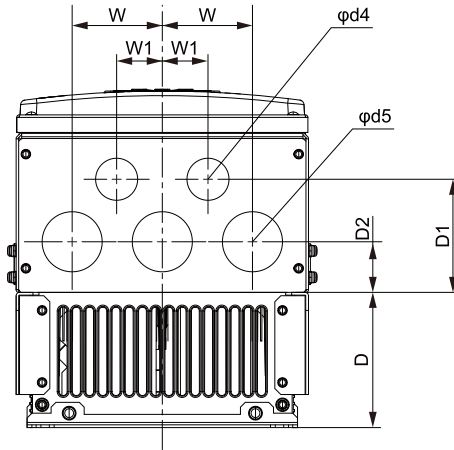

Figure 10.23 Knock-Out Dimensions Diagram 4 (Model: 2110, 4075)

Model	Dimensions mm (in)						
	D	D1	D2	W	W1	φd4	φd5
2110	112.5	96	48.5	73	38	35	50
4075	(4.43)	(3.78)	(1.91)	(2.87)	(1.50)	(1.38)	(1.97)

■ 2138, 4089, 4103

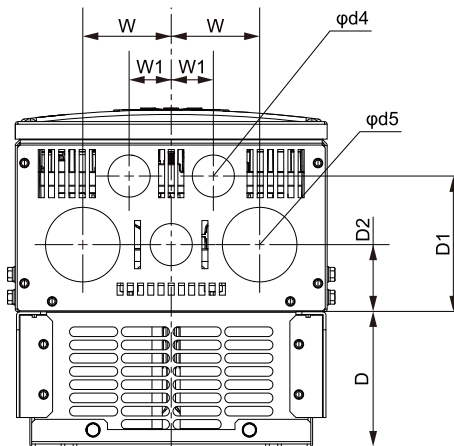

Figure 10.24 Knock-Out Dimensions Diagram 5 (Model: 2138, 4089, 4103)

Model	Dimensions mm (in)						
	D	D1	D2	W	W1	φd4	φd5
2138	112.4	112.8	55.8	73.5	35	35	62
4089, 4103	(4.43)	(4.44)	(2.20)	(2.89)	(1.38)	(1.38)	(2.44)

■ 2169, 4140, 4168

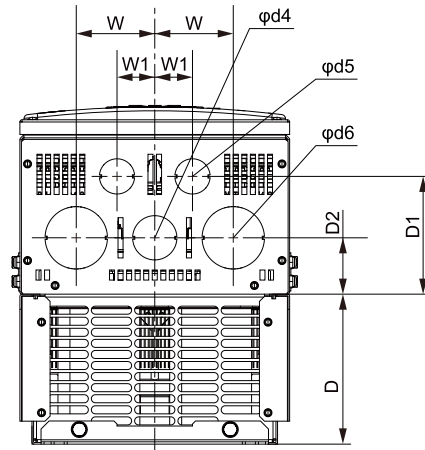

Figure 10.25 Knock-Out Dimensions Diagram 6 (Models: 2169, 4140, and 4168)

Model	Dimensions mm (in)							
	D	D1	D2	W	W1	φd4	φd5	φd6
2169	149	117	56	78	37.5	44	35	62
4140, 4168	(5.87)	(4.61)	(2.20)	(3.07)	(1.48)	(1.73)	(1.38)	(2.44)

■ 2211

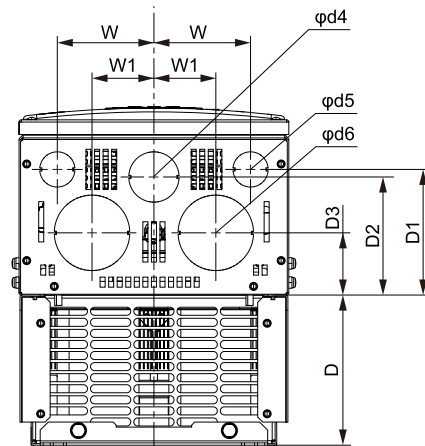

Figure 10.26 Knock-Out Dimensions Diagram 7 (Models: 2211)

Model	Dimensions mm (in)								
	D	D1	D2	D3	W	W1	φd4	φd5	φd6
2211	149	124.8	117.3	61.8	96	61.5	50	35	75
	(5.87)	(4.91)	(4.62)	(2.43)	(3.78)	(2.42)	(1.97)	(1.38)	(2.95)

■ 2257, 2313, 4208 to 4302

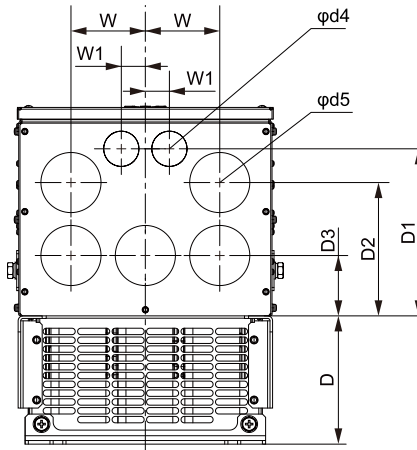

Figure 10.27 Knock-Out Dimensions Diagram 8 (Model:2257, 2313, 4208, 4250, 4302)

Model	Dimensions mm (in)							
	D	D1	D2	D3	W	W1	φd4	φd5
2257, 2313 4208, 4250, 4302	160 (6.30)	208.4 (8.20)	166.3 (6.55)	75.3 (2.96)	92.8 (3.65)	27.5 (1.08)	35 (1.38)	62 (2.44)

■ 2360

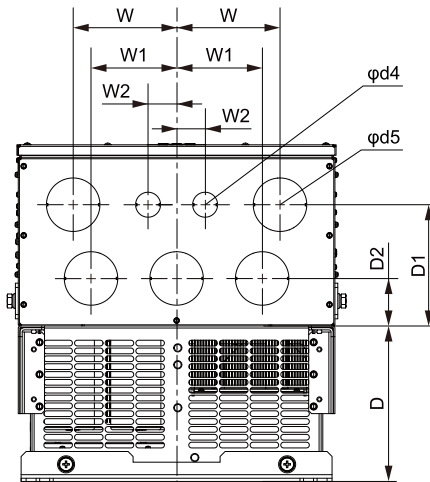

Figure 10.28 Knock-Out Dimensions Diagram 9 (Model: 2360)

Model	Dimensions mm (in)							
	D	D1	D2	W	W1	W2	φd4	φd5
2360	218 (8.58)	170 (6.69)	66.6 (2.62)	145 (5.71)	40 (1.57)	120 (4.72)	35 (1.38)	75 (2.95)

10.10 Peripheral Devices and Options

There are many available peripheral devices and options for the drive.

Refer to the the GA800 Selection Guide (SL.GA800.01) for information about available options, including:

- Main circuit options
- Frequency settings and monitor options
- Keypad options
- Attachment options
- Engineering tools

Contact Yaskawa or your nearest sales representative to make an order.

Refer to the instruction manual for each option for information about option installation and wiring.

Parameter List

11.1	Section Safety	480
11.2	How to Read the Parameter List	481
11.3	Parameter Groups	482
11.4	A: Initialization Parameters.....	484
11.5	b: Application	486
11.6	C: Tuning	497
11.7	d: Reference Settings.....	503
11.8	E: Motor Parameters.....	508
11.9	F: Options.....	513
11.10	H: Terminal Functions	526
11.11	L: Protection Functions	546
11.12	n: Special Adjustment.....	557
11.13	o: Keypad-Related Settings	565
11.14	q: DriveWorksEZ Parameters.....	571
11.15	r: DWEZ Connection 1-20	572
11.16	T: Motor Tuning	573
11.17	U: Monitors.....	577
11.18	Parameters that Change from the Default Settings with A1-02 [Control Method Selection]	590
11.19	Parameters that Change from the Default Settings with E3-01 [Motor 2 Control Mode Selection]	595
11.20	Parameters Changed by E1-03 [V/f Pattern Selection]	596
11.21	Defaults by Drive Model and Duty Rating ND/HD.....	598
11.22	Parameters Changed by PM Motor Code Selection	616

11.1 Section Safety









 **DANGER**

Do not ignore the safety messages in this manual.

If you ignore the safety messages in this manual, it will cause serious injury or death. The manufacturer is not responsible for injuries or damage to equipment.

11.2 How to Read the Parameter List

◆ Icons and Terms that Identify Parameters and Control Methods

Icon	Description
	The parameter is available when operating the drive with V/f Control.
	The parameter is available when operating the drive with Closed Loop V/f Control.
	The parameter is available when operating the drive with Open Loop Vector Control.
	The parameter is available when operating the drive with Closed Loop Vector Control.
	The parameter is available when operating the drive with Advanced Open Loop Vector Control.
	The parameter is available when operating the drive with Open Loop Vector Control for PM.
	The parameter is available when operating the drive with Advanced Open Loop Vector Control for PM.
	The parameter is available when operating the drive with Closed Loop Vector Control for PM.
	The parameter is available when operating the drive with EZ Open Loop Vector Control.
Hex.	Hexadecimal numbers that represent MEMOBUS addresses to change parameters over network communication.
RUN	You can change the parameter setting during Run.
Expert	The parameter that is available in Expert Mode only. ^{*1}

*1 Set $A1-01 = 3$ [Access Level Selection = Expert Level] to show and set Expert Mode parameters on the keypad.

Note:

Gray icons identify parameters that are not available in the specified control method.

11.3 Parameter Groups

Represents the type of product parameters.

Parameters	Name
A1	Initialization
A2	User Parameters
b1	Operation Mode Selection
b2	DC Injection Braking and Short Circuit Braking
b3	Speed Search
b4	Timer Function
b5	PID Control
b6	Dwell Function
b7	Droop Control
b8	Energy Saving
b9	Zero Servo
C1	Accel & Decel Time
C2	S-Curve Characteristics
C3	Slip Compensation
C4	Torque Compensation
C5	Auto Speed Regulator (ASR)
C6	Duty & Carrier Frequency
d1	Frequency Reference
d2	Reference Limits
d3	Jump Frequency
d4	Frequency Ref Up/Down & Hold
d5	Torque Control
d6	Field Weakening /Forcing
d7	Offset Frequency
E1	V/f Pattern for Motor 1
E2	Motor Parameters
E3	V/f Pattern for Motor 2
E4	Motor 2 Parameters
E5	PM Motor Settings
E9	Motor Setting
F1	PG Option Setup (Encoder)
F2	Analog Input Option
F3	Digital Input Option
F4	Analog Output Option
F5	Digital Output Option
F6	Communication Options
F7	Ethernet Options
H1	Digital Inputs
H2	Digital Outputs

Parameters	Name
H3	Analog Inputs
H4	Analog Outputs
H5	Modbus Communication
H6	Pulse Train Input/Output
H7	Virtual Inputs / Outputs
L1	Motor Protection
L2	Power Loss Ride Through
L3	Stall Prevention
L4	Speed Detection
L5	Fault Restart
L6	Torque Detection
L7	Torque Limit
L8	Drive Protection
L9	Drive Protection 2
n1	Hunting Prevention
n2	Auto Freq Regulator (AFR)
n3	High Slip/Overexcite Braking
n4	Adv Open Loop Vector Tune
n5	Feed Forward Control
n6	Online Tuning
n7	EZ Drive
n8	PM Motor Control Tuning
o1	Keypad Display
o2	Keypad Operation
o3	Copy Keypad Function
o4	Maintenance Monitors
o5	Log Function
q	DriveWorksEZ Parameters
r	DriveWorksEZ Connections
T0	Tuning Mode Selection
T1	InductionMotor Auto-Tuning
T2	PM Motor Auto-Tuning
T3	ASR and Inertia Tuning
T4	EZ Tuning
U1	Operation Status Monitors
U2	Fault Trace
U3	Fault History
U4	Maintenance Monitors
U5	PID Monitors

Parameters	Name
U6	Operation Status Monitors

Parameters	Name
U8	DriveWorksEZ Monitors

11.4 A: Initialization Parameters

◆ A1: Initialization

No. (Hex.)	Name	Description	Default (Range)	Ref.
A1-00 (0100) RUN	Language Selection	<p>V/f CL-V/f OLV CLV AOLV OLV/PM AOLV/PM CLV/PM EZOLV</p> <p>Sets the language for the LCD keypad.</p> <p>Note: When you use <i>A1-03 [Initialize Parameters]</i> to initialize the drive, the drive will not reset this parameter.</p> <p>0 : English 1 : Japanese 2 : German 3 : French 4 : Italian 5 : Spanish 6 : Portuguese 7 : Chinese 8 : Czech 9 : Russian 10 : Turkish 11 : Polish 12 : Greek</p>	0 (0 - 12)	639
A1-01 (0101) RUN	Access Level Selection	<p>V/f CL-V/f OLV CLV AOLV OLV/PM AOLV/PM CLV/PM EZOLV</p> <p>Sets user access to parameters. The access level controls which parameters the keypad will display, and which parameters the user can set.</p> <p>0 : Operation Only 1 : User Parameters 2 : Advanced Level 3 : Expert Level</p>	2 (0 - 3)	639
A1-02 (0102)	Control Method Selection	<p>V/f CL-V/f OLV CLV AOLV OLV/PM AOLV/PM CLV/PM EZOLV</p> <p>Sets the control method for the drive application and the motor.</p> <p>0 : V/f Control 1 : V/f Control with Encoder 2 : Open Loop Vector 3 : Closed Loop Vector 4 : Advanced Open Loop Vector 5 : PM Open Loop Vector 6 : PM Advanced Open Loop Vector 7 : PM Closed Loop Vector 8 : EZ Vector Control</p>	2 (0 - 8)	640
A1-03 (0103)	Initialize Parameters	<p>V/f CL-V/f OLV CLV AOLV OLV/PM AOLV/PM CLV/PM EZOLV</p> <p>Sets parameters to default values.</p> <p>0 : No Initialization 1110 : User Initialization 2220 : 2-Wire Initialization 3330 : 3-Wire Initialization</p>	0 (0 - 3330)	641
A1-04 (0104)	Password	<p>V/f CL-V/f OLV CLV AOLV OLV/PM AOLV/PM CLV/PM EZOLV</p> <p>Entry point for the password set in <i>A1-05 [Password Setting]</i>. The user can view the settings of parameters that are locked without entering the password. Enter the correct password in this parameter to change parameter settings.</p>	0000 (0000 - 9999)	642
A1-05 (0105)	Password Setting	<p>V/f CL-V/f OLV CLV AOLV OLV/PM AOLV/PM CLV/PM EZOLV</p> <p>Set the password to lock parameters and prevent changes to parameter settings. Enter the correct password in <i>A1-04 [Password]</i> to unlock parameters and accept changes.</p>	0000 (0000 - 9999)	643
A1-06 (0127)	Application Preset	<p>V/f CL-V/f OLV CLV AOLV OLV/PM AOLV/PM CLV/PM EZOLV</p> <p>Sets the drive to operate in selected application conditions.</p> <p>0 : General-purpose 1 : Water Supply Pump 2 2 : Conveyor 3 : Exhaust Fan 4 : HVAC Fan 5 : Air Compressor</p>	0 (0 - 5)	643

No. (Hex.)	Name	Description	Default (Range)	Ref.
A1-07 (0128)	DriveWorksEZ Function Selection	<p>V/f CL-V/f OLV CLV AOLV OLV/PM AOLV/PM CLV/PM EZOLV</p> <p>Sets the drive to operate with DriveWorksEZ. 0 : DWEZ Disabled 1 : DWEZ Enabled 2 : Enabled/Disabled wDigital Input</p>	0 (0 - 2)	656
A1-11 (111D) Expert	Firmware Update Lock	<p>V/f CL-V/f OLV CLV AOLV OLV/PM AOLV/PM CLV/PM EZOLV</p> <p>Protects the drive firmware. When you enable the protection, you cannot update the drive firmware. 0 : Disabled 1 : Enabled</p>	0 (0, 1)	656
A1-12 (1564)	Bluetooth ID	<p>V/f CL-V/f OLV CLV AOLV OLV/PM AOLV/PM CLV/PM EZOLV</p> <p>Sets the password necessary to use Bluetooth to control the drive with a smartphone or tablet.</p>	- (0000 - 9999)	657

◆ A2: User Parameters

No. (Hex.)	Name	Description	Default (Range)	Ref.
A2-01 to A2-32 (0106 - 0125)	User Parameters 1 to 32	<p>V/f CL-V/f OLV CLV AOLV OLV/PM AOLV/PM CLV/PM EZOLV</p> <p>You can select a maximum of 32 parameters for the drive and set them to parameters <i>A2-01 to A2-32</i>. The [User Parameters] section of the keypad main menu shows the set parameters. You can immediately access these set parameters.</p> <p>Note: Settings for <i>A2-01 to A2-32</i> change when the <i>A1-06 [Application Preset]</i> value changes.</p>	Parameters in General-Purpose Setup Mode (Determined by A1-06)	657
A2-33 (0126)	User Parameter Auto Selection	<p>V/f CL-V/f OLV CLV AOLV OLV/PM AOLV/PM CLV/PM EZOLV</p> <p>Sets the automatic save feature for changes to parameters <i>A2-17 to A2-32 [User Parameters 17 to 32]</i>. 0 : Disabled: Manual Entry Required 1 : Enabled: Auto Save Recent Parm</p>	Determined by A1-06 (0, 1)	657

11.5 b: Application

◆ b1: Operation Mode Selection

No. (Hex.)	Name	Description	Default (Setting Range)	Ref.
b1-01 (0180)	Frequency Reference Selection 1	<p>V/f CL-V/f OLV CLV AOLV OLV/PM AOLV/PM CLV/PM EZOLV</p> <p>Sets the input method for the frequency reference. 0 : Keypad 1 : Analog Input 2 : Memobus/Modbus Communications 3 : Option PCB 4 : Pulse Train Input</p>	1 (0 - 4)	658
b1-02 (0181)	Run Command Selection 1	<p>V/f CL-V/f OLV CLV AOLV OLV/PM AOLV/PM CLV/PM EZOLV</p> <p>Sets the input method for the Run command. 0 : Keypad 1 : Digital Input 2 : Memobus/Modbus Communications 3 : Option PCB</p>	1 (0 - 3)	660
b1-03 (0182)	Stopping Method Selection	<p>V/f CL-V/f OLV CLV AOLV OLV/PM AOLV/PM CLV/PM EZOLV</p> <p>Sets the method to stop the motor after removing a Run command or entering a Stop command. Note: When A1-02 = 3, 4, 5, 6, 7, 8 [Control Method Selection = CLV, AOLV, OLV/PM, AOLV/PM, CLV/PM, EZOLV], the setting range is 0, 1, 3. 0 : Ramp to Stop 1 : Coast to Stop 2 : DC Injection Braking to Stop 3 : Coast to Stop with Timer</p>	0 (0 - 3)	661
b1-04 (0183)	Reverse Operation Selection	<p>V/f CL-V/f OLV CLV AOLV OLV/PM AOLV/PM CLV/PM EZOLV</p> <p>Sets the reverse operation function. Disable reverse operation in fan or pump applications where reverse rotation is dangerous. 0 : Reverse Enabled 1 : Reverse Disabled</p>	0 (0, 1)	664
b1-05 (0184)	Operation Below Minimum Freq	<p>V/f CL-V/f OLV CLV AOLV OLV/PM AOLV/PM CLV/PM EZOLV</p> <p>Sets the drive operation when the frequency reference decreases to less than the value set in E1-09 [Minimum Output Frequency]. 0 : Operate at Frequency Reference 1 : Baseblock (Motor Coasts) 2 : Operate at Minimum Frequency 3 : Operate at Zero Speed</p>	0 (0 - 3)	664
b1-06 (0185)	Digital Input Reading	<p>V/f CL-V/f OLV CLV AOLV OLV/PM AOLV/PM CLV/PM EZOLV</p> <p>Sets the number of times that the drive reads the sequence input command to prevent malfunction because of noise. 0 : Single Scan 1 : Double Scan</p>	1 (0, 1)	665
b1-07 (0186)	LOCAL/REMOTE Run Selection	<p>V/f CL-V/f OLV CLV AOLV OLV/PM AOLV/PM CLV/PM EZOLV</p> <p>Sets drive response to an existing Run command when the drive receives a second Run command from a different location. 0 : Disregard Existing RUN Command 1 : Accept Existing RUN Command</p>	0 (0, 1)	666
b1-08 (0187)	Run Command Select in PRG Mode	<p>V/f CL-V/f OLV CLV AOLV OLV/PM AOLV/PM CLV/PM EZOLV</p> <p>Sets the conditions for the drive to accept a Run command entered from an external source when using the keypad to set parameters. 0 : Disregard RUN while Programming 1 : Accept RUN while Programming 2 : Allow Programming Only at Stop</p>	0 (0 - 2)	666
b1-09 (0188) Expert	LOCAL/REMOTE Select during RUN	<p>V/f CL-V/f OLV CLV AOLV OLV/PM AOLV/PM CLV/PM EZOLV</p> <p>Sets the function that lets you use the LO/RE during operation to switch between LOCAL and REMOTE Modes. 0 : Disabled 1 : Enabled</p>	0 (0, 1)	667

No. (Hex.)	Name	Description	Default (Setting Range)	Ref.
b1-14 (01C3)	Phase Order Selection	V/f CL-V/f OLV CLV AOLV OLV/PM AOLV/PM CLV/PM EZOLV Sets the phase order for output terminals U/T1, V/T2, and W/T3. This parameter can align the Forward Run command from the drive and the forward direction of the motor without changing wiring. 0 : Standard 1 : Switch Phase Order	0 (0, 1)	667
b1-15 (01C4)	Frequency Reference Selection 2	V/f CL-V/f OLV CLV AOLV OLV/PM AOLV/PM CLV/PM EZOLV Sets the input method for frequency reference 2. 0 : Keypad 1 : Analog Input 2 : Memobus/Modbus Communications 3 : Option PCB 4 : Pulse Train Input	0 (0 - 4)	667
b1-16 (01C5)	Run Command Selection 2	V/f CL-V/f OLV CLV AOLV OLV/PM AOLV/PM CLV/PM EZOLV Sets the input method for Run Command 2 when the user switches the control circuit terminals ON/OFF to change the Run command source. 0 : Keypad 1 : Digital Input 2 : Memobus/Modbus Communications 3 : Option PCB	0 (0 - 3)	669
b1-17 (01C6)	Run Command at Power Up	V/f CL-V/f OLV CLV AOLV OLV/PM AOLV/PM CLV/PM EZOLV Sets drive response when energizing a drive that has an external Run command. Set this parameter in applications where energizing or de-energizing the drive enables the Run command. 0 : Disregard Existing RUN Command 1 : Accept Existing RUN Command	0 (0, 1)	670
b1-21 (0748) Expert	CLV Start Selection	V/f CL-V/f OLV CLV AOLV OLV/PM AOLV/PM CLV/PM EZOLV Sets the conditions for the drive to accept a Run command when $A1-02 = 3, 7$ [Control Method Selection = CLV, CLV/PM]. Usually it is not necessary to change this setting. 0 : Reject RUN if $b2-01 < U1-05 < E1-09$ 1 : Accept RUN Command at Any Speed	0 (0, 1)	670
b1-35 (1117) Expert	Digital Input Deadband Time	V/f CL-V/f OLV CLV AOLV OLV/PM AOLV/PM CLV/PM EZOLV Sets the deadband time for MFDIs.	0.0 ms (0.0 to 100.0 ms)	671

◆ b2: DC Injection Braking and Short Circuit Braking

No. (Hex.)	Name	Description	Default (Range)	Ref.
b2-01 (0189)	DC Injection/Zero Speed Threshold	V/f CL-V/f OLV CLV AOLV OLV/PM AOLV/PM CLV/PM EZOLV Sets the frequency to start DC Injection Braking, Short Circuit Braking, and Zero Servo. Note: This parameter is available when $b1-03 = 0$ [Stopping Method Selection = Ramp to Stop].	Determined by A1-02 (0.0 - 10.0 Hz)	671
b2-02 (018A)	DC Injection Braking Current	V/f CL-V/f OLV CLV AOLV OLV/PM AOLV/PM CLV/PM EZOLV Sets the DC Injection Braking current as a percentage of the drive rated current.	50% (0 - 100%)	672
b2-03 (018B)	DC Inject Braking Time at Start	V/f CL-V/f OLV CLV AOLV OLV/PM AOLV/PM CLV/PM EZOLV Sets the DC Injection Braking Time at stop. Sets the time of Zero Speed Control at start when $A1-02 = 3, 7$ [Control Method Selection = CLV, CLV/PM].	A1-02 = 4: 0.03 s Other than A1-02 = 4: 0.00 s (0.00 - 10.00 s)	672
b2-04 (018C)	DC Inject Braking Time at Stop	V/f CL-V/f OLV CLV AOLV OLV/PM AOLV/PM CLV/PM EZOLV Sets the DC Injection Braking Time at stop. Sets the time of Zero Speed Control at stop when $A1-02 = 3, 7$ [Control Method Selection = CLV, CLV/PM].	Determined by A1-02 (0.00 - 10.00 s)	673
b2-08 (0190)	Magnetic Flux Compensation Value	V/f CL-V/f OLV CLV AOLV OLV/PM AOLV/PM CLV/PM EZOLV Sets how much current the drive injects when DC Injection Braking at Start starts (Initial Excitation) as a percentage of E2-03 [Motor No-Load Current].	0% (0 - 1000%)	673
b2-12 (01BA)	Short Circuit Brake Time @ Start	V/f CL-V/f OLV CLV AOLV OLV/PM AOLV/PM CLV/PM EZOLV Sets the Short Circuit Braking time at start.	0.00 s (0.00 - 25.50 s)	673

11.5 b: Application

No. (Hex.)	Name	Description	Default (Range)	Ref.
b2-13 (01BB)	Short Circuit Brake Time @ Stop	<p><input type="checkbox"/> V/f <input type="checkbox"/> CL-V/f <input type="checkbox"/> OLV <input type="checkbox"/> CLV <input type="checkbox"/> AOLV <input checked="" type="checkbox"/> OLV/PM <input type="checkbox"/> AOLV/PM <input type="checkbox"/> CLV/PM <input type="checkbox"/> EZOLV</p> <p>Sets the Short Circuit Braking time at stop.</p>	A1-02 = 8: 0.00 s Other than A1-02 = 8: 0.50 s (0.00 - 25.50 s)	674
b2-18 (0177)	Short Circuit Braking Current	<p><input type="checkbox"/> V/f <input type="checkbox"/> CL-V/f <input type="checkbox"/> OLV <input type="checkbox"/> CLV <input type="checkbox"/> AOLV <input checked="" type="checkbox"/> OLV/PM <input type="checkbox"/> AOLV/PM <input type="checkbox"/> CLV/PM <input type="checkbox"/> EZOLV</p> <p>Sets the Short Circuit Braking Current as a percentage of the motor rated current.</p> <p>Note: Parameter A1-02 [Control Method Selection] selects which parameter is the motor rated current. • A1-02 = 5, 6 [OLV/PM, AOLV/PM]: E5-03 [PM Motor Rated Current (FLA)] • A1-02 = 8 [EZOLV]: E9-06 [Motor Rated Current (FLA)]</p>	100.0% (0.0 - 200.0%)	674

◆ b3: Speed Search

No. (Hex.)	Name	Description	Default (Range)	Ref.
b3-01 (0191)	Speed Search at Start Selection	<p><input type="checkbox"/> V/f <input type="checkbox"/> CL-V/f <input type="checkbox"/> OLV <input type="checkbox"/> CLV <input type="checkbox"/> AOLV <input checked="" type="checkbox"/> OLV/PM <input type="checkbox"/> AOLV/PM <input type="checkbox"/> CLV/PM <input type="checkbox"/> EZOLV</p> <p>Sets the Speed Search at Start function where the drive will perform Speed Search with each Run command. 0 : Disabled 1 : Enabled</p>	Determined by A1-02 (0, 1)	678
b3-02 (0192)	SpeedSearch Deactivation Current	<p><input type="checkbox"/> V/f <input type="checkbox"/> CL-V/f <input checked="" type="checkbox"/> OLV <input type="checkbox"/> CLV <input type="checkbox"/> AOLV <input type="checkbox"/> OLV/PM <input type="checkbox"/> AOLV/PM <input type="checkbox"/> CLV/PM <input type="checkbox"/> EZOLV</p> <p>Sets the current level that stops Speed Search as a percentage of the drive rated output current. Usually it is not necessary to change this setting.</p>	Determined by A1-02 (0 - 200%)	678
b3-03 (0193)	Speed Search Deceleration Time	<p><input type="checkbox"/> V/f <input type="checkbox"/> CL-V/f <input type="checkbox"/> OLV <input type="checkbox"/> CLV <input type="checkbox"/> AOLV <input checked="" type="checkbox"/> OLV/PM <input type="checkbox"/> AOLV/PM <input type="checkbox"/> CLV/PM <input type="checkbox"/> EZOLV</p> <p>Sets the deceleration time during Speed Search operation. Set the length of time to decelerate from the maximum output frequency to the minimum output frequency.</p> <p>Note: When A1-02 = 8 [Control Method Selection = EZOLV], this parameter takes effect only in Expert Mode.</p>	2.0 s (0.1 - 10.0 s)	678
b3-04 (0194)	V/f Gain during Speed Search	<p><input type="checkbox"/> V/f <input type="checkbox"/> CL-V/f <input type="checkbox"/> OLV <input type="checkbox"/> CLV <input type="checkbox"/> AOLV <input type="checkbox"/> OLV/PM <input type="checkbox"/> AOLV/PM <input type="checkbox"/> CLV/PM <input type="checkbox"/> EZOLV</p> <p>Sets the ratio used to reduce the V/f during searches to reduce the output current during speed searches.</p>	Determined by o2-04 (10 - 100)	679
b3-05 (0195)	Speed Search Delay Time	<p><input type="checkbox"/> V/f <input type="checkbox"/> CL-V/f <input type="checkbox"/> OLV <input type="checkbox"/> CLV <input type="checkbox"/> AOLV <input checked="" type="checkbox"/> OLV/PM <input type="checkbox"/> AOLV/PM <input type="checkbox"/> CLV/PM <input type="checkbox"/> EZOLV</p> <p>Sets the Speed Search delay time to activate a magnetic contactor installed between the drive and motor.</p>	0.2 s (0.0 - 100.0 s)	679
b3-06 (0196) Expert	Speed Estimation Current Level 1	<p><input type="checkbox"/> V/f <input type="checkbox"/> CL-V/f <input type="checkbox"/> OLV <input type="checkbox"/> CLV <input type="checkbox"/> AOLV <input type="checkbox"/> OLV/PM <input type="checkbox"/> AOLV/PM <input type="checkbox"/> CLV/PM <input type="checkbox"/> EZOLV</p> <p>Sets the level of current that flows to the motor during Speed Estimation Speed Search as a coefficient of the motor rated current. Usually it is not necessary to change this setting.</p>	Determined by o2-04 (0.0 - 2.0)	679
b3-07 (0197) Expert	Speed Estimation Current Level 2	<p><input type="checkbox"/> V/f <input type="checkbox"/> CL-V/f <input type="checkbox"/> OLV <input type="checkbox"/> CLV <input type="checkbox"/> AOLV <input type="checkbox"/> OLV/PM <input type="checkbox"/> AOLV/PM <input type="checkbox"/> CLV/PM <input type="checkbox"/> EZOLV</p> <p>Sets the level of current that flows to the motor during Speed Estimation Speed Search as a coefficient of E2-03 [Motor No-Load Current] or E4-03 [Motor 2 Rated No-Load Current]. Usually it is not necessary to change this setting.</p>	1.0 (0.0 - 3.0)	679
b3-08 (0198)	Speed Estimation ACR P Gain	<p><input type="checkbox"/> V/f <input type="checkbox"/> CL-V/f <input type="checkbox"/> OLV <input type="checkbox"/> CLV <input type="checkbox"/> AOLV <input checked="" type="checkbox"/> OLV/PM <input type="checkbox"/> AOLV/PM <input type="checkbox"/> CLV/PM <input type="checkbox"/> EZOLV</p> <p>Sets the proportional gain for the automatic current regulator during Speed Estimation Speed Search. Also adjusts speed search responsiveness. Usually it is not necessary to change this setting.</p>	Determined by A1-02 and o2-04 (0.00 - 6.00)	679
b3-09 (0199)	Speed Estimation ACR I Time	<p><input type="checkbox"/> V/f <input type="checkbox"/> CL-V/f <input type="checkbox"/> OLV <input type="checkbox"/> CLV <input type="checkbox"/> AOLV <input checked="" type="checkbox"/> OLV/PM <input type="checkbox"/> AOLV/PM <input type="checkbox"/> CLV/PM <input type="checkbox"/> EZOLV</p> <p>Sets the integral time for the automatic current regulator during Speed Estimation Speed Search. Also adjusts speed search responsiveness. Usually it is not necessary to change this setting.</p>	Determined by A1-02 when A1-02 ≠ 5 20.0 when A1-02 = 5 (0.0 - 1000.0 ms)	680
b3-10 (019A) Expert	Speed Estimation Detection Gain	<p><input type="checkbox"/> V/f <input type="checkbox"/> CL-V/f <input checked="" type="checkbox"/> OLV <input type="checkbox"/> CLV <input type="checkbox"/> AOLV <input type="checkbox"/> OLV/PM <input type="checkbox"/> AOLV/PM <input type="checkbox"/> CLV/PM <input type="checkbox"/> EZOLV</p> <p>Sets the gain to correct estimated frequencies from Speed Estimation Speed Search.</p>	1.05 (1.00 - 1.20)	680

No. (Hex.)	Name	Description	Default (Range)	Ref.
b3-14 (019E)	Bi-directional Speed Search	<p>V/f CL-V/f OLV CLV AOLV OLV/PM AOLV/PM CLV/PM EZOLV</p> <p>Sets the direction of Speed Search to the direction of the frequency reference or in the motor rotation direction as detected by the drive.</p> <p>0 : Disabled 1 : Enabled</p> <p>Note:</p> <ul style="list-style-type: none"> Refer to page 590 for information about the initial value of b3-14 [Bi-directional Speed] that applies when you set these parameters: <ul style="list-style-type: none"> -A1-02 = 0, 2, 8 [Control Method Selection = V/f, OLV, EZOLV] -E9-01 = 0 [Motor Type Selection = Induction (IM)] -b3-24 = 1 [Speed Search Method Selection = Speed Estimation] The initial value of b3-14 is 0 when you set these parameters: <ul style="list-style-type: none"> -A1-02 = 0, 2, 8 -E9-01 = 0 -b3-24 = 2 [Current Detection 2] Refer to page 590 for information about the initial value of b3-14 that applies when you set these parameters: <ul style="list-style-type: none"> -A1-02 = 1, 4, 8 [CL-V/f, AOLV, EZOLV] -E9-01 = 1, 2 [Permanent Magnet (PM), Synchronous Reluctance (SynRM)] When you set A1-02, b3-24, and E9-01, set b3-14. 	Determined by A1-02 and b3-24 (0, 1)	680
b3-17 (01F0) Expert	Speed Est Retry Current Level	<p>V/f CL-V/f OLV CLV AOLV OLV/PM AOLV/PM CLV/PM EZOLV</p> <p>Sets the current level for the search retry function in Speed Estimation Speed Search as a percentage where drive rated current is a setting value of 100%.</p>	150% (0 - 200%)	680
b3-18 (01F1) Expert	Speed Est Retry Detection Time	<p>V/f CL-V/f OLV CLV AOLV OLV/PM AOLV/PM CLV/PM EZOLV</p> <p>Sets the length of time that the drive will wait to retry Speed Estimation Speed Search when too much current flow stopped the Speed Search.</p>	0.10 s (0.00 - 1.00 s)	681
b3-19 (01F2)	Speed Search Restart Attempts	<p>V/f CL-V/f OLV CLV AOLV OLV/PM AOLV/PM CLV/PM EZOLV</p> <p>Sets the number of times to restart Speed Search if Speed Search does not complete.</p>	3 times (0 - 10 times)	681
b3-24 (01C0)	Speed Search Method Selection	<p>V/f CL-V/f OLV CLV AOLV OLV/PM AOLV/PM CLV/PM EZOLV</p> <p>Sets the Speed Search method when you start the motor or when you return power after a momentary power loss.</p> <p>Note:</p> <ul style="list-style-type: none"> The default setting is different for different control methods. <ul style="list-style-type: none"> -A1-02 = 0, 2 [Control Method Selection = V/f, OLV]: 2 -A1-02 = 1 [CL-V/f]: 1 -A1-02 = 8 [EZOLV] and E9-01 = 0 [Motor Type Selection = Induction (IM)]: 2 -A1-02 = 8 and E9-01 ≠ 0: 1 Set b3-24 = 1. If b3-24 = 2, the drive will detect oPE08 [Parameter Selection Error]. 	2 (1, 2)	681
b3-25 (01C8) Expert	Speed Search Wait Time	<p>V/f CL-V/f OLV CLV AOLV OLV/PM AOLV/PM CLV/PM EZOLV</p> <p>Sets the length of time the drive will wait to start the Speed Search Retry function.</p>	0.5 s (0.0 - 30.0 s)	681
b3-26 (01C7) Expert	Direction Determination Level	<p>V/f CL-V/f OLV CLV AOLV OLV/PM AOLV/PM CLV/PM EZOLV</p> <p>Sets the level to find the motor rotation direction. Increase the value if the drive cannot find the direction.</p>	1000 (40 to 60000)	682
b3-27 (01C9) Expert	Speed Search RUN/BB Priority	<p>V/f CL-V/f OLV CLV AOLV OLV/PM AOLV/PM CLV/PM EZOLV</p> <p>Sets the conditions necessary to start Speed Search.</p> <p>0 : SS Only if RUN Applied Before BB 1 : SS Regardless of RUN/BB Sequence</p>	0 (0, 1)	682
b3-29 (077C) Expert	Speed Search Back-EMF Threshold	<p>V/f CL-V/f OLV CLV AOLV OLV/PM AOLV/PM CLV/PM EZOLV</p> <p>Sets the induced voltage for motors that use Speed Search. The drive will start Speed Search when the motor induced voltage level is the same as the setting value. Usually it is not necessary to change this setting.</p>	10% (0 - 10%)	682
b3-31 (0BC0) Expert	Spd Search Current Reference Lvl	<p>V/f CL-V/f OLV CLV AOLV OLV/PM AOLV/PM CLV/PM EZOLV</p> <p>Sets the current level that decreases the output current during Current Detection Speed Search.</p>	1.50 (1.50 - 3.50)	682
b3-32 (0BC1) Expert	Spd Search Current Complete Lvl	<p>V/f CL-V/f OLV CLV AOLV OLV/PM AOLV/PM CLV/PM EZOLV</p> <p>Sets the current level that completes Speed Search.</p>	1.20 (0.00 - 1.49)	682
b3-33 (0B3F) Expert	Speed Search during Uv Selection	<p>V/f CL-V/f OLV CLV AOLV OLV/PM AOLV/PM CLV/PM EZOLV</p> <p>Sets the function that starts Speed Search at start-up if the drive detects a Uv [Undervoltage] when it receives a Run command.</p> <p>0 : Disabled 1 : Enabled</p>	1 (0, 1)	683

11.5 b: Application

No. (Hex.)	Name	Description	Default (Range)	Ref.
b3-35 (0BC3) Expert	Low Back EMF Detection Level	V/f CL-V/f OLV CLV AOLV OLV/PM AOLV/PM CLV/PM EZOLV Sets the Low Back EMF Detection Level. Usually it is not necessary to change this setting.	10% (5 - 50%)	683
b3-36 (0BC4) Expert	High Back EMF Detection Level	V/f CL-V/f OLV CLV AOLV OLV/PM AOLV/PM CLV/PM EZOLV Sets the voltage level for Speed Search restart. Usually it is not necessary to change this setting.	0.970 (0.500 - 1.000)	683
b3-54 (3123)	Search Time	V/f CL-V/f OLV CLV AOLV OLV/PM AOLV/PM CLV/PM EZOLV Sets the length of time that the drive will run Speed Search.	400 ms (10 - 2000 ms)	683
b3-55 (3124) Expert	Current Increment Time	V/f CL-V/f OLV CLV AOLV OLV/PM AOLV/PM CLV/PM EZOLV Sets the length of time that the drive will increase the current from zero current to the setting value of b3-06 [Speed Estimation Current Level 1].	10 ms (10 - 2000 ms)	683
b3-56 (3126)	InverseRotationSearch WaitTime	V/f CL-V/f OLV CLV AOLV OLV/PM AOLV/PM CLV/PM EZOLV Sets the wait time until the drive starts inverse rotation search after it completes forward search when you do inverse rotation search during Current Detection Speed Search.	Determined by o2-04 (0.1 - 5.0 s)	684
b3-61 (1B96) Expert	Init Magnet Pole Estimation Gain	V/f CL-V/f OLV CLV AOLV OLV/PM AOLV/PM CLV/PM EZOLV Adjusts the Initial Pole Detection response gain when A1-02 = 6 [Control Method Selection = AOLV/PM]. Set b3-61 > 0.0 for a general IPM motor. The drive sets this value automatically when High Frequency Injection Tuning completes correctly. Note: • It is available when n8-35 = 1 [Initial Pole Detection Method = High Frequency Injection]. • To adjust the Initial Pole Detection response gain when A1-02 = 5, 7 [OLV/PM, CLV/PM], set n8-41 [HFI P Gain].	5.0 (-20.0 - +20.0)	684

◆ b4: Timer Function

No. (Hex.)	Name	Description	Default (Range)	Ref.
b4-01 (01A3)	Timer Function ON-Delay Time	V/f CL-V/f OLV CLV AOLV OLV/PM AOLV/PM CLV/PM EZOLV Sets the ON-delay time for the timer input.	0.0 s (0.0 - 3000.0 s)	685
b4-02 (01A4)	Timer Function OFF-Delay Time	V/f CL-V/f OLV CLV AOLV OLV/PM AOLV/PM CLV/PM EZOLV Sets the OFF-delay time for the timer input.	0.0 s (0.0 - 3000.0 s)	685
b4-03 (0B30) Expert	Terminal M1-M2 ON-Delay Time	V/f CL-V/f OLV CLV AOLV OLV/PM AOLV/PM CLV/PM EZOLV Sets the delay time until the contact is turned ON after the function set with H2-01 turns ON.	0 ms (0 - 65000 ms)	685
b4-04 (0B31) Expert	Terminal M1-M2 OFF-Delay Time	V/f CL-V/f OLV CLV AOLV OLV/PM AOLV/PM CLV/PM EZOLV Sets the delay time to deactivate the contact after the function set in H2-01 deactivates.	0 ms (0 - 65000 ms)	685
b4-05 (0B32) Expert	Terminal M3-M4 ON-Delay Time	V/f CL-V/f OLV CLV AOLV OLV/PM AOLV/PM CLV/PM EZOLV Sets the delay time to activate the contact after the function set in H2-02 activates.	0 ms (0 - 65000 ms)	685
b4-06 (0B33) Expert	Terminal M3-M4 OFF-Delay Time	V/f CL-V/f OLV CLV AOLV OLV/PM AOLV/PM CLV/PM EZOLV Sets the delay time to deactivate the contact after the function set in H2-02 deactivates.	0 ms (0 - 65000 ms)	685
b4-07 (0B34) Expert	Terminal M5-M6 ON-Delay Time	V/f CL-V/f OLV CLV AOLV OLV/PM AOLV/PM CLV/PM EZOLV Sets the delay time to activate the contact after the function set in H2-03 activates.	0 ms (0 - 65000 ms)	686
b4-08 (0B35) Expert	Terminal M5-M6 OFF-Delay Time	V/f CL-V/f OLV CLV AOLV OLV/PM AOLV/PM CLV/PM EZOLV Sets the delay time to deactivate the contact after the function set in H2-03 deactivates.	0 ms (0 - 65000 ms)	686

◆ b5: PID Control

No. (Hex.)	Name	Description	Default (Range)	Ref.
b5-01 (01A5)	PID Mode Setting	<p>V/f CL-V/f OLV CLV AOLV OLV/PM AOLV/PM CLV/PM EZOLV</p> <p>Sets the type of PID control.</p> <p>0 : Disabled 1 : Standard 2 : Standard (D on feedback) 3 : Fref + PID Trim 4 : Fref + PID Trim (D on feedback) 5 : Same as 7series & prior, b5-01=1 6 : Same as 7series & prior, b5-01=2 7 : Same as 7series & prior, b5-01=3 8 : Same as 7series & prior, b5-01=4</p> <p>Note: Use settings 5 to 8 when the drive is a replacement for a previous generation drive.</p>	0 (0 - 8)	691
b5-02 (01A6) RUN	Proportional Gain (P)	<p>V/f CL-V/f OLV CLV AOLV OLV/PM AOLV/PM CLV/PM EZOLV</p> <p>Sets the proportional gain (P) that is applied to PID input.</p>	1.00 (0.00 - 25.00)	692
b5-03 (01A7) RUN	Integral Time (I)	<p>V/f CL-V/f OLV CLV AOLV OLV/PM AOLV/PM CLV/PM EZOLV</p> <p>Sets the integral time (I) that is applied to PID input.</p>	1.0 s (0.0 - 360.0 s)	692
b5-04 (01A8) RUN	Integral Limit	<p>V/f CL-V/f OLV CLV AOLV OLV/PM AOLV/PM CLV/PM EZOLV</p> <p>Sets the upper limit for integral control (I) as a percentage of the Maximum Output Frequency.</p> <p>Note: Parameter <i>A1-02 [Control Method Selection]</i> selects which parameter is the maximum output frequency. • <i>A1-02 ≠ 8 [EZOLV]: E1-04 [Maximum Output Frequency]</i> • <i>A1-02 = 8: E9-02 [Maximum Speed]</i></p>	100.0% (0.0 - 100.0%)	692
b5-05 (01A9) RUN	Derivative Time (D)	<p>V/f CL-V/f OLV CLV AOLV OLV/PM AOLV/PM CLV/PM EZOLV</p> <p>Sets the derivative time (D) for PID control. This parameter adjusts system responsiveness.</p>	0.00 s (0.00 - 10.00 s)	693
b5-06 (01AA) RUN	PID Output Limit	<p>V/f CL-V/f OLV CLV AOLV OLV/PM AOLV/PM CLV/PM EZOLV</p> <p>Sets the maximum possible output from the PID controller as a percentage of the Maximum Output Frequency.</p> <p>Note: Parameter <i>A1-02 [Control Method Selection]</i> selects which parameter is the maximum output frequency. • <i>A1-02 ≠ 8 [EZOLV]: E1-04 [Maximum Output Frequency]</i> • <i>A1-02 = 8: E9-02 [Maximum Speed]</i></p>	100.0% (0.0 - 100.0%)	693
b5-07 (01AB) RUN	PID Offset Adjustment	<p>V/f CL-V/f OLV CLV AOLV OLV/PM AOLV/PM CLV/PM EZOLV</p> <p>Sets the offset for the PID control output as a percentage of the Maximum Output Frequency.</p> <p>Note: Parameter <i>A1-02 [Control Method Selection]</i> selects which parameter is the maximum output frequency. • <i>A1-02 ≠ 8 [EZOLV]: E1-04 [Maximum Output Frequency]</i> • <i>A1-02 = 8: E9-02 [Maximum Speed]</i></p>	0.0% (-100.0 - +100.0%)	693
b5-08 (01AC) RUN Expert	PID Primary Delay Time Constant	<p>V/f CL-V/f OLV CLV AOLV OLV/PM AOLV/PM CLV/PM EZOLV</p> <p>Sets the primary delay time constant for the PID control output. Usually it is not necessary to change this setting.</p>	0.00 s (0.00 - 10.00 s)	693
b5-09 (01AD)	PID Output Level Selection	<p>V/f CL-V/f OLV CLV AOLV OLV/PM AOLV/PM CLV/PM EZOLV</p> <p>Sets the polarity of the PID output.</p> <p>0 : Normal Output (Direct Acting) 1 : Reverse Output (Reverse Acting)</p>	0 (0, 1)	693
b5-10 (01AE) RUN	PID Output Gain Setting	<p>V/f CL-V/f OLV CLV AOLV OLV/PM AOLV/PM CLV/PM EZOLV</p> <p>Sets the amount of gain to apply to the PID output.</p>	1.00 (0.00 - 25.00)	693

11.5 b: Application

No. (Hex.)	Name	Description	Default (Range)	Ref.
b5-11 (01AF)	PID Output Reverse Selection	<p>V/f CL-V/f OLV CLV AOLV OLV/PM AOLV/PM CLV/PM EZOLV</p> <p>Sets the function that enables and disables reverse motor rotation for negative PID control output.</p> <p>0 : Lower Limit is Zero 1 : Negative Output Accepted</p>	0 (0, 1)	694
b5-12 (01B0)	Feedback Loss Detection Select	<p>V/f CL-V/f OLV CLV AOLV OLV/PM AOLV/PM CLV/PM EZOLV</p> <p>Sets the drive response to PID Feedback Low/High. Sets drive operation after the drive detects PID feedback Low/High.</p> <p>0 : Digital Out Only, Always Detect 1 : Alarm + Digital Out, Always Det 2 : Fault + Digital Out, Always Det 3 : Digital Out Only, @ PID Enable 4 : Alarm + Digital Out, @PID Enable 5 : Fault + Digital Out, @PID Enable</p>	0 (0 - 5)	694
b5-13 (01B1)	PID Feedback Loss Detection Lvl	<p>V/f CL-V/f OLV CLV AOLV OLV/PM AOLV/PM CLV/PM EZOLV</p> <p>Sets the level that triggers <i>PID Feedback Loss [FbL]</i> detection as a percentage of the Maximum Output Frequency.</p> <p>Note: Parameter <i>A1-02 [Control Method Selection]</i> selects which parameter is the maximum output frequency. • <i>A1-02 ≠ 8 [EZOLV]: E1-04 [Maximum Output Frequency]</i> • <i>A1-02 = 8: E9-02 [Maximum Speed]</i></p>	0% (0 - 100%)	695
b5-14 (01B2)	PID Feedback Loss Detection Time	<p>V/f CL-V/f OLV CLV AOLV OLV/PM AOLV/PM CLV/PM EZOLV</p> <p>Sets the length of time that PID Feedback must be less than <i>b5-13 [PID Feedback Loss Detection Lvl]</i> to detect <i>PID Feedback Loss [FbL]</i>.</p>	1.0 s (0.0 - 25.5 s)	695
b5-15 (01B3)	PID Sleep Function Start Level	<p>V/f CL-V/f OLV CLV AOLV OLV/PM AOLV/PM CLV/PM EZOLV</p> <p>Sets the output level that triggers the PID Sleep function.</p>	Determined by A1-02 (0.0 - 590.0)	695
b5-16 (01B4)	PID Sleep Delay Time	<p>V/f CL-V/f OLV CLV AOLV OLV/PM AOLV/PM CLV/PM EZOLV</p> <p>Sets a delay time to start or stop the PID Sleep function.</p>	0.0 s (0.0 - 25.5 s)	695
b5-17 (01B5) RUN	PID Accel/Decel Time	<p>V/f CL-V/f OLV CLV AOLV OLV/PM AOLV/PM CLV/PM EZOLV</p> <p>Raises or lowers the PID setpoint using the acceleration and deceleration times set to the drive. This is a soft-starter for the PID setpoint.</p>	0.0 s (0.0 - 6000.0 s)	695
b5-18 (01DC)	b5-19 PID Setpoint Selection	<p>V/f CL-V/f OLV CLV AOLV OLV/PM AOLV/PM CLV/PM EZOLV</p> <p>Sets the function that enables and disables <i>b5-19 [PID Setpoint Value]</i>.</p> <p>0 : Disabled 1 : Enabled</p>	0 (0, 1)	696
b5-19 (01DD) RUN	PID Setpoint Value	<p>V/f CL-V/f OLV CLV AOLV OLV/PM AOLV/PM CLV/PM EZOLV</p> <p>Sets the PID setpoint when <i>b5-18 = 1 [b5-19 PID Setpoint Selection = Enabled]</i>.</p>	0.00% (0.00 - 100.00%)	696
b5-20 (01E2)	PID Unit Selection	<p>V/f CL-V/f OLV CLV AOLV OLV/PM AOLV/PM CLV/PM EZOLV</p> <p>Sets the number of digits to set and show the PID setpoint.</p> <p>0 : 0.01Hz units 1 : 0.01% units 2 : rev/min 3 : User Units</p>	1 (0 - 3)	696
b5-34 (019F) RUN	PID Output Lower Limit Level	<p>V/f CL-V/f OLV CLV AOLV OLV/PM AOLV/PM CLV/PM EZOLV</p> <p>Sets the output lower limit for the PID control as a percentage of the Maximum Output Frequency.</p> <p>Note: Parameter <i>A1-02 [Control Method Selection]</i> selects which parameter is the maximum output frequency. • <i>A1-02 ≠ 8 [EZOLV]: E1-04 [Maximum Output Frequency]</i> • <i>A1-02 = 8: E9-02 [Maximum Speed]</i></p>	0.0% (-100.0 - +100.0%)	696
b5-35 (01A0) RUN	PID Input Limit Level	<p>V/f CL-V/f OLV CLV AOLV OLV/PM AOLV/PM CLV/PM EZOLV</p> <p>Sets the output upper limit for the PID control as a percentage of the Maximum Output Frequency.</p> <p>Note: Parameter <i>A1-02 [Control Method Selection]</i> selects which parameter is the maximum output frequency. • <i>A1-02 ≠ 8 [EZOLV]: E1-04 [Maximum Output Frequency]</i> • <i>A1-02 = 8: E9-02 [Maximum Speed]</i></p>	1000.0% (0.0 - 1000.0%)	697

No. (Hex.)	Name	Description	Default (Range)	Ref.
b5-36 (01A1)	PID High Feedback Detection Lvl	<p>V/f CL-V/f OLV CLV AOLV OLV/PM AOLV/PM CLV/PM EZOLV</p> <p>Sets the level that triggers <i>Excessive PID Feedback [FbH]</i> as a percentage of the Maximum Output Frequency.</p> <p>Note: Parameter <i>A1-02 [Control Method Selection]</i> selects which parameter is the maximum output frequency. • <i>A1-02 ≠ 8 [EZOLV]: E1-04 [Maximum Output Frequency]</i> • <i>A1-02 = 8: E9-02 [Maximum Speed]</i></p>	100% (0 - 100%)	697
b5-37 (01A2)	PID High Feedback Detection Time	<p>V/f CL-V/f OLV CLV AOLV OLV/PM AOLV/PM CLV/PM EZOLV</p> <p>Sets the length of time that the PID feedback signal must be more than the level set in <i>b5-36 [PID Feedback High Detection Lvl]</i> to cause <i>Excessive PID Feedback [FbH]</i>.</p>	1.0 s (0.0 - 25.5 s)	697
b5-38 (01FE)	PID User Unit Display Scaling	<p>V/f CL-V/f OLV CLV AOLV OLV/PM AOLV/PM CLV/PM EZOLV</p> <p>Sets the value that the drive sets or shows as the PID setpoint when at the maximum output frequency.</p>	Determined by b5-20 (1 - 60000)	697
b5-39 (01FF)	PID User Unit Display Digits	<p>V/f CL-V/f OLV CLV AOLV OLV/PM AOLV/PM CLV/PM EZOLV</p> <p>Sets the number of digits to set and show the PID setpoint. 0 : No Decimal Places (XXXXX) 1 : One Decimal Places (XXXX.X) 2 : Two Decimal Places (XXX.XX) 3 : Three Decimal Places (XX.XXX)</p>	Determined by b5-20 (0 - 3)	697
b5-40 (017F)	Frequency Reference Monitor @PID	<p>V/f CL-V/f OLV CLV AOLV OLV/PM AOLV/PM CLV/PM EZOLV</p> <p>Sets the contents for monitor <i>U1-01 [Frequency Reference]</i> in PID control. 0 : U1-01 Includes PID Output 1 : U1-01 Excludes PID Output</p>	0 (0, 1)	698
b5-47 (017D)	PID Trim Mode Output Reverse Sel	<p>V/f CL-V/f OLV CLV AOLV OLV/PM AOLV/PM CLV/PM EZOLV</p> <p>Sets reverse motor rotation when the PID control output is negative. 0 : Lower Limit is Zero 1 : Negative Output Accepted</p>	1 (0, 1)	698
b5-53 (0B8F) RUN	PID Integrator Ramp Limit	<p>V/f CL-V/f OLV CLV AOLV OLV/PM AOLV/PM CLV/PM EZOLV</p> <p>Sets the responsiveness of PID control when the PID feedback changes quickly.</p>	0.0 Hz (0.0 - 10.0 Hz)	698
b5-55 (0BE1)	PID Feedback Monitor Selection	<p>V/f CL-V/f OLV CLV AOLV OLV/PM AOLV/PM CLV/PM EZOLV</p> <p>Sets the monitor (<i>Ux-xx</i>) used as the PID Feedback. Set the <i>x-xx</i> part of the <i>Ux-xx [Monitor]</i>.</p>	000 (000 - 999)	698
b5-56 (0BE2)	PID Feedback Monitor Gain	<p>V/f CL-V/f OLV CLV AOLV OLV/PM AOLV/PM CLV/PM EZOLV</p> <p>Sets the gain for the monitor set in <i>b5-55 [PID Feedback Monitor Selection]</i>.</p>	1.00 (0.00 - 10.00)	699
b5-57 (11DD)	PID Feedback Monitor Bias	<p>V/f CL-V/f OLV CLV AOLV OLV/PM AOLV/PM CLV/PM EZOLV</p> <p>Sets the bias for the monitor specified in <i>b5-55 [PID Feedback Monitor Selection]</i>.</p>	0.00 (-10.00 - +10.00)	699
b5-58 to b5-60: (1182 - 1184) RUN	PID Setpoints 2 to 4	<p>V/f CL-V/f OLV CLV AOLV OLV/PM AOLV/PM CLV/PM EZOLV</p> <p>Sets the PID setpoint when <i>H1-xx = 3E or 3F [MFDI Function Selection = PID Setpoint Selection 1/2]</i>. This value is a percentage of the maximum output frequency.</p> <p>Note: Parameter <i>A1-02 [Control Method Selection]</i> selects which parameter is the maximum output frequency. • <i>A1-02 ≠ 8 [EZOLV]: E1-04 [Maximum Output Frequency]</i> • <i>A1-02 = 8: E9-02 [Maximum Speed]</i></p>	0.00% (0.00 - 100.00%)	699
b5-61 (119A)	PID Trim Mode Lower Limit Sel	<p>V/f CL-V/f OLV CLV AOLV OLV/PM AOLV/PM CLV/PM EZOLV</p> <p>Sets the function that adjusts the PID output in relation to the frequency reference. 0 : Disabled 1 : Enabled</p>	0 (0, 1)	699
b5-62 (119B)	PID Trim Mode Lower Limit Value	<p>V/f CL-V/f OLV CLV AOLV OLV/PM AOLV/PM CLV/PM EZOLV</p> <p>Sets the PID Trim Mode Lower Limit Value as a percentage of the maximum output frequency.</p> <p>Note: Parameter <i>A1-02 [Control Method Selection]</i> selects which parameter is the maximum output frequency. • <i>A1-02 ≠ 8 [EZOLV]: E1-04 [Maximum Output Frequency]</i> • <i>A1-02 = 8: E9-02 [Maximum Speed]</i></p>	0.00% (0.00 - 100.00%)	700
b5-63 (119C)	PID Differential FB Monitor Sel	<p>V/f CL-V/f OLV CLV AOLV OLV/PM AOLV/PM CLV/PM EZOLV</p> <p>Selects the monitor (<i>Ux-xx</i>) used as the PID Differential Feedback. Set the <i>x-xx</i> part of the <i>Ux-xx [Monitor]</i>.</p>	000 (000 - 999)	700
b5-64 (119D)	PID Differential FB Monitor Gain	<p>V/f CL-V/f OLV CLV AOLV OLV/PM AOLV/PM CLV/PM EZOLV</p> <p>Sets the gain for the monitor specified in <i>b5-63 [PID Differential FB Monitor Sel]</i>.</p>	1.00 (0.00 - 10.00)	700

11.5 b: Application

No. (Hex.)	Name	Description	Default (Range)	Ref.
b5-65 (119F)	PID Differential FB Monitor Bias	V/f CL-V/f OLV CLV AOLV OLV/PM AOLV/PM CLV/PM EZOLV Sets the bias for the monitor specified in b5-63 [PID Differential FB Monitor Sel].	0.00 (-10.00 - +10.00)	700
b5-66 (11DE)	PID Feedback Monitor Level	V/f CL-V/f OLV CLV AOLV OLV/PM AOLV/PM CLV/PM EZOLV Sets the signal level for the monitor specified in b5-55 [PID Feedback Monitor Selection]. 0 : Absolute 1 : Bi-directional (+/-)	0 (0, 1)	700
b5-67 (11DF)	PID Differential FB Monitor Lvl	V/f CL-V/f OLV CLV AOLV OLV/PM AOLV/PM CLV/PM EZOLV Sets the signal level for the monitor specified in b5-63 [PID Differential FB Monitor Sel]. 0 : Absolute 1 : Bi-directional (+/-)	0 (0, 1)	700
b5-89 (0B89) RUN	Sleep Method Selection	V/f CL-V/f OLV CLV AOLV OLV/PM AOLV/PM CLV/PM EZOLV Sets sleep and wake up operation when using PID. 0 : Standard 1 : EZ Sleep/Wake-up	0 (0, 1)	700
b5-90 (0B90)	EZ Sleep Unit	V/f CL-V/f OLV CLV AOLV OLV/PM AOLV/PM CLV/PM EZOLV Sets the measurement units for b5-91 [EZ Sleep Minimum Speed] and b5-92 [EZ Sleep Level]. 0 : 0.1Hz units 1 : rev/min	0 (0, 1)	701
b5-91 (0B91) RUN	EZ Sleep Minimum Speed	V/f CL-V/f OLV CLV AOLV OLV/PM AOLV/PM CLV/PM EZOLV Sets the minimum speed for the EZ Sleep/Wakeup function. This parameter uses the largest value from b5-91, b5-34 [PID Output Lower Limit Level], and d2-02 [Frequency Reference Lower Limit].	0.0 Hz or 0 min ⁻¹ (r/min) (0.0 to 590.0 Hz or 0 to 35400 min ⁻¹ (r/min))	701
b5-92 (0B92) RUN	EZ Sleep Level	V/f CL-V/f OLV CLV AOLV OLV/PM AOLV/PM CLV/PM EZOLV Sets the value that the output frequency or motor speed must be less than for longer than b5-93 [EZ Sleep Time] to enter Sleep Mode.	0.0 Hz or 0 min ⁻¹ (r/min) (0.0 to 590.0 Hz or 0 to 35400 min ⁻¹ (r/min))	701
b5-93 (0B93) RUN	EZ Sleep Time	V/f CL-V/f OLV CLV AOLV OLV/PM AOLV/PM CLV/PM EZOLV Sets the length of time that the output frequency or motor speed must be less than b5-92 [EZ Sleep Level] to enter Sleep Mode.	5.0 s (0.0 - 1000.0 s)	701
b5-94 (0B94) RUN	EZ Sleep Wake-up Level	V/f CL-V/f OLV CLV AOLV OLV/PM AOLV/PM CLV/PM EZOLV Sets the level at which the drive resumes operation when exiting Sleep Mode.	0.00% (0.00 - 600.00%)	701
b5-95 (0B95)	EZ Sleep Wake-up Mode	V/f CL-V/f OLV CLV AOLV OLV/PM AOLV/PM CLV/PM EZOLV Sets the wake-up mode to use when exiting Sleep Mode. 0 : Absolute 1 : Setpoint Delta	0 (0, 1)	702
b5-96 (0B96) RUN	EZ Sleep Wake-up Time	V/f CL-V/f OLV CLV AOLV OLV/PM AOLV/PM CLV/PM EZOLV Sets the EZ Wake-up time.	1.0 s (0.0 - 1000.0 s)	702

◆ b6: Dwell Function

No. (Hex.)	Name	Description	Default (Range)	Ref.
b6-01 (01B6)	Dwell Reference at Start	V/f CL-V/f OLV CLV AOLV OLV/PM AOLV/PM CLV/PM EZOLV Sets the output frequency that the drive will hold momentarily when the motor starts.	0.0 (Determined by A1-02)	702
b6-02 (01B7)	Dwell Time at Start	V/f CL-V/f OLV CLV AOLV OLV/PM AOLV/PM CLV/PM EZOLV Sets the length of time that the drive will hold the output frequency when the motor starts.	0.0 s (0.0 - 10.0 s)	703
b6-03 (01B8)	Dwell Reference at Stop	V/f CL-V/f OLV CLV AOLV OLV/PM AOLV/PM CLV/PM EZOLV Sets the output frequency that the drive will hold momentarily when ramping to stop the motor.	0.0 (Determined by A1-02)	703
b6-04 (01B9)	Dwell Time at Stop	V/f CL-V/f OLV CLV AOLV OLV/PM AOLV/PM CLV/PM EZOLV Sets the length of time for the drive to hold the output frequency when ramping to stop the motor.	0.0 s (0.0 - 10.0 s)	703

◆ b7: Droop Control

No. (Hex.)	Name	Description	Default (Range)	Ref.
b7-01 (01CA) RUN	Droop Control Gain	<input type="checkbox"/> V/f <input type="checkbox"/> CL-V/f <input type="checkbox"/> OLV <input checked="" type="checkbox"/> CLV <input type="checkbox"/> AOLV <input type="checkbox"/> OLV/PM <input type="checkbox"/> AOLV/PM <input type="checkbox"/> CLV/PM <input type="checkbox"/> EZOLV Sets the amount of deceleration when the torque reference is at 100% as a percentage of E1-04 [Maximum Output Frequency].	0.0% (0.0 - 100.0%)	704
b7-02 (01CB) RUN	Droop Control Delay Time	<input type="checkbox"/> V/f <input type="checkbox"/> CL-V/f <input type="checkbox"/> OLV <input checked="" type="checkbox"/> CLV <input type="checkbox"/> AOLV <input type="checkbox"/> OLV/PM <input type="checkbox"/> AOLV/PM <input type="checkbox"/> CLV/PM <input type="checkbox"/> EZOLV Sets the responsiveness of Droop control. Decrease this setting when drive response is slow. Increase this setting when hunting or oscillation occur.	0.05 s (0.03 - 2.00 s)	704
b7-03 (017E)	Droop Control Limit Selection	<input type="checkbox"/> V/f <input type="checkbox"/> CL-V/f <input type="checkbox"/> OLV <input checked="" type="checkbox"/> CLV <input type="checkbox"/> AOLV <input type="checkbox"/> OLV/PM <input type="checkbox"/> AOLV/PM <input type="checkbox"/> CLV/PM <input type="checkbox"/> EZOLV Sets the Droop control limit function. 0 : Disabled 1 : Enabled	1 (0, 1)	704

◆ b8: Energy Saving

No. (Hex.)	Name	Description	Default (Range)	Ref.
b8-01 (01CC)	Energy Saving Control Selection	<input type="checkbox"/> V/f <input type="checkbox"/> CL-V/f <input type="checkbox"/> OLV <input checked="" type="checkbox"/> CLV <input type="checkbox"/> AOLV <input type="checkbox"/> OLV/PM <input type="checkbox"/> AOLV/PM <input type="checkbox"/> CLV/PM <input type="checkbox"/> EZOLV Sets the Energy-saving control function. 0 : Disabled 1 : Enabled 2 : Automatic Optimization Note: Setting 2 is available only when A1-02 = 6, 7 [Control Method Selection = AOLV/PM, CLV/PM] and in Expert Mode.	0 (0 - 2)	704
b8-02 (01CD) RUN Expert	Energy Saving Gain	<input type="checkbox"/> V/f <input type="checkbox"/> CL-V/f <input type="checkbox"/> OLV <input checked="" type="checkbox"/> CLV <input type="checkbox"/> AOLV <input type="checkbox"/> OLV/PM <input type="checkbox"/> AOLV/PM <input type="checkbox"/> CLV/PM <input type="checkbox"/> EZOLV Sets the gain for Energy-saving control.	Determined by A1-02 (0.0 - 10.0)	705
b8-03 (01CE) RUN Expert	Energy Saving Filter Time	<input type="checkbox"/> V/f <input type="checkbox"/> CL-V/f <input type="checkbox"/> OLV <input checked="" type="checkbox"/> CLV <input type="checkbox"/> AOLV <input type="checkbox"/> OLV/PM <input type="checkbox"/> AOLV/PM <input type="checkbox"/> CLV/PM <input type="checkbox"/> EZOLV Sets the responsiveness for Energy-saving control.	Determined by A1-02 , C6-01 and o2-04 (0.00 - 10.00 s)	705
b8-04 (01CF) Expert	Energy Saving Coefficient Value	<input type="checkbox"/> V/f <input type="checkbox"/> CL-V/f <input type="checkbox"/> OLV <input checked="" type="checkbox"/> CLV <input type="checkbox"/> AOLV <input type="checkbox"/> OLV/PM <input type="checkbox"/> AOLV/PM <input type="checkbox"/> CLV/PM <input type="checkbox"/> EZOLV Sets the Energy-saving control coefficient to maintain maximum motor efficiency. The default setting is for Yaskawa motors.	Determined by C6-01, E2-11, and o2-04 (0.00 - 655.00)	705
b8-05 (01D0) Expert	Power Detection Filter Time	<input type="checkbox"/> V/f <input type="checkbox"/> CL-V/f <input type="checkbox"/> OLV <input checked="" type="checkbox"/> CLV <input type="checkbox"/> AOLV <input type="checkbox"/> OLV/PM <input type="checkbox"/> AOLV/PM <input type="checkbox"/> CLV/PM <input type="checkbox"/> EZOLV Sets the time constant to measure output power.	20 ms (0 - 2000 ms)	705
b8-06 (01D1) Expert	Search Operation Voltage Limit	<input type="checkbox"/> V/f <input type="checkbox"/> CL-V/f <input type="checkbox"/> OLV <input checked="" type="checkbox"/> CLV <input type="checkbox"/> AOLV <input type="checkbox"/> OLV/PM <input type="checkbox"/> AOLV/PM <input type="checkbox"/> CLV/PM <input type="checkbox"/> EZOLV Sets the voltage limit for Search Operation as a percentage of the motor rated voltage.	0% (0 - 100%)	705
b8-16 (01F8) Expert	PM E-Save Coefficient Ki	<input type="checkbox"/> V/f <input type="checkbox"/> CL-V/f <input type="checkbox"/> OLV <input type="checkbox"/> CLV <input type="checkbox"/> AOLV <input type="checkbox"/> OLV/PM <input checked="" type="checkbox"/> AOLV/PM <input type="checkbox"/> CLV/PM <input type="checkbox"/> EZOLV Sets torque linearity. This parameter uses the Ki value from the motor nameplate. Usually it is not necessary to change this setting.	1.00 (0.00 - 3.00)	706
b8-17 (01F9) Expert	PM E-Save Coefficient Kt	<input type="checkbox"/> V/f <input type="checkbox"/> CL-V/f <input type="checkbox"/> OLV <input type="checkbox"/> CLV <input type="checkbox"/> AOLV <input type="checkbox"/> OLV/PM <input checked="" type="checkbox"/> AOLV/PM <input type="checkbox"/> CLV/PM <input type="checkbox"/> EZOLV Sets torque linearity. This parameter uses the Kt value from the motor nameplate. Usually it is not necessary to change this setting.	1.00 (0.00 - 3.00)	706
b8-18 (01FA) Expert	E-Save d-axis Current FilterTime	<input type="checkbox"/> V/f <input type="checkbox"/> CL-V/f <input type="checkbox"/> OLV <input type="checkbox"/> CLV <input type="checkbox"/> AOLV <input type="checkbox"/> OLV/PM <input checked="" type="checkbox"/> AOLV/PM <input type="checkbox"/> CLV/PM <input type="checkbox"/> EZOLV Sets the d-axis current reference filter time constant.	0.100 s (0.000 - 5.000 s)	706
b8-19 (0B40) Expert	E-Save Search Frequency	<input type="checkbox"/> V/f <input type="checkbox"/> CL-V/f <input type="checkbox"/> OLV <input type="checkbox"/> CLV <input type="checkbox"/> AOLV <input type="checkbox"/> OLV/PM <input checked="" type="checkbox"/> AOLV/PM <input type="checkbox"/> CLV/PM <input type="checkbox"/> EZOLV Sets the frequency of Energy-saving control search operations. Usually it is not necessary to change this setting.	Determined by A1-02 (10 - 300 Hz)	706
b8-20 (0B41) Expert	E-Save Search Width	<input type="checkbox"/> V/f <input type="checkbox"/> CL-V/f <input type="checkbox"/> OLV <input type="checkbox"/> CLV <input type="checkbox"/> AOLV <input type="checkbox"/> OLV/PM <input checked="" type="checkbox"/> AOLV/PM <input type="checkbox"/> CLV/PM <input type="checkbox"/> EZOLV Sets the amplitude of Energy-saving control search operations.	1.0 degrees (0.1 - 5.0 degrees)	707

11.5 b: Application

No. (Hex.)	Name	Description	Default (Range)	Ref.
b8-21 (0B42) Expert	PM E-Save Search Gain	<input type="checkbox"/> V/f <input type="checkbox"/> CL-V/f <input type="checkbox"/> OLV <input type="checkbox"/> CLV <input type="checkbox"/> AOLV <input type="checkbox"/> OLV/PM <input type="checkbox"/> AOLV/PM <input type="checkbox"/> CLV/PM <input type="checkbox"/> EZOLV Sets the gain of Energy-saving control search operations.	0.3Hz (0.1 - 20.0 Hz)	707
b8-22 (0B43) Expert	PM E-Save Search LPF Cutoff Freq	<input type="checkbox"/> V/f <input type="checkbox"/> CL-V/f <input type="checkbox"/> OLV <input type="checkbox"/> CLV <input type="checkbox"/> AOLV <input type="checkbox"/> OLV/PM <input type="checkbox"/> AOLV/PM <input type="checkbox"/> CLV/PM <input type="checkbox"/> EZOLV Sets the frequency of the filter used to extract the high-efficiency phase from search operations. Usually it is not necessary to change this setting.	10.0 Hz (1.0 - 30.0 Hz)	707
b8-23 (0B44) Expert	PM E-Save Search Limit	<input type="checkbox"/> V/f <input type="checkbox"/> CL-V/f <input type="checkbox"/> OLV <input type="checkbox"/> CLV <input type="checkbox"/> AOLV <input type="checkbox"/> OLV/PM <input type="checkbox"/> AOLV/PM <input type="checkbox"/> CLV/PM <input type="checkbox"/> EZOLV Sets the search operations output limit. Usually it is not necessary to change this setting.	15.0 degrees (0.0 - 30.0 degrees)	707
b8-24 (0B45) Expert	PM E-Save High Freq ACR Gain	<input type="checkbox"/> V/f <input type="checkbox"/> CL-V/f <input type="checkbox"/> OLV <input type="checkbox"/> CLV <input type="checkbox"/> AOLV <input type="checkbox"/> OLV/PM <input type="checkbox"/> AOLV/PM <input type="checkbox"/> CLV/PM <input type="checkbox"/> EZOLV Sets the gain for high-frequency current control.	200.0 Hz (100.0 - 1000.0 Hz)	707
b8-25 (0B46) Expert	PM E-Save Search Start Level	<input type="checkbox"/> V/f <input type="checkbox"/> CL-V/f <input type="checkbox"/> OLV <input type="checkbox"/> CLV <input type="checkbox"/> AOLV <input type="checkbox"/> OLV/PM <input type="checkbox"/> AOLV/PM <input type="checkbox"/> CLV/PM <input type="checkbox"/> EZOLV Sets the start level for search operations.	10.0% (0.0 - 100.0%)	707
b8-26 (0B47) Expert	PM E-Save Power Setpoint	<input type="checkbox"/> V/f <input type="checkbox"/> CL-V/f <input type="checkbox"/> OLV <input type="checkbox"/> CLV <input type="checkbox"/> AOLV <input type="checkbox"/> OLV/PM <input type="checkbox"/> AOLV/PM <input type="checkbox"/> CLV/PM <input type="checkbox"/> EZOLV Sets a value to increase torque accuracy.	0.0% (-10.0 - +10.0%)	708
b8-28 (0B8B) Expert	Over Excitation Action Selection	<input type="checkbox"/> V/f <input type="checkbox"/> CL-V/f <input type="checkbox"/> OLV <input type="checkbox"/> CLV <input type="checkbox"/> AOLV <input type="checkbox"/> OLV/PM <input type="checkbox"/> AOLV/PM <input type="checkbox"/> CLV/PM <input type="checkbox"/> EZOLV Sets the function for excitation operation. 0 : Disabled 1 : Enabled	0 (0, 1)	708
b8-29 (0B8C)	Energy Saving Priority Selection	<input type="checkbox"/> V/f <input type="checkbox"/> CL-V/f <input type="checkbox"/> OLV <input type="checkbox"/> CLV <input type="checkbox"/> AOLV <input type="checkbox"/> OLV/PM <input type="checkbox"/> AOLV/PM <input type="checkbox"/> CLV/PM <input type="checkbox"/> EZOLV Sets the priority of drive response between changes to the load or Energy-saving control. Enable this to prioritize energy-saving control. Disable this to prioritize tracking related to fast load changes, and prevent motor stall. 0 : Priority: Drive Response 1 : Priority: Energy Savings	0 (0, 1)	708
b8-50 (0B0D)	Standby Mode Selection	<input type="checkbox"/> V/f <input type="checkbox"/> CL-V/f <input type="checkbox"/> OLV <input type="checkbox"/> CLV <input type="checkbox"/> AOLV <input type="checkbox"/> OLV/PM <input type="checkbox"/> AOLV/PM <input type="checkbox"/> CLV/PM <input type="checkbox"/> EZOLV Sets the Standby Mode function. 0 : Disabled 1 : Enabled	0 (0, 1)	708
b8-51 (0B01)	Standby Mode Wait Time	<input type="checkbox"/> V/f <input type="checkbox"/> CL-V/f <input type="checkbox"/> OLV <input type="checkbox"/> CLV <input type="checkbox"/> AOLV <input type="checkbox"/> OLV/PM <input type="checkbox"/> AOLV/PM <input type="checkbox"/> CLV/PM <input type="checkbox"/> EZOLV Sets the delay time before turning off the electromagnetic contactor after the drive stops.	600 s (0 - 6000 s)	709

◆ b9: Zero Servo

No. (Hex.)	Name	Description	Default (Range)	Ref.
b9-01 (01DA)	Zero Servo Gain	<input type="checkbox"/> V/f <input type="checkbox"/> CL-V/f <input type="checkbox"/> OLV <input checked="" type="checkbox"/> CLV <input type="checkbox"/> AOLV <input type="checkbox"/> OLV/PM <input type="checkbox"/> AOLV/PM <input type="checkbox"/> CLV/PM <input type="checkbox"/> EZOLV Sets the responsiveness for the Zero Servo function.	5 (0 - 100)	710
b9-02 (01DB)	Zero Servo Completion Window	<input type="checkbox"/> V/f <input type="checkbox"/> CL-V/f <input type="checkbox"/> OLV <input checked="" type="checkbox"/> CLV <input type="checkbox"/> AOLV <input type="checkbox"/> OLV/PM <input type="checkbox"/> AOLV/PM <input type="checkbox"/> CLV/PM <input type="checkbox"/> EZOLV Sets the range to trigger an output terminal set for "Zero Servo Complete" during Zero Servo operation. Be sure to set the deviation from the Zero Servo start position.	10 (0 - 16383)	710

11.6 C: Tuning

◆ C1: Accel & Decel Time

No. (Hex.)	Name	Description	Default (Range)	Ref.
C1-01 (0200) RUN	Acceleration Time 1	V/f CL-V/f OLV CLV AOLV OLV/PM AOLV/PM CLV/PM EZOLV Sets the length of time to accelerate from zero to maximum output frequency.	10.0 s (0.0 - 6000.0 s)	713
C1-02 (0201) RUN	Deceleration Time 1	V/f CL-V/f OLV CLV AOLV OLV/PM AOLV/PM CLV/PM EZOLV Sets the length of time to decelerate from maximum output frequency to zero.	10.0 s (0.0 - 6000.0 s)	713
C1-03 (0202) RUN	Acceleration Time 2	V/f CL-V/f OLV CLV AOLV OLV/PM AOLV/PM CLV/PM EZOLV Sets the length of time to accelerate from zero to maximum output frequency.	10.0 s (0.0 - 6000.0 s)	713
C1-04 (0203) RUN	Deceleration Time 2	V/f CL-V/f OLV CLV AOLV OLV/PM AOLV/PM CLV/PM EZOLV Sets the length of time to decelerate from maximum output frequency to zero.	10.0 s (0.0 - 6000.0 s)	713
C1-05 (0204) RUN	Acceleration Time 3	V/f CL-V/f OLV CLV AOLV OLV/PM AOLV/PM CLV/PM EZOLV Sets the length of time to accelerate from zero to maximum output frequency.	10.0 s (0.0 - 6000.0 s)	713
C1-06 (0205) RUN	Deceleration Time 3	V/f CL-V/f OLV CLV AOLV OLV/PM AOLV/PM CLV/PM EZOLV Sets the length of time to decelerate from maximum output frequency to zero.	10.0 s (0.0 - 6000.0 s)	713
C1-07 (0206) RUN	Acceleration Time 4	V/f CL-V/f OLV CLV AOLV OLV/PM AOLV/PM CLV/PM EZOLV Sets the length of time to accelerate from zero to maximum output frequency.	10.0 s (0.0 - 6000.0 s)	714
C1-08 (0207) RUN	Deceleration Time 4	V/f CL-V/f OLV CLV AOLV OLV/PM AOLV/PM CLV/PM EZOLV Sets the length of time to decelerate from maximum output frequency to zero.	10.0 s (0.0 - 6000.0 s)	714
C1-09 (0208) RUN	Fast Stop Time	V/f CL-V/f OLV CLV AOLV OLV/PM AOLV/PM CLV/PM EZOLV Sets the length of time that the drive will decelerate to zero for a Fast Stop. Note: • Decelerating too quickly can cause an <i>ov</i> [Overvoltage] fault that shuts off the drive while the motor to coasts to a stop. Set a Fast Stop time in <i>C1-09</i> that prevents motor coasting and makes sure that the motor stops quickly and safely. • When <i>L2-29 = 0</i> [Kinetic Energy Backup Method = Single Drive KEB Ride-Thru 1] and you do KEB Auto-Tuning, the drive will automatically set <i>C1-09</i> . If you must not change the Fast Stop time, do not do KEB Tuning.	10.0 s (0.0 - 6000.0 s)	714
C1-10 (0209)	Accel/Decel Time Setting Units	V/f CL-V/f OLV CLV AOLV OLV/PM AOLV/PM CLV/PM EZOLV Sets the setting units for <i>C1-01</i> to <i>C1-08</i> [Accel/Decel Times 1 to 4], <i>C1-09</i> [Fast Stop Time], <i>L2-06</i> [Kinetic Energy Backup Decel Time], and <i>L2-07</i> [Kinetic Energy Backup Accel Time]. 0 : 0.01 s (0.00 to 600.00 s) 1 : 0.1 s (0.0 to 6000.0 s)	1 (0, 1)	714
C1-11 (020A)	Accel/Decel Time Switching Frequency	V/f CL-V/f OLV CLV AOLV OLV/PM AOLV/PM CLV/PM EZOLV Sets the frequency at which the drive will automatically change acceleration and deceleration times.	Determined by A1-02 (0.0 - 590.0 Hz)	715
C1-14 (0264) RUN	Accel/Decel Rate Frequency	V/f CL-V/f OLV CLV AOLV OLV/PM AOLV/PM CLV/PM EZOLV Sets the base frequency used to calculate acceleration and deceleration rates.	0.0 Hz (0.0 - 590.0 Hz)	715

◆ C2: S-Curve Characteristics

No. (Hex.)	Name	Description	Default (Range)	Ref.
C2-01 (020B)	S-Curve Time @ Start of Accel	V/f CL-V/f OLV CLV AOLV OLV/PM AOLV/PM CLV/PM EZOLV Sets the S-curve acceleration time at start.	Determined by A1-02 (0.00 - 10.00 s)	717
C2-02 (020C)	S-Curve Time @ End of Accel	V/f CL-V/f OLV CLV AOLV OLV/PM AOLV/PM CLV/PM EZOLV Sets the S-curve acceleration time at completion.	0.20 s (0.00 - 10.00 s)	717

No. (Hex.)	Name	Description	Default (Range)	Ref.
C2-03 (020D)	S-Curve Time @ Start of Decel	V/f CL-V/f OLV CLV AOLV OLV/PM AOLV/PM CLV/PM EZOLV Sets the S-curve deceleration time at start.	0.20 s (0.00 - 10.00 s)	717
C2-04 (020E)	S-Curve Time @ End of Decel	V/f CL-V/f OLV CLV AOLV OLV/PM AOLV/PM CLV/PM EZOLV Sets the S-curve deceleration time at completion.	0.00 s (0.00 - 10.00 s)	717

◆ C3: Slip Compensation

No. (Hex.)	Name	Description	Default (Range)	Ref.
C3-01 (020F) RUN	Slip Compensation Gain	V/f CL-V/f OLV CLV AOLV OLV/PM AOLV/PM CLV/PM EZOLV Sets the gain for the slip compensation function. Usually it is not necessary to change this setting. Note: Correctly set these parameters before changing the slip compensation gain: • E2-01 [Motor Rated Current (FLA)] • E2-02 [Motor Rated Slip] • E2-03 [Motor No-Load Current]	Determined by A1-02 (0.0 - 2.5)	718
C3-02 (0210) RUN	Slip Compensation Delay Time	V/f CL-V/f OLV CLV AOLV OLV/PM AOLV/PM CLV/PM EZOLV Sets the slip compensation delay time when speed is unstable or when the slip compensation response is too slow. Usually it is not necessary to change this setting.	Determined by A1-02 (0 - 10000 ms)	718
C3-03 (0211)	Slip Compensation Limit	V/f CL-V/f OLV CLV AOLV OLV/PM AOLV/PM CLV/PM EZOLV Sets the upper limit for the slip compensation function as a percentage of the motor rated slip.	200% (0 - 250%)	718
C3-04 (0212)	Slip Compensation at Regen	V/f CL-V/f OLV CLV AOLV OLV/PM AOLV/PM CLV/PM EZOLV Sets the slip compensation function during regenerative operation. 0 : Disabled 1 : Enabled Above 6Hz 2 : Enabled Above C3-15	0 (0 - 2)	719
C3-05 (0213)	Output Voltage Limit Selection	V/f CL-V/f OLV CLV AOLV OLV/PM AOLV/PM CLV/PM EZOLV Sets the automatic reduction of motor magnetic flux when the output voltage is saturated. 0 : Disabled 1 : Enabled	0 (0, 1)	719
C3-16 (0261) Expert	Vout Modulation Limit Start Lvl	V/f CL-V/f OLV CLV AOLV OLV/PM AOLV/PM CLV/PM EZOLV Sets the modulation factor that starts the output voltage limit operation when C3-05 = 1 [Output Voltage Limit Selection = Enabled].	90.0% (70.0 - 90.0%)	720
C3-17 (0262) Expert	Vout Modulation Limit Max Level	V/f CL-V/f OLV CLV AOLV OLV/PM AOLV/PM CLV/PM EZOLV Sets the modulation factor used with C3-18 [Output Voltage Limit Level] for the output voltage limit operation when C3-05 = 1 [Output Voltage Limit Selection = Enabled].	100.0% (85.0 - 100.0%)	720
C3-18 (0263) Expert	Output Voltage Limit Level	V/f CL-V/f OLV CLV AOLV OLV/PM AOLV/PM CLV/PM EZOLV Sets the maximum drop width of the voltage reference when C3-05 = 1 [Output Voltage Limit Selection = Enabled].	90.0% (50.0 - 100.0%)	720
C3-21 (033E) RUN	Motor 2 Slip Compensation Gain	V/f CL-V/f OLV CLV AOLV OLV/PM AOLV/PM CLV/PM EZOLV Sets the gain for the motor 2 slip compensation function. Usually it is not necessary to change this setting. Note: Correctly set these parameters before changing the slip compensation gain: • E4-01 [Motor 2 Rated Current] • E4-02 [Motor 2 Rated Slip] • E4-03 [Motor 2 Rated No-Load Current]	Determined by E3-01 (0.0 - 2.5)	720
C3-22 (0241) RUN	Motor 2 Slip Comp Delay Time	V/f CL-V/f OLV CLV AOLV OLV/PM AOLV/PM CLV/PM EZOLV Sets the slip compensation delay time for motor 2 when speed is unstable or when the slip compensation response is too slow. Usually it is not necessary to change this setting.	Determined by E3-01 (0 - 10000 ms)	720
C3-23 (0242)	Motor 2 Slip Compensation Limit	V/f CL-V/f OLV CLV AOLV OLV/PM AOLV/PM CLV/PM EZOLV Sets the upper limit for the slip compensation function as a percentage of the motor 2 rated slip.	200% (0 - 250%)	720

No. (Hex.)	Name	Description	Default (Range)	Ref.
C3-24 (0243)	Motor 2 Slip Comp during Regen	<p>V/f CL-V/f OLV CLV AOLV OLV/PM AOLV/PM CLV/PM EZOLV</p> <p>Sets the slip compensation during regenerative operation function for motor 2. 0 : Disabled 1 : Enabled Above 6Hz 2 : Enabled Above C3-15</p>	0 (0 - 2)	721
C3-28 (1B5B) Expert	Adaptive Slip Control Mode	<p>V/f CL-V/f OLV CLV AOLV OLV/PM AOLV/PM CLV/PM EZOLV</p> <p>Sets the slip compensation function mode. 0 : Normal 1 : Advanced</p>	0 (0, 1)	721

◆ C4: Torque Compensation

No. (Hex.)	Name	Description	Default (Range)	Ref.
C4-01 (0215) RUN	Torque Compensation Gain	<p>V/f CL-V/f OLV CLV AOLV OLV/PM AOLV/PM CLV/PM EZOLV</p> <p>Sets the gain for the torque compensation function. Use this parameter value for motor 1 when operating multiple motors. Note: If $A1-02 = 8$ [Control Method Selection = EZOLV], you cannot change the setting while the drive is running.</p>	Determined by A1-02 (0.00 - 2.50)	722
C4-02 (0216) RUN	Torque Compensation Delay Time	<p>V/f CL-V/f OLV CLV AOLV OLV/PM AOLV/PM CLV/PM EZOLV</p> <p>Sets the torque compensation delay time. Usually it is not necessary to change this setting. Note: If $A1-02 = 8$ [Control Method Selection = EZOLV], you cannot change the setting while the drive is running.</p>	Determined by A1-02 (0 - 60000 ms)	722
C4-03 (0217)	Torque Compensation @ FWD Start	<p>V/f CL-V/f OLV CLV AOLV OLV/PM AOLV/PM CLV/PM EZOLV</p> <p>Set the amount of torque reference for forward start as a percentage of the motor rated torque.</p>	0.0% (0.0 - 200.0%)	722
C4-04 (0218)	Torque Compensation @ REV Start	<p>V/f CL-V/f OLV CLV AOLV OLV/PM AOLV/PM CLV/PM EZOLV</p> <p>Sets the amount of torque reference for reverse start as a percentage of the motor rated torque.</p>	0.0% (-200.0 - 0.0%)	723
C4-05 (0219)	Torque Compensation Time	<p>V/f CL-V/f OLV CLV AOLV OLV/PM AOLV/PM CLV/PM EZOLV</p> <p>Sets the starting torque constant to use with C4-03 and C4-04 [Torque Compensation @ FWD/REV Start].</p>	10 ms (0 - 200 ms)	723
C4-06 (021A)	Motor 2 Torque Comp Delay Time	<p>V/f CL-V/f OLV CLV AOLV OLV/PM AOLV/PM CLV/PM EZOLV</p> <p>Sets the value if <i>ov</i> [Overvoltage] occurs with sudden changes in the load, at the end of acceleration, or at the start of deceleration.</p>	150 ms (0 - 10000 ms)	723
C4-07 (0341) RUN	Motor 2 Torque Compensation Gain	<p>V/f CL-V/f OLV CLV AOLV OLV/PM AOLV/PM CLV/PM EZOLV</p> <p>Sets the gain for motor 2 torque compensation function when using the Motor Switch function.</p>	1.00 (0.00 - 2.50)	723
C4-19 (0B8D) RUN Expert	Torque Ripple Suppress Min Freq	<p>V/f CL-V/f OLV CLV AOLV OLV/PM AOLV/PM CLV/PM EZOLV</p> <p>Adjust this if slow oscillation occurs at low speeds. Increase this parameter in 1.0 Hz increments when current ripples and torque ripples occur during low-speed operation. Set this parameter to 0.0 to disable the function if increasing the value does not fix the problem. Usually it is not necessary to change this setting.</p>	0.1 Hz (0.0 - 10.0 Hz)	723
C4-20 (0BCB) Expert	Voltage Compensation Adjust 1	<p>V/f CL-V/f OLV CLV AOLV OLV/PM AOLV/PM CLV/PM EZOLV</p> <p>Sets voltage precision compensation. Usually it is not necessary to change this setting.</p>	120 (0 - 200)	724
C4-21 (0BCC) RUN Expert	Voltage Compensation Adjust 2	<p>V/f CL-V/f OLV CLV AOLV OLV/PM AOLV/PM CLV/PM EZOLV</p> <p>Sets voltage precision compensation. Usually it is not necessary to change this setting.</p>	5 (0 - 10)	724
C4-23 (1583) RUN Expert	Current Control Gain	<p>V/f CL-V/f OLV CLV AOLV OLV/PM AOLV/PM CLV/PM EZOLV</p> <p>Current control gain. Usually it is not necessary to change this parameter.</p>	1.00 (0.50 - 2.50)	724

◆ C5: Auto Speed Regulator (ASR)

No. (Hex.)	Name	Description	Default (Range)	Ref.
C5-01 (021B) RUN	ASR Proportional Gain 1	<p><input type="checkbox"/> V/f <input checked="" type="checkbox"/> CL-V/f <input type="checkbox"/> OLV <input checked="" type="checkbox"/> CLV <input type="checkbox"/> AOLV <input type="checkbox"/> OLV/PM <input type="checkbox"/> AOLV/PM <input type="checkbox"/> CLV/PM <input type="checkbox"/> EZOLV</p> <p>Sets the gain to adjust ASR response.</p> <p>Note: If A1-02 = 0 [Control Method Selection = V/f], you must set H6-01 = 3 [Terminal RP Pulse Train Function = Speed Feedback (V/F Control)] to enable this parameter.</p>	Determined by A1-02 (0.00 - 300.00)	728
C5-02 (021C) RUN	ASR Integral Time 1	<p><input type="checkbox"/> V/f <input checked="" type="checkbox"/> CL-V/f <input type="checkbox"/> OLV <input checked="" type="checkbox"/> CLV <input type="checkbox"/> AOLV <input type="checkbox"/> OLV/PM <input type="checkbox"/> AOLV/PM <input type="checkbox"/> CLV/PM <input type="checkbox"/> EZOLV</p> <p>Sets the ASR integral time.</p> <p>Note: If A1-02 = 0 [Control Method Selection = V/f], you must set H6-01 = 3 [Terminal RP Pulse Train Function = Speed Feedback (V/F Control)] to enable this parameter.</p>	Determined by A1-02 (0.000 - 60.000 s)	728
C5-03 (021D) RUN	ASR Proportional Gain 2	<p><input type="checkbox"/> V/f <input checked="" type="checkbox"/> CL-V/f <input type="checkbox"/> OLV <input checked="" type="checkbox"/> CLV <input type="checkbox"/> AOLV <input type="checkbox"/> OLV/PM <input type="checkbox"/> AOLV/PM <input type="checkbox"/> CLV/PM <input type="checkbox"/> EZOLV</p> <p>Sets the gain to adjust ASR response.</p> <p>Note: If A1-02 = 0 [Control Method Selection = V/f], you must set H6-01 = 3 [Terminal RP Pulse Train Function = Speed Feedback (V/F Control)] to enable this parameter.</p>	Determined by A1-02 (0.00 - 300.00)	728
C5-04 (021E) RUN	ASR Integral Time 2	<p><input type="checkbox"/> V/f <input checked="" type="checkbox"/> CL-V/f <input type="checkbox"/> OLV <input checked="" type="checkbox"/> CLV <input type="checkbox"/> AOLV <input type="checkbox"/> OLV/PM <input type="checkbox"/> AOLV/PM <input type="checkbox"/> CLV/PM <input type="checkbox"/> EZOLV</p> <p>Sets the ASR integral time.</p> <p>Note: If A1-02 = 0 [Control Method Selection = V/f], you must set H6-01 = 3 [Terminal RP Pulse Train Function = Speed Feedback (V/F Control)] to enable this parameter.</p>	Determined by A1-02 (0.000 - 60.000 s)	728
C5-05 (021F)	ASR Limit	<p><input type="checkbox"/> V/f <input checked="" type="checkbox"/> CL-V/f <input type="checkbox"/> OLV <input type="checkbox"/> CLV <input type="checkbox"/> AOLV <input type="checkbox"/> OLV/PM <input type="checkbox"/> AOLV/PM <input type="checkbox"/> CLV/PM <input type="checkbox"/> EZOLV</p> <p>Set the ASR output limit as a percentage of E1-04 [Maximum Output Frequency].</p>	5.0% (0.0 - 20.0%)	729
C5-06 (0220)	ASR Delay Time	<p><input type="checkbox"/> V/f <input type="checkbox"/> CL-V/f <input type="checkbox"/> OLV <input checked="" type="checkbox"/> CLV <input type="checkbox"/> AOLV <input type="checkbox"/> OLV/PM <input type="checkbox"/> AOLV/PM <input type="checkbox"/> CLV/PM <input type="checkbox"/> EZOLV</p> <p>Sets the filter time constant of the torque reference output from the speed loop. Usually it is not necessary to change this setting.</p>	Determined by A1-02 (0.000 - 0.500 s)	729
C5-07 (0221)	ASR Gain Switchover Frequency	<p><input type="checkbox"/> V/f <input type="checkbox"/> CL-V/f <input type="checkbox"/> OLV <input checked="" type="checkbox"/> CLV <input type="checkbox"/> AOLV <input type="checkbox"/> OLV/PM <input type="checkbox"/> AOLV/PM <input type="checkbox"/> CLV/PM <input type="checkbox"/> EZOLV</p> <p>Sets the frequency where the drive will switch between these parameters: C5-01 and C5-03 [ASR Proportional Gain 1/2] C5-02 and C5-04 [ASR Integral Time 1/2]</p>	Determined by A1-02 (Determined by A1-02)	729
C5-08 (0222)	ASR Integral Limit	<p><input type="checkbox"/> V/f <input type="checkbox"/> CL-V/f <input type="checkbox"/> OLV <input checked="" type="checkbox"/> CLV <input type="checkbox"/> AOLV <input type="checkbox"/> OLV/PM <input type="checkbox"/> AOLV/PM <input type="checkbox"/> CLV/PM <input type="checkbox"/> EZOLV</p> <p>Set the upper limit of the ASR integral amount as a percentage of the rated load.</p>	400% (0 - 400%)	729
C5-12 (0386)	Integral Operation @ Accel/Decel	<p><input type="checkbox"/> V/f <input checked="" type="checkbox"/> CL-V/f <input type="checkbox"/> OLV <input type="checkbox"/> CLV <input type="checkbox"/> AOLV <input type="checkbox"/> OLV/PM <input type="checkbox"/> AOLV/PM <input type="checkbox"/> CLV/PM <input type="checkbox"/> EZOLV</p> <p>Sets ASR integral operation during acceleration and deceleration. 0 : Disabled 1 : Enabled</p> <p>Note: If A1-02 = 0 [Control Method Selection = V/f], you must set H6-01 = 3 [Terminal RP Pulse Train Function = Speed Feedback (V/F Control)] to enable this parameter.</p>	0 (0, 1)	729
C5-17 (0276) Expert	Motor Inertia	<p><input type="checkbox"/> V/f <input type="checkbox"/> CL-V/f <input type="checkbox"/> OLV <input checked="" type="checkbox"/> CLV <input type="checkbox"/> AOLV <input type="checkbox"/> OLV/PM <input type="checkbox"/> AOLV/PM <input type="checkbox"/> CLV/PM <input type="checkbox"/> EZOLV</p> <p>Sets the motor inertia.</p> <p>Note: The default settings and the display units for setting ranges are different for different drive models.</p> <ul style="list-style-type: none"> • 0.0001 kgm² units (setting range: 0.0001 kgm² to 6.0000 kgm²): 2004 to 2021, 4002 to 4012 • 0.001 kgm² units (setting range: 0.001 kgm² to 60.000 kgm²): 2030 to 2211, 4018 to 4103 • 0.01 kgm² units (setting range: 0.01 kgm² to 600.00 kgm²): 2257 to 2415, 4140 to 4720 	Determined by o2-04, C6-01, and E5-01 (0.0001 - 600.00 kgm ²)	730
C5-18 (0277) Expert	Load Inertia Ratio	<p><input type="checkbox"/> V/f <input type="checkbox"/> CL-V/f <input type="checkbox"/> OLV <input checked="" type="checkbox"/> CLV <input type="checkbox"/> AOLV <input type="checkbox"/> OLV/PM <input type="checkbox"/> AOLV/PM <input type="checkbox"/> CLV/PM <input type="checkbox"/> EZOLV</p> <p>Sets the load inertia ratio for the motor inertia.</p>	1.0 (0.0 - 6000.0)	730
C5-21 (0356) RUN	Motor 2 ASR Proportional Gain 1	<p><input type="checkbox"/> V/f <input checked="" type="checkbox"/> CL-V/f <input type="checkbox"/> OLV <input checked="" type="checkbox"/> CLV <input type="checkbox"/> AOLV <input type="checkbox"/> OLV/PM <input type="checkbox"/> AOLV/PM <input type="checkbox"/> CLV/PM <input type="checkbox"/> EZOLV</p> <p>Sets the gain to adjust ASR response for motor 2.</p>	Determined by E3-01 (0.00 - 300.00)	730
C5-22 (0357) RUN	Motor 2 ASR Integral Time 1	<p><input type="checkbox"/> V/f <input checked="" type="checkbox"/> CL-V/f <input type="checkbox"/> OLV <input checked="" type="checkbox"/> CLV <input type="checkbox"/> AOLV <input type="checkbox"/> OLV/PM <input type="checkbox"/> AOLV/PM <input type="checkbox"/> CLV/PM <input type="checkbox"/> EZOLV</p> <p>Sets the ASR integral time for motor 2.</p>	Determined by E3-01 (0.000 - 60.000 s)	730
C5-23 (0358) RUN	Motor 2 ASR Proportional Gain 2	<p><input type="checkbox"/> V/f <input checked="" type="checkbox"/> CL-V/f <input type="checkbox"/> OLV <input checked="" type="checkbox"/> CLV <input type="checkbox"/> AOLV <input type="checkbox"/> OLV/PM <input type="checkbox"/> AOLV/PM <input type="checkbox"/> CLV/PM <input type="checkbox"/> EZOLV</p> <p>Sets the gain to adjust ASR response for motor 2.</p>	Determined by E3-01 (0.00 - 300.00)	731

No. (Hex.)	Name	Description	Default (Range)	Ref.
C5-24 (0359) RUN	Motor 2 ASR Integral Time 2	<input type="checkbox"/> V/f <input checked="" type="checkbox"/> CL-V/f <input type="checkbox"/> OLV <input checked="" type="checkbox"/> CLV <input type="checkbox"/> AOLV <input type="checkbox"/> OLV/PM <input type="checkbox"/> AOLV/PM <input type="checkbox"/> CLV/PM <input type="checkbox"/> EZOLV Sets the ASR integral time for motor 2.	Determined by E3-01 (0.000 - 60.000 s)	731
C5-25 (035A)	Motor 2 ASR Limit	<input type="checkbox"/> V/f <input checked="" type="checkbox"/> CL-V/f <input type="checkbox"/> OLV <input type="checkbox"/> CLV <input type="checkbox"/> AOLV <input type="checkbox"/> OLV/PM <input type="checkbox"/> AOLV/PM <input type="checkbox"/> CLV/PM <input type="checkbox"/> EZOLV Set the motor 2 ASR output limit as a percentage of E1-04 [Maximum Output Frequency].	5.0% (0.0 - 20.0%)	731
C5-26 (035B)	Motor 2 ASR Delay Time	<input type="checkbox"/> V/f <input checked="" type="checkbox"/> CL-V/f <input type="checkbox"/> OLV <input checked="" type="checkbox"/> CLV <input type="checkbox"/> AOLV <input type="checkbox"/> OLV/PM <input type="checkbox"/> AOLV/PM <input type="checkbox"/> CLV/PM <input type="checkbox"/> EZOLV Sets the motor 2 filter time constant of the torque reference output from the speed loop. Usually it is not necessary to change this setting.	Determined by E3-01 (0.000 - 0.500 s)	731
C5-27 (035C)	Motor 2 ASR Gain Switchover Freq	<input type="checkbox"/> V/f <input checked="" type="checkbox"/> CL-V/f <input type="checkbox"/> OLV <input checked="" type="checkbox"/> CLV <input type="checkbox"/> AOLV <input type="checkbox"/> OLV/PM <input type="checkbox"/> AOLV/PM <input type="checkbox"/> CLV/PM <input type="checkbox"/> EZOLV Sets the frequency where the drive will switch between these parameters: C5-21 and C5-23 [Motor 2 ASR Proportional Gain 1/2] C5-22 and C5-24 [Motor 2 ASR Integral Time 1/2]	0.0 (0.0 - 400.0)	731
C5-28 (035D)	Motor 2 ASR Integral Limit	<input type="checkbox"/> V/f <input checked="" type="checkbox"/> CL-V/f <input type="checkbox"/> OLV <input checked="" type="checkbox"/> CLV <input type="checkbox"/> AOLV <input type="checkbox"/> OLV/PM <input type="checkbox"/> AOLV/PM <input type="checkbox"/> CLV/PM <input type="checkbox"/> EZOLV Set the upper limit of the motor 2 ASR integral amount as a percentage of the rated load.	400% (0 - 400%)	732
C5-29 (0B18) Expert	Speed Control Response	<input checked="" type="checkbox"/> V/f <input checked="" type="checkbox"/> CL-V/f <input type="checkbox"/> OLV <input checked="" type="checkbox"/> CLV <input type="checkbox"/> AOLV <input type="checkbox"/> OLV/PM <input type="checkbox"/> AOLV/PM <input type="checkbox"/> CLV/PM <input type="checkbox"/> EZOLV Sets the level of speed control responsiveness. Usually it is not necessary to change this setting. 0 : Standard 1 : High Performance 1	0 (0, 1)	732
C5-32 (0361)	Motor 2 Integral Oper at Acc/Dec	<input type="checkbox"/> V/f <input checked="" type="checkbox"/> CL-V/f <input type="checkbox"/> OLV <input type="checkbox"/> CLV <input type="checkbox"/> AOLV <input type="checkbox"/> OLV/PM <input type="checkbox"/> AOLV/PM <input type="checkbox"/> CLV/PM <input type="checkbox"/> EZOLV Sets ASR integral operation during acceleration and deceleration for motor 2. 0 : Disabled 1 : Enabled	0 (0, 1)	732
C5-37 (0278) Expert	Motor 2 Inertia	<input type="checkbox"/> V/f <input checked="" type="checkbox"/> CL-V/f <input type="checkbox"/> OLV <input checked="" type="checkbox"/> CLV <input type="checkbox"/> AOLV <input type="checkbox"/> OLV/PM <input type="checkbox"/> AOLV/PM <input type="checkbox"/> CLV/PM <input type="checkbox"/> EZOLV Sets the motor inertia for motor 2. Note: The default settings and the display units for setting ranges are different for different drive models. • 0.0001 kgm ² units (setting range: 0.0001 kgm ² to 6.0000 kgm ²): 2004 to 2021, 4002 to 4012 • 0.001 kgm ² units (setting range: 0.001 kgm ² to 60.0000 kgm ²): 2030 to 2211, 4018 to 4103 • 0.01 kgm ² units (setting range: 0.01 kgm ² to 600.00 kgm ²): 2257 to 2415, 4140 to 4720	Determined by o2-04, C6-01 (0.0001 - 600.00 kgm ²)	732
C5-38 (0279) Expert	Motor 2 Load Inertia Ratio	<input type="checkbox"/> V/f <input checked="" type="checkbox"/> CL-V/f <input type="checkbox"/> OLV <input checked="" type="checkbox"/> CLV <input type="checkbox"/> AOLV <input type="checkbox"/> OLV/PM <input type="checkbox"/> AOLV/PM <input type="checkbox"/> CLV/PM <input type="checkbox"/> EZOLV Sets the load inertia ratio for the motor 2 inertia.	1.0 (0.0 - 6000.0)	733
C5-39 (030D)	ASR Primary Delay Time Const 2	<input type="checkbox"/> V/f <input checked="" type="checkbox"/> CL-V/f <input type="checkbox"/> OLV <input type="checkbox"/> CLV <input type="checkbox"/> AOLV <input type="checkbox"/> OLV/PM <input type="checkbox"/> AOLV/PM <input checked="" type="checkbox"/> CLV/PM <input type="checkbox"/> EZOLV Sets the filter time constant used when the torque reference is output from ASR. Usually it is not necessary to change this parameter.	0.000 s (0.000 - 0.500 s)	733
C5-50 (0B14) Expert	Notch Filter Frequency	<input type="checkbox"/> V/f <input checked="" type="checkbox"/> CL-V/f <input type="checkbox"/> OLV <input checked="" type="checkbox"/> CLV <input type="checkbox"/> AOLV <input type="checkbox"/> OLV/PM <input type="checkbox"/> AOLV/PM <input type="checkbox"/> CLV/PM <input type="checkbox"/> EZOLV Sets the machine resonance frequency. Note: Set C5-50 = 0 [0 Hz] to disable the notch filter.	0 Hz (0, or 2 to 100 Hz)	733
C5-51 (0B15) Expert	Notch Filter Bandwidth	<input type="checkbox"/> V/f <input checked="" type="checkbox"/> CL-V/f <input type="checkbox"/> OLV <input checked="" type="checkbox"/> CLV <input type="checkbox"/> AOLV <input type="checkbox"/> OLV/PM <input type="checkbox"/> AOLV/PM <input type="checkbox"/> CLV/PM <input type="checkbox"/> EZOLV Sets the notch width of the notch filter. Note: Set C5-50 = 0 [Notch Filter Frequency = 0 Hz] to disable the notch filter.	1.0 (0.5 - 5.0)	733

◆ C6: Duty & Carrier Frequency

No. (Hex.)	Name	Description	Default (Range)	Ref.
C6-01 (0223)	Normal / Heavy Duty Selection	<p><input checked="" type="checkbox"/> V/f <input checked="" type="checkbox"/> CL-V/f <input checked="" type="checkbox"/> OLV <input checked="" type="checkbox"/> CLV <input checked="" type="checkbox"/> AOLV <input checked="" type="checkbox"/> OLV/PM <input checked="" type="checkbox"/> AOLV/PM <input checked="" type="checkbox"/> CLV/PM <input checked="" type="checkbox"/> EZOLV</p> <p>Sets the drive duty rating. 0 : Heavy Duty Rating 1 : Normal Duty Rating</p>	1 (0, 1)	733
C6-02 (0224)	Carrier Frequency Selection	<p><input checked="" type="checkbox"/> V/f <input checked="" type="checkbox"/> CL-V/f <input checked="" type="checkbox"/> OLV <input checked="" type="checkbox"/> CLV <input checked="" type="checkbox"/> AOLV <input checked="" type="checkbox"/> OLV/PM <input checked="" type="checkbox"/> AOLV/PM <input checked="" type="checkbox"/> CLV/PM <input checked="" type="checkbox"/> EZOLV</p> <p>Sets the carrier frequency for the transistors in the drive. 1 : 2.0 kHz 2 : 5.0 kHz (4.0 kHz AOLV/PM) 3 : 8.0 kHz (6.0 kHz AOLV/PM) 4 : 10.0 kHz (8.0 kHz AOLV/PM) 5 : 12.5 kHz (10.0 kHz AOLV/PM) 6 : 15.0 kHz (12.0 kHz AOLV/PM) 7 : Swing PWM1 (Audible Sound 1) 8 : Swing PWM2 (Audible Sound 2) 9 : Swing PWM3 (Audible Sound 3) A : Swing PWM4 (Audible Sound 4) F : User Defined (C6-03 to C6-05)</p> <p>Note: The carrier frequency for Swing PWM 1 to 4 is equivalent to 2.0 kHz.</p>	Determined by A1-02, C6-01, and o2-04 (Determined by A1-02)	734
C6-03 (0225)	Carrier Frequency Upper Limit	<p><input checked="" type="checkbox"/> V/f <input checked="" type="checkbox"/> CL-V/f <input checked="" type="checkbox"/> OLV <input checked="" type="checkbox"/> CLV <input checked="" type="checkbox"/> AOLV <input checked="" type="checkbox"/> OLV/PM <input checked="" type="checkbox"/> AOLV/PM <input checked="" type="checkbox"/> CLV/PM <input checked="" type="checkbox"/> EZOLV</p> <p>Sets the upper limit of the carrier frequency. Set $C6-02 = F$ [<i>Carrier Frequency Selection = User Defined (C6-03 to C6-05)</i>] to set this parameter.</p>	Determined by C6-02 (1.0 - 15.0 kHz)	735
C6-04 (0226)	Carrier Frequency Lower Limit	<p><input checked="" type="checkbox"/> V/f <input checked="" type="checkbox"/> CL-V/f <input checked="" type="checkbox"/> OLV <input checked="" type="checkbox"/> CLV <input checked="" type="checkbox"/> AOLV <input checked="" type="checkbox"/> OLV/PM <input checked="" type="checkbox"/> AOLV/PM <input checked="" type="checkbox"/> CLV/PM <input checked="" type="checkbox"/> EZOLV</p> <p>Sets the lower limit of the carrier frequency. Set $C6-02 = F$ [<i>Carrier Frequency Selection = User Defined (C6-03 to C6-05)</i>] to set this parameter.</p>	Determined by C6-02 (1.0 - 15.0 kHz)	736
C6-05 (0227)	Carrier Freq Proportional Gain	<p><input checked="" type="checkbox"/> V/f <input checked="" type="checkbox"/> CL-V/f <input checked="" type="checkbox"/> OLV <input checked="" type="checkbox"/> CLV <input checked="" type="checkbox"/> AOLV <input checked="" type="checkbox"/> OLV/PM <input checked="" type="checkbox"/> AOLV/PM <input checked="" type="checkbox"/> CLV/PM <input checked="" type="checkbox"/> EZOLV</p> <p>Sets the proportional gain for the carrier frequency. Set $C6-02 = F$ [<i>Carrier Frequency Selection = User Defined (C6-03 to C6-05)</i>] to set this parameter.</p>	Determined by C6-02 (0 - 99)	736
C6-09 (022B)	Carrier Freq at Rotational Tune	<p><input type="checkbox"/> V/f <input type="checkbox"/> CL-V/f <input type="checkbox"/> OLV <input type="checkbox"/> CLV <input type="checkbox"/> AOLV <input type="checkbox"/> OLV/PM <input type="checkbox"/> AOLV/PM <input type="checkbox"/> CLV/PM <input type="checkbox"/> EZOLV</p> <p>Sets the Auto-Tuning carrier frequency. Usually it is not necessary to change this setting. 0 : 5kHz 1 : use C6-03</p>	0 (0, 1)	736

11.7 d: Reference Settings

◆ d1: Frequency Reference

No. (Hex.)	Name	Description	Default (Range)	Ref.
d1-01 (0280) RUN	Reference 1	<p>V/f CL-V/f OLV CLV AOLV OLV/PM AOLV/PM CLV/PM EZOLV</p> <p>Sets the frequency reference in the units from <i>o1-03</i> [Frequency Display Unit Selection].</p> <p>Note: When <i>A1-02</i> = 6, 7 [Control Method Selection = AOLV/PM, CLV/PM], the drive changes <i>o1-03</i> = 1 [0.01% (100% = E1-04)].</p>	0.00 Hz (0.00 - 590.00 Hz)	740
d1-02 (0281) RUN	Reference 2	<p>V/f CL-V/f OLV CLV AOLV OLV/PM AOLV/PM CLV/PM EZOLV</p> <p>Sets the frequency reference in the units from <i>o1-03</i> [Frequency Display Unit Selection].</p> <p>Note: When <i>A1-02</i> = 6, 7 [Control Method Selection = AOLV/PM, CLV/PM], the drive changes <i>o1-03</i> = 1 [0.01% (100% = E1-04)].</p>	0.00 Hz (0.00 - 590.00 Hz)	741
d1-03 (0282) RUN	Reference 3	<p>V/f CL-V/f OLV CLV AOLV OLV/PM AOLV/PM CLV/PM EZOLV</p> <p>Sets the frequency reference in the units from <i>o1-03</i> [Frequency Display Unit Selection].</p> <p>Note: When <i>A1-02</i> = 6, 7 [Control Method Selection = AOLV/PM, CLV/PM], the drive changes <i>o1-03</i> = 1 [0.01% (100% = E1-04)].</p>	0.00 Hz (0.00 - 590.00 Hz)	741
d1-04 (0283) RUN	Reference 4	<p>V/f CL-V/f OLV CLV AOLV OLV/PM AOLV/PM CLV/PM EZOLV</p> <p>Sets the frequency reference in the units from <i>o1-03</i> [Frequency Display Unit Selection].</p> <p>Note: When <i>A1-02</i> = 6, 7 [Control Method Selection = AOLV/PM, CLV/PM], the drive changes <i>o1-03</i> = 1 [0.01% (100% = E1-04)].</p>	0.00 Hz (0.00 - 590.00 Hz)	741
d1-05 (0284) RUN	Reference 5	<p>V/f CL-V/f OLV CLV AOLV OLV/PM AOLV/PM CLV/PM EZOLV</p> <p>Sets the frequency reference in the units from <i>o1-03</i> [Frequency Display Unit Selection].</p> <p>Note: When <i>A1-02</i> = 6, 7 [Control Method Selection = AOLV/PM, CLV/PM], the drive changes <i>o1-03</i> = 1 [0.01% (100% = E1-04)].</p>	0.00 Hz (0.00 - 590.00 Hz)	741
d1-06 (0285) RUN	Reference 6	<p>V/f CL-V/f OLV CLV AOLV OLV/PM AOLV/PM CLV/PM EZOLV</p> <p>Sets the frequency reference in the units from <i>o1-03</i> [Frequency Display Unit Selection].</p> <p>Note: When <i>A1-02</i> = 6, 7 [Control Method Selection = AOLV/PM, CLV/PM], the drive changes <i>o1-03</i> = 1 [0.01% (100% = E1-04)].</p>	0.00 Hz (0.00 - 590.00 Hz)	741
d1-07 (0286) RUN	Reference 7	<p>V/f CL-V/f OLV CLV AOLV OLV/PM AOLV/PM CLV/PM EZOLV</p> <p>Sets the frequency reference in the units from <i>o1-03</i> [Frequency Display Unit Selection].</p> <p>Note: When <i>A1-02</i> = 6, 7 [Control Method Selection = AOLV/PM, CLV/PM], the drive changes <i>o1-03</i> = 1 [0.01% (100% = E1-04)].</p>	0.00 Hz (0.00 - 590.00 Hz)	742
d1-08 (0287) RUN	Reference 8	<p>V/f CL-V/f OLV CLV AOLV OLV/PM AOLV/PM CLV/PM EZOLV</p> <p>Sets the frequency reference in the units from <i>o1-03</i> [Frequency Display Unit Selection].</p> <p>Note: When <i>A1-02</i> = 6, 7 [Control Method Selection = AOLV/PM, CLV/PM], the drive changes <i>o1-03</i> = 1 [0.01% (100% = E1-04)].</p>	0.00 Hz (0.00 - 590.00 Hz)	742
d1-09 (0288) RUN	Reference 9	<p>V/f CL-V/f OLV CLV AOLV OLV/PM AOLV/PM CLV/PM EZOLV</p> <p>Sets the frequency reference in the units from <i>o1-03</i> [Frequency Display Unit Selection].</p> <p>Note: When <i>A1-02</i> = 6, 7 [Control Method Selection = AOLV/PM, CLV/PM], the drive changes <i>o1-03</i> = 1 [0.01% (100% = E1-04)].</p>	0.00 Hz (0.00 - 590.00 Hz)	742
d1-10 (028B) RUN	Reference 10	<p>V/f CL-V/f OLV CLV AOLV OLV/PM AOLV/PM CLV/PM EZOLV</p> <p>Sets the frequency reference in the units from <i>o1-03</i> [Frequency Display Unit Selection].</p> <p>Note: When <i>A1-02</i> = 6, 7 [Control Method Selection = AOLV/PM, CLV/PM], the drive changes <i>o1-03</i> = 1 [0.01% (100% = E1-04)].</p>	0.00 Hz (0.00 - 590.00 Hz)	742
d1-11 (028C) RUN	Reference 11	<p>V/f CL-V/f OLV CLV AOLV OLV/PM AOLV/PM CLV/PM EZOLV</p> <p>Sets the frequency reference in the units from <i>o1-03</i> [Frequency Display Unit Selection].</p> <p>Note: When <i>A1-02</i> = 6, 7 [Control Method Selection = AOLV/PM, CLV/PM], the drive changes <i>o1-03</i> = 1 [0.01% (100% = E1-04)].</p>	0.00 Hz (0.00 - 590.00 Hz)	743

11.7 d: Reference Settings

No. (Hex.)	Name	Description	Default (Range)	Ref.
d1-12 (028D) RUN	Reference 12	<p>V/f CL-V/f OLV CLV AOLV OLV/PM AOLV/PM CLV/PM EZOLV</p> <p>Sets the frequency reference in the units from o1-03 [Frequency Display Unit Selection].</p> <p>Note: When A1-02 = 6, 7 [Control Method Selection = AOLV/PM, CLV/PM], the drive changes o1-03 = 1 [0.01% (100% = E1-04)].</p>	0.00 Hz (0.00 - 590.00 Hz)	743
d1-13 (028E) RUN	Reference 13	<p>V/f CL-V/f OLV CLV AOLV OLV/PM AOLV/PM CLV/PM EZOLV</p> <p>Sets the frequency reference in the units from o1-03 [Frequency Display Unit Selection].</p> <p>Note: When A1-02 = 6, 7 [Control Method Selection = AOLV/PM, CLV/PM], the drive changes o1-03 = 1 [0.01% (100% = E1-04)].</p>	0.00 Hz (0.00 - 590.00 Hz)	743
d1-14 (028F) RUN	Reference 14	<p>V/f CL-V/f OLV CLV AOLV OLV/PM AOLV/PM CLV/PM EZOLV</p> <p>Sets the frequency reference in the units from o1-03 [Frequency Display Unit Selection].</p> <p>Note: When A1-02 = 6, 7 [Control Method Selection = AOLV/PM, CLV/PM], the drive changes o1-03 = 1 [0.01% (100% = E1-04)].</p>	0.00 Hz (0.00 - 590.00 Hz)	743
d1-15 (0290) RUN	Reference 15	<p>V/f CL-V/f OLV CLV AOLV OLV/PM AOLV/PM CLV/PM EZOLV</p> <p>Sets the frequency reference in the units from o1-03 [Frequency Display Unit Selection].</p> <p>Note: When A1-02 = 6, 7 [Control Method Selection = AOLV/PM, CLV/PM], the drive changes o1-03 = 1 [0.01% (100% = E1-04)].</p>	0.00 Hz (0.00 - 590.00 Hz)	743
d1-16 (0291) RUN	Reference 16	<p>V/f CL-V/f OLV CLV AOLV OLV/PM AOLV/PM CLV/PM EZOLV</p> <p>Sets the frequency reference in the units from o1-03 [Frequency Display Unit Selection].</p> <p>Note: When A1-02 = 6, 7 [Control Method Selection = AOLV/PM, CLV/PM], the drive changes o1-03 = 1 [0.01% (100% = E1-04)].</p>	0.00 Hz (0.00 - 590.00 Hz)	744
d1-17 (0292) RUN	Jog Reference	<p>V/f CL-V/f OLV CLV AOLV OLV/PM AOLV/PM CLV/PM EZOLV</p> <p>Sets the Jog frequency reference in the units from o1-03 [Frequency Display Unit Selection]. Set H1-xx = 6 [MFD1 Function Select = Jog Reference Selection] to use the Jog frequency reference.</p> <p>Note: When A1-02 = 6, 7 [Control Method Selection = AOLV/PM, CLV/PM], the drive sets o1-03 = 1 [0.01% (100% = E1-04)].</p>	6.00 Hz (0.00 - 590.00 Hz)	744

◆ d2: Reference Limits

No. (Hex.)	Name	Description	Default (Range)	Ref.
d2-01 (0289)	Frequency Reference Upper Limit	<p>V/f CL-V/f OLV CLV AOLV OLV/PM AOLV/PM CLV/PM EZOLV</p> <p>Sets maximum limit for all frequency references. The maximum output frequency is 100%.</p> <p>Note: Parameter A1-02 [Control Method Selection] selects which parameter is the maximum output frequency. • A1-02 ≠ 8 [EZOLV]: E1-04 [Maximum Output Frequency] • A1-02 = 8: E9-02 [Motor Max Revolutions]</p>	100.0% (0.0 - 110.0%)	744
d2-02 (028A)	Frequency Reference Lower Limit	<p>V/f CL-V/f OLV CLV AOLV OLV/PM AOLV/PM CLV/PM EZOLV</p> <p>Sets minimum limit for all frequency references. The maximum output frequency is 100%.</p> <p>Note: Parameter A1-02 [Control Method Selection] selects which parameter is the maximum output frequency. • A1-02 ≠ 8 [EZOLV]: E1-04 [Maximum Output Frequency] • A1-02 = 8: E9-02 [Motor Max Revolutions]</p>	0.0% (0.0 - 110.0%)	745
d2-03 (0293)	Analog Frequency Ref Lower Limit	<p>V/f CL-V/f OLV CLV AOLV OLV/PM AOLV/PM CLV/PM EZOLV</p> <p>Sets the lower limit for the master frequency reference (the first frequency of the multi-step speed reference) as a percentage. The maximum output frequency is 100%.</p> <p>Note: Parameter A1-02 [Control Method Selection] selects which parameter is the maximum output frequency. • A1-02 ≠ 8: E1-04 [Maximum Output Frequency] • A1-02 = 8: E9-02 [Maximum Speed]</p>	0.0% (0.0 - 110.0%)	745

◆ d3: Jump Frequency

No. (Hex.)	Name	Description	Default (Range)	Ref.
d3-01 (0294)	Jump Frequency 1	V/f CL-V/f OLV CLV AOLV OLV/PM AOLV/PM CLV/PM EZOLV Sets the median value of the frequency band that the drive will avoid.	0.0 Hz (Determined by A1-02)	746
d3-02 (0295)	Jump Frequency 2	V/f CL-V/f OLV CLV AOLV OLV/PM AOLV/PM CLV/PM EZOLV Sets the median value of the frequency band that the drive will avoid.	0.0 Hz (Determined by A1-02)	746
d3-03 (0296)	Jump Frequency 3	V/f CL-V/f OLV CLV AOLV OLV/PM AOLV/PM CLV/PM EZOLV Sets the median value of the frequency band that the drive will avoid.	0.0 Hz (Determined by A1-02)	746
d3-04 (0297)	Jump Frequency Width	V/f CL-V/f OLV CLV AOLV OLV/PM AOLV/PM CLV/PM EZOLV Sets the width of the frequency band that the drive will avoid.	1.0 Hz (Determined by A1-02)	746

◆ d4: Frequency Ref Up/Down & Hold

No. (Hex.)	Name	Description	Default (Range)	Ref.
d4-01 (0298)	Freq Reference Hold Selection	V/f CL-V/f OLV CLV AOLV OLV/PM AOLV/PM CLV/PM EZOLV Sets the function that saves the frequency reference or the frequency bias (Up/Down 2) after a Stop command or when de-energizing the drive. Set <i>H1-xx</i> [<i>MFDI Function Selection</i>] to one of these values to enable this parameter: <ul style="list-style-type: none"> <i>A</i> [<i>Accel/Decel Ramp Hold</i>] <i>10/11</i> [<i>Up/Down Command</i>] <i>75/76</i> [<i>Up/Down 2 Command</i>] 0 : Disabled 1 : Enabled	0 (0, 1)	746
d4-03 (02AA) RUN	Up/Down 2 Bias Step Frequency	V/f CL-V/f OLV CLV AOLV OLV/PM AOLV/PM CLV/PM EZOLV Sets the bias that the Up/Down 2 function adds to or subtracts from the frequency reference.	0.00 Hz (0.00 - 99.99 Hz)	748
d4-04 (02AB) RUN	Up/Down 2 Ramp Selection	V/f CL-V/f OLV CLV AOLV OLV/PM AOLV/PM CLV/PM EZOLV Sets the acceleration and deceleration times for the Up/Down 2 function to apply the bias to the frequency reference. 0 : Use Selected Accel/Decel Time 1 : Use Accel/Decel Time 4	0 (0, 1)	749
d4-05 (02AC) RUN	Up/Down 2 Bias Mode Selection	V/f CL-V/f OLV CLV AOLV OLV/PM AOLV/PM CLV/PM EZOLV Sets the function that saves the bias value to the drive when you open or close the two <i>Up/Down 2 Commands</i> [<i>H1-xx = 75, 76</i>]. Set <i>d4-03</i> [<i>Up/Down 2 Bias Step Frequency</i>] = 0.00 before you set this parameter. 0 : Hold when Neither Up/Down Closed 1 : Reset when Neither / Both Closed	0 (0, 1)	749
d4-06 (02AD)	Frequency Ref Bias (Up/Down 2)	V/f CL-V/f OLV CLV AOLV OLV/PM AOLV/PM CLV/PM EZOLV Saves the bias value from the Up/Down 2 Command where the Maximum Output Frequency is 100%. Note: Parameter <i>A1-02</i> [<i>Control Method Selection</i>] selects which parameter is the maximum output frequency. <ul style="list-style-type: none"> <i>A1-02</i> ≠ 8 [<i>EZOLV</i>]: <i>E1-04</i> [<i>Maximum Output Frequency</i>] <i>A1-02</i> = 8: <i>E9-02</i> [<i>Maximum Speed</i>] 	0.0% (-99.9 - +100.0%)	750
d4-07 (02AE) RUN	Analog Freq Ref Fluctuate Limit	V/f CL-V/f OLV CLV AOLV OLV/PM AOLV/PM CLV/PM EZOLV If the frequency reference changes for more than the level set to this parameter, then the bias value will be held. The value is set as a percentage of the Maximum Output Frequency. Note: Parameter <i>A1-02</i> [<i>Control Method Selection</i>] selects which parameter is the maximum output frequency. <ul style="list-style-type: none"> <i>A1-02</i> ≠ 8 [<i>EZOLV</i>]: <i>E1-04</i> [<i>Maximum Output Frequency</i>] <i>A1-02</i> = 8: <i>E9-02</i> [<i>Maximum Speed</i>] 	1.0% (0.1 - 100.0%)	750
d4-08 (02AF) RUN	Up/Down 2 Bias Upper Limit	V/f CL-V/f OLV CLV AOLV OLV/PM AOLV/PM CLV/PM EZOLV Sets the upper limit of the Up/Down 2 bias as a percentage of the Maximum Output Frequency. Note: Parameter <i>A1-02</i> [<i>Control Method Selection</i>] selects which parameter is the maximum output frequency. <ul style="list-style-type: none"> <i>A1-02</i> ≠ 8 [<i>EZOLV</i>]: <i>E1-04</i> [<i>Maximum Output Frequency</i>] <i>A1-02</i> = 8: <i>E9-02</i> [<i>Maximum Speed</i>] 	100.0% (0.0 - 100.0%)	750

11.7 d: Reference Settings

No. (Hex.)	Name	Description	Default (Range)	Ref.
d4-09 (02B0) RUN	Up/Down 2 Bias Lower Limit	<p>V/f CL-V/f OLV CLV AOLV OLV/PM AOLV/PM CLV/PM EZOLV</p> <p>Sets the lower limit of the Up/Down 2 bias as a percentage of the Maximum Output Frequency.</p> <p>Note: Parameter <i>A1-02</i> [Control Method Selection] selects which parameter is the maximum output frequency. • <i>A1-02</i> ≠ 8 [EZOLV]: <i>E1-04</i> [Maximum Output Frequency] • <i>A1-02</i> = 8: <i>E9-02</i> [Maximum Speed]</p>	0.0% (-99.9 - 0.0%)	751
d4-10 (02B6)	Up/Down Freq Lower Limit Select	<p>V/f CL-V/f OLV CLV AOLV OLV/PM AOLV/PM CLV/PM EZOLV</p> <p>Sets the lower frequency limit for the Up/Down function. 0 : Greater of d2-02 or Analog 1 : d2-02</p>	0 (0, 1)	751

◆ d5: Torque Control

No. (Hex.)	Name	Description	Default (Range)	Ref.
d5-01 (029A)	Torque Control Selection	<p>V/f CL-V/f OLV CLV AOLV OLV/PM AOLV/PM CLV/PM EZOLV</p> <p>Sets the drive for torque control or speed control. 0 : Speed Control 1 : Torque Control</p>	0 (0, 1)	755
d5-02 (029B)	Torque Reference Delay Time	<p>V/f CL-V/f OLV CLV AOLV OLV/PM AOLV/PM CLV/PM EZOLV</p> <p>Sets the primary delay time constant for the torque reference filter.</p>	Determined by A1-02 (0 - 1000 ms)	755
d5-03 (029C)	Speed Limit Selection	<p>V/f CL-V/f OLV CLV AOLV OLV/PM AOLV/PM CLV/PM EZOLV</p> <p>Sets the torque control speed limit method. 1 : Active Frequency Reference 2 : d5-04 Setting</p>	1 (1, 2)	755
d5-04 (029D)	Speed Limit	<p>V/f CL-V/f OLV CLV AOLV OLV/PM AOLV/PM CLV/PM EZOLV</p> <p>Sets the speed limit during Torque Control as a percentage of <i>E1-04</i> [Maximum Output Frequency]. Set <i>d5-03</i> = 2 [Speed Limit Selection = d5-04 Setting] before you set this parameter.</p>	0% (-120 - +120%)	756
d5-05 (029E)	Speed Limit Bias	<p>V/f CL-V/f OLV CLV AOLV OLV/PM AOLV/PM CLV/PM EZOLV</p> <p>Sets the speed limit bias value as a percentage of <i>E1-04</i> [Maximum Output Frequency].</p>	10% (0 - 120%)	756
d5-06 (029F)	Speed/Torque Changeover Time	<p>V/f CL-V/f OLV CLV AOLV OLV/PM AOLV/PM CLV/PM EZOLV</p> <p>Sets the delay time to switch between Speed Control and Torque Control. Set <i>H1-xx</i> = 71 [MFDI Function Selection = Torque Control] before you set this parameter.</p>	0 ms (0 - 1000 ms)	756
d5-08 (02B5)	Uni-directional Speed Limit Bias	<p>V/f CL-V/f OLV CLV AOLV OLV/PM AOLV/PM CLV/PM EZOLV</p> <p>Sets the direction of the speed limit reference to which Speed Limit Bias [d5-05] applies. 0 : Disabled 1 : Enabled</p>	1 (0, 1)	756

◆ d6: Field Weakening /Forcing

No. (Hex.)	Name	Description	Default (Range)	Ref.
d6-01 (02A0)	Field Weakening Level	<p>V/f CL-V/f OLV CLV AOLV OLV/PM AOLV/PM CLV/PM EZOLV</p> <p>Sets the drive output voltage as a percentage of <i>E1-05</i> [Maximum Output Voltage] when <i>H1-xx</i> = 63 [Field Weakening] is activated.</p>	80% (0 - 100%)	757
d6-02 (02A1)	Field Weakening Frequency Limit	<p>V/f CL-V/f OLV CLV AOLV OLV/PM AOLV/PM CLV/PM EZOLV</p> <p>Sets the minimum output frequency to start field weakening.</p>	0.0 Hz (0.0 - 590.0 Hz)	757
d6-03 (02A2)	Field Forcing Selection	<p>V/f CL-V/f OLV CLV AOLV OLV/PM AOLV/PM CLV/PM EZOLV</p> <p>Sets the field forcing function. 0 : Disabled 1 : Enabled</p>	0 (0, 1)	757
d6-06 (02A5)	Field Forcing Limit	<p>V/f CL-V/f OLV CLV AOLV OLV/PM AOLV/PM CLV/PM EZOLV</p> <p>Sets the limit value for field forcing to increase the motor excitation current reference as a percentage of <i>E2-03</i> [Motor No-Load Current]. Usually it is not necessary to change this setting.</p>	400% (100 - 400%)	757

◆ d7: Offset Frequency

No. (Hex.)	Name	Description	Default (Range)	Ref.
d7-01 (02B2) RUN	Offset Frequency 1	<p>V/f CL-V/f OLV CLV AOLV OLV/PM AOLV/PM CLV/PM EZOLV</p> <p>Uses $H1-xx = 44$ [MFDI Function Select = Add Offset Frequency 1 (d7-01)] as a percentage of the Maximum Output Frequency to add or subtract the set frequency to/from the frequency reference.</p> <p>Note: Parameter $A1-02$ [Control Method Selection] selects which parameter is the maximum output frequency. <ul style="list-style-type: none"> $A1-02 \neq 8$ [EZOLV]: $E1-04$ [Maximum Output Frequency] $A1-02 = 8$: $E9-02$ [Maximum Speed] </p>	0.0% (-100.0 - +100.0%)	758
d7-02 (02B3) RUN	Offset Frequency 2	<p>V/f CL-V/f OLV CLV AOLV OLV/PM AOLV/PM CLV/PM EZOLV</p> <p>Uses $H1-xx = 45$ [MFDI Function Select = Add Offset Frequency 2 (d7-02)] as a percentage of the Maximum Output Frequency to add or subtract the set frequency to/from the frequency reference.</p> <p>Note: Parameter $A1-02$ [Control Method Selection] selects which parameter is the maximum output frequency. <ul style="list-style-type: none"> $A1-02 \neq 8$ [EZOLV]: $E1-04$ [Maximum Output Frequency] $A1-02 = 8$: $E9-02$ [Maximum Speed] </p>	0.0% (-100.0 - +100.0%)	758
d7-03 (02B4) RUN	Offset Frequency 3	<p>V/f CL-V/f OLV CLV AOLV OLV/PM AOLV/PM CLV/PM EZOLV</p> <p>Uses $H1-xx = 46$ [MFDI Function Select = Add Offset Frequency 3 (d7-03)] as a percentage of the Maximum Output Frequency to add or subtract the set frequency to/from the frequency reference.</p> <p>Note: Parameter $A1-02$ [Control Method Selection] selects which parameter is the maximum output frequency. <ul style="list-style-type: none"> $A1-02 \neq 8$ [EZOLV]: $E1-04$ [Maximum Output Frequency] $A1-02 = 8$: $E9-02$ [Maximum Speed] </p>	0.0% (-100.0 - +100.0%)	758

11.8 E: Motor Parameters

◆ E1: V/f Pattern for Motor 1

No. (Hex.)	Name	Description	Default (Range)	Ref.
E1-01 (0300)	Input AC Supply Voltage	<p>V/f CL-V/f OLV CLV AOLV OLV/PM AOLV/PM CLV/PM EZOLV</p> <p>Sets the drive input voltage.</p> <p>NOTICE: Set parameter E1-01 to align with the drive input voltage (not motor voltage). If this parameter is incorrect, the protective functions of the drive will not operate correctly and it can cause damage to the drive.</p>	200 V Class: 240 V, 400 V: 480 V (200 V Class: 155 to 255 V, 400 V Class: 310 to 510 V)	760
E1-03 (0302)	V/f Pattern Selection	<p>V/f CL-V/f OLV CLV AOLV OLV/PM AOLV/PM CLV/PM EZOLV</p> <p>Sets the V/f pattern for the drive and motor. You can use one of the preset patterns or you can make a custom pattern.</p> <p>0 : Const Trq, 50Hz base, 50Hz max 1 : Const Trq, 60Hz base, 60Hz max 2 : Const Trq, 50Hz base, 60Hz max 3 : Const Trq, 60Hz base, 72Hz max 4 : VT, 50Hz, 65% Vmid reduction 5 : VT, 50Hz, 50% Vmid reduction 6 : VT, 60 Hz, 65% Vmid reduction 7 : VT, 60Hz, 50% Vmid reduction 8 : High Trq, 50Hz, 25% Vmin boost 9 : High Trq, 50Hz, 65% Vmin boost A : High Trq, 60Hz, 25% Vmin boost B : High Trq, 60Hz, 65% Vmin boost C : High Freq, 60Hz base, 90Hz max D : High Freq, 60Hz base, 120Hz max E : High Freq, 60Hz base, 180Hz max F : Custom</p> <p>Note:</p> <ul style="list-style-type: none"> When A1-02 = 2 [Control Method Selection = OLV], settings 0 to E are not available. Set the correct V/f pattern for the application and operation area. An incorrect V/f pattern can decrease motor torque and increase current from overexcitation. 	F (Determined by A1-02)	760
E1-04 (0303)	Maximum Output Frequency	<p>V/f CL-V/f OLV CLV AOLV OLV/PM AOLV/PM CLV/PM EZOLV</p> <p>Sets the maximum output frequency for the V/f pattern.</p>	Determined by A1-02 and E5-01 (Determined by A1-02 and E5-01)	765
E1-05 (0304)	Maximum Output Voltage	<p>V/f CL-V/f OLV CLV AOLV OLV/PM AOLV/PM CLV/PM EZOLV</p> <p>Sets the maximum output voltage for the V/f pattern.</p>	200 V Class: 230.0 V, 400 V: 460.0 V (200 V Class: 0.0 - 255.0 V, 400 V Class: 0.0 - 510.0 V)	766
E1-06 (0305)	Base Frequency	<p>V/f CL-V/f OLV CLV AOLV OLV/PM AOLV/PM CLV/PM EZOLV</p> <p>Sets the base frequency for the V/f pattern.</p>	Determined by A1-02 and E5-01 (0.0 - E1-04)	766
E1-07 (0306)	Mid Point A Frequency	<p>V/f CL-V/f OLV CLV AOLV OLV/PM AOLV/PM CLV/PM EZOLV</p> <p>Sets a middle output frequency for the V/f pattern.</p>	Determined by A1-02 (0.0 - E1-04)	766
E1-08 (0307)	Mid Point A Voltage	<p>V/f CL-V/f OLV CLV AOLV OLV/PM AOLV/PM CLV/PM EZOLV</p> <p>Sets a middle output voltage for the V/f pattern.</p>	Determined by A1-02, C6-01 and o2-04 (200 V Class: 0.0 - 255.0 V _s , 400 V Class: 0.0 - 510.0 V)	766
E1-09 (0308)	Minimum Output Frequency	<p>V/f CL-V/f OLV CLV AOLV OLV/PM AOLV/PM CLV/PM EZOLV</p> <p>Sets the minimum output frequency for the V/f pattern.</p>	Determined by A1-02 and E5-01 (Determined by A1-02, E1-04, and E5-01)	766
E1-10 (0309)	Minimum Output Voltage	<p>V/f CL-V/f OLV CLV AOLV OLV/PM AOLV/PM CLV/PM EZOLV</p> <p>Sets the minimum output voltage for the V/f pattern.</p>	Determined by A1-02 (200 V Class: 0.0 to 255.0 V, 400 V Class: 0.0 to 510.0 V)	766
E1-11 (030A) Expert	Mid Point B Frequency	<p>V/f CL-V/f OLV CLV AOLV OLV/PM AOLV/PM CLV/PM EZOLV</p> <p>Sets a middle output frequency for the V/f pattern.</p>	0.0 Hz (0.0 - E1-04)	766

No. (Hex.)	Name	Description	Default (Range)	Ref.
E1-12 (030B) Expert	Mid Point B Voltage	V/f CL-V/f OLV CLV AOLV OLV/PM AOLV/PM CLV/PM EZOLV Sets a middle point voltage for the V/f pattern.	0.0 V (200 V Class: 0.0 to 255.0 V, 400 V Class: 0.0 to 510.0 V)	767
E1-13 (030C) Expert	Base Voltage	V/f CL-V/f OLV CLV AOLV OLV/PM AOLV/PM CLV/PM EZOLV Sets the base voltage for the V/f pattern.	0.0 V (200 V Class: 0.0 - 255.0 V, 400 V Class: 0.0 - 510.0 V)	767

◆ E2: Motor Parameters

No. (Hex.)	Name	Description	Default (Range)	Ref.
E2-01 (030E)	Motor Rated Current (FLA)	V/f CL-V/f OLV CLV AOLV OLV/PM AOLV/PM CLV/PM EZOLV Sets the motor rated current in amps.	Determined by o2-04, C6-01 (10% to 200% of the drive rated current)	767
E2-02 (030F)	Motor Rated Slip	V/f CL-V/f OLV CLV AOLV OLV/PM AOLV/PM CLV/PM EZOLV Sets motor rated slip.	Determined by o2-04, C6-01 (0.000 - 20.000 Hz)	767
E2-03 (0310)	Motor No-Load Current	V/f CL-V/f OLV CLV AOLV OLV/PM AOLV/PM CLV/PM EZOLV Sets the no-load current for the motor in amps when operating at the rated frequency and the no-load voltage.	Determined by o2-04, C6-01 (0 to E2-01)	768
E2-04 (0311)	Motor Pole Count	V/f CL-V/f OLV CLV AOLV OLV/PM AOLV/PM CLV/PM EZOLV Sets the number of motor poles. Note: • When A1-02 = 0, 1, 3 [Control Method Selection = V/f, CL-V/f, CLV], the maximum value is 120. • When A1-02 = 2, 4 [OLV, AOLV], the maximum value is 48.	4 (2 - 120)	768
E2-05 (0312)	Motor Line-to-Line Resistance	V/f CL-V/f OLV CLV AOLV OLV/PM AOLV/PM CLV/PM EZOLV Sets the line-to-line resistance for the motor stator windings.	Determined by o2-04, C6-01 (0.000 - 65.000 Ω)	768
E2-06 (0313)	Motor Leakage Inductance	V/f CL-V/f OLV CLV AOLV OLV/PM AOLV/PM CLV/PM EZOLV Sets the voltage drop from motor leakage inductance when the motor is operating at the rated frequency and rated current. This value is a percentage of Motor Rated Voltage.	Determined by o2-04, C6-01 (0.0 - 60.0%)	769
E2-07 (0314)	Motor Saturation Coefficient 1	V/f CL-V/f OLV CLV AOLV OLV/PM AOLV/PM CLV/PM EZOLV Sets the motor iron-core saturation coefficient at 50% of the magnetic flux.	0.50 (0.00 - 0.50)	769
E2-08 (0315)	Motor Saturation Coefficient 2	V/f CL-V/f OLV CLV AOLV OLV/PM AOLV/PM CLV/PM EZOLV Sets the motor iron-core saturation coefficient at 75% of the magnetic flux.	0.75 (E2-07 - 0.75)	769
E2-09 (0316) Expert	Motor Mechanical Loss	V/f CL-V/f OLV CLV AOLV OLV/PM AOLV/PM CLV/PM EZOLV Sets the mechanical loss of the motor. It is set as a percentage of E2-11 [Motor Rated Power]. Usually it is not necessary to change this setting.	0.0% (0.0 - 10.0%)	769
E2-10 (0317)	Motor Iron Loss	V/f CL-V/f OLV CLV AOLV OLV/PM AOLV/PM CLV/PM EZOLV Sets the motor iron loss.	Determined by o2-04, C6-01 (0 - 65535 W)	769
E2-11 (0318)	Motor Rated Power	V/f CL-V/f OLV CLV AOLV OLV/PM AOLV/PM CLV/PM EZOLV Sets the motor rated output in the units from o1-58 [Motor Power Unit Selection].	Determined by o2-04, C6-01 (0.00 - 650.00 HP)	769

◆ E3: V/f Pattern for Motor 2

No. (Hex.)	Name	Description	Default (Range)	Ref.
E3-01 (0319)	Motor 2 Control Mode Selection	<p>V/f CL-V/f OLV CLV AOLV OLV/PM AOLV/PM CLV/PM EZOLV</p> <p>Sets the control method for motor 2.</p> <p>Note: When you change this setting, the drive will set all parameters that are dependent on this parameter to their default settings.</p> <p>0 : V/f Control 1 : V/f Control with Encoder 2 : Open Loop Vector 3 : Closed Loop Vector</p>	0 (0 - 3)	770
E3-04 (031A)	Motor 2 Maximum Output Frequency	<p>V/f CL-V/f OLV CLV AOLV OLV/PM AOLV/PM CLV/PM EZOLV</p> <p>Set the maximum output frequency for the motor 2 V/f pattern.</p>	Determined by E3-01 (40.0 - 590.0 Hz)	770
E3-05 (031B)	Motor 2 Maximum Output Voltage	<p>V/f CL-V/f OLV CLV AOLV OLV/PM AOLV/PM CLV/PM EZOLV</p> <p>Sets the maximum output voltage for the motor 2 V/f pattern.</p>	Determined by E3-01 (200 V Class: 0.0 - 255.0 V, 400 V Class: 0.0 - 510.0 V)	771
E3-06 (031C)	Motor 2 Base Frequency	<p>V/f CL-V/f OLV CLV AOLV OLV/PM AOLV/PM CLV/PM EZOLV</p> <p>Sets the base frequency for the motor 2 V/f pattern.</p>	Determined by E3-01 (0.0 - E3-04)	771
E3-07 (031D)	Motor 2 Mid Point A Frequency	<p>V/f CL-V/f OLV CLV AOLV OLV/PM AOLV/PM CLV/PM EZOLV</p> <p>Sets a middle output frequency for the motor 2 V/f pattern.</p>	Determined by E3-01 (0.0 - E3-04)	771
E3-08 (031E)	Motor 2 Mid Point A Voltage	<p>V/f CL-V/f OLV CLV AOLV OLV/PM AOLV/PM CLV/PM EZOLV</p> <p>Sets a middle output voltage for the motor 2 V/f pattern.</p>	Determined by E3-01 (200 V Class: 0.0 - 255.0 V, 400 V Class: 0.0 - 510.0 V)	771
E3-09 (031F)	Motor 2 Minimum Output Frequency	<p>V/f CL-V/f OLV CLV AOLV OLV/PM AOLV/PM CLV/PM EZOLV</p> <p>Sets the minimum output frequency for the motor 2 V/f pattern.</p>	Determined by E3-01 (0.0 - E3-04)	771
E3-10 (0320)	Motor 2 Minimum Output Voltage	<p>V/f CL-V/f OLV CLV AOLV OLV/PM AOLV/PM CLV/PM EZOLV</p> <p>Sets the minimum output voltage for the motor 2 V/f pattern.</p>	Determined by E3-01 (200 V Class: 0.0 - 255.0 V, 400 V Class: 0.0 - 510.0 V)	771
E3-11 (0345) Expert	Motor 2 Mid Point B Frequency	<p>V/f CL-V/f OLV CLV AOLV OLV/PM AOLV/PM CLV/PM EZOLV</p> <p>Sets a middle output frequency for the motor 2 V/f pattern. Set this parameter to adjust the V/f pattern for the constant output range. Usually it is not necessary to change this parameter.</p>	0.0 Hz (0.0 - E3-04)	771
E3-12 (0346) Expert	Motor 2 Mid Point B Voltage	<p>V/f CL-V/f OLV CLV AOLV OLV/PM AOLV/PM CLV/PM EZOLV</p> <p>Sets a middle output voltage for the motor 2 V/f pattern. Set this parameter to adjust the V/f pattern for the constant output range. Usually it is not necessary to change this parameter.</p>	0.0 V (200 V Class: 0.0 to 255.0 V, 400 V Class: 0.0 to 510.0 V)	772
E3-13 (0347) Expert	Motor 2 Base Voltage	<p>V/f CL-V/f OLV CLV AOLV OLV/PM AOLV/PM CLV/PM EZOLV</p> <p>Sets the base voltage for the motor 2 V/f pattern. Set this parameter to adjust the V/f pattern for the constant output range. Usually it is not necessary to change this parameter.</p>	0.0 V (200 V Class: 0.0 to 255.0 V, 400 V Class: 0.0 to 510.0 V)	772

◆ E4: Motor 2 Parameters

No. (Hex.)	Name	Description	Default (Range)	Ref.
E4-01 (0321)	Motor 2 Rated Current	<p>V/f CL-V/f OLV CLV AOLV OLV/PM AOLV/PM CLV/PM EZOLV</p> <p>Sets the motor rated current for motor 2 in amps.</p>	Determined by o2-04, C6-01 (10% to 200% of the drive rated current)	772
E4-02 (0322)	Motor 2 Rated Slip	<p>V/f CL-V/f OLV CLV AOLV OLV/PM AOLV/PM CLV/PM EZOLV</p> <p>Sets the motor rated slip for motor 2.</p>	Determined by o2-04, C6-01 (0.000 - 20.000 Hz)	772
E4-03 (0323)	Motor 2 Rated No-Load Current	<p>V/f CL-V/f OLV CLV AOLV OLV/PM AOLV/PM CLV/PM EZOLV</p> <p>Sets the no-load current for motor 2 in amps when operating at the rated frequency and the no-load voltage.</p>	Determined by o2-04, C6-01 (Less than 0 - E4-01)	773
E4-04 (0324)	Motor 2 Motor Poles	<p>V/f CL-V/f OLV CLV AOLV OLV/PM AOLV/PM CLV/PM EZOLV</p> <p>Sets the number of poles for motor 2.</p>	4 (2 - 120)	773

No. (Hex.)	Name	Description	Default (Range)	Ref.
E4-05 (0325)	Motor 2 Line-to-Line Resistance	V/f CL-V/f OLV CLV AOLV OLV/PM AOLV/PM CLV/PM EZOLV Sets the line-to-line resistance for the motor 2 stator windings.	Determined by o2-04, C6-01 (0.000 - 65.000 Ω)	773
E4-06 (0326)	Motor 2 Leakage Inductance	V/f CL-V/f OLV CLV AOLV OLV/PM AOLV/PM CLV/PM EZOLV Sets the voltage drop from motor 2 leakage inductance as a percentage of Motor Rated Voltage when motor 2 operates at the rated frequency and rated current.	Determined by o2-04, C6-01 (0.0 - 60.0%)	773
E4-07 (0343)	Motor 2 Saturation Coefficient 1	V/f CL-V/f OLV CLV AOLV OLV/PM AOLV/PM CLV/PM EZOLV Sets the motor 2 iron-core saturation coefficient at 50% of the magnetic flux.	0.50 (0.00 - 0.50)	774
E4-08 (0344)	Motor 2 Saturation Coefficient 2	V/f CL-V/f OLV CLV AOLV OLV/PM AOLV/PM CLV/PM EZOLV Sets the motor 2 iron-core saturation coefficient at 75% of the magnetic flux.	0.75 (E4-07 - 0.75)	774
E4-09 (033F) Expert	Motor 2 Mechanical Loss	V/f CL-V/f OLV CLV AOLV OLV/PM AOLV/PM CLV/PM EZOLV Sets the mechanical loss of motor 2. It is set as a percentage of E4-11 [Motor 2 Rated Power]. Usually it is not necessary to change this setting.	0.0% (0.0 - 10.0%)	774
E4-10 (0340)	Motor 2 Iron Loss	V/f CL-V/f OLV CLV AOLV OLV/PM AOLV/PM CLV/PM EZOLV Sets the motor iron loss for motor 2.	Determined by o2-04, C6-01 (0 - 65535 W)	774
E4-11 (0327)	Motor 2 Rated Power	V/f CL-V/f OLV CLV AOLV OLV/PM AOLV/PM CLV/PM EZOLV Sets the motor rated power in the units from o1-58 [Motor Power Unit Selection].	Determined by o2-04, C6-01 (0.00 - 650.00 HP)	774

◆ E5: PM Motor Settings

No. (Hex.)	Name	Description	Default (Range)	Ref.
E5-01 (0329)	PM Motor Code Selection	V/f CL-V/f OLV CLV AOLV OLV/PM AOLV/PM CLV/PM EZOLV Sets the motor code for Yaskawa PM motors. The drive uses the motor code to automatically set some parameters to their correct settings.	FFFF (0000 - FFFF)	775
E5-02 (032A)	PM Motor Rated Power	V/f CL-V/f OLV CLV AOLV OLV/PM AOLV/PM CLV/PM EZOLV Sets the PM motor rated output in the units set in o1-58 [Motor Power Unit Selection].	Determined by o2-04, C6-01 (0.10 - 650.00 HP)	775
E5-03 (032B)	PM Motor Rated Current (FLA)	V/f CL-V/f OLV CLV AOLV OLV/PM AOLV/PM CLV/PM EZOLV Sets the PM motor rated current (FLA).	Determined by o2-04, C6-01 (10% to 200% of the drive rated current)	254
E5-04 (032C)	PM Motor Pole Count	V/f CL-V/f OLV CLV AOLV OLV/PM AOLV/PM CLV/PM EZOLV Sets the number of PM motor poles. Note: • When A1-02 = 7 [Control Method Selection = CLV/PM], the maximum value is 120. • When A1-02 = 5, 6 or 8 [OLV/PM, AOLV/PM or EZOLV], the maximum value is 48.	4 (2 - 120)	775
E5-05 (032D)	PM Motor Resistance (ohms/phase)	V/f CL-V/f OLV CLV AOLV OLV/PM AOLV/PM CLV/PM EZOLV Sets the resistance per phase of a PM motor. Set 50% of the line-to-line resistance.	0.100 Ω (0.000 - 65.000 Ω)	776
E5-06 (032E)	PM d-axis Inductance (mH/phase)	V/f CL-V/f OLV CLV AOLV OLV/PM AOLV/PM CLV/PM EZOLV Sets the PM motor d-axis inductance.	1.00 mH (0.00 - 300.00 mH)	776
E5-07 (032F)	PM q-axis Inductance (mH/phase)	V/f CL-V/f OLV CLV AOLV OLV/PM AOLV/PM CLV/PM EZOLV Sets the PM motor q-axis inductance.	1.00 mH (0.00 - 600.00 mH)	776
E5-09 (0331)	PM Back-EMF Vpeak (mV/(rad/s))	V/f CL-V/f OLV CLV AOLV OLV/PM AOLV/PM CLV/PM EZOLV Sets the peak value of PM motor induced voltage.	0.0 mV/(rad/sec) (0.0 - 2000.0 mV/(rad/s))	776
E5-11 (0333)	Encoder Z-Pulse Offset	V/f CL-V/f OLV CLV AOLV OLV/PM AOLV/PM CLV/PM EZOLV Sets the encoder Z-pulse offset.	0.0 degrees (-180.0 - +180.0 degrees)	777
E5-24 (0353)	PM Back-EMF L-L Vrms (mV/rpm)	V/f CL-V/f OLV CLV AOLV OLV/PM AOLV/PM CLV/PM EZOLV Sets the RMS value for PM motor line voltage.	0.1 mV/min ⁻¹ (0.0 - 6500.0 mV/min ⁻¹)	777
E5-25 (035E) Expert	Polarity Estimation Timeout	V/f CL-V/f OLV CLV AOLV OLV/PM AOLV/PM CLV/PM EZOLV Sets the function that switches polarity for initial polarity estimation. Usually it is not necessary to change this setting. 0 : Disabled 1 : Enabled	0 (0, 1)	777

◆ E9: Motor Setting

No. (Hex.)	Name	Description	Default (Range)	Ref.
E9-01 (11E4)	Motor Type Selection	<div style="display: flex; justify-content: space-between; font-size: 0.8em;"> V/f CL-V/f OLV CLV AOLV OLV/PM AOLV/PM CLV/PM EZOLV </div> <p>Sets the type of motor. 0 : Induction (IM) 1 : Permanent Magnet (PM) 2 : Synchronous Reluctance (SynRM)</p>	0 (0 to 2)	777
E9-02 (11E5)	Maximum Speed	<div style="display: flex; justify-content: space-between; font-size: 0.8em;"> V/f CL-V/f OLV CLV AOLV OLV/PM AOLV/PM CLV/PM EZOLV </div> <p>Sets the maximum speed of the motor.</p>	Determined by E9-01 (40.0 - 120.0 Hz)	778
E9-03 (11E6)	Rated Speed	<div style="display: flex; justify-content: space-between; font-size: 0.8em;"> V/f CL-V/f OLV CLV AOLV OLV/PM AOLV/PM CLV/PM EZOLV </div> <p>Sets the rated rotation speed of the motor.</p>	Determined by E9-01 (100 - 7200 min ⁻¹)	778
E9-04 (11E7)	Base Frequency	<div style="display: flex; justify-content: space-between; font-size: 0.8em;"> V/f CL-V/f OLV CLV AOLV OLV/PM AOLV/PM CLV/PM EZOLV </div> <p>Sets the rated frequency of the motor.</p>	Determined by E9-01 (40.0 - 120.0 Hz)	778
E9-05 (11E8)	Motor Rated Voltage	<div style="display: flex; justify-content: space-between; font-size: 0.8em;"> V/f CL-V/f OLV CLV AOLV OLV/PM AOLV/PM CLV/PM EZOLV </div> <p>Sets the rated voltage of the motor.</p>	200 V Class: 230.0 V, 400 V: 460.0 V (200 V Class: 0.0 - 255.0 V, 400 V Class: 0.0 - 510.0 V)	778
E9-06 (11E9)	Motor Rated Current (FLA)	<div style="display: flex; justify-content: space-between; font-size: 0.8em;"> V/f CL-V/f OLV CLV AOLV OLV/PM AOLV/PM CLV/PM EZOLV </div> <p>Sets the motor rated current in amps.</p>	Determined by E9-01 and o2-04 (10% to 200% of the drive rated current)	254
E9-07 (11EA)	Motor Rated Power	<div style="display: flex; justify-content: space-between; font-size: 0.8em;"> V/f CL-V/f OLV CLV AOLV OLV/PM AOLV/PM CLV/PM EZOLV </div> <p>Sets the motor rated output in the units from o1-58 [Motor Power Unit Selection].</p>	Determined by E9-02 and o2-04 (0.00 - 650.00 kW)	779
E9-08 (11EB)	Motor Pole Count	<div style="display: flex; justify-content: space-between; font-size: 0.8em;"> V/f CL-V/f OLV CLV AOLV OLV/PM AOLV/PM CLV/PM EZOLV </div> <p>Sets the number of motor poles.</p>	4 (2 to 120)	779
E9-09 (11EC)	Motor Rated Slip	<div style="display: flex; justify-content: space-between; font-size: 0.8em;"> V/f CL-V/f OLV CLV AOLV OLV/PM AOLV/PM CLV/PM EZOLV </div> <p>Sets the motor rated slip.</p>	0.000 Hz (0.000 - 20.000 Hz)	779
E9-10 (11ED)	Motor Line-to-Line Resistance	<div style="display: flex; justify-content: space-between; font-size: 0.8em;"> V/f CL-V/f OLV CLV AOLV OLV/PM AOLV/PM CLV/PM EZOLV </div> <p>Sets the line-to-line resistance for the motor stator windings.</p>	Determined by o2-04 (0.000 - 65.000 Ω)	779

11.9 F: Options

◆ F1: Encoder Option Setup

No. (Hex.)	Name	Description	Default (Range)	Ref.
F1-01 (0380)	Encoder 1 Pulse Count (PPR)	<input type="checkbox"/> V/f <input type="checkbox"/> CL-V/f <input type="checkbox"/> OLV <input type="checkbox"/> CLV <input type="checkbox"/> AOLV <input type="checkbox"/> OLV/PM <input type="checkbox"/> AOLV/PM <input type="checkbox"/> CLV/PM <input type="checkbox"/> EZOLV Sets the number of output pulses for each motor revolution.	1024 ppr (1 - 60000 ppr)	781
F1-02 (0381)	Encoder Signal Loss Detect Sel	<input type="checkbox"/> V/f <input type="checkbox"/> CL-V/f <input type="checkbox"/> OLV <input type="checkbox"/> CLV <input type="checkbox"/> AOLV <input type="checkbox"/> OLV/PM <input type="checkbox"/> AOLV/PM <input type="checkbox"/> CLV/PM <input type="checkbox"/> EZOLV Sets the method to stop the motor or let the motor continue operating when the drive detects <i>PGo</i> [Encoder (PG) Feedback Loss]. 0 : Ramp to Stop 1 : Coast to Stop 2 : Fast Stop (Use C1-09) 3 : Alarm Only 4 : No Alarm Display	1 (0 - 4)	781
F1-03 (0382)	Overspeed Detection Selection	<input type="checkbox"/> V/f <input type="checkbox"/> CL-V/f <input type="checkbox"/> OLV <input type="checkbox"/> CLV <input type="checkbox"/> AOLV <input type="checkbox"/> OLV/PM <input type="checkbox"/> AOLV/PM <input type="checkbox"/> CLV/PM <input type="checkbox"/> EZOLV Sets the method to stop the motor or let the motor continue operating when the drive detects <i>oS</i> [Overspeed]. 0 : Ramp to Stop 1 : Coast to Stop 2 : Fast Stop (Use C1-09) 3 : Alarm Only	1 (0 - 3)	781
F1-04 (0383)	Speed Deviation Detection Select	<input type="checkbox"/> V/f <input type="checkbox"/> CL-V/f <input type="checkbox"/> OLV <input type="checkbox"/> CLV <input type="checkbox"/> AOLV <input type="checkbox"/> OLV/PM <input type="checkbox"/> AOLV/PM <input type="checkbox"/> CLV/PM <input type="checkbox"/> EZOLV Sets the method to stop the motor or let the motor continue operating when the drive detects <i>dEv</i> [Speed Deviation]. 0 : Ramp to Stop 1 : Coast to Stop 2 : Fast Stop (Use C1-09) 3 : Alarm Only	3 (0 - 3)	782
F1-05 (0384)	Encoder 1 Rotation Selection	<input type="checkbox"/> V/f <input type="checkbox"/> CL-V/f <input type="checkbox"/> OLV <input type="checkbox"/> CLV <input type="checkbox"/> AOLV <input type="checkbox"/> OLV/PM <input type="checkbox"/> AOLV/PM <input type="checkbox"/> CLV/PM <input type="checkbox"/> EZOLV Sets the output sequence for the A and B pulses from the encoder, assuming that the motor is operating in the forward direction. 0 : Pulse A leads in FWD Direction 1 : Pulse B leads in FWD Direction	Determined by A1-02 (0, 1)	782
F1-06 (0385)	Encoder 1 Pulse Monitor Scaling	<input type="checkbox"/> V/f <input type="checkbox"/> CL-V/f <input type="checkbox"/> OLV <input type="checkbox"/> CLV <input type="checkbox"/> AOLV <input type="checkbox"/> OLV/PM <input type="checkbox"/> AOLV/PM <input type="checkbox"/> CLV/PM <input type="checkbox"/> EZOLV Sets the ratio between the pulse input and the pulse output of the encoder as a 3-digit number. The first digit is the numerator and the second and third digits set the denominator. The dividing ratio = (1 + x)/yz when the setting value is a 3-digit value (xyz).	001 (001 - 032, 102 - 132 (1 - 1/32))	783
F1-08 (0387)	Overspeed Detection Level	<input type="checkbox"/> V/f <input type="checkbox"/> CL-V/f <input type="checkbox"/> OLV <input type="checkbox"/> CLV <input type="checkbox"/> AOLV <input type="checkbox"/> OLV/PM <input type="checkbox"/> AOLV/PM <input type="checkbox"/> CLV/PM <input type="checkbox"/> EZOLV Sets the detection level of <i>oS</i> [Overspeed] as a percentage when the maximum output frequency is 100%. Note: • Parameter <i>A1-02</i> [Control Method Selection] selects which parameter is the maximum output frequency. – <i>A1-02</i> ≠ 8 [EZOLV]: <i>E1-04</i> [Maximum Output Frequency] – <i>A1-02</i> = 8: <i>E9-02</i> [Maximum Speed] • If <i>A1-02</i> = 0 [Control Method Selection = V/f], you must set <i>H6-01</i> = 3 [Terminal RP Pulse Train Function = Speed Feedback (V/F Control)] to enable this parameter.	115% (0 - 120%)	783
F1-09 (0388)	Overspeed Detection Delay Time	<input type="checkbox"/> V/f <input type="checkbox"/> CL-V/f <input type="checkbox"/> OLV <input type="checkbox"/> CLV <input type="checkbox"/> AOLV <input type="checkbox"/> OLV/PM <input type="checkbox"/> AOLV/PM <input type="checkbox"/> CLV/PM <input type="checkbox"/> EZOLV Sets the length of time that the speed feedback must be more than the <i>F1-08</i> level to cause <i>oS</i> [Overspeed]. Note: If <i>A1-02</i> = 0 [Control Method Selection = V/f], you must set <i>H6-01</i> = 3 [Terminal RP Pulse Train Function = Speed Feedback (V/F Control)] to enable this parameter.	Determined by A1-02 (0.0 - 2.0 s)	783
F1-10 (0389)	Speed Deviation Detection Level	<input type="checkbox"/> V/f <input type="checkbox"/> CL-V/f <input type="checkbox"/> OLV <input type="checkbox"/> CLV <input type="checkbox"/> AOLV <input type="checkbox"/> OLV/PM <input type="checkbox"/> AOLV/PM <input type="checkbox"/> CLV/PM <input type="checkbox"/> EZOLV Sets the detection level of <i>dEv</i> [Speed Deviation] as a percentage when the maximum output frequency is 100%. Note: • Parameter <i>A1-02</i> [Control Method Selection] selects which parameter is the maximum output frequency. – <i>A1-02</i> ≠ 8 [EZOLV]: <i>E1-04</i> [Maximum Output Frequency] – <i>A1-02</i> = 8: <i>E9-02</i> [Maximum Speed] • If <i>A1-02</i> = 0 [Control Method Selection = V/f], you must set <i>H6-01</i> = 3 [Terminal RP Pulse Train Function = Speed Feedback (V/F Control)] to enable this parameter.	10% (0 - 50%)	783

11.9 F: Options

No. (Hex.)	Name	Description	Default (Range)	Ref.
F1-11 (038A)	Speed Deviation Detect DelayTime	<p><input type="checkbox"/> V/f <input checked="" type="checkbox"/> CL-V/f <input type="checkbox"/> OLV <input type="checkbox"/> CLV <input type="checkbox"/> AOLV <input type="checkbox"/> OLV/PM <input type="checkbox"/> AOLV/PM <input type="checkbox"/> CLV/PM <input type="checkbox"/> EZOLV</p> <p>Sets the length of time that the difference between the frequency reference and speed feedback must be more than the level in F1-10 to cause dEv [Speed Deviation].</p> <p>Note: If A1-02 = 0 [Control Method Selection = V/f], you must set H6-01 = 3 [Terminal RP Pulse Train Function = Speed Feedback (V/F Control)] to enable this parameter.</p>	0.5 s (0.0 - 10.0 s)	783
F1-12 (038B)	Encoder 1 Gear Teeth 1	<p><input type="checkbox"/> V/f <input checked="" type="checkbox"/> CL-V/f <input type="checkbox"/> OLV <input type="checkbox"/> CLV <input type="checkbox"/> AOLV <input type="checkbox"/> OLV/PM <input type="checkbox"/> AOLV/PM <input type="checkbox"/> CLV/PM <input type="checkbox"/> EZOLV</p> <p>Sets the number of gear teeth on the motor side. This parameter and F1-13 [Encoder 1 Gear Teeth 2] set the gear ratio between the motor and encoder.</p>	0 (0 - 1000)	783
F1-13 (038C)	Encoder 2 Gear Teeth 1	<p><input type="checkbox"/> V/f <input checked="" type="checkbox"/> CL-V/f <input type="checkbox"/> OLV <input type="checkbox"/> CLV <input type="checkbox"/> AOLV <input type="checkbox"/> OLV/PM <input type="checkbox"/> AOLV/PM <input type="checkbox"/> CLV/PM <input type="checkbox"/> EZOLV</p> <p>Sets the number of gear teeth on the load side. This parameter and F1-12 [Encoder 1 Gear Teeth 1] set the gear ratio between the motor and encoder.</p>	0 (0 - 1000)	784
F1-14 (038D)	Encoder Open-Circuit Detect Time	<p><input type="checkbox"/> V/f <input checked="" type="checkbox"/> CL-V/f <input type="checkbox"/> OLV <input type="checkbox"/> CLV <input type="checkbox"/> AOLV <input type="checkbox"/> OLV/PM <input type="checkbox"/> AOLV/PM <input type="checkbox"/> CLV/PM <input type="checkbox"/> EZOLV</p> <p>Sets the length of time that the drive must not receive a pulse signal to cause PGo [Encoder (PG) Feedback Loss].</p> <p>Note: Motor speed and load conditions can cause ov [Overvoltage] and oC [Overcurrent] faults. If A1-02 = 0 [Control Method Selection = V/f], you must set H6-01 = 3 [Terminal RP Pulse Train Function = Speed Feedback (V/F Control)] to enable this parameter.</p>	2.0 s (0.0 - 10.0 s)	784
F1-17 (03AC)	Deviation 2 Detection Selection	<p><input type="checkbox"/> V/f <input type="checkbox"/> CL-V/f <input type="checkbox"/> OLV <input type="checkbox"/> CLV <input type="checkbox"/> AOLV <input type="checkbox"/> OLV/PM <input type="checkbox"/> AOLV/PM <input checked="" type="checkbox"/> CLV/PM <input type="checkbox"/> EZOLV</p> <p>Usually it is not necessary to change this setting. Sets the number of motor rotations that the drive will detect more than one Z pulse per rotation to detect dv2.</p>	10 (0 - 100)	784
F1-18 (03AD)	Deviation 3 Detection Selection	<p><input type="checkbox"/> V/f <input type="checkbox"/> CL-V/f <input type="checkbox"/> OLV <input type="checkbox"/> CLV <input type="checkbox"/> AOLV <input type="checkbox"/> OLV/PM <input type="checkbox"/> AOLV/PM <input checked="" type="checkbox"/> CLV/PM <input type="checkbox"/> EZOLV</p> <p>Sets the number of rotations necessary to detect conditions that invert the torque reference and rate of acceleration and cause dv3 [Inversion Detection].</p>	10 (0 - 10)	784
F1-19 (03AE)	Deviation 4 Detection Selection	<p><input type="checkbox"/> V/f <input type="checkbox"/> CL-V/f <input type="checkbox"/> OLV <input type="checkbox"/> CLV <input type="checkbox"/> AOLV <input type="checkbox"/> OLV/PM <input type="checkbox"/> AOLV/PM <input checked="" type="checkbox"/> CLV/PM <input type="checkbox"/> EZOLV</p> <p>Sets the number of pulses necessary to cause dv4 [Inversion Prevention Detection].</p>	128 (0 - 5000)	785
F1-20 (03B4)	Encoder 1 PCB Disconnect Detect	<p><input type="checkbox"/> V/f <input checked="" type="checkbox"/> CL-V/f <input type="checkbox"/> OLV <input type="checkbox"/> CLV <input type="checkbox"/> AOLV <input type="checkbox"/> OLV/PM <input type="checkbox"/> AOLV/PM <input checked="" type="checkbox"/> CLV/PM <input type="checkbox"/> EZOLV</p> <p>Sets the function that enables and disables detection of a disconnected encoder connection cable to cause PGoH [Encoder (PG) Hardware Fault]. 0 : No 1 : Yes</p>	1 (0, 1)	785
F1-21 (03BC)	Encoder 1 Signal Selection	<p><input type="checkbox"/> V/f <input checked="" type="checkbox"/> CL-V/f <input type="checkbox"/> OLV <input type="checkbox"/> CLV <input type="checkbox"/> AOLV <input type="checkbox"/> OLV/PM <input type="checkbox"/> AOLV/PM <input type="checkbox"/> CLV/PM <input type="checkbox"/> EZOLV</p> <p>Sets the number of channels for the signal to the encoder option card. 0 : A Pulse Detection 1 : AB Pulse Detection</p>	0 (0, 1)	785
F1-30 (03AA)	Motor 2 Encoder PCB Port Select	<p><input type="checkbox"/> V/f <input checked="" type="checkbox"/> CL-V/f <input type="checkbox"/> OLV <input type="checkbox"/> CLV <input type="checkbox"/> AOLV <input type="checkbox"/> OLV/PM <input type="checkbox"/> AOLV/PM <input type="checkbox"/> CLV/PM <input type="checkbox"/> EZOLV</p> <p>Sets the drive port to install the motor 2 encoder option card. 0 : CN5-C 1 : CN5-B</p>	1 (0, 1)	785
F1-31 (03B0)	Encoder 2 Pulse Count (PPR)	<p><input type="checkbox"/> V/f <input type="checkbox"/> CL-V/f <input type="checkbox"/> OLV <input checked="" type="checkbox"/> CLV <input type="checkbox"/> AOLV <input type="checkbox"/> OLV/PM <input type="checkbox"/> AOLV/PM <input type="checkbox"/> CLV/PM <input type="checkbox"/> EZOLV</p> <p>Sets the number of output pulses for each motor revolution for motor 2.</p>	1024 ppr (1 - 60000 ppr)	785
F1-32 (03B1)	Encoder 2 Rotation Selection	<p><input type="checkbox"/> V/f <input type="checkbox"/> CL-V/f <input type="checkbox"/> OLV <input checked="" type="checkbox"/> CLV <input type="checkbox"/> AOLV <input type="checkbox"/> OLV/PM <input type="checkbox"/> AOLV/PM <input type="checkbox"/> CLV/PM <input type="checkbox"/> EZOLV</p> <p>Sets the output sequence for the A and B pulses from the encoder for motor 2. This parameter assumes that the motor is operating in the forward direction. 0 : Pulse A leads in FWD Direction 1 : Pulse B leads in FWD Direction</p>	0 (0, 1)	785
F1-33 (03B2)	Encoder 2 Gear Teeth 1	<p><input type="checkbox"/> V/f <input checked="" type="checkbox"/> CL-V/f <input type="checkbox"/> OLV <input type="checkbox"/> CLV <input type="checkbox"/> AOLV <input type="checkbox"/> OLV/PM <input type="checkbox"/> AOLV/PM <input type="checkbox"/> CLV/PM <input type="checkbox"/> EZOLV</p> <p>Sets the number of gear teeth on the motor side for motor 2. This parameter and F1-34 [Encoder 2 Gear Teeth 2] set the gear ratio between the motor and encoder.</p>	0 (0 - 1000)	786
F1-34 (03B3)	Encoder 2 Gear Teeth 2	<p><input type="checkbox"/> V/f <input type="checkbox"/> CL-V/f <input type="checkbox"/> OLV <input checked="" type="checkbox"/> CLV <input type="checkbox"/> AOLV <input type="checkbox"/> OLV/PM <input type="checkbox"/> AOLV/PM <input type="checkbox"/> CLV/PM <input type="checkbox"/> EZOLV</p> <p>Sets the number of gear teeth on the load side for motor 2. This parameter and F1-33 [Encoder 2 Gear Teeth 1] set the gear ratio between the motor and encoder.</p>	0 (0 - 1000)	786
F1-35 (03BE)	Encoder 2 Pulse Monitor Scaling	<p><input type="checkbox"/> V/f <input type="checkbox"/> CL-V/f <input type="checkbox"/> OLV <input checked="" type="checkbox"/> CLV <input type="checkbox"/> AOLV <input type="checkbox"/> OLV/PM <input type="checkbox"/> AOLV/PM <input type="checkbox"/> CLV/PM <input type="checkbox"/> EZOLV</p> <p>Sets the ratio between the pulse input and the pulse output of the encoder as a 3-digit number for motor 2. The first digit is the numerator and the second and third digits set the denominator. The dividing ratio = (1 + x)/yz when the setting value is a 3-digit value (xyz).</p>	001 (001 - 032, 102 - 132 (1 - 1/32))	786
F1-36 (03B5)	Encoder 2 PCB Disconnect Detect	<p><input type="checkbox"/> V/f <input type="checkbox"/> CL-V/f <input type="checkbox"/> OLV <input checked="" type="checkbox"/> CLV <input type="checkbox"/> AOLV <input type="checkbox"/> OLV/PM <input type="checkbox"/> AOLV/PM <input type="checkbox"/> CLV/PM <input type="checkbox"/> EZOLV</p> <p>Sets the function that enables and disables detection of a disconnected encoder connection cable to cause PGoH [Encoder (PG) Hardware Fault] for motor 2. 0 : Disabled 1 : Enabled</p>	1 (0, 1)	786

No. (Hex.)	Name	Description	Default (Range)	Ref.
F1-37 (03BD)	Encoder 2 Signal Selection	<input type="checkbox"/> V/f <input checked="" type="checkbox"/> CL-V/f <input type="checkbox"/> OLV <input type="checkbox"/> CLV <input type="checkbox"/> AOLV <input type="checkbox"/> OLV/PM <input type="checkbox"/> AOLV/PM <input type="checkbox"/> CLV/PM <input type="checkbox"/> EZOLV Sets the number of channels for the signal to the encoder option card for motor 2. 0 : A Pulse Detection 1 : AB Pulse Detection	0 (0, 1)	787
F1-46 (1B98)	Deviation 2 Detection Method Selection	<input type="checkbox"/> V/f <input checked="" type="checkbox"/> CL-V/f <input type="checkbox"/> OLV <input type="checkbox"/> CLV <input type="checkbox"/> AOLV <input type="checkbox"/> OLV/PM <input type="checkbox"/> AOLV/PM <input checked="" type="checkbox"/> CLV/PM <input type="checkbox"/> EZOLV Usually it is not necessary to change this setting. Sets the detection method for <i>dv2</i> [<i>Z Pulse Noise Fault Detection</i>].	0 (0, 1)	787
F1-47 (1B99)	Deviation 2 Detection Selection	<input type="checkbox"/> V/f <input checked="" type="checkbox"/> CL-V/f <input type="checkbox"/> OLV <input type="checkbox"/> CLV <input type="checkbox"/> AOLV <input type="checkbox"/> OLV/PM <input type="checkbox"/> AOLV/PM <input checked="" type="checkbox"/> CLV/PM <input type="checkbox"/> EZOLV Usually it is not necessary to change this setting. Sets the sensitivity of detection for <i>dv2</i> [<i>Z Pulse Noise Fault Detection</i>]. Increase the value to decrease the sensitivity.	15° (0 - 180°)	787
F1-50 (03D2)	PG-F3 Option Encoder Type	<input type="checkbox"/> V/f <input checked="" type="checkbox"/> CL-V/f <input type="checkbox"/> OLV <input type="checkbox"/> CLV <input type="checkbox"/> AOLV <input type="checkbox"/> OLV/PM <input type="checkbox"/> AOLV/PM <input checked="" type="checkbox"/> CLV/PM <input type="checkbox"/> EZOLV Sets the type of encoder connected to the PG-F3 option. 0 : EnDat Sin/Cos 1 : EnDat Serial Only 2 : HIPERFACE	0 (0 - 2)	787
F1-51 (03D3)	PG-F3 PGoH Detection Level	<input type="checkbox"/> V/f <input checked="" type="checkbox"/> CL-V/f <input type="checkbox"/> OLV <input type="checkbox"/> CLV <input type="checkbox"/> AOLV <input type="checkbox"/> OLV/PM <input type="checkbox"/> AOLV/PM <input checked="" type="checkbox"/> CLV/PM <input type="checkbox"/> EZOLV The drive will detect <i>PGoH</i> [<i>Encoder (PG) Hardware Fault</i>] if the value of this parameter is smaller than the value of $\sqrt{\sin^2\theta + \cos^2\theta}$. Note: This function is enabled when <i>F1-20</i> = 1 [<i>Encoder 1 PCB Disconnect Detect = Enabled</i>].	80% (1 - 100%)	787
F1-52 (03D4)	Serial Encoder Comm Speed	<input type="checkbox"/> V/f <input checked="" type="checkbox"/> CL-V/f <input type="checkbox"/> OLV <input type="checkbox"/> CLV <input type="checkbox"/> AOLV <input type="checkbox"/> OLV/PM <input type="checkbox"/> AOLV/PM <input checked="" type="checkbox"/> CLV/PM <input type="checkbox"/> EZOLV Sets the communication speed between the PG-F3 option and the serial encoder. 0 : 1M/9600bps 1 : 500k/19200bps 2 : 1M/38400bps	0 (0 - 2)	788

◆ F2: Analog Input Option

No. (Hex.)	Name	Description	Default (Range)	Ref.
F2-01 (038F)	Analog Input Function Selection	<input checked="" type="checkbox"/> V/f <input checked="" type="checkbox"/> CL-V/f <input type="checkbox"/> OLV <input type="checkbox"/> CLV <input type="checkbox"/> AOLV <input type="checkbox"/> OLV/PM <input type="checkbox"/> AOLV/PM <input type="checkbox"/> CLV/PM <input type="checkbox"/> EZOLV Sets the input method for the analog reference used with AI-A3. 0 : 3 Independent Channels 1 : 3 Channels Added Together	0 (0, 1)	788
F2-02 (0368) RUN	Analog Input Option Card Gain	<input type="checkbox"/> V/f <input checked="" type="checkbox"/> CL-V/f <input type="checkbox"/> OLV <input type="checkbox"/> CLV <input type="checkbox"/> AOLV <input type="checkbox"/> OLV/PM <input type="checkbox"/> AOLV/PM <input type="checkbox"/> CLV/PM <input type="checkbox"/> EZOLV Sets the analog reference gain as a percentage when the maximum output frequency is 100%. Note: • Set <i>F2-01</i> = 1 [<i>Analog Input Function Selection = 3 Channels Added Together</i>] to enable this function. • Parameter <i>A1-02</i> [<i>Control Method Selection</i>] selects which parameter is the maximum output frequency. – <i>A1-02</i> ≠ 8 [<i>EZOLV</i>]: <i>E1-04</i> [<i>Maximum Output Frequency</i>] – <i>A1-02</i> = 8: <i>E9-02</i> [<i>Maximum Speed</i>]	100.0% (-999.9 - +999.9%)	790
F2-03 (0369) RUN	Analog Input Option Card Bias	<input type="checkbox"/> V/f <input checked="" type="checkbox"/> CL-V/f <input type="checkbox"/> OLV <input type="checkbox"/> CLV <input type="checkbox"/> AOLV <input type="checkbox"/> OLV/PM <input type="checkbox"/> AOLV/PM <input type="checkbox"/> CLV/PM <input type="checkbox"/> EZOLV Sets the analog reference bias as a percentage when the maximum output frequency is 100%. Note: • Set <i>F2-01</i> = 1 [<i>Analog Input Function Selection = 3 Channels Added Together</i>] to enable this function. • Parameter <i>A1-02</i> [<i>Control Method Selection</i>] selects which parameter is the maximum output frequency. – <i>A1-02</i> ≠ 8 [<i>EZOLV</i>]: <i>E1-04</i> [<i>Maximum Output Frequency</i>] – <i>A1-02</i> = 8: <i>E9-02</i> [<i>Maximum Speed</i>]	0.0% (-999.9 - +999.9%)	790

◆ F3: Digital Input Option

No. (Hex.)	Name	Description	Default (Range)	Ref.
F3-01 (0390)	Digital Input Function Selection	<p>V/f CL-V/f OLV CLV AOLV OLV/PM AOLV/PM CLV/PM EZOLV</p> <p>Sets the data format of digital input signals. This parameter is enabled when <i>o1-03 = 0</i> or <i>1</i> [<i>Frequency Display Unit Selection = 0.01 Hz or 0.01% (100% = E1-04)</i>].</p> <p>Note: When <i>o1-03 = 2</i> or <i>3</i> [<i>Revolutions Per Minute (RPM) or User Units (o1-10 & o1-11)</i>], the input signal will be BCD. The <i>o1-03</i> value sets the setting units.</p> <p>0 : BCD, 1% units 1 : BCD, 0.1% units 2 : BCD, 0.01% units 3 : BCD, 1 Hz units 4 : BCD, 0.1 Hz units 5 : BCD, 0.01 Hz units 6 : BCD (5-digit), 0.02 Hz 7 : Binary input 8 : Multi-Function Digital Input</p>	8 (0 - 8)	791
F3-03 (03B9)	Digital Input Data Length Select	<p>V/f CL-V/f OLV CLV AOLV OLV/PM AOLV/PM CLV/PM EZOLV</p> <p>Sets the number of bits to set the frequency reference with <i>DI-A3</i>.</p> <p>0 : 8-bit 1 : 12-bit 2 : 16-bit</p>	2 (0 - 2)	791
F3-10 (0BE3) Expert	Terminal D0 Function Selection	<p>V/f CL-V/f OLV CLV AOLV OLV/PM AOLV/PM CLV/PM EZOLV</p> <p>Sets the function for terminal D0 of the <i>DI-A3</i> option when <i>F3-01 = 8</i> [<i>Digital Input Function Selection = Multi-Function Digital Input</i>].</p>	F (1 - 19F)	792
F3-11 (0BE4) Expert	Terminal D1 Function Selection	<p>V/f CL-V/f OLV CLV AOLV OLV/PM AOLV/PM CLV/PM EZOLV</p> <p>Sets the function for terminal D1 of the <i>DI-A3</i> option when <i>F3-01 = 8</i> [<i>Digital Input Function Selection = Multi-Function Digital Input</i>].</p>	F (1 - 19F)	792
F3-12 (0BE5) Expert	Terminal D2 Function Selection	<p>V/f CL-V/f OLV CLV AOLV OLV/PM AOLV/PM CLV/PM EZOLV</p> <p>Sets the function for terminal D2 of the <i>DI-A3</i> option when <i>F3-01 = 8</i> [<i>Digital Input Function Selection = Multi-Function Digital Input</i>].</p>	F (1 - 19F)	793
F3-13 (0BE6) Expert	Terminal D3 Function Selection	<p>V/f CL-V/f OLV CLV AOLV OLV/PM AOLV/PM CLV/PM EZOLV</p> <p>Sets the function for terminal D3 of the <i>DI-A3</i> option when <i>F3-01 = 8</i> [<i>Digital Input Function Selection = Multi-Function Digital Input</i>].</p>	F (1 - 19F)	793
F3-14 (0BE7) Expert	Terminal D4 Function Selection	<p>V/f CL-V/f OLV CLV AOLV OLV/PM AOLV/PM CLV/PM EZOLV</p> <p>Sets the function for terminal D4 of the <i>DI-A3</i> option when <i>F3-01 = 8</i> [<i>Digital Input Function Selection = Multi-Function Digital Input</i>].</p>	F (1 - 19F)	793
F3-15 (0BE8) Expert	Terminal D5 Function Selection	<p>V/f CL-V/f OLV CLV AOLV OLV/PM AOLV/PM CLV/PM EZOLV</p> <p>Sets the function for terminal D5 of the <i>DI-A3</i> option when <i>F3-01 = 8</i> [<i>Digital Input Function Selection = Multi-Function Digital Input</i>].</p>	F (1 - 19F)	793
F3-16 (0BE9) Expert	Terminal D6 Function Selection	<p>V/f CL-V/f OLV CLV AOLV OLV/PM AOLV/PM CLV/PM EZOLV</p> <p>Sets the function for terminal D6 of the <i>DI-A3</i> option when <i>F3-01 = 8</i> [<i>Digital Input Function Selection = Multi-Function Digital Input</i>].</p>	F (1 - 19F)	793
F3-17 (0BEA) Expert	Terminal D7 Function Selection	<p>V/f CL-V/f OLV CLV AOLV OLV/PM AOLV/PM CLV/PM EZOLV</p> <p>Sets the function for terminal D7 of the <i>DI-A3</i> option when <i>F3-01 = 8</i> [<i>Digital Input Function Selection = Multi-Function Digital Input</i>].</p>	F (1 - 19F)	793
F3-18 (0BEB) Expert	Terminal D8 Function Selection	<p>V/f CL-V/f OLV CLV AOLV OLV/PM AOLV/PM CLV/PM EZOLV</p> <p>Sets the function for terminal D8 of the <i>DI-A3</i> option when <i>F3-01 = 8</i> [<i>Digital Input Function Selection = Multi-Function Digital Input</i>].</p>	F (1 - 19F)	793
F3-19 (0BEC) Expert	Terminal D9 Function Selection	<p>V/f CL-V/f OLV CLV AOLV OLV/PM AOLV/PM CLV/PM EZOLV</p> <p>Sets the function for terminal D9 of the <i>DI-A3</i> option when <i>F3-01 = 8</i> [<i>Digital Input Function Selection = Multi-Function Digital Input</i>].</p>	F (1 - 19F)	794
F3-20 (0BED) Expert	Terminal DA Function Selection	<p>V/f CL-V/f OLV CLV AOLV OLV/PM AOLV/PM CLV/PM EZOLV</p> <p>Sets the function for terminal DA of the <i>DI-A3</i> option when <i>F3-01 = 8</i> [<i>Digital Input Function Selection = Multi-Function Digital Input</i>].</p>	F (1 - 19F)	794
F3-21 (0BEE) Expert	Terminal DB Function Selection	<p>V/f CL-V/f OLV CLV AOLV OLV/PM AOLV/PM CLV/PM EZOLV</p> <p>Sets the function for terminal DB of the <i>DI-A3</i> option when <i>F3-01 = 8</i> [<i>Digital Input Function Selection = Multi-Function Digital Input</i>].</p>	F (1 - 19F)	794

No. (Hex.)	Name	Description	Default (Range)	Ref.
F3-22 (0BEF) Expert	Terminal DC Function Selection	V/f CL-V/f OLV CLV AOLV OLV/PM AOLV/PM CLV/PM EZOLV Sets the function for terminal DC of the DI-A3 option when F3-01 = 8 [Digital Input Function Selection = Multi-Function Digital Input].	F (1 - 19F)	794
F3-23 (0BF0) Expert	Terminal DD Function Selection	V/f CL-V/f OLV CLV AOLV OLV/PM AOLV/PM CLV/PM EZOLV Sets the function for terminal DD of the DI-A3 option when F3-01 = 8 [Digital Input Function Selection = Multi-Function Digital Input].	F (1 - 19F)	794
F3-24 (0BF1) Expert	Terminal DE Function Selection	V/f CL-V/f OLV CLV AOLV OLV/PM AOLV/PM CLV/PM EZOLV Sets the function for terminal DE of the DI-A3 option when F3-01 = 8 [Digital Input Function Selection = Multi-Function Digital Input].	F (1 - 19F)	794
F3-25 (0BF2) Expert	Terminal DF Function Selection	V/f CL-V/f OLV CLV AOLV OLV/PM AOLV/PM CLV/PM EZOLV Sets the function for terminal DF of the DI-A3 option when F3-01 = 8 [Digital Input Function Selection = Multi-Function Digital Input].	F (1 - 19F)	794

◆ F4: Analog Output Option

No. (Hex.)	Name	Description	Default (Range)	Ref.
F4-01 (0391)	Terminal V1 Function Selection	V/f CL-V/f OLV CLV AOLV OLV/PM AOLV/PM CLV/PM EZOLV Sets the monitor signal output from terminal V1. Set the x-xx part of the Ux-xx [Monitor]. For example, set F4-01 = 102 to monitor U1-02 [Output Frequency].	102 (000 - 999)	795
F4-02 (0392) RUN	Terminal V1 Gain	V/f CL-V/f OLV CLV AOLV OLV/PM AOLV/PM CLV/PM EZOLV Sets the gain of the monitor signal that is sent from terminal V1. Sets the analog signal output level from the terminal V1 at 10 V or 20 mA as 100% when an output for monitoring items is 100%.	100.0% (-999.9 - +999.9%)	795
F4-03 (0393)	Terminal V2 Function Selection	V/f CL-V/f OLV CLV AOLV OLV/PM AOLV/PM CLV/PM EZOLV Sets the monitor signal output from terminal V2. Set the x-xx part of the Ux-xx [Monitor]. For example, set F4-03 = 103 to monitor U1-03 [Output Current].	103 (000 - 999)	796
F4-04 (0394) RUN	Terminal V2 Gain	V/f CL-V/f OLV CLV AOLV OLV/PM AOLV/PM CLV/PM EZOLV Sets the gain of the monitor signal that is sent from terminal V2. Sets the analog signal output level from terminal V2 at 10 V or 20 mA as 100% when an output for monitoring items is 100%.	50.0% (-999.9 - +999.9%)	796
F4-05 (0395) RUN	Terminal V1 Bias	V/f CL-V/f OLV CLV AOLV OLV/PM AOLV/PM CLV/PM EZOLV Sets the bias of the monitor signal that is sent from terminal V1. When an output for monitoring items is 0%, this parameter sets the analog signal output level from the V1 terminal as a percentage of 10 V or 20 mA.	0.0% (-999.9 - +999.9%)	796
F4-06 (0396) RUN	Terminal V2 Bias	V/f CL-V/f OLV CLV AOLV OLV/PM AOLV/PM CLV/PM EZOLV Sets the bias of the monitor signal that is sent from terminal V2. Set the level of the analog signal sent from the V2 terminal at 10 V or 20 mA as 100% when an output for monitoring items is 0%.	0.0% (-999.9 - +999.9%)	796
F4-07 (0397)	Terminal V1 Signal Level	V/f CL-V/f OLV CLV AOLV OLV/PM AOLV/PM CLV/PM EZOLV Sets the output signal level for terminal V1. 0 : 0 to 10 V 1 : -10 to 10 V	0 (0, 1)	797
F4-08 (0398)	Terminal V2 Signal Level	V/f CL-V/f OLV CLV AOLV OLV/PM AOLV/PM CLV/PM EZOLV Sets the output signal level for terminal V2. 0 : 0 to 10 V 1 : -10 to 10 V	0 (0, 1)	797

◆ F5: Digital Output Option

No. (Hex.)	Name	Description	Default (Range)	Ref.
F5-01 (0399)	Terminal P1-PC Function Select	V/f CL-V/f OLV CLV AOLV OLV/PM AOLV/PM CLV/PM EZOLV Sets the function of terminal P1-PC on the DO-A3 option. Set F5-09 = 2 [DO-A3 Output Mode Selection = Programmable (F5-01 to F5-08)] to enable this function.	0 (0 - 1A7)	798
F5-02 (039A)	Terminal P2-PC Function Select	V/f CL-V/f OLV CLV AOLV OLV/PM AOLV/PM CLV/PM EZOLV Sets the function of terminal P2-PC on the DO-A3 option. Set F5-09 = 2 [DO-A3 Output Mode Selection = Programmable (F5-01 to F5-08)] to enable this function.	1 (0 - 1A7)	798

11.9 F: Options

No. (Hex.)	Name	Description	Default (Range)	Ref.
F5-03 (039B)	Terminal P3-PC Function Select	V/f CL-V/f OLV CLV AOLV OLV/PM AOLV/PM CLV/PM EZOLV Sets the function of terminal P3-PC on the DO-A3 option. Set $F5-09 = 2$ [DO-A3 Output Mode Selection = Programmable (F5-01 to F5-08)] to enable this function.	2 (0 - 1A7)	799
F5-04 (039C)	Terminal P4-PC Function Select	V/f CL-V/f OLV CLV AOLV OLV/PM AOLV/PM CLV/PM EZOLV Sets the function of terminal P4-PC on the DO-A3 option. Set $F5-09 = 2$ [DO-A3 Output Mode Selection = Programmable (F5-01 to F5-08)] to enable this function.	4 (0 - 1A7)	799
F5-05 (039D)	Terminal P5-PC Function Select	V/f CL-V/f OLV CLV AOLV OLV/PM AOLV/PM CLV/PM EZOLV Sets the function of terminal P5-PC on the DO-A3 option. Set $F5-09 = 2$ [DO-A3 Output Mode Selection = Programmable (F5-01 to F5-08)] to enable this function.	6 (0 - 1A7)	799
F5-06 (039E)	Terminal P6-PC Function Select	V/f CL-V/f OLV CLV AOLV OLV/PM AOLV/PM CLV/PM EZOLV Sets the function of terminal P6-PC on the DO-A3 option. Set $F5-09 = 2$ [DO-A3 Output Mode Selection = Programmable (F5-01 to F5-08)] to enable this function.	37 (0 - 1A7)	799
F5-07 (039F)	Terminal M1-M2 Function Select	V/f CL-V/f OLV CLV AOLV OLV/PM AOLV/PM CLV/PM EZOLV Sets the function of terminal M3-M2 on the DO-A3 option. Set $F5-09 = 2$ [DO-A3 Output Mode Selection = Programmable (F5-01 to F5-08)] to enable this function.	F (0 - 1A7)	799
F5-08 (03A0)	Terminal M3-M4 Function Select	V/f CL-V/f OLV CLV AOLV OLV/PM AOLV/PM CLV/PM EZOLV Sets the function of terminal M3-M4 on the DO-A3 option. Set $F5-09 = 2$ [DO-A3 Output Mode Selection = Programmable (F5-01 to F5-08)] to enable this function.	F (0 - 1A7)	799
F5-09 (03A1)	DO-A3 Output Mode Selection	V/f CL-V/f OLV CLV AOLV OLV/PM AOLV/PM CLV/PM EZOLV Sets the output mode of signals from the DO-A3 option. 0 : Predefined Individual Outputs 1 : Binary Output 2 : Programmable (F5-01 to F5-08)	0 (0 - 2)	799

◆ F6: Communication Options

No. (Hex.)	Name	Description	Default (Range)	Ref.
F6-01 (03A2)	Communication Error Selection	V/f CL-V/f OLV CLV AOLV OLV/PM AOLV/PM CLV/PM EZOLV Sets the method to stop the motor or let the motor continue operating when the drive detects a bUS [Option Communication Error]. 0 : Ramp to Stop 1 : Coast to Stop 2 : Fast Stop 3 : Alarm Only 4 : Alarm (Run at d1-04) 5 : Alarm - Ramp Stop	1 (0 - 5)	805
F6-02 (03A3)	Comm External Fault (EF0) Detect	V/f CL-V/f OLV CLV AOLV OLV/PM AOLV/PM CLV/PM EZOLV Sets the conditions at which EF0 [Option Card External Fault] is detected. 0 : Always Detected 1 : Detected during RUN Only	0 (0, 1)	806
F6-03 (03A4)	Comm External Fault (EF0) Select	V/f CL-V/f OLV CLV AOLV OLV/PM AOLV/PM CLV/PM EZOLV Sets the method to stop the motor or let the motor continue operating when the drive detects an EF0 [Option Card External Fault]. 0 : Ramp to Stop 1 : Coast to Stop 2 : Fast Stop (Use C1-09) 3 : Alarm Only	1 (0 - 3)	806
F6-04 (03A5)	bUS Error Detection Time	V/f CL-V/f OLV CLV AOLV OLV/PM AOLV/PM CLV/PM EZOLV Sets the delay time for the drive to detect bUS [Option Communication Error]. Note: When you install an option card in the drive, the parameter value changes to 0.0 s.	2.0 s (0.0 - 5.0 s)	806
F6-06 (03A7)	Torque Reference/Limit by Comm	V/f CL-V/f OLV CLV AOLV OLV/PM AOLV/PM CLV/PM EZOLV Sets the function that enables and disables the torque reference and torque limit received from the communication option. 0 : Disabled 1 : Enabled	0 (0, 1)	806

No. (Hex.)	Name	Description	Default (Range)	Ref.
F6-07 (03A8)	Multi-Step Ref @ NetRef/ComRef	V/f CL-V/f OLV CLV AOLV OLV/PM AOLV/PM CLV/PM EZOLV Sets the function that enables and disables the multi-step speed reference when the frequency reference source is NetRef or ComRef (communication option card or MEMOBUS/Modbus communications). 0 : Disable Multi-Step References 1 : Enable Multi-Step References	0 (0, 1)	807
F6-08 (036A)	Comm Parameter Reset @Initialize	V/f CL-V/f OLV CLV AOLV OLV/PM AOLV/PM CLV/PM EZOLV Sets the function to initialize F6-xx and F7-xx parameters when the drive is initialized with A1-03 [Initialize Parameters]. 0 : No Reset - Parameters Retained 1 : Reset Back to Factory Default	0 (0, 1)	807
F6-10 (03B6)	CC-Link Node Address	V/f CL-V/f OLV CLV AOLV OLV/PM AOLV/PM CLV/PM EZOLV Sets the node address for CC-Link communication. Restart the drive after you change the parameter setting. Note: Be sure to set a node address that is different than all other node addresses. Do not set this parameter to 0. Incorrect parameter settings will cause AEr [Station Address Setting Error] errors and the L.ERR LED on the option will come on.	0 (0 - 64)	807
F6-11 (03B7)	CC-Link Communication Speed	V/f CL-V/f OLV CLV AOLV OLV/PM AOLV/PM CLV/PM EZOLV Sets the communication speed for CC-Link communication. Restart the drive after you change the parameter setting. 0 : 156 kbps 1 : 625 kbps 2 : 2.5 Mbps 3 : 5 Mbps 4 : 10 Mbps	0 (0 - 4)	807
F6-14 (03BB)	BUS Error Auto Reset	V/f CL-V/f OLV CLV AOLV OLV/PM AOLV/PM CLV/PM EZOLV Sets the automatic reset function for bUS [Option Communication Errors]. 0 : Disabled 1 : Enabled	0 (0, 1)	808
F6-15 (0B5B)	Comm. Option Parameters Reload	V/f CL-V/f OLV CLV AOLV OLV/PM AOLV/PM CLV/PM EZOLV Sets the update method when you change F6-xx, F7-xx [Communication Options]. 0 : Reload at Next Power Cycle 1 : Reload Now 2 : Cancel Reload Request	0 (0 - 2)	808
F6-16 (0B8A)	Gateway Mode	V/f CL-V/f OLV CLV AOLV OLV/PM AOLV/PM CLV/PM EZOLV Sets the gateway mode operation and the number of connected slave drives. 0 : Disabled 1 : Enabled: 1 Slave Drives 2 : Enabled: 2 Slave Drives 3 : Enabled: 3 Slave Drives 4 : Enabled: 4 Slave Drives	0 (0 to 4)	808
F6-20 (036B)	MECHATROLINK Station Address	V/f CL-V/f OLV CLV AOLV OLV/PM AOLV/PM CLV/PM EZOLV Sets the station address for MECHATROLINK communication. Restart the drive after you change the parameter setting. Note: • The setting range changes if using MECHATROLINK-II or MECHATROLINK-III: –MECHATROLINK-II (SI-T3) range: 20 - 3F –MECHATROLINK-III (SI-ET3) range: 03 - EF • Be sure to set a node address that is different than all other node addresses. Incorrect parameter settings will cause AEr [Station Address Setting Error] errors and the L.ERR LED on the option will come on. • When the station address is 20 or 3F, the drive detects AEr errors.	0021h (MECHATROLINK-II: 0020h - 003Fh, MECHATROLINK-III: 0003h - 00EFh)	808
F6-21 (036C)	MECHATROLINK Frame Size	V/f CL-V/f OLV CLV AOLV OLV/PM AOLV/PM CLV/PM EZOLV Sets the frame size for MECHATROLINK communication. Restart the drive after you change the parameter setting. 0 : 32byte (M-2) / 64byte (M-3) 1 : 17byte (M-2) / 32byte (M-3)	0 (0, 1)	809
F6-22 (036D)	MECHATROLINK Link Speed	V/f CL-V/f OLV CLV AOLV OLV/PM AOLV/PM CLV/PM EZOLV Sets the communications speed for MECHATROLINK-II. Restart the drive after you change the parameter setting. Note: This parameter is only available with the MECHATROLINK-II option. 0 : 10 Mbps 1 : 4 Mbps	0 (0, 1)	809

11.9 F: Options

No. (Hex.)	Name	Description	Default (Range)	Ref.
F6-23 (036E)	MECHATROLINK Monitor Select (E)	<p>V/f CL-V/f OLV CLV AOLV OLV/PM AOLV/PM CLV/PM EZOLV</p> <p>Sets the MEMOBUS register used for the monitor functions of INV_CTL (drive operation control command) and INV_I/O (drive I/O control command). Restart the drive after you change the parameter setting.</p>	0000h (0000h - FFFFh)	809
F6-24 (036F)	MECHATROLINK Monitor Select (F)	<p>V/f CL-V/f OLV CLV AOLV OLV/PM AOLV/PM CLV/PM EZOLV</p> <p>Sets the MEMOBUS register used for the monitor functions of INV_CTL (drive operation control command) and INV_I/O (drive I/O control command). Restart the drive after you change the parameter setting.</p>	0000h (0000h - FFFFh)	809
F6-25 (03C9)	MECHATROLINK Watchdog Error Sel	<p>V/f CL-V/f OLV CLV AOLV OLV/PM AOLV/PM CLV/PM EZOLV</p> <p>Sets the method to stop the motor or let the motor continue operating when the drive detects an E5 [MECHATROLINK Watchdog Timer Err].</p> <p>0 : Ramp to Stop 1 : Coast to Stop 2 : Fast Stop (Use C1-09) 3 : Alarm Only</p>	1 (0 - 3)	809
F6-26 (03CA)	MECHATROLINK Allowable No of Err	<p>V/f CL-V/f OLV CLV AOLV OLV/PM AOLV/PM CLV/PM EZOLV</p> <p>Sets the number of times that the option must detect a bUS alarm to cause a bUS [Option Communication Error].</p>	2 (2 - 10 times)	810
F6-30 (03CB)	PROFIBUS-DP Node Address	<p>V/f CL-V/f OLV CLV AOLV OLV/PM AOLV/PM CLV/PM EZOLV</p> <p>Sets the node address for PROFIBUS-DP communication. Restart the drive after you change the parameter setting.</p> <p>Note: Be sure to set an address that is different than all other node addresses. Do not set this parameter to 0.</p>	0 (0 - 125)	810
F6-31 (03CC)	PROFIBUS-DP Clear Mode Selection	<p>V/f CL-V/f OLV CLV AOLV OLV/PM AOLV/PM CLV/PM EZOLV</p> <p>Sets what the drive will do after it receives the Clear Mode command.</p> <p>0 : Reset 1 : Hold Previous State</p>	0 (0, 1)	810
F6-32 (03CD)	PROFIBUS-DP Data Format Select	<p>V/f CL-V/f OLV CLV AOLV OLV/PM AOLV/PM CLV/PM EZOLV</p> <p>Sets the data format of PROFIBUS-DP communication. Restart the drive after you change the parameter setting.</p> <p>0 : PPO Type 1 : Conventional 2 : PPO (bit0) 3 : PPO (Enter) 4 : Conventional (Enter) 5 : PPO (bit0, Enter)</p>	0 (0 - 5)	810
F6-35 (03D0)	CANopen Node ID Selection	<p>V/f CL-V/f OLV CLV AOLV OLV/PM AOLV/PM CLV/PM EZOLV</p> <p>Sets the node address for CANopen communication. Restart the drive after you change the parameter setting.</p> <p>Note: Be sure to set an address that is different than all other node addresses. Do not set this parameter to 0. Incorrect parameter settings will cause AEr [Station Address Setting Error] errors and the L.ERR LED on the option will come on.</p>	0 (0 - 126)	811
F6-36 (03D1)	CANopen Communication Speed	<p>V/f CL-V/f OLV CLV AOLV OLV/PM AOLV/PM CLV/PM EZOLV</p> <p>Sets the CANopen communications speed. Restart the drive after you change the parameter setting.</p> <p>0 : Detect Automatically 1 : 10 kbps 2 : 20 kbps 3 : 50 kbps 4 : 125 kbps 5 : 250 kbps 6 : 500 kbps 7 : 800 kbps 8 : 1 Mbps</p>	6 (0 - 8)	811
F6-45 (02FB)	BACnet Node Address	<p>V/f CL-V/f OLV CLV AOLV OLV/PM AOLV/PM CLV/PM EZOLV</p> <p>Sets the node address for BACnet communication.</p> <p>Note: Be sure to set an address that is different than all other node addresses. Do not set this parameter to 0.</p>	1 (0 - 127)	811

No. (Hex.)	Name	Description	Default (Range)	Ref.
F6-46 (02FC)	BACnet Baud Rate	V/f CL-V/f OLV CLV AOLV OLV/PM AOLV/PM CLV/PM EZOLV Sets the BACnet communications speed. 0 : 1200 bps 1 : 2400 bps 2 : 4800 bps 3 : 9600 bps 4 : 19.2 kbps 5 : 38.4 kbps 6 : 57.6 kbps 7 : 76.8 kbps 8 : 115.2 kbps	3 (0 - 8)	811
F6-47 (02FD)	Rx to Tx Wait Time	V/f CL-V/f OLV CLV AOLV OLV/PM AOLV/PM CLV/PM EZOLV Sets the wait time for the drive to receive and send BACnet communication.	5 ms (5 - 65 ms)	812
F6-48 (02FE)	BACnet Device Object Identifier0	V/f CL-V/f OLV CLV AOLV OLV/PM AOLV/PM CLV/PM EZOLV Sets the last word of BACnet communication addresses.	0 (0 - FFFF)	812
F6-49 (02FF)	BACnet Device Object Identifier1	V/f CL-V/f OLV CLV AOLV OLV/PM AOLV/PM CLV/PM EZOLV Sets the last word of BACnet communication addresses.	0 (0 - 3F)	812
F6-50 (03C1)	DeviceNet MAC Address	V/f CL-V/f OLV CLV AOLV OLV/PM AOLV/PM CLV/PM EZOLV Sets the MAC address for DeviceNet communication. Restart the drive after you change the parameter setting. Note: Be sure to set a MAC address that is different than all other node addresses. Do not set this parameter to 0. Incorrect parameter settings will cause <i>AEr [Station Address Setting Error]</i> errors and the MS LED on the option will flash.	64 (0 - 64)	812
F6-51 (03C2)	DeviceNet Baud Rate	V/f CL-V/f OLV CLV AOLV OLV/PM AOLV/PM CLV/PM EZOLV Sets the DeviceNet communications speed. Restart the drive after you change the parameter setting. 0 : 125 kbps 1 : 250 kbps 2 : 500 kbps 3 : Adjustable from Network 4 : Detect Automatically	4 (0 - 4)	812
F6-52 (03C3)	DeviceNet PCA Setting	V/f CL-V/f OLV CLV AOLV OLV/PM AOLV/PM CLV/PM EZOLV Sets the format of data that the DeviceNet communication master sends to the drive.	21 (0 - 255)	812
F6-53 (03C4)	DeviceNet PPA Setting	V/f CL-V/f OLV CLV AOLV OLV/PM AOLV/PM CLV/PM EZOLV Sets the format of data that the drive sends to the DeviceNet communication master.	71 (0 - 255)	813
F6-54 (03C5)	DeviceNet Idle Fault Detection	V/f CL-V/f OLV CLV AOLV OLV/PM AOLV/PM CLV/PM EZOLV Sets the function to detect <i>EF0 [Option Card External Fault]</i> when the drive does not receive data from the DeviceNet master. 0 : Enabled 1 : Disabled, No Fault Detection 2 : Vendor Specific 3 : RUN Forward 4 : Reverse run	0 (0 - 4)	813
F6-55 (03C6)	DeviceNet Baud Rate Monitor	V/f CL-V/f OLV CLV AOLV OLV/PM AOLV/PM CLV/PM EZOLV Sets the function to see the actual DeviceNet communications speed using the keypad. This parameter functions as a monitor only. 0 : 125 kbps 1 : 250 kbps 2 : 500 kbps	0 (0 - 2)	813
F6-56 (03D7)	DeviceNet Speed Scaling	V/f CL-V/f OLV CLV AOLV OLV/PM AOLV/PM CLV/PM EZOLV Sets the speed scale for DeviceNet communication.	0 (-15 - +15)	813
F6-57 (03D8)	DeviceNet Current Scaling	V/f CL-V/f OLV CLV AOLV OLV/PM AOLV/PM CLV/PM EZOLV Sets the current scale of the DeviceNet communication master.	0 (-15 - +15)	813
F6-58 (03D9)	DeviceNet Torque Scaling	V/f CL-V/f OLV CLV AOLV OLV/PM AOLV/PM CLV/PM EZOLV Sets the torque scale of the DeviceNet communication master.	0 (-15 - +15)	813
F6-59 (03DA)	DeviceNet Power Scaling	V/f CL-V/f OLV CLV AOLV OLV/PM AOLV/PM CLV/PM EZOLV Sets the power scale of the DeviceNet communication master.	0 (-15 - +15)	814
F6-60 (03DB)	DeviceNet Voltage Scaling	V/f CL-V/f OLV CLV AOLV OLV/PM AOLV/PM CLV/PM EZOLV Sets the voltage scale of the DeviceNet communication master.	0 (-15 - +15)	814

11.9 F: Options

No. (Hex.)	Name	Description	Default (Range)	Ref.
F6-61 (03DC)	DeviceNet Time Scaling	V/f CL-V/f OLV CLV AOLV OLV/PM AOLV/PM CLV/PM EZOLV Sets the time scale of the DeviceNet communication master.	0 (-15 - +15)	814
F6-62 (03DD)	DeviceNet Heartbeat Interval	V/f CL-V/f OLV CLV AOLV OLV/PM AOLV/PM CLV/PM EZOLV Sets the heartbeat for DeviceNet communication. Set this parameter to 0 to disable the heartbeat function.	0 (0 - 10)	814
F6-63 (03DE)	DeviceNet Network MAC ID	V/f CL-V/f OLV CLV AOLV OLV/PM AOLV/PM CLV/PM EZOLV Sets the function to see the actual DeviceNet MAC address using the keypad. This parameter functions as a monitor only.	63 (0 - 63)	814
F6-64 to F6-67 (03DF - 03E2)	Dynamic Out Assembly 109 Param 1 to 4	V/f CL-V/f OLV CLV AOLV OLV/PM AOLV/PM CLV/PM EZOLV Sets Configurable Outputs 1 to 4 written to the MEMOBUS register.	0000h (0000h - FFFFh)	814
F6-68 to F6-71 (03E3, 03E4, 03C7, and 03C8)	Dynamic In Assembly 159 Param 1 to 4	V/f CL-V/f OLV CLV AOLV OLV/PM AOLV/PM CLV/PM EZOLV Sets Configurable Inputs 1 to 4 written to the MEMOBUS register.	0000h (0000h - FFFFh)	814
F6-72 (081B)	PowerLink Node Address	V/f CL-V/f OLV CLV AOLV OLV/PM AOLV/PM CLV/PM EZOLV Sets the node ID for PowerLink communication. Note: Be sure to set an address that is different than all other node addresses. Do not set this parameter to 0.	0 (0 - 255)	814

◆ F7: Ethernet Options

No. (Hex.)	Name	Description	Default (Range)	Ref.
F7-01 (03E5)	IP Address 1	V/f CL-V/f OLV CLV AOLV OLV/PM AOLV/PM CLV/PM EZOLV Sets the first octet of the IP Address for the device that is connecting to the network. Restart the drive after you change this parameter. Note: When F7-13 = 0 [Address Mode at Startup = Static]: • Use parameters F7-01 to F7-04 [IP Address 4] to set the IP Address. Be sure to set a different IP address for each drive on the network. • Also set parameters F7-01 to F7-12.	192 (0 - 255)	815
F7-02 (03E6)	IP Address 2	V/f CL-V/f OLV CLV AOLV OLV/PM AOLV/PM CLV/PM EZOLV Sets the second octet of the IP Address for the device that is connecting to the network. Restart the drive after you change this parameter. Note: When F7-13 = 0 [Address Mode at Startup = Static]: • Use parameters F7-01 to F7-04 [IP Address 4] to set the IP Address. Be sure to set a different IP address for each drive on the network. • Also set parameters F7-01 to F7-12.	168 (0 - 255)	815
F7-03 (03E7)	IP Address 3	V/f CL-V/f OLV CLV AOLV OLV/PM AOLV/PM CLV/PM EZOLV Sets the third octet of the IP Address for the device that is connecting to the network. Restart the drive after you change this parameter. Note: When F7-13 = 0 [Address Mode at Startup = Static]: • Use parameters F7-01 to F7-04 [IP Address 4] to set the IP Address. Be sure to set a different IP address for each drive on the network. • Also set parameters F7-01 to F7-12.	1 (0 - 255)	815
F7-04 (03E8)	IP Address 4	V/f CL-V/f OLV CLV AOLV OLV/PM AOLV/PM CLV/PM EZOLV Sets the fourth octet of the IP Address for the device that is connecting to the network. Restart the drive after you change this parameter. Note: When F7-13 = 0 [Address Mode at Startup = Static]: • Use parameters F7-01 to F7-04 [IP Address 4] to set the IP Address. Be sure to set a different IP address for each drive on the network. • Also set parameters F7-01 to F7-12.	20 (0 - 255)	815
F7-05 (03E9)	Subnet Mask 1	V/f CL-V/f OLV CLV AOLV OLV/PM AOLV/PM CLV/PM EZOLV Sets the first octet of the subnet mask of the connected network. Note: Set this parameter when F7-13 = 0 [Address Mode at Startup = Static].	255 (0 - 255)	815
F7-06 (03EA)	Subnet Mask 2	V/f CL-V/f OLV CLV AOLV OLV/PM AOLV/PM CLV/PM EZOLV Sets the second octet of the subnet mask of the connected network. Note: Set this parameter when F7-13 = 0 [Address Mode at Startup = Static].	255 (0 - 255)	816

No. (Hex.)	Name	Description	Default (Range)	Ref.
F7-07 (03EB)	Subnet Mask 3	V/f CL-V/f OLV CLV AOLV OLV/PM AOLV/PM CLV/PM EZOLV Sets the third octet of the subnet mask of the connected network. Note: Set this parameter when $F7-13 = 0$ [Address Mode at Startup = Static].	255 (0 - 255)	816
F7-08 (03EC)	Subnet Mask 4	V/f CL-V/f OLV CLV AOLV OLV/PM AOLV/PM CLV/PM EZOLV Sets the fourth octet of the subnet mask of the connected network. Note: Set this parameter when $F7-13 = 0$ [Address Mode at Startup = Static].	0 (0 - 255)	816
F7-09 (03ED)	Gateway Address 1	V/f CL-V/f OLV CLV AOLV OLV/PM AOLV/PM CLV/PM EZOLV Sets the first octet of the gateway address of the connected network. Note: Set this parameter when $F7-13 = 0$ [Address Mode at Startup = Static].	192 (0 - 255)	816
F7-10 (03EE)	Gateway Address 2	V/f CL-V/f OLV CLV AOLV OLV/PM AOLV/PM CLV/PM EZOLV Sets the second octet of the gateway address of the connected network. Note: Set this parameter when $F7-13 = 0$ [Address Mode at Startup = Static].	168 (0 - 255)	816
F7-11 (03EF)	Gateway Address 3	V/f CL-V/f OLV CLV AOLV OLV/PM AOLV/PM CLV/PM EZOLV Sets the third octet of the gateway address of the connected network. Note: Set this parameter when $F7-13 = 0$ [Address Mode at Startup = Static].	1 (0 - 255)	816
F7-12 (03F0)	Gateway Address 4	V/f CL-V/f OLV CLV AOLV OLV/PM AOLV/PM CLV/PM EZOLV Sets the fourth octet of the gateway address of the connected network. Note: Set this parameter when $F7-13 = 0$ [Address Mode at Startup = Static].	1 (0 - 255)	817
F7-13 (03F1)	Address Mode at Startup	V/f CL-V/f OLV CLV AOLV OLV/PM AOLV/PM CLV/PM EZOLV Sets the method to set option card IP addresses. 0 : Static 1 : BOOTP 2 : DHCP Note: • The following setting values are available when using the PROFINET communication option card (SI-EP3). –0: Static –2: DHCP • When $F7-13 = 0$, set parameters $F7-01$ to $F7-12$ [IP Address 1 to Gateway Address 4] to set the IP Address. Be sure to set a different IP address for each drive on the network.	2 (0 - 2)	817
F7-14 (03F2)	Duplex Mode Selection	V/f CL-V/f OLV CLV AOLV OLV/PM AOLV/PM CLV/PM EZOLV Sets the duplex mode setting method. 0 : Half/Half 1 : Auto/Auto 2 : Full/Full 3 : Half/Auto 4 : Half/Full 5 : Auto/Half 6 : Auto/Full 7 : Full/Half 8 : Full/Auto	1 (0 - 8)	817
F7-15 (03F3)	Communication Speed Selection	V/f CL-V/f OLV CLV AOLV OLV/PM AOLV/PM CLV/PM EZOLV Sets the communications speed. 10 : 10/10 Mbps 100 : 100/100 Mbps 101 : 10/100 Mbps 102 : 100/10 Mbps	10 (10, 100 - 102)	817
F7-16 (03F4)	Timeout Value	V/f CL-V/f OLV CLV AOLV OLV/PM AOLV/PM CLV/PM EZOLV Sets the detection time for a communications timeout. Note: Set this parameter to 0.0 to disable the connection timeout function.	0.0 s (0.0 - 30.0 s)	818
F7-17 (03F5)	EtherNet/IP Speed Scaling Factor	V/f CL-V/f OLV CLV AOLV OLV/PM AOLV/PM CLV/PM EZOLV Sets the scaling factor for the speed monitor in the EtherNet/IP Class ID 2AH Object.	0 (-15 - +15)	818

11.9 F: Options

No. (Hex.)	Name	Description	Default (Range)	Ref.
F7-18 (03F6)	EtherNet/IP Current Scale Factor	V/f CL-V/f OLV CLV AOLV OLV/PM AOLV/PM CLV/PM EZOLV Sets the scaling factor for the output current monitor in the EtherNet/IP Class ID 2AH Object.	0 (-15 - +15)	818
F7-19 (03F7)	EtherNet/IP Torque Scale Factor	V/f CL-V/f OLV CLV AOLV OLV/PM AOLV/PM CLV/PM EZOLV Sets the scaling factor for the torque monitor in the EtherNet/IP Class ID 2AH Object.	0 (-15 - +15)	818
F7-20 (03F8)	EtherNet/IP Power Scaling Factor	V/f CL-V/f OLV CLV AOLV OLV/PM AOLV/PM CLV/PM EZOLV Sets the scaling factor for the power monitor in the EtherNet/IP Class ID 2AH Object.	0 (-15 - +15)	818
F7-21 (03F9)	EtherNet/IP Voltage Scale Factor	V/f CL-V/f OLV CLV AOLV OLV/PM AOLV/PM CLV/PM EZOLV Sets the scaling factor for the voltage monitor in the EtherNet/IP Class ID 2AH Object.	0 (-15 - +15)	818
F7-22 (03FA)	EtherNet/IP Time Scaling	V/f CL-V/f OLV CLV AOLV OLV/PM AOLV/PM CLV/PM EZOLV Sets the scaling factor for the time monitor in the EtherNet/IP Class ID 2AH Object.	0 (-15 - +15)	818
F7-23 - F7-27 (03FB - 03FF) F7-28- F7-32 (0370 - 0374)	Dynamic Out Param 1 to 10 for CommCard	V/f CL-V/f OLV CLV AOLV OLV/PM AOLV/PM CLV/PM EZOLV Sets Output Assembly 116. The drive writes the values from Output Assembly 116 to the MEMOBUS/Modbus address register that is stored for each parameter. The drive will not write the values from Output Assembly 116 to the registers when the MEMOBUS/Modbus address is 0.	0	819
F7-33 - F7-42 (0375 - 037E)	Dynamic In Param 1 to 10 for CommCard	V/f CL-V/f OLV CLV AOLV OLV/PM AOLV/PM CLV/PM EZOLV Sets Input Assembly 166. The drive sends the values from the MEMOBUS/Modbus address registers stored for each parameter to Input Assembly 166. The drive returns the default register value for the option card when the MEMOBUS/Modbus address is 0 and the value sent to Input Assembly 166 is not defined.	0	819
F7-60 (0780)	PZD1 Write (Control Word)	V/f CL-V/f OLV CLV AOLV OLV/PM AOLV/PM CLV/PM EZOLV Sets the MEMOBUS/Modbus address for PZD1 (PPO output). PZD1 (PPO output) functions as the STW when $F7-60 = 0, 1, \text{ or } 2$.	0	819
F7-61 (0781)	PZD2 Write (Frequency Reference)	V/f CL-V/f OLV CLV AOLV OLV/PM AOLV/PM CLV/PM EZOLV Sets the MEMOBUS/Modbus address for PZD2 (PPO output). PZD2 (PPO output) functions as the HSW when $F7-61 = 0, 1, \text{ or } 2$.	0	819
F7-62 (0782)	PZD3 Write	V/f CL-V/f OLV CLV AOLV OLV/PM AOLV/PM CLV/PM EZOLV Sets the MEMOBUS/Modbus address for PZD3 (PPO output). A value of 0, 1, or 2 will disable the PZD3 (PPO output) write operation to the MEMOBUS/Modbus register.	0	819
F7-63 (0783)	PZD4 Write	V/f CL-V/f OLV CLV AOLV OLV/PM AOLV/PM CLV/PM EZOLV Sets the MEMOBUS/Modbus address for PZD4 (PPO output). A value of 0, 1, or 2 will disable the PZD4 (PPO output) write operation to the MEMOBUS/Modbus register.	0	819
F7-64 (0784)	PZD5 Write	V/f CL-V/f OLV CLV AOLV OLV/PM AOLV/PM CLV/PM EZOLV Sets the MEMOBUS/Modbus address for PZD5 (PPO output). A value of 0, 1, or 2 will disable the PZD5 (PPO output) write operation to the MEMOBUS/Modbus register.	0	819
F7-65 (0785)	PZD6 Write	V/f CL-V/f OLV CLV AOLV OLV/PM AOLV/PM CLV/PM EZOLV Sets the MEMOBUS/Modbus address for PZD6 (PPO output). A value of 0, 1, or 2 will disable the PZD6 (PPO output) write operation to the MEMOBUS/Modbus register.	0	820
F7-66 (0786)	PZD7 Write	V/f CL-V/f OLV CLV AOLV OLV/PM AOLV/PM CLV/PM EZOLV Sets the MEMOBUS/Modbus address for PZD7 (PPO output). A value of 0, 1, or 2 will disable the PZD7 (PPO output) write operation to the MEMOBUS/Modbus register.	0	820
F7-67 (0787)	PZD8 Write	V/f CL-V/f OLV CLV AOLV OLV/PM AOLV/PM CLV/PM EZOLV Sets the MEMOBUS/Modbus address for PZD8 (PPO output). A value of 0, 1, or 2 will disable the PZD8 (PPO output) write operation to the MEMOBUS/Modbus register.	0	820
F7-68 (0788)	PZD9 Write	V/f CL-V/f OLV CLV AOLV OLV/PM AOLV/PM CLV/PM EZOLV Sets the MEMOBUS/Modbus address for PZD9 (PPO output). A value of 0, 1, or 2 will disable the PZD9 (PPO output) write operation to the MEMOBUS/Modbus register.	0	820
F7-69 (0789)	PZD10 Write	V/f CL-V/f OLV CLV AOLV OLV/PM AOLV/PM CLV/PM EZOLV Sets the MEMOBUS/Modbus address for PZD10 (PPO output). A value of 0, 1, or 2 will disable the PZD10 (PPO output) write operation to the MEMOBUS/Modbus register.	0	820
F7-70 (078A)	PZD1 Read (Status Word)	V/f CL-V/f OLV CLV AOLV OLV/PM AOLV/PM CLV/PM EZOLV Sets the MEMOBUS/Modbus address for PZD1 (PPO Read). PZD1 (PPO input) functions as the ZSW when $F7-70 = 0$.	0	820
F7-71 (078B)	PZD2 Read (Output Frequency)	V/f CL-V/f OLV CLV AOLV OLV/PM AOLV/PM CLV/PM EZOLV Sets the MEMOBUS/Modbus address for PZD2 (PPO Read). PZD2 (PPO input) functions as the HIW when $F7-71 = 0$.	0	820
F7-72 (078C)	PZD3 Read	V/f CL-V/f OLV CLV AOLV OLV/PM AOLV/PM CLV/PM EZOLV Sets the MEMOBUS/Modbus address for PZD3 (PPO Read). A value of 0 will disable the PZD3 (PPO Read) load operation from the MEMOBUS/Modbus register.	0	820
F7-73 (078D)	PZD4 Read	V/f CL-V/f OLV CLV AOLV OLV/PM AOLV/PM CLV/PM EZOLV Sets the MEMOBUS/Modbus address for PZD4 (PPO Read). A value of 0 will disable the PZD4 (PPO Read) load operation from the MEMOBUS/Modbus register.	0	821

No. (Hex.)	Name	Description	Default (Range)	Ref.
F7-74 (078E)	PZD5 Read	V/f CL-V/f OLV CLV AOLV OLV/PM AOLV/PM CLV/PM EZOLV Sets the MEMOBUS/Modbus address for PZD5 (PPO Read). A value of 0 will disable the PZD5 (PPO Read) load operation from the MEMOBUS/Modbus register.	0	821
F7-75 (078F)	PZD6 Read	V/f CL-V/f OLV CLV AOLV OLV/PM AOLV/PM CLV/PM EZOLV Sets the MEMOBUS/Modbus address for PZD6 (PPO Read). A value of 0 will disable the PZD6 (PPO Read) load operation from the MEMOBUS/Modbus register.	0	821
F7-76 (0790)	PZD7 Read	V/f CL-V/f OLV CLV AOLV OLV/PM AOLV/PM CLV/PM EZOLV Sets the MEMOBUS/Modbus address for PZD7 (PPO Read). A value of 0 will disable the PZD7 (PPO input) load operation from the MEMOBUS/Modbus register.	0	821
F7-77 (0791)	PZD8 Read	V/f CL-V/f OLV CLV AOLV OLV/PM AOLV/PM CLV/PM EZOLV Sets the MEMOBUS/Modbus address for PZD8 (PPO Read). A value of 0 will disable the PZD8 (PPO Read) load operation from the MEMOBUS/Modbus register.	0	821
F7-78 (0792)	PZD9 Read	V/f CL-V/f OLV CLV AOLV OLV/PM AOLV/PM CLV/PM EZOLV Sets the MEMOBUS/Modbus address for PZD9 (PPO Read). A value of 0 will disable the PZD9 (PPO Read) load operation from the MEMOBUS/Modbus register.	0	821
F7-79 (0793)	PZD10 Read	V/f CL-V/f OLV CLV AOLV OLV/PM AOLV/PM CLV/PM EZOLV Sets the MEMOBUS/Modbus address for PZD10 (PPO Read). A value of 0 will disable the PZD10 (PPO Read) load operation from the MEMOBUS/Modbus register.	0	821

11.10 H: Terminal Functions

◆ H1: Digital Inputs

No. (Hex.)	Name	Description	Default (Range)	Ref.
H1-01 (0438)	Terminal S1 Function Selection	<p>V/f CL-V/f OLV CLV AOLV OLV/PM AOLV/PM CLV/PM EZOLV</p> <p>Sets the function for MFDI terminal S1.</p> <p>Note: The default setting is <i>F</i> when the drive is initialized for 3-Wire Initialization [A1-03 = 3330].</p>	40 (1 - 1FF)	823
H1-02 (0439)	Terminal S2 Function Selection	<p>V/f CL-V/f OLV CLV AOLV OLV/PM AOLV/PM CLV/PM EZOLV</p> <p>Sets the function for MFDI terminal S2.</p> <p>Note: The default setting is <i>F</i> when the drive is initialized for 3-Wire Initialization [A1-03 = 3330].</p>	41 (1 - 1FF)	823
H1-03 (0400)	Terminal S3 Function Selection	<p>V/f CL-V/f OLV CLV AOLV OLV/PM AOLV/PM CLV/PM EZOLV</p> <p>Sets the function for MFDI terminal S3.</p>	24 (0 - 1FF)	823
H1-04 (0401)	Terminal S4 Function Selection	<p>V/f CL-V/f OLV CLV AOLV OLV/PM AOLV/PM CLV/PM EZOLV</p> <p>Sets the function for MFDI terminal S4.</p>	14 (0 - 1FF)	823
H1-05 (0402)	Terminal S5 Function Selection	<p>V/f CL-V/f OLV CLV AOLV OLV/PM AOLV/PM CLV/PM EZOLV</p> <p>Sets the function for MFDI terminal S5.</p> <p>Note: The default setting is <i>0</i> when the drive is initialized for 3-Wire Initialization [A1-03 = 3330].</p>	3 (0 - 1FF)	823
H1-06 (0403)	Terminal S6 Function Selection	<p>V/f CL-V/f OLV CLV AOLV OLV/PM AOLV/PM CLV/PM EZOLV</p> <p>Sets the function for MFDI terminal S6.</p> <p>Note: When you initialize the drive for 3-Wire Initialization [A1-03 = 3330], the default setting is <i>3</i>.</p>	4 (0 - 1FF)	824
H1-07 (0404)	Terminal S7 Function Selection	<p>V/f CL-V/f OLV CLV AOLV OLV/PM AOLV/PM CLV/PM EZOLV</p> <p>Sets the function for MFDI terminal S7.</p> <p>Note: When you initialize the drive for 3-Wire Initialization [A1-03 = 3330], the default setting is <i>4</i>.</p>	6 (0 - 1FF)	824
H1-08 (0405)	Terminal S8 Function Selection	<p>V/f CL-V/f OLV CLV AOLV OLV/PM AOLV/PM CLV/PM EZOLV</p> <p>Sets the function for MFDI terminal S8.</p>	8 (0 - 1FF)	824
H1-21 (0B70)	Terminal S1 Function Selection 2	<p>V/f CL-V/f OLV CLV AOLV OLV/PM AOLV/PM CLV/PM EZOLV</p> <p>Sets the second function for MFDI terminal S1.</p>	F (1 - 19F)	824
H1-22 (0B71)	Terminal S2 Function Select 2	<p>V/f CL-V/f OLV CLV AOLV OLV/PM AOLV/PM CLV/PM EZOLV</p> <p>Sets the second function for MFDI terminal S2.</p>	F (1 - 19F)	824
H1-23 (0B72)	Terminal S3 Function Selection 2	<p>V/f CL-V/f OLV CLV AOLV OLV/PM AOLV/PM CLV/PM EZOLV</p> <p>Sets the second function for MFDI terminal S3.</p>	F (1 - 19F)	824
H1-24 (0B73)	Terminal S4 Function Selection 2	<p>V/f CL-V/f OLV CLV AOLV OLV/PM AOLV/PM CLV/PM EZOLV</p> <p>Sets the second function for MFDI terminal S4.</p>	F (1 - 19F)	825
H1-25 (0B74)	Terminal S5 Function Selection 2	<p>V/f CL-V/f OLV CLV AOLV OLV/PM AOLV/PM CLV/PM EZOLV</p> <p>Sets the second function for MFDI terminal S5.</p>	F (1 - 19F)	825
H1-26 (0B75)	Terminal S6 Function Selection 2	<p>V/f CL-V/f OLV CLV AOLV OLV/PM AOLV/PM CLV/PM EZOLV</p> <p>Sets the second function for MFDI terminal S6.</p>	F (1 - 19F)	825
H1-27 (0B76)	Terminal S7 Function Selection 2	<p>V/f CL-V/f OLV CLV AOLV OLV/PM AOLV/PM CLV/PM EZOLV</p> <p>Sets the second function for MFDI terminal S7.</p>	F (1 - 19F)	825
H1-28 (0B77)	Terminal S8 Function Selection 2	<p>V/f CL-V/f OLV CLV AOLV OLV/PM AOLV/PM CLV/PM EZOLV</p> <p>Sets the second function for MFDI terminal S8.</p>	F (1 - 19F)	825
H1-40 (0B54)	Mbus Reg 15C0h bit0 Input Func	<p>V/f CL-V/f OLV CLV AOLV OLV/PM AOLV/PM CLV/PM EZOLV</p> <p>Selects MFDI function assigned to <i>bit 0</i> of the MEMOBUS register 15C0 (Hex.).</p>	F (1 - 19F)	826
H1-41 (0B55)	Mbus Reg 15C0h bit1 Input Func	<p>V/f CL-V/f OLV CLV AOLV OLV/PM AOLV/PM CLV/PM EZOLV</p> <p>Selects MFDI function assigned to <i>bit 1</i> of the MEMOBUS register 15C0 (Hex.).</p>	F (1 - 19F)	826
H1-42 (0B56)	Mbus Reg 15C0h bit2 Input Func	<p>V/f CL-V/f OLV CLV AOLV OLV/PM AOLV/PM CLV/PM EZOLV</p> <p>Selects MFDI function assigned to <i>bit 2</i> of the MEMOBUS register 15C0 (Hex.).</p>	F (1 - 19F)	826

■ H1-xx: MFDI Setting Values

Setting Value	Function	Description	Ref.
0	3-Wire Sequence	<p><input type="checkbox"/> V/f <input type="checkbox"/> CL-V/f <input type="checkbox"/> OLV <input type="checkbox"/> CLV <input type="checkbox"/> AOLV <input type="checkbox"/> OLV/PM <input type="checkbox"/> AOLV/PM <input type="checkbox"/> CLV/PM <input type="checkbox"/> EZOLV</p> <p>Sets the direction of motor rotation for 3-wire sequence.</p>	826
1	LOCAL/REMOTE Selection	<p><input type="checkbox"/> V/f <input type="checkbox"/> CL-V/f <input type="checkbox"/> OLV <input type="checkbox"/> CLV <input type="checkbox"/> AOLV <input type="checkbox"/> OLV/PM <input type="checkbox"/> AOLV/PM <input type="checkbox"/> CLV/PM <input type="checkbox"/> EZOLV</p> <p>Sets drive control for the keypad (LOCAL) or an external source (REMOTE). ON : LOCAL OFF : REMOTE</p>	827
2	External Reference 1/2 Selection	<p><input type="checkbox"/> V/f <input type="checkbox"/> CL-V/f <input type="checkbox"/> OLV <input type="checkbox"/> CLV <input type="checkbox"/> AOLV <input type="checkbox"/> OLV/PM <input type="checkbox"/> AOLV/PM <input type="checkbox"/> CLV/PM <input type="checkbox"/> EZOLV</p> <p>Sets the drive to use Run command source 1/2 or Reference command source 1/2 when in REMOTE Mode. ON : b1-15 = [Frequency Reference Selection 2], b1-16 [Run Command Selection 2] OFF : b1-01 = [Frequency Reference Selection 1], b1-02 [Run Command Selection 1]</p>	827
3	Multi-Step Speed Reference 1	<p><input type="checkbox"/> V/f <input type="checkbox"/> CL-V/f <input type="checkbox"/> OLV <input type="checkbox"/> CLV <input type="checkbox"/> AOLV <input type="checkbox"/> OLV/PM <input type="checkbox"/> AOLV/PM <input type="checkbox"/> CLV/PM <input type="checkbox"/> EZOLV</p> <p>Uses speed references d1-01 to d1-16 to set a multi-step speed reference.</p>	827
4	Multi-Step Speed Reference 2	<p><input type="checkbox"/> V/f <input type="checkbox"/> CL-V/f <input type="checkbox"/> OLV <input type="checkbox"/> CLV <input type="checkbox"/> AOLV <input type="checkbox"/> OLV/PM <input type="checkbox"/> AOLV/PM <input type="checkbox"/> CLV/PM <input type="checkbox"/> EZOLV</p> <p>Uses speed references d1-01 to d1-16 to set a multi-step speed reference.</p>	828
5	Multi-Step Speed Reference 3	<p><input type="checkbox"/> V/f <input type="checkbox"/> CL-V/f <input type="checkbox"/> OLV <input type="checkbox"/> CLV <input type="checkbox"/> AOLV <input type="checkbox"/> OLV/PM <input type="checkbox"/> AOLV/PM <input type="checkbox"/> CLV/PM <input type="checkbox"/> EZOLV</p> <p>Uses speed references d1-01 to d1-16 to set a multi-step speed reference.</p>	828
6	Jog Reference Selection	<p><input type="checkbox"/> V/f <input type="checkbox"/> CL-V/f <input type="checkbox"/> OLV <input type="checkbox"/> CLV <input type="checkbox"/> AOLV <input type="checkbox"/> OLV/PM <input type="checkbox"/> AOLV/PM <input type="checkbox"/> CLV/PM <input type="checkbox"/> EZOLV</p> <p>Sets the drive to use the JOG Frequency Reference (JOG command) set in d1-17. The JOG Frequency Reference (JOG command) overrides Frequency References 1 to 16 (d1-01 to d1-16).</p>	828
7	Accel/Decel Time Selection 1	<p><input type="checkbox"/> V/f <input type="checkbox"/> CL-V/f <input type="checkbox"/> OLV <input type="checkbox"/> CLV <input type="checkbox"/> AOLV <input type="checkbox"/> OLV/PM <input type="checkbox"/> AOLV/PM <input type="checkbox"/> CLV/PM <input type="checkbox"/> EZOLV</p> <p>Sets the drive to use Acceleration/Deceleration Time 1 [C1-01, C1-02] or Acceleration/Deceleration Time 2 [C1-03, C1-04].</p>	828
8	Baseblock Command (N. O.)	<p><input type="checkbox"/> V/f <input type="checkbox"/> CL-V/f <input type="checkbox"/> OLV <input type="checkbox"/> CLV <input type="checkbox"/> AOLV <input type="checkbox"/> OLV/PM <input type="checkbox"/> AOLV/PM <input type="checkbox"/> CLV/PM <input type="checkbox"/> EZOLV</p> <p>Sets the command that stops drive output and coasts the motor to stop when the input is ON. ON : Baseblock (drive output stop) OFF : Normal operation</p>	828
9	Baseblock Command (N. C.)	<p><input type="checkbox"/> V/f <input type="checkbox"/> CL-V/f <input type="checkbox"/> OLV <input type="checkbox"/> CLV <input type="checkbox"/> AOLV <input type="checkbox"/> OLV/PM <input type="checkbox"/> AOLV/PM <input type="checkbox"/> CLV/PM <input type="checkbox"/> EZOLV</p> <p>Sets the command that stops drive output and coasts the motor to stop when the input terminal is OFF. ON : Normal operation OFF : Baseblock (drive output stop)</p>	829
A	Accel/Decel Ramp Hold	<p><input type="checkbox"/> V/f <input type="checkbox"/> CL-V/f <input type="checkbox"/> OLV <input type="checkbox"/> CLV <input type="checkbox"/> AOLV <input type="checkbox"/> OLV/PM <input type="checkbox"/> AOLV/PM <input type="checkbox"/> CLV/PM <input type="checkbox"/> EZOLV</p> <p>Momentarily pauses motor acceleration and deceleration when the terminal is turned ON, retains the output frequency that was stored in the drive at the time of the pause, and restarts motor operation.</p>	829
B	Overheat Alarm (oH2)	<p><input type="checkbox"/> V/f <input type="checkbox"/> CL-V/f <input type="checkbox"/> OLV <input type="checkbox"/> CLV <input type="checkbox"/> AOLV <input type="checkbox"/> OLV/PM <input type="checkbox"/> AOLV/PM <input type="checkbox"/> CLV/PM <input type="checkbox"/> EZOLV</p> <p>Sets the drive to display an oH2 [Drive Overheat Warning] alarm when the input terminal is ON. The alarm does not have an effect on drive operation.</p>	829
C	Analog Terminal Enable Selection	<p><input type="checkbox"/> V/f <input type="checkbox"/> CL-V/f <input type="checkbox"/> OLV <input type="checkbox"/> CLV <input type="checkbox"/> AOLV <input type="checkbox"/> OLV/PM <input type="checkbox"/> AOLV/PM <input type="checkbox"/> CLV/PM <input type="checkbox"/> EZOLV</p> <p>Sets the command that enables or disables the terminals selected in H3-14 [Analog Input Terminal Enable Sel]. ON : Input to the terminal selected with H3-14 is enabled OFF : Input to the terminal selected with H3-14 is disabled</p>	829
D	Ignore Speed Fdbk (V/f w/o Enc)	<p><input type="checkbox"/> V/f <input type="checkbox"/> CL-V/f <input type="checkbox"/> OLV <input type="checkbox"/> CLV <input type="checkbox"/> AOLV <input type="checkbox"/> OLV/PM <input type="checkbox"/> AOLV/PM <input type="checkbox"/> CLV/PM <input type="checkbox"/> EZOLV</p> <p>Sets the command to disable speed feedback control and run the drive in V/f control or use speed feedback from the encoder. ON : Speed feedback control disable (V/f Control) OFF : Speed feedback control enable (Closed Loop V/f Control)</p>	829
E	ASR Integral Reset	<p><input type="checkbox"/> V/f <input type="checkbox"/> CL-V/f <input type="checkbox"/> OLV <input type="checkbox"/> CLV <input type="checkbox"/> AOLV <input type="checkbox"/> OLV/PM <input type="checkbox"/> AOLV/PM <input type="checkbox"/> CLV/PM <input type="checkbox"/> EZOLV</p> <p>Sets the command to reset the integral value and use PI control or P control for the speed control loop. ON : P control OFF : PI control</p>	829
F	Not Used	<p><input type="checkbox"/> V/f <input type="checkbox"/> CL-V/f <input type="checkbox"/> OLV <input type="checkbox"/> CLV <input type="checkbox"/> AOLV <input type="checkbox"/> OLV/PM <input type="checkbox"/> AOLV/PM <input type="checkbox"/> CLV/PM <input type="checkbox"/> EZOLV</p> <p>Use this setting for unused terminals or to use terminals in through mode.</p>	830
10	Up Command	<p><input type="checkbox"/> V/f <input type="checkbox"/> CL-V/f <input type="checkbox"/> OLV <input type="checkbox"/> CLV <input type="checkbox"/> AOLV <input type="checkbox"/> OLV/PM <input type="checkbox"/> AOLV/PM <input type="checkbox"/> CLV/PM <input type="checkbox"/> EZOLV</p> <p>Sets the command to use a push button switch to increase the drive frequency reference. You must also set Setting 11 [Down Command]. ON : Increases the frequency reference. OFF : Holds the current frequency reference.</p>	830

11.10 H: Terminal Functions

Setting Value	Function	Description	Ref.
11	Down Command	<p>V/f CL-V/f OLV CLV AOLV OLV/PM AOLV/PM CLV/PM EZOLV</p> <p>Sets the command to use a push button switch to decrease the drive frequency reference. You must also set <i>Setting 10 [Up Command]</i>. ON : Decreases the frequency reference. OFF : Holds the current frequency reference.</p>	831
12	Forward Jog	<p>V/f CL-V/f OLV CLV AOLV OLV/PM AOLV/PM CLV/PM EZOLV</p> <p>Sets the command to operate the motor in the forward direction at the Jog Frequency set in <i>d1-17 [Jog Reference]</i>.</p>	832
13	Reverse Jog	<p>V/f CL-V/f OLV CLV AOLV OLV/PM AOLV/PM CLV/PM EZOLV</p> <p>Sets the command to operate the motor in reverse at the Jog Frequency set in <i>d1-17 [Jog Reference]</i>.</p>	832
14	Fault Reset Procedure	<p>V/f CL-V/f OLV CLV AOLV OLV/PM AOLV/PM CLV/PM EZOLV</p> <p>Sets the command to reset the current fault when the Run command is inactive. Note: The drive ignores the fault reset command when the Run command is active. Remove the Run command before trying to reset a fault.</p>	833
15	Fast Stop (N.O.)	<p>V/f CL-V/f OLV CLV AOLV OLV/PM AOLV/PM CLV/PM EZOLV</p> <p>Sets the command to ramp to stop in the deceleration time set in <i>C1-09 [Fast Stop Time]</i> when the input terminal is activated while the drive is operating.</p>	833
16	Motor 2 Selection	<p>V/f CL-V/f OLV CLV AOLV OLV/PM AOLV/PM CLV/PM EZOLV</p> <p>Sets the command for the drive to operate motor 1 or motor 2. Stop the motors before switching. ON : Operate motor 2 OFF : Operate motor 1</p>	833
17	Fast Stop (N.C.)	<p>V/f CL-V/f OLV CLV AOLV OLV/PM AOLV/PM CLV/PM EZOLV</p> <p>Sets the command to ramp to stop in the deceleration time set in <i>C1-09 [Fast Stop Time]</i> when the input terminal is activated while the drive is operating.</p>	834
18	Timer Function	<p>V/f CL-V/f OLV CLV AOLV OLV/PM AOLV/PM CLV/PM EZOLV</p> <p>Sets the command to start the timer function. Use this setting with <i>Timer Output [H2-xx = 12]</i>.</p>	834
19	PID Disable	<p>V/f CL-V/f OLV CLV AOLV OLV/PM AOLV/PM CLV/PM EZOLV</p> <p>Sets the command to disable PID control when <i>b5-01 = 1 to 8 [PID Mode Setting = Enabled]</i>. ON : PID control disabled OFF : PID control enabled</p>	835
1A	Accel/Decel Time Selection 2	<p>V/f CL-V/f OLV CLV AOLV OLV/PM AOLV/PM CLV/PM EZOLV</p> <p>Set this function and <i>H1-xx = 7 [Accel/Decel Time Selection 1]</i> together. Sets the drive to use <i>Acceleration/Deceleration Time 3 [C1-05, C1-06]</i> or <i>Acceleration/Deceleration Time 4 [C1-07, C1-08]</i>.</p>	835
1B	Programming Lockout	<p>V/f CL-V/f OLV CLV AOLV OLV/PM AOLV/PM CLV/PM EZOLV</p> <p>Sets the command to prevent parameter changes when the terminal is OFF. ON : Programming Lockout OFF : Parameter Write Prohibit</p>	835
1E	Reference Sample Hold	<p>V/f CL-V/f OLV CLV AOLV OLV/PM AOLV/PM CLV/PM EZOLV</p> <p>Sets the command to sample the frequency reference at terminals A1, A2, or A3 and hold the frequency reference at that frequency.</p>	835
20 to 2F	External fault	<p>V/f CL-V/f OLV CLV AOLV OLV/PM AOLV/PM CLV/PM EZOLV</p> <p>Sets a command to stop the drive when a failure or fault occurs on an external device. 20 : External Fault (NO-Always-Ramp) 21 : External Fault (NC-Always-Ramp) 22 : External Fault (NO-@Run-Ramp) 23 : External Fault (NC-@Run-Ramp) 24 : External Fault (NO-Always-Coast) 25 : External Fault (NC-Always-Coast) 26 : External Fault (NO-@Run-Coast) 27 : External Fault (NC-@Run-Coast) 28 : External Fault (NO-Always-FStop) 29 : External Fault (NC-Always-FStop) 2A : External Fault (NO-@Run-FStop) 2B : External Fault (NC-@Run-FStop) 2C : External Fault (NO-Always-Alarm) 2D : External Fault (NC-Always-Alarm) 2E : External Fault (NO-@Run-Alarm) 2F : External Fault (NC-@Run-Alarm)</p>	836
30	PID Integrator Reset	<p>V/f CL-V/f OLV CLV AOLV OLV/PM AOLV/PM CLV/PM EZOLV</p> <p>Sets the command to reset and hold the PID control integral to 0 when the terminal is ON.</p>	836
31	PID Integrator Hold	<p>V/f CL-V/f OLV CLV AOLV OLV/PM AOLV/PM CLV/PM EZOLV</p> <p>Sets the command to hold the integral value of the PID control while the terminal is activated.</p>	837

Setting Value	Function	Description	Ref.
32	Multi-Step Speed Reference 4	V/f CL-V/f OLV CLV AOLV OLV/PM AOLV/PM CLV/PM EZOLV Uses speed references <i>d1-01</i> to <i>d1-16</i> to set a multi-step speed reference.	837
34	PID Soft Starter Disable	V/f CL-V/f OLV CLV AOLV OLV/PM AOLV/PM CLV/PM EZOLV Sets the PID soft starter function. ON : No OFF : Yes	837
35	PID Input (Error) Invert	V/f CL-V/f OLV CLV AOLV OLV/PM AOLV/PM CLV/PM EZOLV Sets the command to turn the terminal ON and OFF to switch the PID input level (polarity).	837
3E	PID Setpoint Selection 1	V/f CL-V/f OLV CLV AOLV OLV/PM AOLV/PM CLV/PM EZOLV Set this function and <i>H1-xx = 3F</i> [PID Setpoint Selection 2] together. Sets the function to switch the PID setpoint to <i>b5-58</i> to <i>b5-60</i> [PID Setpoint 2 to 4].	837
3F	PID Setpoint Selection 2	V/f CL-V/f OLV CLV AOLV OLV/PM AOLV/PM CLV/PM EZOLV Set this function and <i>H1-xx = 3E</i> [PID Setpoint Selection 1] at the same time. Sets the function to switch the PID setpoint to <i>b5-58</i> to <i>b5-60</i> [PID Setpoint 2 to 4].	837
40	Forward RUN (2-Wire)	V/f CL-V/f OLV CLV AOLV OLV/PM AOLV/PM CLV/PM EZOLV Sets the Forward Run command for 2-wire sequence 1. Set this function and <i>H1-xx = 41</i> [Reverse Run Command (2-Wire Seq)] at the same time. ON : Forward Run OFF : Run Stop Note: • If you activate the Forward Run command terminal and the Reverse Run command terminal, the drive will detect minor fault/alarm <i>EF</i> [FWD/REV Run Command Input Error] and the motor will ramp to stop. • Initialize the drive with a 2-wire sequence to set the Forward Run command to terminal S1. • This function will not operate at the same time as <i>H1-xx = 42, 43</i> [Run Command/FWD/REV Command (2-Wire Seq 2)].	838
41	Reverse RUN (2-Wire)	V/f CL-V/f OLV CLV AOLV OLV/PM AOLV/PM CLV/PM EZOLV Sets the Forward Run command for 2-wire sequence 1. Set this function and <i>H1-xx = 40</i> [Forward Run Command (2-Wire Seq)] at the same time. ON : Reverse Run OFF : Run Stop Note: • If you activate the Forward Run command terminal and the Reverse Run command terminal, the drive will detect minor fault/alarm <i>EF</i> [FWD/REV Run Command Input Error] and the motor will ramp to stop. • Initialize the drive with a 2-wire sequence to set the Reverse Run command to terminal S2. • This function will not operate at the same time as <i>H1-xx = 42, 43</i> [Run Command/FWD/REV Command (2-Wire Seq 2)].	838
42	Run Command (2-Wire Sequence 2)	V/f CL-V/f OLV CLV AOLV OLV/PM AOLV/PM CLV/PM EZOLV Sets the Run command for 2-wire sequence 2. Set this function and <i>H1-xx = 43</i> [FWD/REV Command (2-Wire Seq 2)] at the same time. ON : Run OFF : Stop Note: This function will not operate at the same time as <i>H1-xx = 40, 41</i> [Forward/Reverse Run Command (2-Wire Seq)].	838
43	FWD/REV (2-Wire Sequence 2)	V/f CL-V/f OLV CLV AOLV OLV/PM AOLV/PM CLV/PM EZOLV Sets the direction of motor rotation for 2-wire sequence 2. Set this function and <i>H1-xx = 42</i> [Run Command (2-Wire Sequence 2)] together. ON : Reverse run OFF : Forward run Note: This function will not operate at the same time as <i>H1-xx = 40, 41</i> [Forward/Reverse Run Command (2-Wire Seq)].	839
44	Offset Frequency 1	V/f CL-V/f OLV CLV AOLV OLV/PM AOLV/PM CLV/PM EZOLV Sets the function to add the offset frequency set in <i>d7-01</i> [Offset Frequency 1] to the frequency reference when the terminal activates.	839
45	Offset Frequency 2	V/f CL-V/f OLV CLV AOLV OLV/PM AOLV/PM CLV/PM EZOLV Sets the function to add the offset frequency set in <i>d7-02</i> [Offset Frequency 2] to the frequency reference when the terminal activates.	839
46	Offset Frequency 3	V/f CL-V/f OLV CLV AOLV OLV/PM AOLV/PM CLV/PM EZOLV Sets the function to add the offset frequency set in <i>d7-03</i> [Offset Frequency 3] to the frequency reference when the terminal activates.	839
47	Node Setup (CANopen)	V/f CL-V/f OLV CLV AOLV OLV/PM AOLV/PM CLV/PM EZOLV Sets the function in CANopen communications to start the Node Setup function to set the drive node address from the host controller.	839

11.10 H: Terminal Functions

Setting Value	Function	Description	Ref.
60	DC Injection Braking Command	<p>V/f CL-V/f OLV CLV AOLV OLV/PM AOLV/PM CLV/PM EZOLV</p> <p>Sets the command to use DC Injection Braking to stop the motor.</p> <p>Note: When $A1-02 = 8$ [Control Method Selection = EZOLV], this function is available only when you use a PM motor.</p>	839
61	Speed Search from Fmax	<p>V/f CL-V/f OLV CLV AOLV OLV/PM AOLV/PM CLV/PM EZOLV</p> <p>Sets the function to start speed search using an external reference although $b3-01 = 0$ [Speed Search Selection at Start = Disabled].</p> <p>Note: The drive will detect $oPE03$ [Multi-Function Input Setting Err] when $H1-xx = 61$ and 62 are set at the same time.</p>	840
62	Speed Search from Fref	<p>V/f CL-V/f OLV CLV AOLV OLV/PM AOLV/PM CLV/PM EZOLV</p> <p>Sets the function to use an external reference to start speed search although $b3-01 = 0$ [Speed Search Selection at Start = Disabled].</p> <p>Note: The drive will detect $oPE03$ [Multi-Function Input Setting Err] when $H1-xx = 61$ and 62 are set at the same time.</p>	840
63	Field Weakening	<p>V/f CL-V/f OLV CLV AOLV OLV/PM AOLV/PM CLV/PM EZOLV</p> <p>Sets the function to send the Field Weakening Level and Field Weakening Frequency Limit commands set in $d6-01$ [Field Weakening Level] and $d6-02$ [Field Weakening Frequency Limit] when the input terminal is activated.</p>	840
65	KEB Ride-Thru 1 Activate (N.C.)	<p>V/f CL-V/f OLV CLV AOLV OLV/PM AOLV/PM CLV/PM EZOLV</p> <p>Sets operation of the KEB1 function through the KEB Ride-Thru 1 (N.C.).</p> <p>ON : Normal operation OFF : Deceleration during momentary power loss</p>	840
66	KEB Ride-Thru 1 Activate (N.O.)	<p>V/f CL-V/f OLV CLV AOLV OLV/PM AOLV/PM CLV/PM EZOLV</p> <p>Sets operation of the KEB1 function through the KEB Ride-Thru 1 (N.O.).</p> <p>ON : Deceleration during momentary power loss OFF : Normal operation</p>	841
67	Communications Test Mode	<p>V/f CL-V/f OLV CLV AOLV OLV/PM AOLV/PM CLV/PM EZOLV</p> <p>Set the function for the drive to self-test RS-485 serial communications operation.</p>	841
68	High Slip Braking	<p>V/f CL-V/f OLV CLV AOLV OLV/PM AOLV/PM CLV/PM EZOLV</p> <p>Sets the command to use high-slip braking to stop the motor.</p>	841
6A	Drive Enable	<p>V/f CL-V/f OLV CLV AOLV OLV/PM AOLV/PM CLV/PM EZOLV</p> <p>Sets the function to show dnE [Drive Enabled] on the keypad and ignore Run commands when the terminal is OFF.</p>	841
71	Torque Control	<p>V/f CL-V/f OLV CLV AOLV OLV/PM AOLV/PM CLV/PM EZOLV</p> <p>Sets the function to switch between torque control and speed control.</p> <p>ON : Torque Control OFF : Speed Control</p>	841
72	Zero Servo	<p>V/f CL-V/f OLV CLV AOLV OLV/PM AOLV/PM CLV/PM EZOLV</p> <p>Sets the function to hold a stopped motor.</p>	842
75	Up 2 Command	<p>V/f CL-V/f OLV CLV AOLV OLV/PM AOLV/PM CLV/PM EZOLV</p> <p>Sets the function to increase the frequency reference bias value to accelerate the motor when the terminal is activated. Set this function and $H1-xx = 76$ [Down 2 Command] together.</p> <p>Note: When you use this function, use $d4-08$ and $d4-09$ [Up/Down 2 Bias Upper Limit/Lower Limit] to set the optimal bias limit value.</p>	842
76	Down 2 Command	<p>V/f CL-V/f OLV CLV AOLV OLV/PM AOLV/PM CLV/PM EZOLV</p> <p>Sets the function to decrease the frequency reference bias value to decelerate the motor when the terminal is activated. Set this function and $H1-xx = 75$ [Up 2 Command] at the same time.</p> <p>Note: When you use this function, use $d4-08$ and $d4-09$ [Up/Down 2 Bias Upper Limit/Lower Limit] to set the optimal bias limit value.</p>	843
77	ASR Gain (C5-03) Select	<p>V/f CL-V/f OLV CLV AOLV OLV/PM AOLV/PM CLV/PM EZOLV</p> <p>Sets the function to switch the ASR proportional gain set in $C5-01$ [ASR Proportional Gain 1] and $C5-03$ [ASR Proportional Gain 2].</p> <p>ON : C5-03 OFF : C5-01</p>	844
78	Analog TorqueRef Polarity Invert	<p>V/f CL-V/f OLV CLV AOLV OLV/PM AOLV/PM CLV/PM EZOLV</p> <p>Sets the rotation direction of the external torque reference.</p> <p>ON : External torque reference reverse direction OFF : External torque reference forward direction</p>	844
7A	KEB Ride-Thru 2 Activate (N.C.)	<p>V/f CL-V/f OLV CLV AOLV OLV/PM AOLV/PM CLV/PM EZOLV</p> <p>Sets operation of the KEB2 function through the KEB Ride-Thru 2 (N.C.).</p> <p>ON : Normal operation OFF : Deceleration during momentary power loss</p>	844

Setting Value	Function	Description	Ref.
7B	KEB Ride-Thru 2 Activate (N.O.)	<p>V/f CL-V/f OLV CLV AOLV OLV/PM AOLV/PM CLV/PM EZOLV</p> <p>Sets operation of the KEB2 function through the KEB Ride-Thru 2 (N.O.). ON : Deceleration during momentary power loss OFF : Normal operation</p>	844
7C	Short Circuit Braking (N.O.)	<p>V/f CL-V/f OLV CLV AOLV OLV/PM AOLV/PM CLV/PM EZOLV</p> <p>Sets operation of Short Circuit Braking (N.O.). ON : Short Circuit Braking is enabled. OFF : Normal operation</p> <p>Note: When $A1-02 = 8$ [Control Method Selection = EZOLV], this function is available only when you use a PM motor.</p>	845
7D	Short Circuit Braking (N.C.)	<p>V/f CL-V/f OLV CLV AOLV OLV/PM AOLV/PM CLV/PM EZOLV</p> <p>Sets operation of Short Circuit Braking (N.C.). ON : Normal operation OFF : Short Circuit Braking is enabled.</p> <p>Note: When $A1-02 = 8$ [Control Method Selection = EZOLV], this function is available only when you use a PM motor.</p>	845
7E	Reverse Rotation Identifier	<p>V/f CL-V/f OLV CLV AOLV OLV/PM AOLV/PM CLV/PM EZOLV</p> <p>Sets the rotation direction of the motor when in Simple Closed Loop V/f Control method and $F1-21, F1-37 = 0$ [Encoder Option Function Selection = A pulse detection], or when in Closed Loop V/f Control method. ON : Reverse run OFF : Forward run</p>	845
90 - 97	DWEZ Digital Inputs 1 to 8	<p>V/f CL-V/f OLV CLV AOLV OLV/PM AOLV/PM CLV/PM EZOLV</p> <p>Sets digital inputs used with DriveWorksEZ. Refer to the DriveWorksEZ online manual for more information.</p>	845
9F	DWEZ Disable	<p>V/f CL-V/f OLV CLV AOLV OLV/PM AOLV/PM CLV/PM EZOLV</p> <p>Sets operation of the DriveWorksEZ program saved in the drive. ON : No OFF : Yes</p> <p>Note: Set $A1-07 = 2$ [DriveWorksEZ Function Selection = Digital input] to enable this function.</p>	845
101 to 19F	Inverse Inputs of 1 to 9F	<p>Sets the function of the selected MFDI to operate inversely. To select the function, enter "1xx", where the "xx" is the function setting value.</p> <p>Note: You cannot use inverse input for all functions. Refer to Table 12.55 for more information.</p>	846

◆ H2: Digital Outputs

No. (Hex.)	Name	Description	Default (Range)	Ref.
H2-01 (040B)	Term M1-M2 Function Selection	<p>V/f CL-V/f OLV CLV AOLV OLV/PM AOLV/PM CLV/PM EZOLV</p> <p>Sets the function for MFDO terminal M1-M2.</p> <p>Note: Set this parameter to <i>F</i> when the terminal is not being used or to use the terminal in through mode.</p>	0 (0 - 1FF)	848
H2-02 (040C)	Term M3-M4 Function Selection	<p>V/f CL-V/f OLV CLV AOLV OLV/PM AOLV/PM CLV/PM EZOLV</p> <p>Sets the function for MFDO terminal M3-M4.</p> <p>Note: Set this parameter to <i>F</i> when the terminal is not being used or to use the terminal in through mode.</p>	1 (0 - 1FF)	848
H2-03 (040D)	Term M5-M6 Function Selection	<p>V/f CL-V/f OLV CLV AOLV OLV/PM AOLV/PM CLV/PM EZOLV</p> <p>Sets the function for MFDO terminal M5-M6.</p> <p>Note: Set this parameter to <i>F</i> when the terminal is not being used or to use the terminal in through mode.</p>	2 (0 - 1FF)	848
H2-06 (0437)	Watt Hour Output Unit Selection	<p>V/f CL-V/f OLV CLV AOLV OLV/PM AOLV/PM CLV/PM EZOLV</p> <p>Sets the unit for the output signal when $H2-01$ to $H2-03 = 39$ [MFDO Function Selection = Watt Hour Pulse Output]. 0 : 0.1 kWh units 1 : 1 kWh units 2 : 10 kWh units 3 : 100 kWh units 4 : 1000 kWh units</p>	0 (0 - 4)	849

11.10 H: Terminal Functions

No. (Hex.)	Name	Description	Default (Range)	Ref.
H2-07 (0B3A)	Modbus Register 1 Address Select	V/f CL-V/f OLV CLV AOLV OLV/PM AOLV/PM CLV/PM EZOLV Sets the address of the MEMOBUS/Modbus register output to the MFDO terminal.	0001 (0001 - 1FFF)	849
H2-08 (0B3B)	Modbus Register 1 Bit Select	V/f CL-V/f OLV CLV AOLV OLV/PM AOLV/PM CLV/PM EZOLV Sets the bit of the MEMOBUS/Modbus register output to the MFDO terminal.	0000 (0000 - FFFF)	849
H2-09 (0B3C)	Modbus Register 2 Address Select	V/f CL-V/f OLV CLV AOLV OLV/PM AOLV/PM CLV/PM EZOLV Sets the address of the MEMOBUS/Modbus register output to the MFDO terminal.	0001 (0001 - 1FFF)	849
H2-10 (0B3D)	Modbus Register 2 Bit Select	V/f CL-V/f OLV CLV AOLV OLV/PM AOLV/PM CLV/PM EZOLV Sets the bit of the MEMOBUS/Modbus register output to the MFDO terminal.	0000 (0000 - FFFF)	850
H2-20 (1540)	Comparator 1 Monitor Selection	V/f CL-V/f OLV CLV AOLV OLV/PM AOLV/PM CLV/PM EZOLV Sets the monitor number for comparator 1. Set the x-xx part of the Ux-xx [Monitor]. For example, set H2-20 = 102 to monitor U1-02 [Output Frequency].	102 (000 - 999)	850
H2-21 (1541)	Comparator 1 Lower Limit	V/f CL-V/f OLV CLV AOLV OLV/PM AOLV/PM CLV/PM EZOLV Sets the lower limit detection level for comparator 1 when the full scale analog output for the monitor selected in H2-20 [Comparator 1 Monitor Selection] is the 100% value.	0.0% (0.0 - 300.0%)	850
H2-22 (1542)	Comparator 1 Upper Limit	V/f CL-V/f OLV CLV AOLV OLV/PM AOLV/PM CLV/PM EZOLV Sets the upper limit detection level for comparator 1 when the full scale analog output for the monitor selected in H2-20 [Comparator 1 Monitor Selection] is the 100% value.	0.0% (0.0 - 300.0%)	850
H2-23 (1543)	Comparator 1 Hysteresis	V/f CL-V/f OLV CLV AOLV OLV/PM AOLV/PM CLV/PM EZOLV Sets the hysteresis level for comparator 1 as a percentage of the full scale analog output for the monitor selected in H2-20 [Comparator 1 Monitor Selection].	0.0% (0.0 - 10.0%)	850
H2-24 (1544)	Comparator 1 On-Delay Time	V/f CL-V/f OLV CLV AOLV OLV/PM AOLV/PM CLV/PM EZOLV Sets the on-delay time for comparator 1.	0.0 s (0.0 - 600.0 s)	850
H2-25 (1545)	Comparator 1 Off-Delay Time	V/f CL-V/f OLV CLV AOLV OLV/PM AOLV/PM CLV/PM EZOLV Sets the off-delay time for comparator 1.	0.0 s (0.0 - 600.0 s)	851
H2-26 (1546)	Comparator 2 Monitor Selection	V/f CL-V/f OLV CLV AOLV OLV/PM AOLV/PM CLV/PM EZOLV Sets the monitor number for comparator 2. Set the x-xx part of the Ux-xx [Monitor]. For example, set H2-26 = 103 to monitor U1-03 [Output Current].	103 (000 - 999)	851
H2-27 (1547)	Comparator 2 Lower Limit	V/f CL-V/f OLV CLV AOLV OLV/PM AOLV/PM CLV/PM EZOLV Sets the lower limit detection level for comparator 2 as a percentage of the full scale analog output for the monitor selected in H2-26 [Comparator 2 Monitor Selection].	0.0% (0.0 - 300.0%)	851
H2-28 (1548)	Comparator 2 Upper Limit	V/f CL-V/f OLV CLV AOLV OLV/PM AOLV/PM CLV/PM EZOLV Sets the upper limit detection level for comparator 2 as a percentage of the full scale analog output for the monitor selected in H2-26 [Comparator 2 Monitor Selection].	0.0% (0.0 - 300.0%)	851
H2-29 (1549)	Comparator 2 Hysteresis	V/f CL-V/f OLV CLV AOLV OLV/PM AOLV/PM CLV/PM EZOLV Sets the hysteresis level for comparator 2 as a percentage of the full scale analog output for the monitor selected in H2-26 [Comparator 2 Monitor Selection].	0.0% (0.0 - 10.0%)	851
H2-30 (154A)	Comparator 2 On-Delay Time	V/f CL-V/f OLV CLV AOLV OLV/PM AOLV/PM CLV/PM EZOLV Sets the on-delay time for comparator 2.	0.0 s (0.0 - 600.0 s)	851
H2-31 (154B)	Comparator 2 Off-Delay Time	V/f CL-V/f OLV CLV AOLV OLV/PM AOLV/PM CLV/PM EZOLV Sets the off-delay time for comparator 2.	0.0 s (0.0 - 600.0 s)	852
H2-32 (159A)	Comparator 1 Filter Time	V/f CL-V/f OLV CLV AOLV OLV/PM AOLV/PM CLV/PM EZOLV Sets the time constant that is applied to the primary delay filter used for the analog output of the monitor selected with H2-20 [Comparator 1 Monitor Selection].	0.0s (0.0 - 10.0 s)	852
H2-33 (159B)	Comparator1 Protection Selection	V/f CL-V/f OLV CLV AOLV OLV/PM AOLV/PM CLV/PM EZOLV Sets drive operation when it detects CP1 [Comparator1 Limit Fault]. 0 : Ramp to Stop 1 : Coast to Stop 2 : Fast Stop (Use C1-09) 3 : Alarm Only 4 : Digital Output Only	4 (0 - 4)	852
H2-34 (159C)	Comparator 2 Filter Time	V/f CL-V/f OLV CLV AOLV OLV/PM AOLV/PM CLV/PM EZOLV Sets the time constant that is applied to the primary delay filter used for the analog output of the monitor selected with H2-26 [Comparator 2 Monitor Selection].	0.0s (0.0 - 10.0 s)	852
H2-35 (159D)	Comparator2 Protection Selection	V/f CL-V/f OLV CLV AOLV OLV/PM AOLV/PM CLV/PM EZOLV Sets drive operation when it detects CP2 [Comparator2 Limit Fault]. 0 : Ramp to Stop 1 : Coast to Stop 2 : Fast Stop (Use C1-09) 3 : Alarm Only 4 : Digital Output Only	4 (0 - 4)	852

No. (Hex.)	Name	Description	Default (Range)	Ref.
H2-36 (159E)	Comparator 1 Ineffective Time	V/f CL-V/f OLV CLV AOLV OLV/PM AOLV/PM CLV/PM EZOLV Sets the length of time that <i>CP1 [Comparator1 Limit Fault]</i> is disabled.	0.0 s (0.0 - 1000.0 s)	853
H2-37 (159F)	Comparator 2 Ineffective Time	V/f CL-V/f OLV CLV AOLV OLV/PM AOLV/PM CLV/PM EZOLV Sets the length of time that <i>CP2 [Comparator2 Limit Fault]</i> is disabled.	0.0 s (0.0 - 1000.0 s)	853
H2-40 (0B58)	Mbus Reg 15E0h bit0 Output Func	V/f CL-V/f OLV CLV AOLV OLV/PM AOLV/PM CLV/PM EZOLV Sets the MFDO for bit 0 of MEMOBUS register 15E0 (Hex.).	F (0 - 1FF)	853
H2-41 (0B59)	Mbus Reg 15E0h bit1 Output Func	V/f CL-V/f OLV CLV AOLV OLV/PM AOLV/PM CLV/PM EZOLV Sets the MFDO for bit 1 of MEMOBUS register 15E0 (Hex.).	F (0 - 1FF)	853
H2-42 (0B5A)	Mbus Reg 15E0h bit2 Output Func	V/f CL-V/f OLV CLV AOLV OLV/PM AOLV/PM CLV/PM EZOLV Sets the MFDO for bit 2 of MEMOBUS register 15E0 (Hex.).	F (0 - 1FF)	853
H2-60 (1B46) Expert	Term M1-M2 Secondary Function	V/f CL-V/f OLV CLV AOLV OLV/PM AOLV/PM CLV/PM EZOLV Sets the second function for terminal M1-M2. Outputs the logical calculation results of the terminals assigned to functions by <i>H2-01 [Term M1-M2 Function Selection]</i> .	F (0 - FF)	854
H2-61 (1B47) Expert	Terminal M1-M2 Logical Operation	V/f CL-V/f OLV CLV AOLV OLV/PM AOLV/PM CLV/PM EZOLV Sets the logical operation for the functions set in <i>H2-01 [Term M1-M2 Function Selection]</i> and <i>H2-60 [Term M1-M2 Secondary Function]</i> .	0 (0 - 8)	854
H2-62 (1B48) Expert	Terminal M1-M2 Delay Time	V/f CL-V/f OLV CLV AOLV OLV/PM AOLV/PM CLV/PM EZOLV Sets the minimum on time used to output the logical calculation results from terminal M1-M2.	0.1 s (0.0 - 25.0 s)	854
H2-63 (1B49) Expert	Term M3-M4 Secondary Function	V/f CL-V/f OLV CLV AOLV OLV/PM AOLV/PM CLV/PM EZOLV Sets the second function for terminal M3-M4. Outputs the logical calculation results of the terminals assigned to functions by <i>H2-02 [Term M3-M4 Function Selection]</i> .	F (0 - FF)	854
H2-64 (1B4A) Expert	Terminal M3-M4 Logical Operation	V/f CL-V/f OLV CLV AOLV OLV/PM AOLV/PM CLV/PM EZOLV Sets the logical operation for the functions set in <i>H2-02 [Term M3-M4 Function Selection]</i> and <i>H2-63 [Term M3-M4 Secondary Function]</i> .	0 (0 - 8)	854
H2-65 (1B4B) Expert	Terminal M3-M4 Delay Time	V/f CL-V/f OLV CLV AOLV OLV/PM AOLV/PM CLV/PM EZOLV Sets the minimum on time used to output the logical calculation results from terminal M3-M4.	0.1 s (0.0 - 25.0 s)	854
H2-66 (1B4C) Expert	Term M5-M6 Secondary Function	V/f CL-V/f OLV CLV AOLV OLV/PM AOLV/PM CLV/PM EZOLV Sets the second function for terminal M5-M6. Outputs the logical calculation results of the terminals assigned to functions by <i>H2-03 [Terminal M5-M6 Function Select]</i> .	F (0 - FF)	854
H2-67 (1B4D) Expert	Terminal M5-M6 Logical Operation	V/f CL-V/f OLV CLV AOLV OLV/PM AOLV/PM CLV/PM EZOLV Sets the logical operation for the functions set in <i>H2-03 [Term M5-M6 Function Selection]</i> and <i>H2-66 [Term M5-M6 Secondary Function]</i> .	0 (0 - 8)	855
H2-68 (1B4E) Expert	Terminal M5-M6 Delay Time	V/f CL-V/f OLV CLV AOLV OLV/PM AOLV/PM CLV/PM EZOLV Sets the minimum on time used to output the logical calculation results from terminal M5-M6.	0.1 s (0.0 - 25.0 s)	855

■ H2-xx: MFDO Setting Values

Setting Value	Function	Description	Ref.																														
0	During Run	<p>V/f CL-V/f OLV CLV AOLV OLV/PM AOLV/PM CLV/PM EZOLV</p> <p>The terminal activates when the Run command is input and when the drive is outputting voltage. ON : Drive is running OFF : Drive is stopping</p>	855																														
1	Zero Speed	<p>V/f CL-V/f OLV CLV AOLV OLV/PM AOLV/PM CLV/PM EZOLV</p> <p>The terminal activates when the output frequency < E1-09 [Minimum Output Frequency] or b2-01 [DC Injection/Zero Speed Threshold].</p> <p>Note: Parameter A1-02 [Control Method Selection] selects which parameter is the reference.</p> <table border="1"> <thead> <tr> <th>A1-02 Setting</th> <th>Control method selection</th> <th>Parameter Used as the Reference</th> </tr> </thead> <tbody> <tr> <td>0</td> <td>V/f</td> <td>E1-09</td> </tr> <tr> <td>1</td> <td>CL-V/f</td> <td>E1-09</td> </tr> <tr> <td>2</td> <td>OLV</td> <td>b2-01</td> </tr> <tr> <td>3</td> <td>CLV</td> <td>E1-09</td> </tr> <tr> <td>4</td> <td>AOLV</td> <td>E1-09</td> </tr> <tr> <td>5</td> <td>OLV/PM</td> <td>E1-09</td> </tr> <tr> <td>6</td> <td>AOLV/PM</td> <td>E1-09</td> </tr> <tr> <td>7</td> <td>CLV/PM</td> <td>b2-01</td> </tr> <tr> <td>8</td> <td>EZOLV</td> <td>E1-09</td> </tr> </tbody> </table> <p>ON : Output frequency < value of E1-09 or b2-01. OFF : Output frequency ≥ value of E1-09 or b2-01.</p>	A1-02 Setting	Control method selection	Parameter Used as the Reference	0	V/f	E1-09	1	CL-V/f	E1-09	2	OLV	b2-01	3	CLV	E1-09	4	AOLV	E1-09	5	OLV/PM	E1-09	6	AOLV/PM	E1-09	7	CLV/PM	b2-01	8	EZOLV	E1-09	855
A1-02 Setting	Control method selection	Parameter Used as the Reference																															
0	V/f	E1-09																															
1	CL-V/f	E1-09																															
2	OLV	b2-01																															
3	CLV	E1-09																															
4	AOLV	E1-09																															
5	OLV/PM	E1-09																															
6	AOLV/PM	E1-09																															
7	CLV/PM	b2-01																															
8	EZOLV	E1-09																															
2	Speed Agree 1	<p>V/f CL-V/f OLV CLV AOLV OLV/PM AOLV/PM CLV/PM EZOLV</p> <p>The terminal turns on when the output frequency is in the range of the frequency reference ± L4-02 [Speed Agree Detection Width].</p> <p>Note:</p> <ul style="list-style-type: none"> The detection function operates in the two motor rotation directions. The drive outputs the motor speed status when A1-02 = 3, 7 [CLV, CLV/PM]. It also outputs the motor speed status when A1-02 = 4 and n4-72 = 1. <p>ON : The output frequency is in the range of "frequency reference ± L4-02". OFF : The output frequency does not align with the frequency reference although the drive is running.</p>	856																														
3	User-Set Speed Agree 1	<p>V/f CL-V/f OLV CLV AOLV OLV/PM AOLV/PM CLV/PM EZOLV</p> <p>The terminal activates when the output frequency is in the range of L4-01 [Speed Agree Detection Level] ± L4-02 [Speed Agree Detection Width] and in the range of the frequency reference ± L4-02.</p> <p>Note:</p> <ul style="list-style-type: none"> The detection function operates in the two motor rotation directions. The drive uses the L4-01 value as the forward/reverse detection level. The drive outputs the motor speed status when A1-02 = 3, 7 [CLV, CLV/PM]. It also outputs the motor speed status when A1-02 = 4 and n4-72 = 1. <p>ON : The output frequency is in the range of "L4-01 ± L4-02" and the range of frequency reference ± L4-02. OFF : The output frequency is not in the range of "L4-01 ± L4-02" or the range of frequency reference ± L4-02.</p>	857																														
4	Frequency Detection 1	<p>V/f CL-V/f OLV CLV AOLV OLV/PM AOLV/PM CLV/PM EZOLV</p> <p>The terminal deactivates when the output frequency > L4-01 [Speed Agree Detection Level] + L4-02 [Speed Agree Detection Width]. After the terminal turns off, the terminal continues to remain off until the output frequency reaches the level set with L4-01.</p> <p>Note:</p> <ul style="list-style-type: none"> The detection function operates in the two motor rotation directions. The drive uses the L4-01 value as the forward/reverse detection level. The drive outputs the motor speed status when A1-02 = 3, 7 [CLV, CLV/PM]. It also outputs the motor speed status when A1-02 = 4 and n4-72 = 1. <p>ON : The output frequency is less than the value of L4-01 or does not exceed the value of L4-01 + L4-02. OFF : The output frequency > L4-01 + L4-02.</p>	857																														
5	Frequency Detection 2	<p>V/f CL-V/f OLV CLV AOLV OLV/PM AOLV/PM CLV/PM EZOLV</p> <p>The terminal activates when the output frequency is higher than the value of L4-01 [Speed Agree Detection Level]. After the terminal activates, the terminal stays activated until the output frequency = L4-01 - L4-02.</p> <p>Note:</p> <ul style="list-style-type: none"> The detection function operates in the two motor rotation directions. The drive uses the L4-01 value as the forward/reverse detection level. The drive outputs the motor speed status when A1-02 = 3, 7 [CLV, CLV/PM]. It also outputs the motor speed status when A1-02 = 4 and n4-72 = 1. <p>ON : The output frequency is higher than the value of L4-01. OFF : The output frequency < "L4-01 - L4-02", or ≤ L4-01.</p>	858																														

Setting Value	Function	Description	Ref.
6	Drive ready	V/f CL-V/f OLV CLV AOLV OLV/PM AOLV/PM CLV/PM EZOLV The terminal activates when the drive is ready and running.	858
7	DC Bus Undervoltage	V/f CL-V/f OLV CLV AOLV OLV/PM AOLV/PM CLV/PM EZOLV The terminal activates when the DC bus voltage or control circuit power supply is less than the voltage set with <i>L2-05 [Undervoltage Detection Lvl (Uv1)]</i> . The terminal also turns on when there is a fault with the DC bus voltage. ON : The DC bus voltage is less than the setting value of <i>L2-05</i> . OFF : The DC bus voltage is more than the setting value of <i>L2-05</i> .	858
8	During Baseblock (N.O.)	V/f CL-V/f OLV CLV AOLV OLV/PM AOLV/PM CLV/PM EZOLV The terminal turns on during baseblock. When the drive is in baseblock, the drive output transistor stops switching and does not make DC bus voltage. ON : During baseblock OFF : The drive is not in baseblock.	859
9	Frequency Reference from Keypad	V/f CL-V/f OLV CLV AOLV OLV/PM AOLV/PM CLV/PM EZOLV Shows the selected frequency reference source. ON : The keypad is the frequency reference source. OFF : Parameter <i>b1-01</i> or <i>b1-15 [Frequency Reference Selection 1 or 2]</i> is the frequency reference source.	859
A	Run Command Source	V/f CL-V/f OLV CLV AOLV OLV/PM AOLV/PM CLV/PM EZOLV Shows the selected Run command source. ON : The keypad is the Run command source. OFF : Parameter <i>b1-02</i> or <i>b1-16 [Run Command Selection 1 or 2]</i> is the Run command source.	859
B	Torque Detection 1 (N.O.)	V/f CL-V/f OLV CLV AOLV OLV/PM AOLV/PM CLV/PM EZOLV The terminal activates when the drive detects overtorque or undertorque. ON : The output current/torque > <i>L6-02 [Torque Detection Level 1]</i> , or < <i>L6-02</i> for longer than the time set with <i>L6-03 [Torque Detection Time 1]</i> .	859
C	Frequency Reference Loss	V/f CL-V/f OLV CLV AOLV OLV/PM AOLV/PM CLV/PM EZOLV The terminal activates when the drive detects a loss of frequency reference.	859
D	Braking Resistor Fault	V/f CL-V/f OLV CLV AOLV OLV/PM AOLV/PM CLV/PM EZOLV The terminal activates when the mounting-type braking resistor is overheating or when there is a braking transistor fault.	859
E	Fault	V/f CL-V/f OLV CLV AOLV OLV/PM AOLV/PM CLV/PM EZOLV The terminal activates when the drive detects a fault. Note: The terminal will not activate for <i>CPF00</i> and <i>CPF01 [Control Circuit Error]</i> faults.	860
F	Not Used	V/f CL-V/f OLV CLV AOLV OLV/PM AOLV/PM CLV/PM EZOLV Use this setting for unused terminals or to use terminals in through mode. Also use this setting as the PLC contact output via MEMOBUS/Modbus or the communication option. This signal does not function if signals from the PLC are not configured.	860
10	Alarm	V/f CL-V/f OLV CLV AOLV OLV/PM AOLV/PM CLV/PM EZOLV The terminal turns on when the drive detects a minor fault.	860
11	Fault Reset Command Active	V/f CL-V/f OLV CLV AOLV OLV/PM AOLV/PM CLV/PM EZOLV The terminal turns on when the drive receives the Reset command from the control circuit terminal, serial communications, or the communication option.	860
12	Timer Output	V/f CL-V/f OLV CLV AOLV OLV/PM AOLV/PM CLV/PM EZOLV Use this setting when the drive uses the timer function as an output terminal.	860
13	Speed Agree 2	V/f CL-V/f OLV CLV AOLV OLV/PM AOLV/PM CLV/PM EZOLV The terminal activates when the output frequency is in the range of the frequency reference $\pm L4-04$ [<i>Speed Agree Detection Width (+/-)</i>]. Note: • The detection function operates in the two motor rotation directions. • The drive outputs the motor speed status when <i>A1-02 = 3, 7 [Control Method Selection = CLV, CLV/PM]</i> . ON : The output frequency is in the range of "frequency reference $\pm L4-04$ ". OFF : The output frequency is not in the range of "frequency reference $\pm L4-04$ ".	860
14	User-Set Speed Agree 2	V/f CL-V/f OLV CLV AOLV OLV/PM AOLV/PM CLV/PM EZOLV The terminal activates when the output frequency is in the range of <i>L4-03 [Speed Agree Detection Level (+/-)]</i> $\pm L4-04$ [<i>Speed Agree Detection Width (+/-)</i>] and in the range of the frequency reference $\pm L4-04$. Note: • The detection level set in <i>L4-03</i> is a signed value. The drive will only detect in one direction. • The drive outputs the motor speed status when <i>A1-02 = 3, 7 [Control Method Selection = CLV, CLV/PM]</i> . ON : The output frequency is in the range of " <i>L4-03</i> $\pm L4-04$ " and the range of frequency reference $\pm L4-04$. OFF : The output frequency is not in the range of " <i>L4-03</i> $\pm L4-04$ " or the range of frequency reference $\pm L4-04$.	861

11.10 H: Terminal Functions

Setting Value	Function	Description	Ref.
15	Frequency Detection 3	<p>V/f CL-V/f OLV CLV AOLV OLV/PM AOLV/PM CLV/PM EZOLV</p> <p>The terminal deactivates when the output frequency is higher than the value of "L4-03 [Speed Agree Detection Level (+/-)] + L4-04 [Speed Agree Detection Width (+/-)]". After the terminal deactivates, the terminal stays off until the output frequency is at the value of L4-03.</p> <p>Note:</p> <ul style="list-style-type: none"> The detection level set in L4-03 is a signed value. The drive will only detect in one direction. The drive outputs the motor speed status when A1-02 = 3, 7 [Control Method Selection = CLV, CLV/PM]. <p>ON : The output frequency is less than the value of L4-03 or it is not higher than the value of L4-03 + L4-04. OFF : The output frequency is higher than the value of L4-03 + L4-04.</p>	861
16	Frequency Detection 4	<p>V/f CL-V/f OLV CLV AOLV OLV/PM AOLV/PM CLV/PM EZOLV</p> <p>The terminal activates when the output frequency is higher than the value of L4-03 [Speed Agree Detection Level (+/-)]. After the terminal activates, the terminal stays on until the output frequency is at the value of L4-03 - L4-04.</p> <p>Note:</p> <ul style="list-style-type: none"> The detection level set in L4-03 is a signed value. The drive will only detect in one direction. The drive outputs the motor speed status when A1-02 = 3, 7 [Control Method Selection = CLV, CLV/PM]. <p>ON : The output frequency is higher than the value of L4-03. OFF : The output frequency is less than the value of "L4-03 - L4-04", or it is not higher than the value of L4-03.</p>	862
17	Torque Detection 1 (N.C.)	<p>V/f CL-V/f OLV CLV AOLV OLV/PM AOLV/PM CLV/PM EZOLV</p> <p>The terminal deactivates when the drive detects overtorque or undertorque.</p> <p>OFF : The output current/torque is more than the torque value set with L6-02 [Torque Detection Level 1], or the level is less than the torque value set with L6-02 [Torque Detection Level 1] for longer than the time set with L6-03 [Torque Detection Time 1].</p>	862
18	Torque Detection 2 (N.O.)	<p>V/f CL-V/f OLV CLV AOLV OLV/PM AOLV/PM CLV/PM EZOLV</p> <p>The terminal activates when the drive detects overtorque or undertorque.</p> <p>ON : The output current/torque is more than the torque value set with L6-05 [Torque Detection Level 2], or the level is less than the torque value set with L6-05 [Torque Detection Level 2] for longer than the time set with L6-06 [Torque Detection Time 2].</p>	863
19	Torque Detection 2 (N.C.)	<p>V/f CL-V/f OLV CLV AOLV OLV/PM AOLV/PM CLV/PM EZOLV</p> <p>The terminal deactivates when the drive detects overtorque or undertorque.</p> <p>OFF : The output current/torque is more than the torque value set with L6-05 [Torque Detection Level 2], or the level is less than the torque value set with L6-05 [Torque Detection Level 2] for longer than the time set with L6-06 [Torque Detection Time 2].</p>	863
1A	During reverse	<p>V/f CL-V/f OLV CLV AOLV OLV/PM AOLV/PM CLV/PM EZOLV</p> <p>The terminal activates when the motor operates in the reverse direction.</p> <p>ON : The motor is operating in the reverse direction. OFF : The motor is operating in the forward direction or the motor stopped.</p>	863
1B	During Baseblock (N.C.)	<p>V/f CL-V/f OLV CLV AOLV OLV/PM AOLV/PM CLV/PM EZOLV</p> <p>The terminal deactivates during baseblock. When the drive is in baseblock, the drive output transistor stops switching and does not make DC bus voltage.</p> <p>ON : The drive is not in baseblock. OFF : During baseblock</p>	863
1C	Motor 2 Selected	<p>V/f CL-V/f OLV CLV AOLV OLV/PM AOLV/PM CLV/PM EZOLV</p> <p>The terminal activates when motor 2 is selected.</p> <p>ON : Motor 2 Selection OFF : Motor 1 Selection</p>	864
1D	During Regeneration	<p>V/f CL-V/f OLV CLV AOLV OLV/PM AOLV/PM CLV/PM EZOLV</p> <p>The terminal activates on when the motor is regenerating.</p> <p>ON : Motor is regenerating. OFF : Motor is operating or stopped.</p>	864
1E	Executing Auto-Restart	<p>V/f CL-V/f OLV CLV AOLV OLV/PM AOLV/PM CLV/PM EZOLV</p> <p>The terminal activates when the Auto Restart function is trying to restart after a fault.</p>	864
1F	Motor Overload Alarm (oL1)	<p>V/f CL-V/f OLV CLV AOLV OLV/PM AOLV/PM CLV/PM EZOLV</p> <p>The terminal activates when the electronic thermal protection value of the motor overload protective function is a minimum of 90% of the detection level.</p>	864
20	Drive Overheat Pre-Alarm (oH)	<p>V/f CL-V/f OLV CLV AOLV OLV/PM AOLV/PM CLV/PM EZOLV</p> <p>The terminal activates when the drive heatsink temperature is at the level set with L8-02 [Overheat Alarm Level].</p>	864
21	Safe Torque OFF	<p>V/f CL-V/f OLV CLV AOLV OLV/PM AOLV/PM CLV/PM EZOLV</p> <p>The terminal activates (safety stop state) when the safety circuit and safety diagnosis circuit are operating correctly and when terminals H1-HC and H2-HC are OFF (Open).</p> <p>ON : Safety stop state OFF : Safety circuit fault or RUN/READY</p>	864
22	Mechanical Weakening Detection	<p>V/f CL-V/f OLV CLV AOLV OLV/PM AOLV/PM CLV/PM EZOLV</p> <p>The terminal activates when the drive detects mechanical weakening.</p>	865

Setting Value	Function	Description	Ref.
2F	Maintenance Notification	<p>V/f CL-V/f OLV CLV AOLV OLV/PM AOLV/PM CLV/PM EZOLV</p> <p>The terminal activates when drive components are at their estimated maintenance period. Tells the user about the maintenance period for these items:</p> <ul style="list-style-type: none"> • IGBT • Cooling fan • Capacitor • Soft charge bypass relay 	865
30	During Torque Limit	<p>V/f CL-V/f OLV CLV AOLV OLV/PM AOLV/PM CLV/PM EZOLV</p> <p>The terminal activates when the torque reference is the torque limit set with <i>L7 parameters, H3-02, H3-06, or H3-10 [MFAI Function Selection]</i>.</p>	865
31	During Speed Limit	<p>V/f CL-V/f OLV CLV AOLV OLV/PM AOLV/PM CLV/PM EZOLV</p> <p>The terminal activates when the speed limit is active.</p>	865
32	In Speed Limit During Trq Ctrl	<p>V/f CL-V/f OLV CLV AOLV OLV/PM AOLV/PM CLV/PM EZOLV</p> <p>The motor accelerates in the forward direction or the reverse direction after enabling torque control and the externally input torque reference is disproportionate to the load. The output terminal activates when this speed is not higher than a constant speed and the motor speed is at the speed limit. This does not include operation when the drive is stopped.</p>	865
33	Zero Servo Complete	<p>V/f CL-V/f OLV CLV AOLV OLV/PM AOLV/PM CLV/PM EZOLV</p> <p>The terminal activates when positioning in the range set with <i>b9-02 [Zero Servo Completion Window]</i> completes after sending the Zero-Servo command.</p>	866
37	During Frequency Output	<p>V/f CL-V/f OLV CLV AOLV OLV/PM AOLV/PM CLV/PM EZOLV</p> <p>The terminal activates when the drive outputs frequency. ON : The drive outputs frequency. OFF : The drive does not output frequency.</p>	866
38	Drive Enabled	<p>V/f CL-V/f OLV CLV AOLV OLV/PM AOLV/PM CLV/PM EZOLV</p> <p>This terminal activates when the <i>H1-xx = 6A [Drive Enable]</i> terminal activates.</p>	866
39	Watt Hour Pulse Output	<p>V/f CL-V/f OLV CLV AOLV OLV/PM AOLV/PM CLV/PM EZOLV</p> <p>Outputs the pulse that shows the watt hours.</p>	866
3C	LOCAL Control Selected	<p>V/f CL-V/f OLV CLV AOLV OLV/PM AOLV/PM CLV/PM EZOLV</p> <p>The terminal activates when the Run command source or frequency reference source is LOCAL. ON : LOCAL OFF : REMOTE</p>	866
3D	During Speed Search	<p>V/f CL-V/f OLV CLV AOLV OLV/PM AOLV/PM CLV/PM EZOLV</p> <p>The terminal activates when the drive is doing speed search.</p>	867
3E	PID Feedback Low	<p>V/f CL-V/f OLV CLV AOLV OLV/PM AOLV/PM CLV/PM EZOLV</p> <p>The terminal activates when the drive detects <i>FbL [PID Feedback Loss]</i>.</p>	867
3F	PID Feedback High	<p>V/f CL-V/f OLV CLV AOLV OLV/PM AOLV/PM CLV/PM EZOLV</p> <p>The terminal activates when the drive detects <i>FbH [Excessive PID Feedback]</i>.</p>	867
4A	During KEB Ride-Thru	<p>V/f CL-V/f OLV CLV AOLV OLV/PM AOLV/PM CLV/PM EZOLV</p> <p>The activates during KEB Ride-Thru.</p>	867
4B	During Short Circuit Braking	<p>V/f CL-V/f OLV CLV AOLV OLV/PM AOLV/PM CLV/PM EZOLV</p> <p>The terminal activates during Short Circuit Braking. Note: When <i>A1-02 = 8 [Control Method Selection = EZOLV]</i>, this function is available when you use a PM motor.</p>	867
4C	During Fast Stop	<p>V/f CL-V/f OLV CLV AOLV OLV/PM AOLV/PM CLV/PM EZOLV</p> <p>The terminal activates when the fast stop is in operation.</p>	867
4D	oH Pre-Alarm Time Limit	<p>V/f CL-V/f OLV CLV AOLV OLV/PM AOLV/PM CLV/PM EZOLV</p> <p>The terminal activates when <i>L8-03 = 4 [Overheat Pre-Alarm Selection = Operate at Reduced Speed (L8-19)]</i> and <i>oH [Heatsink Overheat]</i> does not clear after the drive decreases the frequency for 10 cycles.</p>	868
4E	Braking Transistor Fault (tr)	<p>V/f CL-V/f OLV CLV AOLV OLV/PM AOLV/PM CLV/PM EZOLV</p> <p>The terminal activates when the internal braking transistor overheats and the drive detects an <i>rr [Dynamic Braking Transistor Fault]</i> fault.</p>	868
4F	Braking Resistor Overheat (rH)	<p>V/f CL-V/f OLV CLV AOLV OLV/PM AOLV/PM CLV/PM EZOLV</p> <p>The terminal activates when the braking resistor overheats and the drive detects an <i>rH [Braking Resistor Overheat]</i> fault.</p>	868
60	Internal Cooling Fan Failure	<p>V/f CL-V/f OLV CLV AOLV OLV/PM AOLV/PM CLV/PM EZOLV</p> <p>The terminal activates when the drive detects a cooling fan failure in the drive.</p>	868
61	Pole Position Detection Complete	<p>V/f CL-V/f OLV CLV AOLV OLV/PM AOLV/PM CLV/PM EZOLV</p> <p>The terminal activates when drive receives a Run command and the drive detects the motor magnetic pole position of the PM motor.</p>	868

11.10 H: Terminal Functions

Setting Value	Function	Description	Ref.
62	Modbus Reg 1 Status Satisfied	V/f CL-V/f OLV CLV AOLV OLV/PM AOLV/PM CLV/PM EZOLV The terminal activates when the bit specified by H2-08 [Modbus Register 1 Bit Select] for the MEMOBUS register address set with H2-07 [Modbus Register 1 Address Select] activates.	868
63	Modbus Reg 2 Status Satisfied	V/f CL-V/f OLV CLV AOLV OLV/PM AOLV/PM CLV/PM EZOLV The terminal activates when the bit specified by H2-10 [Modbus Register 2 Bit Select] for the MEMOBUS register address set with H2-09 [Modbus Register 2 Address Select] activates.	868
65	Standby Output	V/f CL-V/f OLV CLV AOLV OLV/PM AOLV/PM CLV/PM EZOLV The terminal deactivates after the drive stops operating and after the time set with b8-51 [Standby Mode Wait Time]. ON : The Run command turns on and the magnetic contactor on the input side turns on. OFF : The Run command turns off and the drive stops operating. Then, the magnetic contactor on the input side turns off after the time set in b8-51 [Standby Mode Wait Time] elapses.	868
66	Comparator1	V/f CL-V/f OLV CLV AOLV OLV/PM AOLV/PM CLV/PM EZOLV The terminal activates if the monitor value set with H2-20 [Comparator 1 Monitor Selection] is in range of the values of H2-21 [Comparator 1 Lower Limit] and H2-22 [Comparator 1 Upper Limit] for the time set in H2-24 [Comparator 1 On-Delay Time].	869
67	Comparator2	V/f CL-V/f OLV CLV AOLV OLV/PM AOLV/PM CLV/PM EZOLV The terminal activates if the monitor value set with H2-26 [Comparator 2 Monitor Selection] is not in the range of the values of H2-27 [Comparator 2 Lower Limit] and H2-28 [Comparator 2 Upper Limit] for the time set in H2-30 [Comparator 2 On-Delay Time].	869
69	External Power 24V Supply	V/f CL-V/f OLV CLV AOLV OLV/PM AOLV/PM CLV/PM EZOLV The terminal activates when there is an external 24V power supply between terminals PS-AC. ON : An external 24V power supply supplies power. OFF : An external 24V power supply does not supply power.	870
6A	Data Logger Error	V/f CL-V/f OLV CLV AOLV OLV/PM AOLV/PM CLV/PM EZOLV The terminal activates when the drive detects LoG [Com Error / Abnormal SD card].	870
90 to 93	DWEZ Digital Outputs 1 to 4	V/f CL-V/f OLV CLV AOLV OLV/PM AOLV/PM CLV/PM EZOLV Sets the DriveWorksEZ digital output. Refer to the DriveWorksEZ online manual for more information.	870
A0 to A7	DWEZ Extended Digital Outputs 1 to 8	V/f CL-V/f OLV CLV AOLV OLV/PM AOLV/PM CLV/PM EZOLV Sets the digital output for the DriveWorksEZ DO-A3 option card. Refer to the DriveWorksEZ online manual for more information.	870
100 to 1A7	Inverse Outputs of 0 to A7	V/f CL-V/f OLV CLV AOLV OLV/PM AOLV/PM CLV/PM EZOLV Causes inverse output of the function for the selected MFDO. Uses the last two digits of 1xx to select which function to inversely output.	870

◆ H3: Analog Inputs

No. (Hex.)	Name	Description	Default (Range)	Ref.
H3-01 (0410)	Terminal A1 Signal Level Select	V/f CL-V/f OLV CLV AOLV OLV/PM AOLV/PM CLV/PM EZOLV Sets the input signal level for MFAI terminal A1. 0 : 0 to 10V (Lower Limit at 0) 1 : -10 to +10V (Bipolar Reference) 2 : 4 to 20 mA 3 : 0 to 20 mA	0 (0 - 3)	873
H3-02 (0434)	Terminal A1 Function Selection	V/f CL-V/f OLV CLV AOLV OLV/PM AOLV/PM CLV/PM EZOLV Sets the function for MFAI terminal A1.	0 (0 - 32)	873
H3-03 (0411) RUN	Terminal A1 Gain Setting	V/f CL-V/f OLV CLV AOLV OLV/PM AOLV/PM CLV/PM EZOLV Sets the gain of the analog signal input to MFAI terminal A1.	100.0% (-999.9 - +999.9%)	873
H3-04 (0412) RUN	Terminal A1 Bias Setting	V/f CL-V/f OLV CLV AOLV OLV/PM AOLV/PM CLV/PM EZOLV Sets the bias of the analog signal input to MFAI terminal A1.	0.0% (-999.9 - +999.9%)	874
H3-05 (0413)	Terminal A3 Signal Level Select	V/f CL-V/f OLV CLV AOLV OLV/PM AOLV/PM CLV/PM EZOLV Sets the input signal level for MFAI terminal A3. 0 : 0 to 10V (Lower Limit at 0) 1 : -10 to +10V (Bipolar Reference) 2 : 4 to 20 mA 3 : 0 to 20 mA	0 (0 - 3)	874
H3-06 (0414)	Terminal A3 Function Selection	V/f CL-V/f OLV CLV AOLV OLV/PM AOLV/PM CLV/PM EZOLV Sets the function for MFAI terminal A3.	2 (0 - 32)	874

No. (Hex.)	Name	Description	Default (Range)	Ref.
H3-07 (0415) RUN	Terminal A3 Gain Setting	V/f CL-V/f OLV CLV AOLV OLV/PM AOLV/PM CLV/PM EZOLV Sets the gain of the analog signal input to MFAI terminal A3.	100.0% (-999.9 - +999.9%)	875
H3-08 (0416) RUN	Terminal A3 Bias Setting	V/f CL-V/f OLV CLV AOLV OLV/PM AOLV/PM CLV/PM EZOLV Sets the bias of the analog signal input to MFAI terminal A3.	0.0% (-999.9 - +999.9%)	875
H3-09 (0417)	Terminal A2 Signal Level Select	V/f CL-V/f OLV CLV AOLV OLV/PM AOLV/PM CLV/PM EZOLV Sets the input signal level for MFAI terminal A2. 0 : 0-10V (LowLim=0) 1 : -10 to +10V (Bipolar Reference) 2 : 4 to 20 mA 3 : 0 to 20 mA	2 (0 - 3)	875
H3-10 (0418)	Terminal A2 Function Selection	V/f CL-V/f OLV CLV AOLV OLV/PM AOLV/PM CLV/PM EZOLV Sets the function for MFAI terminal A2.	0 (0 - 32)	875
H3-11 (0419) RUN	Terminal A2 Gain Setting	V/f CL-V/f OLV CLV AOLV OLV/PM AOLV/PM CLV/PM EZOLV Sets the gain of the analog signal input to MFAI terminal A2.	100.0% (-999.9 - +999.9%)	876
H3-12 (041A) RUN	Terminal A2 Bias Setting	V/f CL-V/f OLV CLV AOLV OLV/PM AOLV/PM CLV/PM EZOLV Sets the bias of the analog signal input to MFAI terminal A2.	0.0% (-999.9 - +999.9%)	876
H3-13 (041B)	Analog Input FilterTime Constant	V/f CL-V/f OLV CLV AOLV OLV/PM AOLV/PM CLV/PM EZOLV Sets the time constant for primary delay filters on MFAI terminals.	0.03 s (0.00 - 2.00 s)	876
H3-14 (041C)	Analog Input Terminal Enable Sel	V/f CL-V/f OLV CLV AOLV OLV/PM AOLV/PM CLV/PM EZOLV Sets the enabled terminal or terminals when $H1-xx = C$ [MFDI Function Select = Analog Terminal Enable Selection] is ON. 1 : Terminal A1 only 2 : Terminal A2 only 3 : Terminals A1 and A2 4 : Terminal A3 only 5 : Terminals A1 and A3 6 : Terminals A2 and A3 7 : Terminals A1, A2, and A3	7 (1 - 7)	876
H3-16 (02F0)	Terminal A1 Offset	V/f CL-V/f OLV CLV AOLV OLV/PM AOLV/PM CLV/PM EZOLV Sets the offset level for analog signals input to terminal A1. Usually it is not necessary to change this setting.	0 (-500 - +500)	877
H3-17 (02F1)	Terminal A2 Offset	V/f CL-V/f OLV CLV AOLV OLV/PM AOLV/PM CLV/PM EZOLV Sets the offset level for analog signals input to terminal A2. Usually it is not necessary to change this setting.	0 (-500 - +500)	877
H3-18 (02F2)	Terminal A3 Offset	V/f CL-V/f OLV CLV AOLV OLV/PM AOLV/PM CLV/PM EZOLV Sets the offset level for analog signals input to terminal A3. Usually it is not necessary to change this setting.	0 (-500 - +500)	877
H3-40 (0B5C)	Mbus Reg 15C1h Input Function	V/f CL-V/f OLV CLV AOLV OLV/PM AOLV/PM CLV/PM EZOLV Sets the MEMOBUS AI1 function.	F (4 - 2F)	877
H3-41 (0B5F)	Mbus Reg 15C2h Input Function	V/f CL-V/f OLV CLV AOLV OLV/PM AOLV/PM CLV/PM EZOLV Sets the MEMOBUS AI2 function.	F (4 - 2F)	877
H3-42 (0B62)	Mbus Reg 15C3h Input Function	V/f CL-V/f OLV CLV AOLV OLV/PM AOLV/PM CLV/PM EZOLV Sets the MEMOBUS AI3 function.	F (4 - 2F)	878
H3-43 (117F)	Mbus Reg Inputs FilterTime Const	V/f CL-V/f OLV CLV AOLV OLV/PM AOLV/PM CLV/PM EZOLV Sets the time constant to apply a primary delay filter to the MEMOBUS analog input terminal.	0.00 s (0.00 - 2.00 s)	878

■ H3-xx: MFAI Setting Values

Setting Value	Function	Description	Ref.
0	Frequency Reference	V/f CL-V/f OLV CLV AOLV OLV/PM AOLV/PM CLV/PM EZOLV The input value from the MFAI terminal set with this function becomes the master frequency reference.	878
1	Frequency Gain	V/f CL-V/f OLV CLV AOLV OLV/PM AOLV/PM CLV/PM EZOLV The drive multiplies the analog frequency reference with the input value from the MFAI set with this function.	878

11.10 H: Terminal Functions

Setting Value	Function	Description	Ref.
2	Auxiliary Frequency Reference 1	<p>V/f CL-V/f OLV CLV AOLV OLV/PM AOLV/PM CLV/PM EZOLV</p> <p>Sets Reference 2 through multi-step speed reference to enable the command reference (Auxiliary Frequency Reference 1) from the analog input terminal set here. This value is a percentage where the Maximum Output Frequency setting is a setting value of 100%.</p> <p>Note: Parameter <i>A1-02</i> [Control Method Selection] selects which parameter is the maximum output frequency. • <i>A1-02</i> ≠ 8 [EZOLV]: <i>E1-04</i> [Maximum Output Frequency] • <i>A1-02</i> = 8: <i>E9-02</i> [Maximum Speed]</p>	878
3	Auxiliary Frequency Reference 2	<p>V/f CL-V/f OLV CLV AOLV OLV/PM AOLV/PM CLV/PM EZOLV</p> <p>Sets Reference 3 through multi-step speed reference to enable the command reference (Auxiliary Frequency Reference 2) from the analog input terminal set here. This value is a percentage where the Maximum Output Frequency setting is a setting value of 100%.</p> <p>Note: Parameter <i>A1-02</i> [Control Method Selection] selects which parameter is the maximum output frequency. • <i>A1-02</i> ≠ 8 [EZOLV]: <i>E1-04</i> [Maximum Output Frequency] • <i>A1-02</i> = 8: <i>E9-02</i> [Maximum Speed]</p>	879
4	Output Voltage Bias	<p>V/f CL-V/f OLV CLV AOLV OLV/PM AOLV/PM CLV/PM EZOLV</p> <p>Set this parameter to input a bias signal and amplify the output voltage.</p>	879
5	Accel/Decel Time Gain	<p>V/f CL-V/f OLV CLV AOLV OLV/PM AOLV/PM CLV/PM EZOLV</p> <p>Enters a signal to adjust the gain used for <i>C1-01</i> to <i>C1-08</i> [Acceleration/Deceleration Times 1 to 4] and <i>C1-09</i> [Fast Stop Time] when the full scale analog signal (10 V or 20 mA) is 100%.</p>	879
6	DC Injection Braking Current	<p>V/f CL-V/f OLV CLV AOLV OLV/PM AOLV/PM CLV/PM EZOLV</p> <p>Enters a signal to adjust the current level used for DC Injection Braking when the drive rated output current is 100%.</p>	879
7	Torque Detection Level	<p>V/f CL-V/f OLV CLV AOLV OLV/PM AOLV/PM CLV/PM EZOLV</p> <p>Enters a signal to adjust the overtorque/undertorque detection level.</p> <p>Note: Use this function with <i>L6-01</i> [Torque Detection Selection 1]. This parameter functions as an alternative to <i>L6-02</i> [Torque Detection Level 1].</p>	880
8	Stall Prevent Level During Run	<p>V/f CL-V/f OLV CLV AOLV OLV/PM AOLV/PM CLV/PM EZOLV</p> <p>Enters a signal to adjust the stall prevention level during run if the drive rated current is 100%.</p>	880
9	Output Frequency Lower Limit	<p>V/f CL-V/f OLV CLV AOLV OLV/PM AOLV/PM CLV/PM EZOLV</p> <p>Enters a signal to adjust the output frequency lower limit level as a percentage of the maximum output frequency.</p> <p>Note: Parameter <i>A1-02</i> [Control Method Selection] selects which parameter is the maximum output frequency. • <i>A1-02</i> ≠ 8 [EZOLV]: <i>E1-04</i> [Maximum Output Frequency] • <i>A1-02</i> = 8: <i>E9-02</i> [Maximum Speed]</p>	880
B	PID Feedback	<p>V/f CL-V/f OLV CLV AOLV OLV/PM AOLV/PM CLV/PM EZOLV</p> <p>Enter the PID feedback value as a percentage of the maximum output frequency.</p> <p>Note: Parameter <i>A1-02</i> [Control Method Selection] selects which parameter is the maximum output frequency. • <i>A1-02</i> ≠ 8 [EZOLV]: <i>E1-04</i> [Maximum Output Frequency] • <i>A1-02</i> = 8: <i>E9-02</i> [Maximum Speed]</p>	880
C	PID Setpoint	<p>V/f CL-V/f OLV CLV AOLV OLV/PM AOLV/PM CLV/PM EZOLV</p> <p>Enters the PID setpoint as a percentage of the maximum output frequency.</p> <p>Note: Parameter <i>A1-02</i> [Control Method Selection] selects which parameter is the maximum output frequency. • <i>A1-02</i> ≠ 8 [EZOLV]: <i>E1-04</i> [Maximum Output Frequency] • <i>A1-02</i> = 8: <i>E9-02</i> [Maximum Speed]</p>	881
D	Frequency Bias	<p>V/f CL-V/f OLV CLV AOLV OLV/PM AOLV/PM CLV/PM EZOLV</p> <p>Enters the bias value added to the frequency reference as a percentage of the maximum output frequency.</p> <p>Note: Parameter <i>A1-02</i> [Control Method Selection] selects which parameter is the maximum output frequency. • <i>A1-02</i> ≠ 8 [EZOLV]: <i>E1-04</i> [Maximum Output Frequency] • <i>A1-02</i> = 8: <i>E9-02</i> [Maximum Speed]</p>	881
E	Motor Temperature (PTC Input)	<p>V/f CL-V/f OLV CLV AOLV OLV/PM AOLV/PM CLV/PM EZOLV</p> <p>Uses the motor Positive Temperature Coefficient (PTC) thermistor to prevent heat damage to the motor as a percentage of the current value when the 10 V analog signal is input.</p>	881
F	Not Used	<p>V/f CL-V/f OLV CLV AOLV OLV/PM AOLV/PM CLV/PM EZOLV</p> <p>Use this setting for unused terminals or to use terminals in through mode.</p>	881
10	Forward Torque Limit	<p>V/f CL-V/f OLV CLV AOLV OLV/PM AOLV/PM CLV/PM EZOLV</p> <p>Enters the forward torque limit if the motor rated torque is 100%.</p>	881
11	Reverse Torque Limit	<p>V/f CL-V/f OLV CLV AOLV OLV/PM AOLV/PM CLV/PM EZOLV</p> <p>Enters the load torque limit if the motor rated torque is 100%.</p>	882

Setting Value	Function	Description	Ref.
12	Regenerative Torque Limit	V/f CL-V/f OLV CLV AOLV OLV/PM AOLV/PM CLV/PM EZOLV Enters the regenerative torque limit if the motor rated torque is 100%.	883
13	Torque Reference / Torque Limit	V/f CL-V/f OLV CLV AOLV OLV/PM AOLV/PM CLV/PM EZOLV Enters the torque reference if the motor rated torque is 100%. This setting is the torque limit for speed control.	883
14	Torque Compensation	V/f CL-V/f OLV CLV AOLV OLV/PM AOLV/PM CLV/PM EZOLV Enters the torque compensation value if the motor rated torque is 100%.	883
15	General Torque Limit	V/f CL-V/f OLV CLV AOLV OLV/PM AOLV/PM CLV/PM EZOLV Enters the torque limit that is the same for all quadrants for forward, reverse, and regenerative operation if the motor rated torque is 100%.	883
16	Differential PID Feedback	V/f CL-V/f OLV CLV AOLV OLV/PM AOLV/PM CLV/PM EZOLV Enters the PID differential feedback value if the full scale analog signal (10 V or 20 mA) is 100%.	883
1F	Not Used	V/f CL-V/f OLV CLV AOLV OLV/PM AOLV/PM CLV/PM EZOLV Use this setting for unused terminals or to use terminals in through mode.	883
30	DWEZ Analog Input 1	V/f CL-V/f OLV CLV AOLV OLV/PM AOLV/PM CLV/PM EZOLV Use with DriveWorksEZ. Refer to the DriveWorksEZ online manual for more information.	883
31	DWEZ Analog Input 2	V/f CL-V/f OLV CLV AOLV OLV/PM AOLV/PM CLV/PM EZOLV Use with DriveWorksEZ. Refer to the DriveWorksEZ online manual for more information.	883
32	DWEZ Analog Input 3	V/f CL-V/f OLV CLV AOLV OLV/PM AOLV/PM CLV/PM EZOLV Use with DriveWorksEZ. Refer to the DriveWorksEZ online manual for more information.	884

◆ H4: Analog Outputs

No. (Hex.)	Name	Description	Default (Range)	Ref.
H4-01 (041D)	Terminal FM Analog Output Select	V/f CL-V/f OLV CLV AOLV OLV/PM AOLV/PM CLV/PM EZOLV Sets the monitor number to send from MFAO terminal FM. Set the x-xx part of the Ux-xx [Monitor]. For example, set H4-01 = 102 to monitor U1-02 [Output Frequency].	102 (000 - 999)	885
H4-02 (041E) RUN	Terminal FM Analog Output Gain	V/f CL-V/f OLV CLV AOLV OLV/PM AOLV/PM CLV/PM EZOLV Sets the gain of the monitor signal that is sent from MFAO terminal FM. Sets the analog signal output level from the terminal FM at 10 V or 20 mA as 100% when an output for monitoring items is 100%.	100.0% (-999.9 - +999.9%)	885
H4-03 (041F) RUN	Terminal FM Analog Output Bias	V/f CL-V/f OLV CLV AOLV OLV/PM AOLV/PM CLV/PM EZOLV Sets the bias of the monitor signal that is sent from MFAO terminal FM. Set the level of the analog signal sent from terminal FM at 10 V or 20 mA as 100% when an output for monitoring items is 0%.	0.0% (-999.9 - +999.9%)	886
H4-04 (0420)	Terminal AM Analog Output Select	V/f CL-V/f OLV CLV AOLV OLV/PM AOLV/PM CLV/PM EZOLV Sets the monitoring number to be output from the MFAO terminal AM. Set the x-xx part of the Ux-xx [Monitor]. For example, set H4-04 = 103 to monitor U1-03 [Output Current].	103 (000 - 999)	886
H4-05 (0421) RUN	Terminal AM Analog Output Gain	V/f CL-V/f OLV CLV AOLV OLV/PM AOLV/PM CLV/PM EZOLV Sets the gain of the monitor signal that is sent from MFAO terminal AM. When an output for monitoring items is 0%, this parameter sets the analog signal output level from the AM terminal at 10 V or 20 mA as 100%.	50.0% (-999.9 - +999.9%)	886
H4-06 (0422) RUN	Terminal AM Analog Output Bias	V/f CL-V/f OLV CLV AOLV OLV/PM AOLV/PM CLV/PM EZOLV Sets the bias of the monitor signal that is sent from MFAO terminal AM. When an output for monitoring items is 0%, this parameter sets the analog signal output level from the AM terminal at 10 V or 20 mA as 0%.	0.0% (-999.9 - +999.9%)	886
H4-07 (0423)	Terminal FM Signal Level Select	V/f CL-V/f OLV CLV AOLV OLV/PM AOLV/PM CLV/PM EZOLV Sets the MFAO terminal FM output signal level. Note: Set jumper S5 on the control circuit terminal block accordingly when changing these parameters. 0 : 0 to 10 Vdc 1 : -10 to +10 Vdc 2 : 4 to 20 mA	0 (0 - 2)	886

11.10 H: Terminal Functions

No. (Hex.)	Name	Description	Default (Range)	Ref.
H4-08 (0424)	Terminal AM Signal Level Select	<p>V/f CL-V/f OLV CLV AOLV OLV/PM AOLV/PM CLV/PM EZOLV</p> <p>Sets the MFAO terminal AM output signal level.</p> <p>Note: Set jumper S5 on the control circuit terminal block accordingly when changing these parameters. 0 : 0 to 10 Vdc 1 : -10 to +10 Vdc 2 : 4 to 20 mA</p>	0 (0 - 2)	887
H4-20 (0B53)	Analog Power Monitor 100% Level	<p>V/f CL-V/f OLV CLV AOLV OLV/PM AOLV/PM CLV/PM EZOLV</p> <p>Sets the level at 10 V when U1-08 [Output Power] is set for analog output.</p>	0.00 kW (0.00 - 650.00 kW)	887

◆ H5: Modbus Communication

No. (Hex.)	Name	Description	Default (Range)	Ref.
H5-01 (0425)	Drive Node Address	<p>V/f CL-V/f OLV CLV AOLV OLV/PM AOLV/PM CLV/PM EZOLV</p> <p>Sets the communication slave address for drives.</p> <p>Note: • Restart the drive after changing the parameter setting. • Setting 0 will not let the drive respond to MEMOBUS/Modbus communications.</p>	1FH (0 - FFH)	887
H5-02 (0426)	Communication Speed Selection	<p>V/f CL-V/f OLV CLV AOLV OLV/PM AOLV/PM CLV/PM EZOLV</p> <p>Sets the communications speed for MEMOBUS/Modbus communications.</p> <p>Note: Restart the drive after changing the parameter setting. 0 : 1200 bps 1 : 2400 bps 2 : 4800 bps 3 : 9600 bps 4 : 19200 bps 5 : 38400 bps 6 : 57600 bps 7 : 76800 bps 8 : 115200 bps</p>	3 (0 - 8)	888
H5-03 (0427)	Communication Parity Selection	<p>V/f CL-V/f OLV CLV AOLV OLV/PM AOLV/PM CLV/PM EZOLV</p> <p>Sets the communications parity used for MEMOBUS/Modbus communications.</p> <p>Note: Restart the drive after changing the parameter setting. 0 : No parity 1 : Even parity 2 : Odd parity</p>	0 (0 - 2)	888
H5-04 (0428)	Communication Error Stop Method	<p>V/f CL-V/f OLV CLV AOLV OLV/PM AOLV/PM CLV/PM EZOLV</p> <p>Sets the motor Stopping Method when the drive detects CE [Modbus Communication Error] issues.</p> <p>0 : Ramp to Stop 1 : Coast to Stop 2 : Fast Stop (Use C1-09) 3 : Alarm Only</p>	3 (0 - 3)	888
H5-05 (0429)	Comm Fault Detection Selection	<p>V/f CL-V/f OLV CLV AOLV OLV/PM AOLV/PM CLV/PM EZOLV</p> <p>Sets the function that detects CE [Modbus Communication Error] issues during MEMOBUS/Modbus communications.</p> <p>0 : Disabled 1 : Enabled</p>	1 (0, 1)	889
H5-06 (042A)	Drive Transmit Wait Time	<p>V/f CL-V/f OLV CLV AOLV OLV/PM AOLV/PM CLV/PM EZOLV</p> <p>Sets the time to wait to send a response message after the drive receives a command message from the master.</p> <p>Note: Restart the drive after changing the parameter setting.</p>	5 ms (0 - 65 ms)	889
H5-09 (0435)	CE Detection Time	<p>V/f CL-V/f OLV CLV AOLV OLV/PM AOLV/PM CLV/PM EZOLV</p> <p>Sets the detection time for CE [Modbus Communication Error] issues when communication stops.</p>	2.0 s (0.0 - 10.0 s)	889

No. (Hex.)	Name	Description	Default (Range)	Ref.
H5-10 (0436)	Modbus Register 0025H Unit Sel	V/f CL-V/f OLV CLV AOLV OLV/PM AOLV/PM CLV/PM EZOLV Sets the unit of measure used for the MEMOBUS/Modbus communications monitor register 0025H (output voltage reference monitor). 0 : 0.1 V units 1 : 1 V units	0 (0, 1)	889
H5-11 (043C)	Comm ENTER Command Mode	V/f CL-V/f OLV CLV AOLV OLV/PM AOLV/PM CLV/PM EZOLV Sets the function to make the Enter command necessary to change parameters through MEMOBUS/Modbus communications. 0 : ENTER Command Required 1 : ENTER Command Not Required	0 (0, 1)	889
H5-12 (043D)	Run Command Method Selection	V/f CL-V/f OLV CLV AOLV OLV/PM AOLV/PM CLV/PM EZOLV Sets the input method for the Run command when $b1-02 = 2$ [Run Command Selection 1 = Memobus/Modbus Communications] or $b1-16 = 2$ [Run Command Selection 2 = Memobus/Modbus Communications]. 0 : FWD/Stop, REV/Stop 1 : Run/Stop, FWD/REV	0 (0, 1)	890
H5-17 (11A1) Expert	ENTER command response @CPU BUSY	V/f CL-V/f OLV CLV AOLV OLV/PM AOLV/PM CLV/PM EZOLV Sets operation when the EEPROM write command is sent without EEPROM write available. Usually it is not necessary to change this setting. 0 : Ignore Command (No ROM/RAM Write) 1 : Write to RAM Only	0 (0, 1)	890
H5-18 (11A2)	Motor Speed Filter over Comms	V/f CL-V/f OLV CLV AOLV OLV/PM AOLV/PM CLV/PM EZOLV Sets the filter time constant used when monitoring motor speed during MEMOBUS/Modbus communications or with a communication option.	0 ms (0 - 100 ms)	890
H5-20 (0B57)	Communication Parameters Reload	V/f CL-V/f OLV CLV AOLV OLV/PM AOLV/PM CLV/PM EZOLV Sets the function to immediately enable updated MEMOBUS/Modbus communications parameters. 0 : Reload at Next Power Cycle 1 : Reload Now	0 (0, 1)	890
H5-22 (11CF)	Speed Search from MODBUS	V/f CL-V/f OLV CLV AOLV OLV/PM AOLV/PM CLV/PM EZOLV Enables the MEMOBUS/Modbus communication register Speed Search function (bit0 of 15DFH). 0 : Disabled 1 : Enabled	0 (0, 1)	891
H5-25 (1589) RUN	Function 5A Register 1 Selection	V/f CL-V/f OLV CLV AOLV OLV/PM AOLV/PM CLV/PM EZOLV Returns the contents of the specified MEMOBUS/Modbus communications register when responding to the master device.	0044H (U1-05) (0000H - FFFFH)	891
H5-26 (158A) RUN	Function 5A Register 2 Selection	V/f CL-V/f OLV CLV AOLV OLV/PM AOLV/PM CLV/PM EZOLV Returns the contents of the specified MEMOBUS/Modbus communications register when responding to the master device.	0045H (U1-06) (0000H - FFFFH)	891
H5-27 (158B) RUN	Function 5A Register 3 Selection	V/f CL-V/f OLV CLV AOLV OLV/PM AOLV/PM CLV/PM EZOLV Returns the contents of the specified MEMOBUS/Modbus communications register when responding to the master device.	0042H (U1-03) (0000H - FFFFH)	891
H5-28 (158C) RUN	Function 5A Register 4 Selection	V/f CL-V/f OLV CLV AOLV OLV/PM AOLV/PM CLV/PM EZOLV Returns the contents of the specified MEMOBUS/Modbus communications register when responding to the master device.	0049H (U1-10) (0000H - FFFFH)	891

◆ H6: Pulse Train Input/Output

No. (Hex.)	Name	Description	Default (Range)	Ref.
H6-01 (042C)	Terminal RP Pulse Train Function	V/f CL-V/f OLV CLV AOLV OLV/PM AOLV/PM CLV/PM EZOLV Sets the function for pulse train input terminal RP. 0 : Frequency Reference 1 : PID Feedback Value 2 : PID Setpoint 3 : Speed Feedback (V/F Control)	0 (0 - 3)	892
H6-02 (042D) RUN	Terminal RP Frequency Scaling	V/f CL-V/f OLV CLV AOLV OLV/PM AOLV/PM CLV/PM EZOLV Sets the frequency of the pulse train input signal used when the item selected with H6-01 [Terminal RP Pulse Train Function] is input at 100%.	1440 Hz (100 - 32000 Hz)	893

11.10 H: Terminal Functions

No. (Hex.)	Name	Description	Default (Range)	Ref.
H6-03 (042E) RUN	Terminal RP Function Gain	V/f CL-V/f OLV CLV AOLV OLV/PM AOLV/PM CLV/PM EZOLV Sets the gain used when the function in H6-01 [Terminal RP Pulse Train Function] is input to terminal RP.	100.0% (0.0 - 1000.0%)	893
H6-04 (042F) RUN	Terminal RP Function Bias	V/f CL-V/f OLV CLV AOLV OLV/PM AOLV/PM CLV/PM EZOLV Sets the bias used when the function in H6-01 [Terminal RP Pulse Train Function] is input to terminal RP. Sets a value at the time when the pulse train is 0 Hz.	0.0% (-100.0 - 100.0%)	893
H6-05 (0430) RUN	Terminal RP Filter Time	V/f CL-V/f OLV CLV AOLV OLV/PM AOLV/PM CLV/PM EZOLV Sets the time constant for the pulse train input primary delay filters.	0.10 s (0.00 - 2.00 s)	894
H6-06 (0431) RUN	Terminal MP Monitor Selection	V/f CL-V/f OLV CLV AOLV OLV/PM AOLV/PM CLV/PM EZOLV Sets a function for pulse train monitor output terminal MP. Sets the "x-xx" part of the Ux-xx monitor.	102 (000, 031, 101, 102, 105, 116, 501, 502, 801 - 809, 821 - 825, 831 - 839, 851 - 855)	894
H6-07 (0432) RUN	Terminal MP Frequency Scaling	V/f CL-V/f OLV CLV AOLV OLV/PM AOLV/PM CLV/PM EZOLV Sets the frequency of the pulse train output signal used when the monitor set with H6-06 [Terminal MP Monitor Selection] is 100%.	1440 Hz (0 - 32000 Hz)	895
H6-08 (043F)	Terminal RP Minimum Frequency	V/f CL-V/f OLV CLV AOLV OLV/PM AOLV/PM CLV/PM EZOLV Sets the minimum frequency of the pulse train signal that terminal RP can detect.	0.5 Hz (0.1 - 1000.0 Hz)	895
H6-09 (156E)	Voltage Phase Sync MP Selection	V/f CL-V/f OLV CLV AOLV OLV/PM AOLV/PM CLV/PM EZOLV Set whether to output the pulse synchronized with drive output voltage phase from the pulse train monitor output terminal MP. This parameter is only enabled when H6-06 = 102 [Terminal MP Monitor Selection = Output Frequency] and H6-07 = 0 [Terminal MP Frequency Scaling = 0 Hz]. 0 : Disabled 1 : Enabled	0 (0, 1)	895

◆ H7: Virtual MFIO selection

No. (Hex.)	Name	Description	Default (Range)	Ref.
H7-00 (116F) Expert	Virtual MFIO selection	V/f CL-V/f OLV CLV AOLV OLV/PM AOLV/PM CLV/PM EZOLV Sets the function to enable and disable the virtual I/O function. Set this parameter to 1 to operate the virtual I/O function. 0 : No 1 : Yes	0 (0, 1)	896
H7-01 (1185) Expert	Virtual Multi-Function Input 1	V/f CL-V/f OLV CLV AOLV OLV/PM AOLV/PM CLV/PM EZOLV Sets the function that enters the virtual input set in H7-10 [Virtual Multi-Function Output 1]. Note: Settings 1B [Programming Lockout] and 11B [!Programming Lockout] are not available.	F (1 - 19F)	896
H7-02 (1186) Expert	Virtual Multi-Function Input 2	V/f CL-V/f OLV CLV AOLV OLV/PM AOLV/PM CLV/PM EZOLV Sets the function that enters the virtual input set in H7-12 [Virtual Multi-Function Output 2]. Note: Settings 1B [Programming Lockout] and 11B [!Programming Lockout] are not available.	F (1 - 19F)	896
H7-03 (1187) Expert	Virtual Multi-Function Input 3	V/f CL-V/f OLV CLV AOLV OLV/PM AOLV/PM CLV/PM EZOLV Sets the function that enters the virtual input set in H7-14 [Virtual Multi-Function Output 3]. Note: Settings 1B [Programming Lockout] and 11B [!Programming Lockout] are not available.	F (1 - 19F)	896
H7-04 (1188) Expert	Virtual Multi-Function Input 4	V/f CL-V/f OLV CLV AOLV OLV/PM AOLV/PM CLV/PM EZOLV Sets the function that enters the virtual input set in H7-16 [Virtual Multi-Function Output 4]. Note: Settings 1B [Programming Lockout] and 11B [!Programming Lockout] are not available.	F (1 - 19F)	897
H7-10 (11A4) Expert	Virtual Multi-Function Output 1	V/f CL-V/f OLV CLV AOLV OLV/PM AOLV/PM CLV/PM EZOLV Sets the function for virtual digital output 1.	F (0 - 1A7)	897

No. (Hex.)	Name	Description	Default (Range)	Ref.
H7-11 (11A5) Expert	Virtual Output 1 Delay Time	V/f CL-V/f OLV CLV AOLV OLV/PM AOLV/PM CLV/PM EZOLV Sets the minimum ON time for virtual digital output 1.	0.1 s (0.0 - 25.0 s)	897
H7-12 (11A6) Expert	Virtual Multi-Function Output 2	V/f CL-V/f OLV CLV AOLV OLV/PM AOLV/PM CLV/PM EZOLV Sets the function for virtual digital output 2.	F (0 - 1A7)	897
H7-13 (11A7) Expert	Virtual Output 2 Delay Time	V/f CL-V/f OLV CLV AOLV OLV/PM AOLV/PM CLV/PM EZOLV Sets the minimum ON time for virtual digital output 2.	0.1 s (0.0 - 25.0 s)	897
H7-14 (11A8) Expert	Virtual Multi-Function Output 3	V/f CL-V/f OLV CLV AOLV OLV/PM AOLV/PM CLV/PM EZOLV Sets the function for virtual digital output 3.	F (0 - 1A7)	897
H7-15 (11A9) Expert	Virtual Output 3 Delay Time	V/f CL-V/f OLV CLV AOLV OLV/PM AOLV/PM CLV/PM EZOLV Sets the minimum ON time for virtual digital output 3.	0.1 s (0.0 - 25.0 s)	897
H7-16 (11AA) Expert	Virtual Multi-Function Output 4	V/f CL-V/f OLV CLV AOLV OLV/PM AOLV/PM CLV/PM EZOLV Sets the function for virtual digital output 4.	F (0 - 1A7)	898
H7-17 (11AB) Expert	Virtual Output 4 Delay Time	V/f CL-V/f OLV CLV AOLV OLV/PM AOLV/PM CLV/PM EZOLV Sets the minimum ON time for virtual digital output 4.	0.1 s (0.0 - 25.0 s)	898
H7-30 (1177) Expert	Virtual Analog Input Selection	V/f CL-V/f OLV CLV AOLV OLV/PM AOLV/PM CLV/PM EZOLV Sets the virtual analog input function.	F (0 - 32)	898
H7-31 (1178) RUN Expert	Virtual Analog Input Gain	V/f CL-V/f OLV CLV AOLV OLV/PM AOLV/PM CLV/PM EZOLV Sets the virtual analog input gain.	100.0% (-999.9 - 999.9%)	898
H7-32 (1179) RUN Expert	Virtual Analog Input Bias	V/f CL-V/f OLV CLV AOLV OLV/PM AOLV/PM CLV/PM EZOLV Sets the virtual analog input bias.	0.0% (-999.9 - 999.9%)	898
H7-40 (1163)	Virtual Analog Out Signal Select	V/f CL-V/f OLV CLV AOLV OLV/PM AOLV/PM CLV/PM EZOLV Sets the signal level of the virtual analog output. 0 : 0 to 100% (Absolute Value) 1 : -100 to 100% 2 : 0 to 100% (Lower Limit at 0)	0 (0 - 2)	898
H7-41 (1164)	Virtual Analog Output Function	V/f CL-V/f OLV CLV AOLV OLV/PM AOLV/PM CLV/PM EZOLV Sets the monitor to be output from the virtual analog output. Set the x-xx part of the Ux-xx [Monitor]. For example, set H7-41 = 102 to monitor U1-02 [Output Frequency].	102 (0 - 999)	898
H7-42 (1165)	Virtual Analog Output FilterTime	V/f CL-V/f OLV CLV AOLV OLV/PM AOLV/PM CLV/PM EZOLV Sets the time constant for a primary filter of the virtual analog output.	0.00 s (0.00 - 2.00 s)	899

11.11 L: Protection Functions

◆ L1: Motor Protection

No. (Hex.)	Name	Description	Default (Range)	Ref.
L1-01 (0480)	Motor Overload (oL1) Protection	<p>V/f CL-V/f OLV CLV AOLV OLV/PM AOLV/PM CLV/PM EZOLV</p> <p>Sets the motor overload protection with electronic thermal protectors.</p> <p>0 : Disabled 1 : Variable Torque 2 : Constant Torque 10:1 Speed Range 3 : Constant Torque 100:1 SpeedRange 4 : PM Variable Torque 5 : PM Constant Torque 6 : Variable Torque (50Hz)</p> <p>Note: When only one motor is connected to a drive, set <i>L1-01</i> = 1 to 6 [Enabled]. External thermal relays are not necessary in these conditions.</p>	Determined by A1-02 (0 - 6)	254
L1-02 (0481)	Motor Overload Protection Time	<p>V/f CL-V/f OLV CLV AOLV OLV/PM AOLV/PM CLV/PM EZOLV</p> <p>Sets the operation time for the electronic thermal protector of the drive to prevent damage to the motor. Usually it is not necessary to change this setting.</p>	1.0 min (0.1 - 5.0 min)	257
L1-03 (0482)	Motor Thermistor oH Alarm Select	<p>V/f CL-V/f OLV CLV AOLV OLV/PM AOLV/PM CLV/PM EZOLV</p> <p>Sets drive operation when the PTC input signal entered into the drive is at the <i>oH3</i> [Motor Overheat Alarm] detection level.</p> <p>0 : Ramp to Stop 1 : Coast to Stop 2 : Fast Stop (Use C1-09) 3 : Alarm Only</p>	3 (0 - 3)	258
L1-04 (0483)	Motor Thermistor oH Fault Select	<p>V/f CL-V/f OLV CLV AOLV OLV/PM AOLV/PM CLV/PM EZOLV</p> <p>Sets the drive operation when the PTC input signal to the drive is at the <i>oH4</i> [Motor Overheat Fault (PTC Input)] detection level.</p> <p>0 : Ramp to Stop 1 : Coast to Stop 2 : Fast Stop (Use C1-09)</p>	1 (0 - 2)	258
L1-05 (0484)	Motor Thermistor Filter Time	<p>V/f CL-V/f OLV CLV AOLV OLV/PM AOLV/PM CLV/PM EZOLV</p> <p>Sets the primary delay time constant for the PTC input signal entered to the drive. This parameter prevents accidental motor overheat faults.</p>	0.20 s (0.00 - 10.00 s)	905
L1-08 (1103)	oL1 Current Level	<p>V/f CL-V/f OLV CLV AOLV OLV/PM AOLV/PM CLV/PM EZOLV</p> <p>Sets the reference current for the motor 1 thermal overload detection. When the current level > 0.0 A, you cannot set this value < 10% of drive rated current.</p>	0.0 A (0.0 A or 10% to 150% of the drive rated current)	905
L1-09 (1104)	oL1 Current Level for Motor 2	<p>V/f CL-V/f OLV CLV AOLV OLV/PM AOLV/PM CLV/PM EZOLV</p> <p>Sets the reference current for the motor 2 thermal overload detection. When the current level > 0.0 A, you cannot set this value < 10% of drive rated current.</p>	0.0 A (0.0 A or 10 to 150% of the drive rated current)	906
L1-13 (046D)	Motor Overload Memory Selection	<p>V/f CL-V/f OLV CLV AOLV OLV/PM AOLV/PM CLV/PM EZOLV</p> <p>Sets the function that keeps the current electronic thermal protector value when the drive stops receiving power.</p> <p>0 : Disabled 1 : Enabled</p>	1 (0, 1)	906

◆ L2: Power Loss Ride Through

No. (Hex.)	Name	Description	Default (Range)	Ref.
L2-01 (0485)	Power Loss Ride Through Select	<p>V/f CL-V/f OLV CLV AOLV OLV/PM AOLV/PM CLV/PM EZOLV</p> <p>Sets the drive operation after a momentary power loss.</p> <p>0 : Disabled 1 : Enabled 2 : Enabled while CPU Power Active 3 : Kinetic Energy Backup: L2-02 4 : Kinetic Energy Backup: CPU Power 5 : Kinetic Energy Backup: DecelStop</p>	0 (0 - 5)	912
L2-02 (0486)	Power Loss Ride Through Time	<p>V/f CL-V/f OLV CLV AOLV OLV/PM AOLV/PM CLV/PM EZOLV</p> <p>Sets the maximum time that the drive will wait until trying to restart after power loss.</p>	Determined by o2-04, C6-01 (0.0 - 25.5 s)	913
L2-03 (0487)	Minimum Baseblock Time	<p>V/f CL-V/f OLV CLV AOLV OLV/PM AOLV/PM CLV/PM EZOLV</p> <p>Sets the minimum time to continue the drive output block (baseblock) after a baseblock.</p>	Determined by o2-04, C6-01 (0.1 - 5.0 s)	913
L2-04 (0488)	Powerloss V/f Recovery Ramp Time	<p>V/f CL-V/f OLV CLV AOLV OLV/PM AOLV/PM CLV/PM EZOLV</p> <p>Sets the time for the drive output voltage to go back to correct voltage after completing speed searches.</p>	Determined by o2-04, C6-01 (0.0 - 5.0 s)	913
L2-05 (0489)	Undervoltage Detection Lvl (Uv1)	<p>V/f CL-V/f OLV CLV AOLV OLV/PM AOLV/PM CLV/PM EZOLV</p> <p>Sets the voltage at which a <i>Uv1</i> [<i>DC Bus Undervoltage</i>] fault is triggered or at which the KEB function is activated. Usually it is not necessary to change this setting.</p> <p>NOTICE: Damage to Equipment. When you set this parameter to a value lower than the default, you must install an AC reactor on the input side of the power supply. If you do not install an AC reactor, it will cause damage to the drive circuitry.</p>	Determined by o2-04 and E1-01 (200 V Class: 150 - 210 V, 400 V Class: 300 - 420 V)	914
L2-06 (048A) Expert	Kinetic Energy Backup Decel Time	<p>V/f CL-V/f OLV CLV AOLV OLV/PM AOLV/PM CLV/PM EZOLV</p> <p>Sets the deceleration time during KEB operation used to decrease the maximum output frequency to 0.</p> <p>Note: When L2-29 = 1, 2, or 3 [<i>Kinetic Energy Backup Method = Single Drive KEB Ride-Thru 2, System KEB Ride-Thru 1, or System KEB Ride-Thru 2</i>] and you do KEB Auto-Tuning, the drive will automatically set this value.</p>	0.0 s (0.0 - 6000.0 s)	914
L2-07 (048B) Expert	Kinetic Energy Backup Accel Time	<p>V/f CL-V/f OLV CLV AOLV OLV/PM AOLV/PM CLV/PM EZOLV</p> <p>Sets the acceleration time to return the frequency to the frequency reference before a power loss after canceling KEB operation.</p>	0.0 s (0.0 - 6000.0 s)	914
L2-08 (048C) Expert	Frequency Gain at KEB Start	<p>V/f CL-V/f OLV CLV AOLV OLV/PM AOLV/PM CLV/PM EZOLV</p> <p>Sets the quantity of output frequency reduction used when KEB operation starts as a percentage of the motor rated slip before starting KEB operation.</p>	100% (0 - 300%)	915
L2-09 (048D) Expert	KEB Minimum Frequency Level	<p>V/f CL-V/f OLV CLV AOLV OLV/PM AOLV/PM CLV/PM EZOLV</p> <p>Sets the quantity of output frequency reduction used as a percentage of <i>E2-02</i> [<i>Motor Rated Slip</i>] when KEB operation starts.</p>	20% (0 - 100%)	915
L2-10 (048E) Expert	Minimum KEB Time	<p>V/f CL-V/f OLV CLV AOLV OLV/PM AOLV/PM CLV/PM EZOLV</p> <p>Sets the minimum length of time to operate the KEB after the drive detects a momentary power loss.</p>	50 ms (0 - 25500 ms)	915
L2-11 (0461) Expert	KEB DC Bus Voltage Setpoint	<p>V/f CL-V/f OLV CLV AOLV OLV/PM AOLV/PM CLV/PM EZOLV</p> <p>Sets the target value that controls the DC bus voltage to a constant level in Single Drive KEB Ride-Thru 2. Sets the DC bus voltage level that completes the KEB operation for all other KEB methods.</p>	Determined by E1-01 (Determined by E1-01)	916
L2-29 (0475) Expert	Kinetic Energy Backup Method	<p>V/f CL-V/f OLV CLV AOLV OLV/PM AOLV/PM CLV/PM EZOLV</p> <p>Sets the KEB function operation mode.</p> <p>0 : Single Drive KEB Ride-Thru 1 1 : Single Drive KEB Ride-Thru 2 2 : System KEB Ride-Thru 1 3 : System KEB Ride-Thru 2</p>	0 (0 - 3)	916

11.11 L: Protection Functions

No. (Hex.)	Name	Description	Default (Range)	Ref.
L2-30 (045E) Expert	KEB Zero Speed Operation	<p>V/f CL-V/f OLV CLV AOLV OLV/PM AOLV/PM CLV/PM EZOLV</p> <p>Sets the operation when the output frequency decreases below the zero level (DC braking injection starting frequency) during KEB deceleration when <i>L2-01 = 3 to 5</i> [<i>Power Loss Ride Through Select = Kinetic Energy Backup: L2-02, Kinetic Energy Backup: CPU Power, or Kinetic Energy Backup: DecelStop</i>].</p> <p>0 : Baseblock 1 : DC Injection Braking</p>	0 (0, 1)	916
L2-31 (045D) Expert	KEB Start Voltage Offset Level	<p>V/f CL-V/f OLV CLV AOLV OLV/PM AOLV/PM CLV/PM EZOLV</p> <p>Sets the KEB start voltage offset.</p>	Determined by A1-02 (200 V Class: 0 - 100 V,400 V Class: 0 - 200 V)	917

◆ L3: Stall Prevention

No. (Hex.)	Name	Description	Default (Range)	Ref.
L3-01 (048F)	Stall Prevention during Accel	<p>V/f CL-V/f OLV CLV AOLV OLV/PM AOLV/PM CLV/PM EZOLV</p> <p>Sets the method of the Stall Prevention During Acceleration.</p> <p>0 : Disabled 1 : Enabled 2 : Intelligent (Ignore Decel Ramp) 3 : Current Limit Acceleration</p>	1 (0 - 3)	917
L3-02 (0490)	Stall Prevent Level during Accel	<p>V/f CL-V/f OLV CLV AOLV OLV/PM AOLV/PM CLV/PM EZOLV</p> <p>Sets the output current level to activate the Stall Prevention function during acceleration as a percentage of the drive rated output current.</p> <p>Note: The upper limit of the setting range changes when <i>C6-01</i> [<i>Normal / Heavy Duty Selection</i>] changes. • 150% when <i>C6-01 = 0</i> [<i>Heavy Duty Rating</i>]. • 110% when <i>C6-01 = 1</i> [<i>Normal Duty Rating</i>].</p>	Determined by C6-01 and L8-38 (0 - 150%)	919
L3-03 (0491)	Stall Prevent Limit during Accel	<p>V/f CL-V/f OLV CLV AOLV OLV/PM AOLV/PM CLV/PM EZOLV</p> <p>Sets the lower limit for the stall prevention level used in the constant output range as a percentage of the drive rated output current.</p>	50% (0 - 100%)	919
L3-04 (0492)	Stall Prevention during Decel	<p>V/f CL-V/f OLV CLV AOLV OLV/PM AOLV/PM CLV/PM EZOLV</p> <p>Sets the method that the drive will use to prevent overvoltage faults when decelerating.</p> <p>Note:</p> <ol style="list-style-type: none"> To connect a dynamic braking option (braking resistor or braking resistor unit) to the drive, set this parameter to 0 or 3. Parameter values 1, 2, 4, and 5 will enable Stall Prevention function during deceleration, and the dynamic braking option will not function. The setting range changes when the <i>A1-02</i> [<i>Control Method Selection</i>] value changes: <ul style="list-style-type: none"> When <i>A1-02 = 5</i> [<i>OLV/PM</i>], the setting range is 0 to 2. When <i>A1-02 = 6, 7, 8</i> [<i>AOLV/PM, CLV/PM, EZOLV</i>], the setting range is 0, 1. <p>0 : No 1 : General Purpose 2 : Intelligent (Ignore Decel Ramp) 3 : General Purpose w/ DB resistor 4 : Overexcitation/High Flux 5 : Overexcitation/High Flux 2</p>	1 (Determined by A1-02)	920
L3-05 (0493)	Stall Prevention during RUN	<p>V/f CL-V/f OLV CLV AOLV OLV/PM AOLV/PM CLV/PM EZOLV</p> <p>Sets the function to enable and disable Stall Prevention During Run.</p> <p>Note:</p> <ol style="list-style-type: none"> An output frequency lower than 6 Hz will disable Stall Prevention during Run. The <i>L3-05</i> and <i>L3-06</i> [<i>Stall Prevent Level during Run</i>] settings do not have an effect. The setting range changes when the <i>A1-02</i> [<i>Control Method</i>] value changes: <ul style="list-style-type: none"> <i>A1-02 = 0, 1, 5</i> [<i>V/f, CL-V/f, OLV/PM</i>]: 0 to 2 <i>A1-02 = 8</i> [<i>EZOLV</i>]: 0, 3 <p>0 : Disabled 1 : Deceleration Time 1 (C1-02) 2 : Deceleration Time 2 (C1-04) 3 : Intelligent (Ignore Decel Ramp)</p>	2 (0 - Determined by A1-02)	921

No. (Hex.)	Name	Description	Default (Range)	Ref.
L3-06 (0494)	Stall Prevent Level during Run	<p>V/f CL-V/f OLV CLV AOLV OLV/PM AOLV/PM CLV/PM EZOLV</p> <p>Sets the output current level to enable the Stall Prevention function during operation as a percentage of the drive rated output current.</p> <p>Note:</p> <ul style="list-style-type: none"> This parameter is applicable when L3-05 = 1, 2 [Stall Prevention during RUN = Deceleration Time 1 (C1-02), Deceleration Time 2 (C1-04)]. The upper limit of the setting range changes when C6-01 [Normal / Heavy Duty Selection] changes. <ul style="list-style-type: none"> -150% when C6-01 = 0 [Heavy Duty Rating (HD) for Constant Torque Applications]. -110% when C6-01 = 1 [Normal Duty Rating (ND) for Variable Torque Applications]. 	Determined by C6-01 and L8-38 (5 - 150%)	922
L3-11 (04C7)	Overvoltage Suppression Select	<p>V/f CL-V/f OLV CLV AOLV OLV/PM AOLV/PM CLV/PM EZOLV</p> <p>Sets the overvoltage suppression function.</p> <p>0 : Disabled 1 : Enabled</p>	0 (0, 1)	923
L3-17 (0462)	DC Bus Regulation Level	<p>V/f CL-V/f OLV CLV AOLV OLV/PM AOLV/PM CLV/PM EZOLV</p> <p>Sets the target value for the DC bus voltage when the overvoltage suppression function and the Decel Stall Prevention function (Intelligent Stall Prevention) are active.</p>	200 V Class: 375 V, 400 V, 750 V (200 V Class: 150 to 400 V, 400 V Class: 300 to 800 V)	923
L3-20 (0465) Expert	DC Bus Voltage Adjustment Gain	<p>V/f CL-V/f OLV CLV AOLV OLV/PM AOLV/PM CLV/PM EZOLV</p> <p>Sets the proportional gain used to control the DC bus voltage.</p>	Determined by A1-02 (0.00 - 5.00)	923
L3-21 (0466) Expert	OVSuppression Accel/Decel P Gain	<p>V/f CL-V/f OLV CLV AOLV OLV/PM AOLV/PM CLV/PM EZOLV</p> <p>Sets the proportional gain to calculate acceleration and deceleration rates.</p>	Determined by A1-02 (0.10 - 10.00)	923
L3-22 (04F9)	PM Stall Prevention Decel Time	<p>V/f CL-V/f OLV CLV AOLV OLV/PM AOLV/PM CLV/PM EZOLV</p> <p>Sets the momentary deceleration time that the drive will use when it tries to accelerate a PM motor and detected motor stalls. This function is applicable when L3-01 = 1 [Stall Prevent Select during Accel = General Purpose].</p>	0.0 s (0.0 - 6000.0 s)	924
L3-23 (04FD)	Stall P Reduction at Constant HP	<p>V/f CL-V/f OLV CLV AOLV OLV/PM AOLV/PM CLV/PM EZOLV</p> <p>Sets the function to automatically decrease the Stall Prevention Level during Run for constant output ranges.</p> <p>0 : Disabled 1 : Automatic Reduction @ CHP Region</p>	0 (0, 1)	924
L3-24 (046E) Expert	Motor Accel Time @ Rated Torque	<p>V/f CL-V/f OLV CLV AOLV OLV/PM AOLV/PM CLV/PM EZOLV</p> <p>Sets the motor acceleration time to reach the maximum frequency at the motor rated torque for stopped single-drive motors.</p>	Determined by o2-04, C6-01, E2-11, and E5-01 (0.001 - 10.000 s)	924
L3-25 (046F) Expert	Load Inertia Ratio	<p>V/f CL-V/f OLV CLV AOLV OLV/PM AOLV/PM CLV/PM EZOLV</p> <p>Sets the ratio between motor inertia and machine inertia.</p>	1.0 (0.1 - 1000.0)	925
L3-26 (0455) Expert	Additional DC Bus Capacitors	<p>V/f CL-V/f OLV CLV AOLV OLV/PM AOLV/PM CLV/PM EZOLV</p> <p>Sets the capacity for external main circuit capacitors. Usually it is not necessary to change this setting. Sets this parameter when you use the KEB Ride-Thru function.</p>	0 μF (0 to 65000 μF)	925
L3-27 (0456)	Stall Prevention Detection Time	<p>V/f CL-V/f OLV CLV AOLV OLV/PM AOLV/PM CLV/PM EZOLV</p> <p>Sets a delay time between reaching the Stall Prevention level and starting the Stall Prevention function.</p>	50 ms (0 - 5000 ms)	925
L3-34 (016F) Expert	Torque Limit Delay Time	<p>V/f CL-V/f OLV CLV AOLV OLV/PM AOLV/PM CLV/PM EZOLV</p> <p>Sets the filter time constant that returns the torque limit to its initial value when KEB operation operates in Single Drive KEB Ride-Thru mode.</p>	Determined by A1-02 (0.000 - 1.000 s)	925
L3-35 (0747) Expert	Speed Agree Width for Auto Decel	<p>V/f CL-V/f OLV CLV AOLV OLV/PM AOLV/PM CLV/PM EZOLV</p> <p>Sets the width for speed agreement when L3-04 = 2 [Decel Stall Prevention Selection = Automatic Decel Reduction]. Usually it is not necessary to change this setting.</p>	0.00 Hz (0.00 - 1.00 Hz)	926
L3-36 (11D0)	Current Suppression Gain@Accel	<p>V/f CL-V/f OLV CLV AOLV OLV/PM AOLV/PM CLV/PM EZOLV</p> <p>Sets the gain to suppress current and motor speed hunting during operation when L3-01 = 3 [Stall Prevention during Accel = Current Limit Method]. Usually it is not necessary to change this setting.</p>	Determined by A1-02 (0.0 - 100.0)	926
L3-37 (11D1) Expert	Current Limit P Gain @ Accel	<p>V/f CL-V/f OLV CLV AOLV OLV/PM AOLV/PM CLV/PM EZOLV</p> <p>Suppresses current hunting during acceleration. Usually it is not necessary to change this setting.</p>	5 ms (0 - 100 ms)	926
L3-38 (11D2) Expert	Current Limit I Time @ Accel	<p>V/f CL-V/f OLV CLV AOLV OLV/PM AOLV/PM CLV/PM EZOLV</p> <p>Suppresses current hunting and overshooting that occurs when the drive stalls during acceleration. Usually it is not necessary to change this setting.</p>	10.0 (0.0 - 100.0)	926

11.11 L: Protection Functions

No. (Hex.)	Name	Description	Default (Range)	Ref.
L3-39 (11D3)	Current Limit Filter Time @Accel	V/f CL-V/f OLV CLV AOLV OLV/PM AOLV/PM CLV/PM EZOLV Sets the time constant to adjust the acceleration rate when L3-01 = 3 [Stall Prevention during Accel = Current Limit Method]. Usually it is not necessary to change this setting.	100.0 ms (1.0 - 1000.0 ms)	926
L3-40 (11D4)	Current Limit S-Curve @ Acc/Dec	V/f CL-V/f OLV CLV AOLV OLV/PM AOLV/PM CLV/PM EZOLV Sets the function to enable and disable the best S-curve characteristic used for current-limited acceleration. 0 : Disabled 1 : Enabled	0 (0, 1)	927

◆ L4: Speed Detection

No. (Hex.)	Name	Description	Default (Range)	Ref.
L4-01 (0499)	Speed Agree Detection Level	V/f CL-V/f OLV CLV AOLV OLV/PM AOLV/PM CLV/PM EZOLV Sets the level to detect speed agree or motor speed. Sets the level to detect speed agree or motor speed when H2-01 to H2-03 = 2, 3, 4, 5 [MFDO Function Selection = Speed Agree 1, User-set Speed Agree 1, Frequency Detection 1, Frequency Detection 2].	Determined by A1-02 (Determined by A1-02)	927
L4-02 (049A)	Speed Agree Detection Width	V/f CL-V/f OLV CLV AOLV OLV/PM AOLV/PM CLV/PM EZOLV Sets the width to detect speed agree or motor speed. Sets the width to detect speed agree or motor speed when H2-01 to H2-03 = 2, 3, 4, 5 [MFDO Function Selection = Speed Agree 1, User-set Speed Agree 1, Frequency Detection 1, Frequency Detection 2].	Determined by A1-02 (Determined by A1-02)	927
L4-03 (049B)	Speed Agree Detection Level (+/-)	V/f CL-V/f OLV CLV AOLV OLV/PM AOLV/PM CLV/PM EZOLV Sets the level to detect speed agree or motor speed. Sets the speed agree detection level or motor speed detection level when H2-01 to H2-03 = 13, 14, 15, 16 [MFDO Function Selection = Speed Agree 2, User-set Speed Agree 2, Frequency Detection 3, Frequency Detection 4].	Determined by A1-02 (Determined by A1-02)	927
L4-04 (049C)	Speed Agree Detection Width (+/-)	V/f CL-V/f OLV CLV AOLV OLV/PM AOLV/PM CLV/PM EZOLV Sets the width to detect speed agree or motor speed. Sets the width to detect speed agree or motor speed when H2-01 to H2-03 = 13, 14, 15, 16 [MFDO Function Selection = Speed Agree 2, User-set Speed Agree 2, Frequency Detection 3, Frequency Detection 4].	Determined by A1-02 (Determined by A1-02)	927
L4-05 (049D)	Fref Loss Detection Selection	V/f CL-V/f OLV CLV AOLV OLV/PM AOLV/PM CLV/PM EZOLV Sets the operation when the drive detects a loss of frequency reference. 0 : Stop 1 : Run at (L4-06 x Last Reference)	0 (0, 1)	928
L4-06 (04C2)	Frequency Reference @Loss of Ref	V/f CL-V/f OLV CLV AOLV OLV/PM AOLV/PM CLV/PM EZOLV Sets the frequency reference as a percentage to continue drive operation after it detects a frequency reference loss. The value is a percentage of the frequency reference before the drive detected the loss.	80.0% (0.0 - 100.0%)	928
L4-07 (0470)	Speed Agree Detection Selection	V/f CL-V/f OLV CLV AOLV OLV/PM AOLV/PM CLV/PM EZOLV Sets the condition that activates speed detection. 0 : No Detection during Baseblock 1 : Detection Always Enabled	0 (0, 1)	928

◆ L5: Fault Restart

No. (Hex.)	Name	Description	Default (Range)	Ref.
L5-01 (049E)	Number of Auto-Restart Attempts	V/f CL-V/f OLV CLV AOLV OLV/PM AOLV/PM CLV/PM EZOLV Sets the number of times that the drive will try to restart.	0 (0 - 10 times)	929
L5-02 (049F)	Fault Contact at Restart Select	V/f CL-V/f OLV CLV AOLV OLV/PM AOLV/PM CLV/PM EZOLV Sets the function that sends signals to the MFDO terminal set for Fault [H2-xx = E] while the drive is automatically restarting. 0 : Active Only when Not Restarting 1 : Always Active	0 (0, 1)	929
L5-03 (04A0)	Continuous Method Max Restart T	V/f CL-V/f OLV CLV AOLV OLV/PM AOLV/PM CLV/PM EZOLV Sets the time for which the drive will try to restart. If the drive cannot restart in the time set in L5-03, the drive detects a fault. This is available when L5-05 = 0 [Auto-Restart Method = Continuous/Immediate Attempts].	10.0 s (0.5 - 180.0 s)	929

No. (Hex.)	Name	Description	Default (Range)	Ref.
L5-04 (046C)	Interval Method Restart Time	<p>V/f CL-V/f OLV CLV AOLV OLV/PM AOLV/PM CLV/PM EZOLV</p> <p>Sets the time interval between each Auto Restart attempt. This function is enabled when <i>L5-05 = 1</i> [Auto Restart Operation Selection = Use <i>L5-04</i> Time].</p>	10.0 s (0.5 - 600.0 s)	929
L5-05 (0467)	Auto-Restart Method	<p>V/f CL-V/f OLV CLV AOLV OLV/PM AOLV/PM CLV/PM EZOLV</p> <p>Sets the count method for the Auto Restart operation. 0 : Continuous/Immediate Attempts 1 : Interval/Attempt after <i>L5-04</i> sec</p>	0 (0, 1)	930
L5-07 (0B2A)	Fault Reset Enable Select Grp1	<p>V/f CL-V/f OLV CLV AOLV OLV/PM AOLV/PM CLV/PM EZOLV</p> <p>Use these 4 digits to set the Auto Restart function for <i>oL1</i> to <i>oL4</i>. From left to right, the digits set <i>oL1</i>, <i>oL2</i>, <i>oL3</i>, and <i>oL4</i>, in order.</p> <p>0000 : Disabled 0001 : Enabled (—/—/—/<i>oL4</i>) 0010 : Enabled (—/—/<i>oL3</i>/—) 0011 : Enabled (—/—/<i>oL3</i>/<i>oL4</i>) 0100 : Enabled (—/<i>oL2</i>/—/—) 0101 : Enabled (—/<i>oL2</i>/—/<i>oL4</i>) 0110 : Enabled (—/<i>oL2</i>/<i>oL3</i>/—) 0111 : Enabled (—/<i>oL2</i>/<i>oL3</i>/<i>oL4</i>) 1000 : Enabled (<i>oL1</i>/—/—/—) 1001 : Enabled (<i>oL1</i>/—/—/<i>oL4</i>) 1010 : Enabled (<i>oL1</i>/—/<i>oL3</i>/—) 1011 : Enabled (<i>oL1</i>/—/<i>oL3</i>/<i>oL4</i>) 1100 : Enabled (<i>oL1</i>/<i>oL2</i>/—/—) 1101 : Enabled (<i>oL1</i>/<i>oL2</i>/—/<i>oL4</i>) 1110 : Enabled (<i>oL1</i>/<i>oL2</i>/<i>oL3</i>/—) 1111 : Enabled (<i>oL1</i>/<i>oL2</i>/<i>oL3</i>/<i>oL4</i>)</p>	1111 (0000 - 1111)	930
L5-08 (0B2B)	Fault Reset Enable Select Grp2	<p>V/f CL-V/f OLV CLV AOLV OLV/PM AOLV/PM CLV/PM EZOLV</p> <p>Use these 4 digits to set the Auto Restart function for <i>Uv1</i>, <i>ov</i>, <i>oH1</i>, and <i>GF</i>. From left to right, the digits set <i>Uv1</i>, <i>ov</i>, <i>oH1</i>, and <i>GF</i>, in order.</p> <p>0000 : Disabled 0001 : Enabled (—/—/—/<i>GF</i>) 0010 : Enabled (—/—/<i>oH1</i>/—) 0011 : Enabled (—/—/<i>oH1</i>/<i>GF</i>) 0100 : Enabled (—/<i>ov</i>/—/—) 0101 : Enabled (—/<i>ov</i>/—/<i>GF</i>) 0110 : Enabled (—/<i>ov</i>/<i>oH1</i>/—) 0111 : Enabled (—/<i>ov</i>/<i>oH1</i>/<i>GF</i>) 1000 : Enabled (<i>Uv1</i>/—/—/—) 1001 : Enabled (<i>Uv1</i>/—/—/<i>GF</i>) 1010 : Enabled (<i>Uv1</i>/—/<i>oH1</i>/—) 1011 : Enabled (<i>Uv1</i>/—/<i>oH1</i>/<i>GF</i>) 1100 : Enabled (<i>Uv1</i>/<i>ov</i>/—/—) 1101 : Enabled (<i>Uv1</i>/<i>ov</i>/—/<i>GF</i>) 1110 : Enabled (<i>Uv1</i>/<i>ov</i>/<i>oH1</i>/—) 1111 : Enabled (<i>Uv1</i>/<i>ov</i>/<i>oH1</i>/<i>GF</i>)</p>	1111 (0000 - 1111)	930

◆ L6: Torque Detection

No. (Hex.)	Name	Description	Default (Range)	Ref.
L6-01 (04A1)	Torque Detection Selection 1	<p>V/f CL-V/f OLV CLV AOLV OLV/PM AOLV/PM CLV/PM EZOLV</p> <p>Sets the speed range that detects overtorque and undertorque and the operation of drives (operation status) after detection.</p> <p>0 : Disabled 1 : oL @ Speed Agree - Alarm only 2 : oL @ RUN - Alarm only 3 : oL @ Speed Agree - Fault 4 : oL @ RUN - Fault 5 : UL @ Speed Agree - Alarm only 6 : UL @ RUN - Alarm only 7 : UL @ Speed Agree - Fault 8 : UL @ RUN - Fault</p>	0 (0 - 8)	933
L6-02 (04A2)	Torque Detection Level 1	<p>V/f CL-V/f OLV CLV AOLV OLV/PM AOLV/PM CLV/PM EZOLV</p> <p>Sets the detection level for Overtorque/Undertorque Detection 1. In V/f control, drive rated output current = 100% value. In vector control, motor rated torque = 100% value.</p>	150% (0 - 300%)	934
L6-03 (04A3)	Torque Detection Time 1	<p>V/f CL-V/f OLV CLV AOLV OLV/PM AOLV/PM CLV/PM EZOLV</p> <p>Sets the detection time for Overtorque/Undertorque Detection 1.</p>	0.1 s (0.0 - 10.0 s)	934
L6-04 (04A4)	Torque Detection Selection 2	<p>V/f CL-V/f OLV CLV AOLV OLV/PM AOLV/PM CLV/PM EZOLV</p> <p>Sets the speed range that detects overtorque and undertorque and the operation of drives (operation status) after detection.</p> <p>0 : Disabled 1 : oL @ Speed Agree - Alarm only 2 : oL @ RUN - Alarm only 3 : oL @ Speed Agree - Fault 4 : oL @ RUN - Fault 5 : UL @ Speed Agree - Alarm only 6 : UL @ RUN - Alarm only 7 : UL @ Speed Agree - Fault 8 : UL @ RUN - Fault</p>	0 (0 - 8)	934
L6-05 (04A5)	Torque Detection Level 2	<p>V/f CL-V/f OLV CLV AOLV OLV/PM AOLV/PM CLV/PM EZOLV</p> <p>Sets the detection level for Overtorque/Undertorque Detection 2. In V/f control, drive rated output current = 100% value. In vector control, motor rated torque = 100% value.</p>	150% (0 - 300%)	935
L6-06 (04A6)	Torque Detection Time 2	<p>V/f CL-V/f OLV CLV AOLV OLV/PM AOLV/PM CLV/PM EZOLV</p> <p>Sets the detection time for Overtorque/Undertorque Detection 2.</p>	0.1 s (0.0 - 10.0 s)	935
L6-07 (04E5)	Torque Detection Filter Time	<p>V/f CL-V/f OLV CLV AOLV OLV/PM AOLV/PM CLV/PM EZOLV</p> <p>Sets the time constant for a primary filter to the torque reference or to the output current used to detect overtorque/undertorque.</p>	0 ms (0 - 1000 ms)	935
L6-08 (0468)	Mechanical Fatigue Detect Select	<p>V/f CL-V/f OLV CLV AOLV OLV/PM AOLV/PM CLV/PM EZOLV</p> <p>Sets the speed where the drive detects mechanical deterioration and how the drive operates (operation status) after detection.</p> <p>0 : Disabled 1 : oL5 @ Speed > L6-09 - Alarm 2 : oL5 @ ISpeedl > L6-09 - Alarm 3 : oL5 @ Speed > L6-09 - Fault 4 : oL5 @ ISpeedl > L6-09 - Fault 5 : UL5 @ Speed < L6-09 - Alarm 6 : UL5 @ ISpeedl < L6-09 - Alarm 7 : UL5 @ Speed < L6-09 - Fault 8 : UL5 @ ISpeedl < L6-09 - Fault</p>	0 (0 - 8)	935
L6-09 (0469)	Mech Fatigue Detect Speed Level	<p>V/f CL-V/f OLV CLV AOLV OLV/PM AOLV/PM CLV/PM EZOLV</p> <p>Sets the speed level where the drive will operate the mechanical deterioration detection function, as a percentage of the Maximum Output Frequency.</p> <p>Note: Parameter A1-02 [Control Method Selection] selects which parameter is the maximum output frequency. • A1-02 ≠ 8 [EZOLV]: E1-04 [Maximum Output Frequency] • A1-02 = 8: E9-02 [Maximum Speed]</p>	110.0% (-110.0 - 110.0%)	936

No. (Hex.)	Name	Description	Default (Range)	Ref.
L6-10 (046A)	Mech Fatigue Detect Delay Time	<input type="checkbox"/> V/f <input type="checkbox"/> CL-V/f <input type="checkbox"/> OLV <input type="checkbox"/> CLV <input type="checkbox"/> AOLV <input type="checkbox"/> OLV/PM <input type="checkbox"/> AOLV/PM <input type="checkbox"/> CLV/PM <input type="checkbox"/> EZOLV Sets the time for mechanical deterioration detection.	0.1 s (0.0 - 10.0 s)	936
L6-11 (046B)	Mech Fatigue Hold Off Time	<input type="checkbox"/> V/f <input type="checkbox"/> CL-V/f <input type="checkbox"/> OLV <input type="checkbox"/> CLV <input type="checkbox"/> AOLV <input type="checkbox"/> OLV/PM <input type="checkbox"/> AOLV/PM <input type="checkbox"/> CLV/PM <input type="checkbox"/> EZOLV Sets the time that the drive will start mechanical deterioration detection triggered by the cumulative operation time of the drive.	0 h (0 - 65535 h)	936

◆ L7: Torque Limit

No. (Hex.)	Name	Description	Default (Range)	Ref.
L7-01 (04A7) RUN	Forward Torque Limit	<input type="checkbox"/> V/f <input type="checkbox"/> CL-V/f <input type="checkbox"/> OLV <input type="checkbox"/> CLV <input type="checkbox"/> AOLV <input type="checkbox"/> OLV/PM <input type="checkbox"/> AOLV/PM <input type="checkbox"/> CLV/PM <input type="checkbox"/> EZOLV Sets the torque limit value for forward motoring as a percentage, where motor rated torque is the 100% value.	200% (0 - 300%)	937
L7-02 (04A8) RUN	Reverse Torque Limit	<input type="checkbox"/> V/f <input type="checkbox"/> CL-V/f <input type="checkbox"/> OLV <input type="checkbox"/> CLV <input type="checkbox"/> AOLV <input type="checkbox"/> OLV/PM <input type="checkbox"/> AOLV/PM <input type="checkbox"/> CLV/PM <input type="checkbox"/> EZOLV Sets the torque limit value for reversed motoring as a percentage, where motor rated torque is the 100% value.	200% (0 - 300%)	938
L7-03 (04A9) RUN	Forward Regenerative Trq Limit	<input type="checkbox"/> V/f <input type="checkbox"/> CL-V/f <input type="checkbox"/> OLV <input type="checkbox"/> CLV <input type="checkbox"/> AOLV <input type="checkbox"/> OLV/PM <input type="checkbox"/> AOLV/PM <input type="checkbox"/> CLV/PM <input type="checkbox"/> EZOLV Sets the torque limit value for forward regenerative conditions as a percentage of the motor rated torque.	200% (0 - 300%)	938
L7-04 (04AA) RUN	Reverse Regenerative Trq Limit	<input type="checkbox"/> V/f <input type="checkbox"/> CL-V/f <input type="checkbox"/> OLV <input type="checkbox"/> CLV <input type="checkbox"/> AOLV <input type="checkbox"/> OLV/PM <input type="checkbox"/> AOLV/PM <input type="checkbox"/> CLV/PM <input type="checkbox"/> EZOLV Sets the torque limit value for reversed regenerative conditions as a percentage of the motor rated torque.	200% (0 - 300%)	938
L7-06 (04AC)	Torque Limit Integral Time	<input type="checkbox"/> V/f <input type="checkbox"/> CL-V/f <input type="checkbox"/> OLV <input type="checkbox"/> CLV <input type="checkbox"/> AOLV <input type="checkbox"/> OLV/PM <input type="checkbox"/> AOLV/PM <input type="checkbox"/> CLV/PM <input type="checkbox"/> EZOLV Sets the integral time constant for the torque limit function.	200 ms (5 - 10000 ms)	938
L7-07 (04C9)	Torque Limit during Accel/Decel	<input type="checkbox"/> V/f <input type="checkbox"/> CL-V/f <input type="checkbox"/> OLV <input type="checkbox"/> CLV <input type="checkbox"/> AOLV <input type="checkbox"/> OLV/PM <input type="checkbox"/> AOLV/PM <input type="checkbox"/> CLV/PM <input type="checkbox"/> EZOLV Sets the torque limit function during acceleration and deceleration. 0 : Proportional only 1 : Proportional & Integral control	0 (0, 1)	939
L7-16 (044D)	Torque Limit Process at Start	<input type="checkbox"/> V/f <input type="checkbox"/> CL-V/f <input type="checkbox"/> OLV <input type="checkbox"/> CLV <input type="checkbox"/> AOLV <input type="checkbox"/> OLV/PM <input type="checkbox"/> AOLV/PM <input type="checkbox"/> CLV/PM <input type="checkbox"/> EZOLV Assigns a time filter to allow the torque limit to build at start. 0 : Disabled 1 : Enabled	1 (0, 1)	939
L7-35 (1B57) Expert	Low Freq Regen Torque Limit Lvl	<input type="checkbox"/> V/f <input type="checkbox"/> CL-V/f <input type="checkbox"/> OLV <input type="checkbox"/> CLV <input type="checkbox"/> AOLV <input type="checkbox"/> OLV/PM <input type="checkbox"/> AOLV/PM <input type="checkbox"/> CLV/PM <input type="checkbox"/> EZOLV Sets the torque limit used during low-speed regeneration. Usually it is not necessary to change this setting.	50.0% (0.0 - 200.0%)	939
L7-36 (1B58) Expert	Regen Torque Limit Derate Freq	<input type="checkbox"/> V/f <input type="checkbox"/> CL-V/f <input type="checkbox"/> OLV <input type="checkbox"/> CLV <input type="checkbox"/> AOLV <input type="checkbox"/> OLV/PM <input type="checkbox"/> AOLV/PM <input type="checkbox"/> CLV/PM <input type="checkbox"/> EZOLV Sets the frequency width at which L7-35 [Low Freq Regen Torque Limit Lvl] operates.	6.0 Hz (0.0 - 30.0 Hz)	940

◆ L8: Drive Protection

No. (Hex.)	Name	Description	Default (Range)	Ref.
L8-01 (04AD)	3% ERF DB Resistor Protection	<input type="checkbox"/> V/f <input type="checkbox"/> CL-V/f <input type="checkbox"/> OLV <input type="checkbox"/> CLV <input type="checkbox"/> AOLV <input type="checkbox"/> OLV/PM <input type="checkbox"/> AOLV/PM <input type="checkbox"/> CLV/PM <input type="checkbox"/> EZOLV Sets the function to enable braking resistor protection with a Yaskawa ERF series braking resistor (3% ED) installed on the heatsink. 0 : Disabled 1 : Enabled	0 (0, 1)	940
L8-02 (04AE)	Overheat Alarm Level	<input type="checkbox"/> V/f <input type="checkbox"/> CL-V/f <input type="checkbox"/> OLV <input type="checkbox"/> CLV <input type="checkbox"/> AOLV <input type="checkbox"/> OLV/PM <input type="checkbox"/> AOLV/PM <input type="checkbox"/> CLV/PM <input type="checkbox"/> EZOLV Sets the θH detection level in temperature.	Determined by o2-04, C6-01 (50 - 150 °C)	940
L8-03 (04AF)	Overheat Pre-Alarm Selection	<input type="checkbox"/> V/f <input type="checkbox"/> CL-V/f <input type="checkbox"/> OLV <input type="checkbox"/> CLV <input type="checkbox"/> AOLV <input type="checkbox"/> OLV/PM <input type="checkbox"/> AOLV/PM <input type="checkbox"/> CLV/PM <input type="checkbox"/> EZOLV Sets the operation of drives when an θH alarm is detected. 0 : Ramp to Stop 1 : Coast to Stop 2 : Fast Stop (Use C1-09) 3 : Alarm Only 4 : Operate at Reduced Speed (L8-19)	3 (0 - 4)	940

11.11 L: Protection Functions

No. (Hex.)	Name	Description	Default (Range)	Ref.
L8-05 (04B1)	Input Phase Loss Protection Sel	<p>V/f CL-V/f OLV CLV AOLV OLV/PM AOLV/PM CLV/PM EZOLV</p> <p>Sets the function to enable and disable input phase loss detection.</p> <p>0 : Disabled 1 : Enabled</p>	1 (0, 1)	941
L8-07 (04B3)	Output Phase Loss Protection Sel	<p>V/f CL-V/f OLV CLV AOLV OLV/PM AOLV/PM CLV/PM EZOLV</p> <p>Sets the function to enable and disable output phase loss detection. The drive starts output phase loss detection when the output current decreases to less than 5% of the drive rated current.</p> <p>Note: The drive can incorrectly start output phase loss detection in these conditions: <ul style="list-style-type: none"> The motor rated current is very small compared to the drive rating. The drive is operating a PM motor with a small load. </p> <p>0 : Disabled 1 : Fault when one phase is lost 2 : Fault when two phases are lost</p>	1 (0 - 2)	942
L8-09 (04B5)	Output Ground Fault Detection	<p>V/f CL-V/f OLV CLV AOLV OLV/PM AOLV/PM CLV/PM EZOLV</p> <p>Sets the function to enable and disable ground fault protection.</p> <p>0 : Disabled 1 : Enabled</p>	Determined by o2-04 (0, 1)	942
L8-10 (04B6)	Heatsink Fan Operation Selection	<p>V/f CL-V/f OLV CLV AOLV OLV/PM AOLV/PM CLV/PM EZOLV</p> <p>Sets operation of the heatsink cooling fan.</p> <p>0 : During Run, w/ L8-11 Off-Delay 1 : Always On 2 : On when Drive Temp Reaches L8-64</p>	0 (0 - 2)	942
L8-11 (04B7)	Heatsink Fan Off-Delay Time	<p>V/f CL-V/f OLV CLV AOLV OLV/PM AOLV/PM CLV/PM EZOLV</p> <p>Sets the length of time that the drive will wait before it stops the cooling fan after it cancels the Run command when L8-10 = 0 [Heatsink Cooling Fan Ope Select = Dur Run (OffDly)].</p>	60 s (0 - 300 s)	943
L8-12 (04B8)	Ambient Temperature Setting	<p>V/f CL-V/f OLV CLV AOLV OLV/PM AOLV/PM CLV/PM EZOLV</p> <p>Sets the ambient temperature of the drive installation area.</p>	40 °C (-10 °C - +50 °C)	943
L8-15 (04BB)	Drive oL2 @ Low Speed Protection	<p>V/f CL-V/f OLV CLV AOLV OLV/PM AOLV/PM CLV/PM EZOLV</p> <p>Sets the function to decrease drive overload at low speeds to prevent damage to the main circuit transistor during low speed operation (at 6 Hz or slower) to prevent oL2 [Drive Overloaded].</p> <p>Note: Contact Yaskawa or your nearest sales representative before disabling this function at low speeds. If you frequently operate drives with high output current in low speed ranges, it can cause heat stress and decrease the life span of drive IGBTs.</p> <p>0 : Disabled (No Additional Derate) 1 : Enabled (Reduced oL2 Level)</p>	1 (0, 1)	943
L8-18 (04BE)	Software Current Limit Selection	<p>V/f CL-V/f OLV CLV AOLV OLV/PM AOLV/PM CLV/PM EZOLV</p> <p>Set the software current limit selection function to prevent damage to the main circuit transistor caused by too much current.</p> <p>0 : Disabled 1 : Enabled</p>	0 (0, 1)	943
L8-19 (04BF)	Freq Reduction @ oH Pre-Alarm	<p>V/f CL-V/f OLV CLV AOLV OLV/PM AOLV/PM CLV/PM EZOLV</p> <p>Sets the ratio at which the drive derates the frequency reference during an oH alarm.</p>	0.8 (0.1 - 0.9)	944
L8-20 (04C0) Expert	Control Fault & Step Out Detect	<p>V/f CL-V/f OLV CLV AOLV OLV/PM AOLV/PM CLV/PM EZOLV</p> <p>Sets operation after the drive detects a CF fault when A1-02 = 4 [Control Method Selection = Advanced Open Loop Vector].</p> <p>0 : Disabled 1 : CF/STPo Detection Enabled 2 : CF ALM/Stop</p>	1 (0 - 2)	944
L8-27 (04DD)	Overcurrent Detection Gain	<p>V/f CL-V/f OLV CLV AOLV OLV/PM AOLV/PM CLV/PM EZOLV</p> <p>Sets the PM motor overcurrent detection level as a percentage of the motor rated current value.</p> <p>Note: Parameter A1-02 [Control Method Selection] selects which parameter is the motor rated current. <ul style="list-style-type: none"> A1-02 ≠ 8 [EZOLV]: E5-03 [Motor Rated Current (FLA)] A1-02 = 8: E9-06 [Motor Rated Current (FLA)] </p>	300.0% (0.0 - 1000.0%)	944
L8-29 (04DF)	Output Unbalance Detection Sel	<p>V/f CL-V/f OLV CLV AOLV OLV/PM AOLV/PM CLV/PM EZOLV</p> <p>Sets the function to detect LF2.</p> <p>0 : Disabled 1 : Enabled</p>	1 (0, 1)	944

No. (Hex.)	Name	Description	Default (Range)	Ref.
L8-31 (04E1)	LF2 Detection Time	<input type="checkbox"/> V/f <input type="checkbox"/> CL-V/f <input type="checkbox"/> OLV <input type="checkbox"/> CLV <input type="checkbox"/> AOLV <input checked="" type="checkbox"/> OLV/PM <input type="checkbox"/> AOLV/PM <input type="checkbox"/> CLV/PM <input type="checkbox"/> EZOLV Sets the LF2 [Output Current Imbalance] detection time.	3 (1 - 100)	945
L8-35 (04EC)	Installation Method Selection	<input type="checkbox"/> V/f <input type="checkbox"/> CL-V/f <input type="checkbox"/> OLV <input type="checkbox"/> CLV <input type="checkbox"/> AOLV <input checked="" type="checkbox"/> OLV/PM <input type="checkbox"/> AOLV/PM <input type="checkbox"/> CLV/PM <input type="checkbox"/> EZOLV Sets the type of drive installation. 0 : IP20/OpenChassis Enc/Ex Heatsink 1 : Side-by-Side Mounting 2 : IP20/NEMA Type 1/IP55 3 : Finless	Determined by the drive (0 - 3)	945
L8-38 (04EF)	Carrier Frequency Reduction	<input type="checkbox"/> V/f <input type="checkbox"/> CL-V/f <input type="checkbox"/> OLV <input type="checkbox"/> CLV <input type="checkbox"/> AOLV <input checked="" type="checkbox"/> OLV/PM <input type="checkbox"/> AOLV/PM <input type="checkbox"/> CLV/PM <input type="checkbox"/> EZOLV Sets the carrier frequency reduction function. The drive reduces the carrier frequency when the output current is more than a specified level. 0 : Disabled 1 : Enabled below 6 Hz 2 : Enabled for All Speeds	Determined by A1-02, C6-01 and o2-04 (0 - 2)	945
L8-40 (04F1)	Carrier Freq Reduction Off-Delay	<input type="checkbox"/> V/f <input type="checkbox"/> CL-V/f <input type="checkbox"/> OLV <input type="checkbox"/> CLV <input type="checkbox"/> AOLV <input checked="" type="checkbox"/> OLV/PM <input type="checkbox"/> AOLV/PM <input type="checkbox"/> CLV/PM <input type="checkbox"/> EZOLV Sets the length of time until the automatically reduced carrier frequency returns to the condition before the reduction.	Determined by A1-02 (0.00 - 2.00 s)	946
L8-41 (04F2)	High Current Alarm Selection	<input type="checkbox"/> V/f <input type="checkbox"/> CL-V/f <input type="checkbox"/> OLV <input type="checkbox"/> CLV <input type="checkbox"/> AOLV <input checked="" type="checkbox"/> OLV/PM <input type="checkbox"/> AOLV/PM <input type="checkbox"/> CLV/PM <input type="checkbox"/> EZOLV Sets the function to cause an HCA [Current Alarm] when the output current is more than 150% of the drive rated current. 0 : Disabled 1 : Enabled	0 (0, 1)	946
L8-51 (0471) Expert	STPo I Detection Level	<input type="checkbox"/> V/f <input type="checkbox"/> CL-V/f <input type="checkbox"/> OLV <input type="checkbox"/> CLV <input type="checkbox"/> AOLV <input checked="" type="checkbox"/> OLV/PM <input type="checkbox"/> AOLV/PM <input type="checkbox"/> CLV/PM <input type="checkbox"/> EZOLV Sets the STPo [Motor Step-Out Detected] detection level as a percentage of the motor rated current. Note: Parameter A1-02 [Control Method Selection] selects which parameter is the motor rated current. • A1-02 = 5 [OLV/PM]: E5-03 [PM Motor Rated Current (FLA)] • A1-02 = 8 [EZOLV]: E9-06 [Motor Rated Current (FLA)]	0.0% (0.0 - 300.0%)	946
L8-52 (0472) Expert	STPo Integration Level	<input type="checkbox"/> V/f <input type="checkbox"/> CL-V/f <input type="checkbox"/> OLV <input type="checkbox"/> CLV <input type="checkbox"/> AOLV <input checked="" type="checkbox"/> OLV/PM <input type="checkbox"/> AOLV/PM <input type="checkbox"/> CLV/PM <input type="checkbox"/> EZOLV Sets the detection level for STPo [Motor Step-Out Detected] related to the ACR integral value.	1.0 (0.1 - 2.0)	946
L8-53 (0473) Expert	STPo Integration Time	<input type="checkbox"/> V/f <input type="checkbox"/> CL-V/f <input type="checkbox"/> OLV <input type="checkbox"/> CLV <input type="checkbox"/> AOLV <input checked="" type="checkbox"/> OLV/PM <input type="checkbox"/> AOLV/PM <input type="checkbox"/> CLV/PM <input type="checkbox"/> EZOLV Sets the length of time until the drive detects STPo after it is more than the value of L8-51 [STPo I Detection Level].	1.0 s (1.0 - 10.0 s)	947
L8-54 (0474) Expert	STPo Id Diff Detection	<input type="checkbox"/> V/f <input type="checkbox"/> CL-V/f <input type="checkbox"/> OLV <input type="checkbox"/> CLV <input type="checkbox"/> AOLV <input checked="" type="checkbox"/> OLV/PM <input type="checkbox"/> AOLV/PM <input type="checkbox"/> CLV/PM <input type="checkbox"/> EZOLV Sets the Id deviation detection function for STPo [Motor Step-Out Detected]. 0 : Disabled 1 : Enabled	1 (0, 1)	947
L8-55 (045F)	Internal DB TransistorProtection	<input type="checkbox"/> V/f <input type="checkbox"/> CL-V/f <input type="checkbox"/> OLV <input type="checkbox"/> CLV <input type="checkbox"/> AOLV <input checked="" type="checkbox"/> OLV/PM <input type="checkbox"/> AOLV/PM <input type="checkbox"/> CLV/PM <input type="checkbox"/> EZOLV Sets the protection function for the internal braking transistor. 0 : Disable 1 : Protection Enabled	1 (0, 1)	947
L8-56 (047D) Expert	Stall P @ Accel Activation Time	<input type="checkbox"/> V/f <input type="checkbox"/> CL-V/f <input type="checkbox"/> OLV <input type="checkbox"/> CLV <input type="checkbox"/> AOLV <input checked="" type="checkbox"/> OLV/PM <input type="checkbox"/> AOLV/PM <input type="checkbox"/> CLV/PM <input type="checkbox"/> EZOLV Sets the length time that the acceleration stall prevention function can continue to operate before the drive detects an STPo [Motor Step-Out Detected].	5000 ms (100 - 5000 ms)	947
L8-57 (047E) Expert	Stall Prevention Retry Counts	<input type="checkbox"/> V/f <input type="checkbox"/> CL-V/f <input type="checkbox"/> OLV <input type="checkbox"/> CLV <input type="checkbox"/> AOLV <input checked="" type="checkbox"/> OLV/PM <input type="checkbox"/> AOLV/PM <input type="checkbox"/> CLV/PM <input type="checkbox"/> EZOLV Sets the number of times the acceleration stall prevention function can operate until speeds agree before the drive detects an STPo [Motor Step-Out Detected].	10 (1 - 10 times)	947
L8-90 (0175) Expert	STPo Detection Level (Low Speed)	<input type="checkbox"/> V/f <input type="checkbox"/> CL-V/f <input type="checkbox"/> OLV <input type="checkbox"/> CLV <input type="checkbox"/> AOLV <input checked="" type="checkbox"/> OLV/PM <input type="checkbox"/> AOLV/PM <input type="checkbox"/> CLV/PM <input type="checkbox"/> EZOLV Sets the detection level that the control fault must be equal to or more than to cause an STPo [Motor Step-Out Detected].	Determined by A1-02 (0 - 5000 times)	948
L8-93 (073C) Expert	Low Speed Pull-out DetectionTime	<input type="checkbox"/> V/f <input type="checkbox"/> CL-V/f <input type="checkbox"/> OLV <input type="checkbox"/> CLV <input type="checkbox"/> AOLV <input checked="" type="checkbox"/> OLV/PM <input type="checkbox"/> AOLV/PM <input type="checkbox"/> CLV/PM <input type="checkbox"/> EZOLV Sets the length of time the drive will wait to start baseblock after detecting LSo [Low Speed Motor Step-Out].	1.0 s (0.0 - 10.0 s)	948

11.11 L: Protection Functions

No. (Hex.)	Name	Description	Default (Range)	Ref.
L8-94 (073D) Expert	Low Speed Pull-out Detect Level	<div style="display: flex; justify-content: space-between; font-size: 0.8em; margin-bottom: 5px;"> V/f CL-V/f OLV CLV AOLV OLV/PM AOLV/PM CLV/PM EZOLV </div> Sets the detection level for <i>LSo</i> [Low Speed Motor Step-Out] as a percentage of <i>E1-04</i> [Maximum Output Frequency].	3% (0 - 10%)	948
L8-95 (077F) Expert	Low Speed Pull-out Amount	<div style="display: flex; justify-content: space-between; font-size: 0.8em; margin-bottom: 5px;"> V/f CL-V/f OLV CLV AOLV OLV/PM AOLV/PM CLV/PM EZOLV </div> Sets the average count of <i>LSo</i> [Low Speed Motor Step-Out] detections.	10 (1 - 50 times)	948

◆ L9: Drive Protection 2

No. (Hex.)	Name	Description	Default (Range)	Ref.
L9-16 (11DC) Expert	FAn1 Detect Time	<div style="display: flex; justify-content: space-between; font-size: 0.8em; margin-bottom: 5px;"> V/f CL-V/f OLV CLV AOLV OLV/PM AOLV/PM CLV/PM EZOLV </div> Sets the detection time for <i>FAn1</i> [Drive Cooling Fan Fault]. Yaskawa recommends that you do not change this parameter value.	4.0 s (0.0 - 30.0 s)	948

11.12 n: Special Adjustment

◆ n1: Hunting Prevention

No. (Hex.)	Name	Description	Default (Range)	Ref.
n1-01 (0580)	Hunting Prevention Selection	<p>V/f CL-V/f OLV CLV AOLV OLV/PM AOLV/PM CLV/PM EZOLV</p> <p>Sets the function to prevent hunting. 0 : Disabled 1 : Enabled (Normal) 2 : Enabled (High Carrier Frequency)</p>	Determined by o2-04 (0 to 2)	949
n1-02 (0581) Expert	Hunting Prevention Gain Setting	<p>V/f CL-V/f OLV CLV AOLV OLV/PM AOLV/PM CLV/PM EZOLV</p> <p>Sets the performance of the hunting prevention function. Usually it is not necessary to change this parameter.</p>	1.00 (0.00 - 2.50)	949
n1-03 (0582) Expert	Hunting Prevention Time Constant	<p>V/f CL-V/f OLV CLV AOLV OLV/PM AOLV/PM CLV/PM EZOLV</p> <p>Sets the primary delay time constant of the hunting prevention function. Usually it is not necessary to change this parameter.</p>	Determined by o2-04 (0 - 500 ms)	949
n1-05 (0530) Expert	Hunting Prevent Gain in Reverse	<p>V/f CL-V/f OLV CLV AOLV OLV/PM AOLV/PM CLV/PM EZOLV</p> <p>Sets the performance of the hunting prevention function. This parameter adjusts Reverse run. Usually it is not necessary to change this parameter.</p>	0.00 (0.00 - 2.50)	950
n1-08 (1105) Expert	Current Detection Method	<p>V/f CL-V/f OLV CLV AOLV OLV/PM AOLV/PM CLV/PM EZOLV</p> <p>Sets how the drive decreases the motor vibration that is caused by leakage current. Usually it is not necessary to change this parameter. 0 : 2-Phases 1 : 3-Phases</p>	0 (0, 1)	950
n1-13 (1B59) Expert	DC Bus Stabilization Control	<p>V/f CL-V/f OLV CLV AOLV OLV/PM AOLV/PM CLV/PM EZOLV</p> <p>Sets the oscillation suppression function for the DC bus voltage. 0 : Disabled 1 : Enabled</p>	0 (0, 1)	950
n1-14 (1B5A) Expert	DC Bus Stabilization Time	<p>V/f CL-V/f OLV CLV AOLV OLV/PM AOLV/PM CLV/PM EZOLV</p> <p>Adjusts the responsiveness of the oscillation suppression function for the DC bus voltage. Set $n1-13 = 1$ [DC Bus Stabilization Control = Enabled] to enable this parameter.</p>	100.0 ms (50.0 - 500.0 ms)	950
n1-15 (0BF8) Expert	PWM Voltage Offset Calibration	<p>V/f CL-V/f OLV CLV AOLV OLV/PM AOLV/PM CLV/PM EZOLV</p> <p>Sets the calibration method that the drive uses to decrease torque/current ripple. 0 : No Calibration 1 : One Time Calibrate at Next Start 2 : Calibrate Every Time at Start</p>	Determined by A1-02 (0 - 2)	950
n1-16 (0BFB) Expert	Hunting Prevention High Fc Gain	<p>V/f CL-V/f OLV CLV AOLV OLV/PM AOLV/PM CLV/PM EZOLV</p> <p>Sets the gain for the hunting prevention function. This parameter functions best with a high carrier frequency. Usually it is not necessary to change this parameter.</p>	Determined by o2-04 (0.00 - 2.50)	951
n1-17 (0BFC) Expert	Hunting Prevent High Fc Filter	<p>V/f CL-V/f OLV CLV AOLV OLV/PM AOLV/PM CLV/PM EZOLV</p> <p>Sets the responsiveness of the hunting prevention function. Usually it is not necessary to change this parameter.</p>	500 ms (0 - 1000 ms)	951
n1-20 (1588) Expert	Voltage Calibration Duration	<p>V/f CL-V/f OLV CLV AOLV OLV/PM AOLV/PM CLV/PM EZOLV</p> <p>Sets the calibration time at start. Usually it is not necessary to change this parameter.</p>	50 ms (10 - 500 ms)	951

◆ n2: Auto Freq Regulator (AFR)

No. (Hex.)	Name	Description	Default (Range)	Ref.
n2-01 (0584)	Automatic Freq Regulator Gain	<p>V/f CL-V/f OLV CLV AOLV OLV/PM AOLV/PM CLV/PM EZOLV</p> <p>Sets the gain of the AFR function as a magnification value. Usually it is not necessary to change this setting.</p>	1.00 (0.00 - 10.00)	951
n2-02 (0585)	Automatic Freq Regulator Time 1	<p>V/f CL-V/f OLV CLV AOLV OLV/PM AOLV/PM CLV/PM EZOLV</p> <p>Sets the time constant that sets the rate of change for the AFR function. Usually it is not necessary to change this setting.</p>	50 ms (0 - 2000 ms)	952
n2-03 (0586)	Automatic Freq Regulator Time 2	<p>V/f CL-V/f OLV CLV AOLV OLV/PM AOLV/PM CLV/PM EZOLV</p> <p>Sets the time constant that sets the speed difference of the AFR function. Use this parameter for speed searches or regeneration. Usually it is not necessary to change this setting.</p>	750 ms (0 - 2000 ms)	952

◆ n3: High Slip/Overexcite Braking

No. (Hex.)	Name	Description	Default (Range)	Ref.
n3-01 (0588) Expert	HSB Deceleration Frequency Width	<p>V/f CL-V/f OLV CLV AOLV OLV/PM AOLV/PM CLV/PM EZOLV</p> <p>Sets the amount by which the output frequency is to be lowered during high-slip braking, as a percentage of E1-04 [Maximum Output Frequency], which represents the 100% value.</p>	5% (1 - 20%)	954
n3-02 (0589) Expert	HSB Current Limit Level	<p>V/f CL-V/f OLV CLV AOLV OLV/PM AOLV/PM CLV/PM EZOLV</p> <p>Sets the maximum current output during high-slip braking as a percentage of E2-01 [Motor Rated Current (FLA)]. Also set the current suppression to prevent exceeding drive overload tolerance.</p> <p>Note: The upper limit of the setting range changes when the setting for C6-01 [Normal / Heavy Duty Selection] changes.</p> <ul style="list-style-type: none"> • 150% when C6-01 = 0 [Heavy Duty Rating (HD) for Constant Torque Applications]. • 110% when C6-01 = 1 [Normal Duty Rating (ND) for Variable Torque Applications]. 	Determined by C6-01, L8-38 (0 - 150%)	954
n3-03 (058A) Expert	HSB Dwell Time at Stop	<p>V/f CL-V/f OLV CLV AOLV OLV/PM AOLV/PM CLV/PM EZOLV</p> <p>Sets the dwell time, a length of time when high-slip braking is ending and during which the motor speed decreases and runs at a stable speed. For a set length of time, the drive will hold the actual output frequency at the minimum output frequency set in E1-09.</p>	1.0 s (0.0 - 10.0 s)	954
n3-04 (058B) Expert	HSB Overload Time	<p>V/f CL-V/f OLV CLV AOLV OLV/PM AOLV/PM CLV/PM EZOLV</p> <p>Sets the time used to detect oL7 [High Slip Braking Overload], which occurs when the output frequency does not change during high-slip braking. Usually it is not necessary to change this parameter.</p>	40 s (30 - 1200 s)	954
n3-13 (0531)	OverexcitationBraking (OEB) Gain	<p>V/f CL-V/f OLV CLV AOLV OLV/PM AOLV/PM CLV/PM EZOLV</p> <p>Sets the gain value that the drive multiplies by the V/f pattern output value during overexcitation deceleration to calculate the overexcitation level.</p>	1.10 (1.00 - 1.40)	955
n3-14 (0532) Expert	OEB High Frequency Injection	<p>V/f CL-V/f OLV CLV AOLV OLV/PM AOLV/PM CLV/PM EZOLV</p> <p>Sets the function that injects harmonic signals during overexcitation deceleration.</p> <p>0 : Disabled 1 : Enabled</p>	0 (0, 1)	955
n3-21 (0579)	HSB Current Suppression Level	<p>V/f CL-V/f OLV CLV AOLV OLV/PM AOLV/PM CLV/PM EZOLV</p> <p>Sets the upper limit of the current that is suppressed at the time of overexcitation deceleration as a percentage of the drive rated current.</p>	100% (0 - 150%)	955
n3-23 (057B)	Overexcitation Braking Operation	<p>V/f CL-V/f OLV CLV AOLV OLV/PM AOLV/PM CLV/PM EZOLV</p> <p>Sets the direction of motor rotation where the drive will enable overexcitation.</p> <p>0 : Disabled 1 : Enabled Only when Rotating FWD 2 : Enabled Only when Rotating REV</p>	0 (0 - 2)	955

◆ n4: Adv Open Loop Vector Tune

No. (Hex.)	Name	Description	Default (Range)	Ref.
n4-60 (1B80)	Motoring Low Speed Comp Gain	<input type="checkbox"/> V/f <input type="checkbox"/> CL-V/f <input type="checkbox"/> OLV <input type="checkbox"/> CLV <input checked="" type="checkbox"/> AOLV <input type="checkbox"/> OLV/PM <input type="checkbox"/> AOLV/PM <input type="checkbox"/> CLV/PM <input type="checkbox"/> EZOLV Sets a compensation gain to improve the control qualities for motoring loads in the low speed range.	100.0% (50.0 - 200.0%)	956
n4-61 (1B81)	Low Speed Comp Frequency Level	<input type="checkbox"/> V/f <input type="checkbox"/> CL-V/f <input type="checkbox"/> OLV <input type="checkbox"/> CLV <input checked="" type="checkbox"/> AOLV <input type="checkbox"/> OLV/PM <input type="checkbox"/> AOLV/PM <input type="checkbox"/> CLV/PM <input type="checkbox"/> EZOLV Sets a frequency at which the settings <i>n4-60 [Motoring Low Speed Comp Gain]</i> and <i>n4-62 [Regen Low Speed Comp Gain]</i> are enabled. When the output frequency < <i>n4-61</i> , the drive adjusts the torque to agree with the settings for <i>n4-60</i> and <i>n4-62</i> . Usually it is not necessary to change this setting.	6.00 Hz (0.50 - 12.00 Hz)	956
n4-62 (1B82)	Regen Low Speed Comp Gain	<input type="checkbox"/> V/f <input type="checkbox"/> CL-V/f <input type="checkbox"/> OLV <input type="checkbox"/> CLV <input checked="" type="checkbox"/> AOLV <input type="checkbox"/> OLV/PM <input type="checkbox"/> AOLV/PM <input type="checkbox"/> CLV/PM <input type="checkbox"/> EZOLV Sets a compensation gain to improve the control qualities for regenerative loads in the low speed range.	100.0 (50.0 - 500.0)	956
n4-63 (1B83)	Speed EstimateResponse@High Freq	<input type="checkbox"/> V/f <input type="checkbox"/> CL-V/f <input type="checkbox"/> OLV <input type="checkbox"/> CLV <input checked="" type="checkbox"/> AOLV <input type="checkbox"/> OLV/PM <input type="checkbox"/> AOLV/PM <input type="checkbox"/> CLV/PM <input type="checkbox"/> EZOLV Sets the responsiveness of the speed estimation in high speed ranges, where the output frequency is \geq <i>n4-67 [Estimate Gain Switchover Freq]</i> .	60.0 (0.1 - 300.0)	956
n4-64 (1B84)	Speed Estimate Response@Low Freq	<input type="checkbox"/> V/f <input type="checkbox"/> CL-V/f <input type="checkbox"/> OLV <input type="checkbox"/> CLV <input checked="" type="checkbox"/> AOLV <input type="checkbox"/> OLV/PM <input type="checkbox"/> AOLV/PM <input type="checkbox"/> CLV/PM <input type="checkbox"/> EZOLV Sets the responsiveness of the speed estimation in low speed ranges, where $0 \leq$ the output frequency, which is < <i>n4-67 [Estimate Gain Switchover Freq]</i> .	60.0 (0.1 - 300.0)	957
n4-65 (1B85)	Flux Estimate Response@High Freq	<input type="checkbox"/> V/f <input type="checkbox"/> CL-V/f <input type="checkbox"/> OLV <input checked="" type="checkbox"/> CLV <input checked="" type="checkbox"/> AOLV <input type="checkbox"/> OLV/PM <input type="checkbox"/> AOLV/PM <input type="checkbox"/> CLV/PM <input type="checkbox"/> EZOLV Sets the responsiveness of the magnetic flux estimation in high speed ranges, where the output frequency is \geq <i>n4-67 [Estimate Gain Switchover Freq]</i> . Usually it is not necessary to change this setting.	1.00 (0.50 - 3.00)	957
n4-66 (1B86)	Flux Estimate Response @Low Freq	<input type="checkbox"/> V/f <input type="checkbox"/> CL-V/f <input type="checkbox"/> OLV <input checked="" type="checkbox"/> CLV <input checked="" type="checkbox"/> AOLV <input type="checkbox"/> OLV/PM <input type="checkbox"/> AOLV/PM <input type="checkbox"/> CLV/PM <input type="checkbox"/> EZOLV Sets the responsiveness of the magnetic flux estimation in low speed ranges, where $0 \leq$ the output frequency, which is < <i>n4-67 [Estimate Gain Switchover Freq]</i> . Usually it is not necessary to change this setting.	1.50 (0.50 - 3.00)	957
n4-67 (1B87)	Estimate Gain Switchover Freq	<input type="checkbox"/> V/f <input type="checkbox"/> CL-V/f <input type="checkbox"/> OLV <input checked="" type="checkbox"/> CLV <input checked="" type="checkbox"/> AOLV <input type="checkbox"/> OLV/PM <input type="checkbox"/> AOLV/PM <input type="checkbox"/> CLV/PM <input type="checkbox"/> EZOLV Sets the switching frequency for estimation gain for these parameters: <i>n4-63 [Speed EstimateResponse@High Freq]</i> <i>n4-64 [Speed Estimate Response@Low Freq]</i> <i>n4-65 [Flux Estimate Response@High Freq]</i> <i>n4-66 [Flux Estimate Response @Low Freq]</i> Usually it is not necessary to change this setting.	6.00 Hz (0.00 - E1-04 setting)	957
n4-68 (1B88)	Speed Estimation Filter Time	<input type="checkbox"/> V/f <input type="checkbox"/> CL-V/f <input type="checkbox"/> OLV <input type="checkbox"/> CLV <input checked="" type="checkbox"/> AOLV <input type="checkbox"/> OLV/PM <input type="checkbox"/> AOLV/PM <input type="checkbox"/> CLV/PM <input type="checkbox"/> EZOLV Sets the primary delay time constant for the speed estimation value. Usually it is not necessary to change this setting.	0.001 s (0.001 - 0.010 s)	957
n4-69 (1B89)	Flux Control Response	<input type="checkbox"/> V/f <input type="checkbox"/> CL-V/f <input type="checkbox"/> OLV <input type="checkbox"/> CLV <input checked="" type="checkbox"/> AOLV <input type="checkbox"/> OLV/PM <input type="checkbox"/> AOLV/PM <input type="checkbox"/> CLV/PM <input type="checkbox"/> EZOLV Unifies control of magnetic flux to make motor vibrations more stable.	1.00 (0.00 - 60.00)	958
n4-70 (1B8A)	Speed Command Comp @ Low Freq	<input type="checkbox"/> V/f <input type="checkbox"/> CL-V/f <input type="checkbox"/> OLV <input type="checkbox"/> CLV <input checked="" type="checkbox"/> AOLV <input type="checkbox"/> OLV/PM <input type="checkbox"/> AOLV/PM <input type="checkbox"/> CLV/PM <input type="checkbox"/> EZOLV Sets the function to make the drive more stable when operating at low speeds. Usually it is not necessary to change this setting.	1.00 Hz (0.00 - 6.00 Hz)	958
n4-71 (1B8B) Expert	Flux Estimation Method	<input type="checkbox"/> V/f <input type="checkbox"/> CL-V/f <input type="checkbox"/> OLV <input type="checkbox"/> CLV <input checked="" type="checkbox"/> AOLV <input type="checkbox"/> OLV/PM <input type="checkbox"/> AOLV/PM <input type="checkbox"/> CLV/PM <input type="checkbox"/> EZOLV Sets the flux estimation method. Usually it is not necessary to change this setting. 0 : Method 1 1 : Method 2	0 (0, 1)	958
n4-72 (1B8C)	Speed Feedback Mode	<input type="checkbox"/> V/f <input type="checkbox"/> CL-V/f <input type="checkbox"/> OLV <input type="checkbox"/> CLV <input checked="" type="checkbox"/> AOLV <input type="checkbox"/> OLV/PM <input type="checkbox"/> AOLV/PM <input type="checkbox"/> CLV/PM <input type="checkbox"/> EZOLV Sets the requirement for an encoder option when <i>A1-02 = 4 [Control Method Selection = Advanced Open Loop Vector]</i> . 0 : Without Encoder 1 : With Encoder	0 (0, 1)	958
n4-73 (1B8D)	PGo Recovery Selection	<input type="checkbox"/> V/f <input type="checkbox"/> CL-V/f <input type="checkbox"/> OLV <input type="checkbox"/> CLV <input checked="" type="checkbox"/> AOLV <input type="checkbox"/> OLV/PM <input type="checkbox"/> AOLV/PM <input type="checkbox"/> CLV/PM <input type="checkbox"/> EZOLV Sets the restart mode to Without Encoder Mode or the With Encoder Mode when an encoder is disconnected. 0 : Without Encoder 1 : With Encoder	0 (0, 1)	958
n4-74 (1B8E)	Limit of Flux Loop	<input type="checkbox"/> V/f <input type="checkbox"/> CL-V/f <input type="checkbox"/> OLV <input type="checkbox"/> CLV <input checked="" type="checkbox"/> AOLV <input type="checkbox"/> OLV/PM <input type="checkbox"/> AOLV/PM <input type="checkbox"/> CLV/PM <input type="checkbox"/> EZOLV Sets the control level for flux loop control output.	250% (100 - 500%)	959

◆ n5: Feed Forward Control

No. (Hex.)	Name	Description	Default (Range)	Ref.
n5-01 (05B0)	Feed Forward Control Selection	<p>V/f CL-V/f OLV CLV AOLV OLV/PM AOLV/PM CLV/PM EZOLV</p> <p>Sets the feed forward function. 0 : Disabled 1 : Enabled</p>	0 (0, 1)	960
n5-02 (05B1)	Motor Inertia Acceleration Time	<p>V/f CL-V/f OLV CLV AOLV OLV/PM AOLV/PM CLV/PM EZOLV</p> <p>Sets the length of time for the motor to accelerate from the stopped to the maximum frequency with a single motor at the rated torque. Inertia Tuning automatically sets the motor acceleration time.</p>	Determined by C6-01, E5-01, and o2-04 (0.001 - 10.000 s)	960
n5-03 (05B2)	Feed Forward Control Gain	<p>V/f CL-V/f OLV CLV AOLV OLV/PM AOLV/PM CLV/PM EZOLV</p> <p>Sets the ratio between load inertia and motor inertia. Inertia Tuning automatically sets the Feedforward Control Gain value.</p>	1.00 (0.00 - 100.00)	961
n5-04 (05B3) RUN Expert	Speed Response Frequency	<p>V/f CL-V/f OLV CLV AOLV OLV/PM AOLV/PM CLV/PM EZOLV</p> <p>Sets the response frequency for the speed reference. Usually it is not necessary to change this parameter.</p>	Determined by A1-02 (0.00 - 500.00 Hz)	962

◆ n6: Online Tuning

No. (Hex.)	Name	Description	Default (Range)	Ref.
n6-01 (0570)	Online Tuning Selection	<p>V/f CL-V/f OLV CLV AOLV OLV/PM AOLV/PM CLV/PM EZOLV</p> <p>Sets the type of motor data that Online Tuning uses for OLV control. 0 : Disabled 1 : Line-to-Line Resistance Tuning 2 : Voltage Correction Tuning</p>	0 (0 - 2)	962
n6-05 (05C7) Expert	Online Tuning Gain	<p>V/f CL-V/f OLV CLV AOLV OLV/PM AOLV/PM CLV/PM EZOLV</p> <p>Sets the compensation gain when n6-01 = 2 [Online Tuning Selection = Voltage Correction Tuning]. Usually it is not necessary to change this parameter.</p>	1.0 (0.1 - 50.0)	962
n6-11 (1B56) Expert	Online Resistance Tuning	<p>V/f CL-V/f OLV CLV AOLV OLV/PM AOLV/PM CLV/PM EZOLV</p> <p>Sets the responsiveness for online resistor tuning. Set this parameter to approximately 1.000 to enable the function. The function is disabled when the value is 0.000.</p>	0.000 (0.000 - 1.000)	962

◆ n7: EZ Drive

No. (Hex.)	Name	Description	Default (Range)	Ref.
n7-01 (3111) Expert	Damping Gain for Low Frequency	<p>V/f CL-V/f OLV CLV AOLV OLV/PM AOLV/PM CLV/PM EZOLV</p> <p>Sets the oscillation suppression gain for the low speed range.</p>	1.0 (0.1 - 10.0)	963
n7-05 (3115) Expert	Response Gain for Load Changes	<p>V/f CL-V/f OLV CLV AOLV OLV/PM AOLV/PM CLV/PM EZOLV</p> <p>Sets the response gain related to changes in the load.</p>	100 (10 - 1000)	963
n7-07 (3117) Expert	Speed Calculation Gain1	<p>V/f CL-V/f OLV CLV AOLV OLV/PM AOLV/PM CLV/PM EZOLV</p> <p>Sets the speed calculation gain during usual operation. Usually it is not necessary to change this setting.</p>	15.0 Hz (1.0 - 50.0 Hz)	963
n7-08 (3118) Expert	Speed Calculation Gain2	<p>V/f CL-V/f OLV CLV AOLV OLV/PM AOLV/PM CLV/PM EZOLV</p> <p>Sets the speed calculation gain during a speed search.</p>	25.0 Hz (1.0 - 50.0 Hz)	963
n7-10 (311A) Expert	Pull-in Current Switching Speed	<p>V/f CL-V/f OLV CLV AOLV OLV/PM AOLV/PM CLV/PM EZOLV</p> <p>Parameter n8-51 [Pull-in Current @ Acceleration], is in effect when the output frequency is \leq n7-10, where the speed is set as a percentage of rated speed.</p> <p>Note:</p> <ul style="list-style-type: none"> The value set in n8-51 [Pull-in Current @ Acceleration] is enabled for speeds that are not higher than n7-10 during deceleration. The value set in b8-01 [Energy Saving Control Selection] is enabled for speeds higher than n7-10. If there is a large quantity of oscillation when you operate in the low speed range, increase the setting value. When it is most important to save energy in the low speed range, decrease the setting value. 	10.0% (0.0 - 100.0%)	963

No. (Hex.)	Name	Description	Default (Range)	Ref.
n7-11 (311B) Expert	Pull-in Current Switch Hysteresis Band	<p><input type="checkbox"/> V/f <input type="checkbox"/> CL-V/f <input type="checkbox"/> OLV <input type="checkbox"/> CLV <input type="checkbox"/> AOLV <input type="checkbox"/> OLV/PM <input type="checkbox"/> AOLV/PM <input type="checkbox"/> CLV/PM <input checked="" type="checkbox"/> EZOLV</p> <p>Sets the hysteresis level for Switching Speed set in n7-10 [Pull-in Current Switching Speed]. When the speed is lower than n7-10 + n7-11 during acceleration, the drive enables pull-in current.</p> <p>Note:</p> <ul style="list-style-type: none"> The value set in n8-51 [Pull-in Current @ Acceleration] is enabled for speeds that are not higher than n7-10 + n7-11 during acceleration. The value set in b8-01 [Energy Saving Control Selection] is enabled for speeds higher than n7-10 + n7-11. If there is a large quantity of oscillation when you operate in the low speed range, increase the setting value. When it is most important to save energy in the low speed range, decrease the setting value. 	5.0% (1.0 - 20.0%)	964
n7-13 (311D) Expert	Pull-in Current Switching Time	<p><input type="checkbox"/> V/f <input type="checkbox"/> CL-V/f <input type="checkbox"/> OLV <input type="checkbox"/> CLV <input type="checkbox"/> AOLV <input type="checkbox"/> OLV/PM <input type="checkbox"/> AOLV/PM <input type="checkbox"/> CLV/PM <input checked="" type="checkbox"/> EZOLV</p> <p>Sets a time to enable the pull-in current commands.</p> <p>If there is a large quantity of oscillation at speeds around n7-10 [Pull-in Current Switching Speed], decrease the setting in decrements of 20 ms.</p>	100 ms (0 - 1000 ms)	964
n7-17 (3122)	Resistance Temperature Correction	<p><input type="checkbox"/> V/f <input type="checkbox"/> CL-V/f <input type="checkbox"/> OLV <input type="checkbox"/> CLV <input type="checkbox"/> AOLV <input type="checkbox"/> OLV/PM <input type="checkbox"/> AOLV/PM <input type="checkbox"/> CLV/PM <input checked="" type="checkbox"/> EZOLV</p> <p>Sets the function to adjust for changes in the motor resistance value caused by changes in the temperature.</p> <p>0 : Invalid 1 : Valid (Only 1 time) 2 : Valid (Every time)</p>	1 (0 to 2)	964

◆ n8: PM Motor Control Tuning

No. (Hex.)	Name	Description	Default (Range)	Ref.
n8-01 (0540)	Pole Position Detection Current	<p><input type="checkbox"/> V/f <input type="checkbox"/> CL-V/f <input type="checkbox"/> OLV <input type="checkbox"/> CLV <input type="checkbox"/> AOLV <input checked="" type="checkbox"/> OLV/PM <input checked="" type="checkbox"/> AOLV/PM <input checked="" type="checkbox"/> CLV/PM <input type="checkbox"/> EZOLV</p> <p>Sets, as a percentage, the Initial Rotor Position Estimated Current, taking the E5-03 [Motor Rated Current (FLA)] as the 100% value. Usually it is not necessary to change this setting.</p>	50% (0 - 100%)	964
n8-02 (0541) Expert	Pole Alignment Current Level	<p><input type="checkbox"/> V/f <input type="checkbox"/> CL-V/f <input type="checkbox"/> OLV <input type="checkbox"/> CLV <input type="checkbox"/> AOLV <input type="checkbox"/> OLV/PM <input type="checkbox"/> AOLV/PM <input type="checkbox"/> CLV/PM <input checked="" type="checkbox"/> EZOLV</p> <p>Sets the current at the time of polar attraction as a percentage of E5-03 [Motor Rated Current (FLA)]. Usually it is not necessary to change this setting.</p>	80% (0 - 150%)	965
n8-03 (0542)	Pole Position Detection Time	<p><input type="checkbox"/> V/f <input type="checkbox"/> CL-V/f <input type="checkbox"/> OLV <input type="checkbox"/> CLV <input type="checkbox"/> AOLV <input type="checkbox"/> OLV/PM <input type="checkbox"/> AOLV/PM <input checked="" type="checkbox"/> CLV/PM <input type="checkbox"/> EZOLV</p> <p>Sets the length of the Current Starting Time, which is used for Z Pulse Offset Tuning. Usually it is not necessary to change this setting.</p>	1.5 s (1.5 - 5.0 s)	965
n8-04 (0543) Expert	Pole Alignment Time	<p><input type="checkbox"/> V/f <input type="checkbox"/> CL-V/f <input type="checkbox"/> OLV <input type="checkbox"/> CLV <input type="checkbox"/> AOLV <input type="checkbox"/> OLV/PM <input type="checkbox"/> AOLV/PM <input checked="" type="checkbox"/> CLV/PM <input type="checkbox"/> EZOLV</p> <p>Sets the length of the Polar Attraction Time, which is used for Z Pulse Offset Tuning. Usually it is not necessary to change this setting.</p>	1.5 s (1.5 - 5.0 s)	965
n8-11 (054A)	Observer Calculation Gain 2	<p><input type="checkbox"/> V/f <input type="checkbox"/> CL-V/f <input type="checkbox"/> OLV <input type="checkbox"/> CLV <input type="checkbox"/> AOLV <input type="checkbox"/> OLV/PM <input checked="" type="checkbox"/> AOLV/PM <input checked="" type="checkbox"/> CLV/PM <input type="checkbox"/> EZOLV</p> <p>Sets the gain for speed estimation. Usually it is not necessary to change this setting.</p>	Determined by n8-72 (0.0 - 1000.0)	965
n8-14 (054D) Expert	Polarity Compensation Gain 3	<p><input type="checkbox"/> V/f <input type="checkbox"/> CL-V/f <input type="checkbox"/> OLV <input type="checkbox"/> CLV <input type="checkbox"/> AOLV <input type="checkbox"/> OLV/PM <input type="checkbox"/> AOLV/PM <input type="checkbox"/> CLV/PM <input checked="" type="checkbox"/> EZOLV</p> <p>Sets the gain for speed estimation. Usually it is not necessary to change this setting.</p>	1.000 (0.000 - 10.000)	965
n8-15 (054E) Expert	Polarity Compensation Gain 4	<p><input type="checkbox"/> V/f <input type="checkbox"/> CL-V/f <input type="checkbox"/> OLV <input type="checkbox"/> CLV <input type="checkbox"/> AOLV <input type="checkbox"/> OLV/PM <input checked="" type="checkbox"/> AOLV/PM <input type="checkbox"/> CLV/PM <input type="checkbox"/> EZOLV</p> <p>Sets the gain for speed estimation. Usually it is not necessary to change this setting.</p>	0.500 (0.000 - 10.000)	966
n8-21 (0554) Expert	Motor Back-EMF (Ke) Gain	<p><input type="checkbox"/> V/f <input type="checkbox"/> CL-V/f <input type="checkbox"/> OLV <input type="checkbox"/> CLV <input type="checkbox"/> AOLV <input type="checkbox"/> OLV/PM <input checked="" type="checkbox"/> AOLV/PM <input type="checkbox"/> CLV/PM <input type="checkbox"/> EZOLV</p> <p>Sets the gain for speed estimation. Usually it is not necessary to change this setting.</p>	0.90 (0.80 - 1.00)	966
n8-23 (0556) Expert	ACR q Gain @PoleEst	<p><input type="checkbox"/> V/f <input type="checkbox"/> CL-V/f <input type="checkbox"/> OLV <input type="checkbox"/> CLV <input type="checkbox"/> AOLV <input checked="" type="checkbox"/> OLV/PM <input type="checkbox"/> AOLV/PM <input type="checkbox"/> CLV/PM <input type="checkbox"/> EZOLV</p> <p>Sets the proportional gain for current regulator q-axis control when the drive estimates the initial pole. Usually it is not necessary to change this setting.</p>	0 (0 - 2000)	966
n8-24 (0557) Expert	ACR q Integral Time @PoleEst	<p><input type="checkbox"/> V/f <input type="checkbox"/> CL-V/f <input type="checkbox"/> OLV <input type="checkbox"/> CLV <input type="checkbox"/> AOLV <input checked="" type="checkbox"/> OLV/PM <input type="checkbox"/> AOLV/PM <input type="checkbox"/> CLV/PM <input type="checkbox"/> EZOLV</p> <p>Sets the integral time for current regulator q-axis control when the drive estimates the initial pole. Usually it is not necessary to change this setting.</p>	0.0 ms (0.0 - 100.0 ms)	966
n8-25 (0558) Expert	ACR q Limit @PoleEst	<p><input type="checkbox"/> V/f <input type="checkbox"/> CL-V/f <input type="checkbox"/> OLV <input type="checkbox"/> CLV <input type="checkbox"/> AOLV <input checked="" type="checkbox"/> OLV/PM <input type="checkbox"/> AOLV/PM <input type="checkbox"/> CLV/PM <input type="checkbox"/> EZOLV</p> <p>Sets the q-axis limit of the current regulator when the drive estimates the initial pole. Usually it is not necessary to change this setting.</p>	0% (0 - 150%)	966

11.12 n: Special Adjustment

No. (Hex.)	Name	Description	Default (Range)	Ref.
n8-26 (0559) Expert	ACR d Gain @PoleEst	<input type="checkbox"/> V/f <input type="checkbox"/> CL-V/f <input type="checkbox"/> OLV <input type="checkbox"/> CLV <input type="checkbox"/> AOLV <input checked="" type="checkbox"/> OLV/PM <input type="checkbox"/> AOLV/PM <input type="checkbox"/> CLV/PM <input type="checkbox"/> EZOLV Sets the proportional gain for current regulator d-axis control when the drive estimates the initial pole. Usually it is not necessary to change this setting.	500 (0 - 2000)	966
n8-27 (055A) Expert	ACR d Integral Time @PoleEst	<input type="checkbox"/> V/f <input type="checkbox"/> CL-V/f <input type="checkbox"/> OLV <input type="checkbox"/> CLV <input type="checkbox"/> AOLV <input checked="" type="checkbox"/> OLV/PM <input type="checkbox"/> AOLV/PM <input type="checkbox"/> CLV/PM <input type="checkbox"/> EZOLV Sets the integral time for current regulator d-axis control when the drive estimates the initial pole. Usually it is not necessary to change this setting.	0.0 ms (0.0 - 100.0 ms)	966
n8-28 (055B) Expert	ACR d Lim @PoleEst	<input type="checkbox"/> V/f <input type="checkbox"/> CL-V/f <input type="checkbox"/> OLV <input type="checkbox"/> CLV <input type="checkbox"/> AOLV <input checked="" type="checkbox"/> OLV/PM <input type="checkbox"/> AOLV/PM <input type="checkbox"/> CLV/PM <input type="checkbox"/> EZOLV Sets the d-axis limit of the current regulator when the drive estimates the initial pole. Usually it is not necessary to change this setting.	100% (0 - 150%)	967
n8-35 (0562)	Initial Pole Detection Method	<input type="checkbox"/> V/f <input type="checkbox"/> CL-V/f <input type="checkbox"/> OLV <input type="checkbox"/> CLV <input type="checkbox"/> AOLV <input checked="" type="checkbox"/> OLV/PM <input type="checkbox"/> AOLV/PM <input type="checkbox"/> CLV/PM <input type="checkbox"/> EZOLV Sets how the drive detects the position of the rotor at start. Note: • When you operate an SPM motor, set $n8-35 = 0$. When you operate an IPM motor, you can set $n8-35 = 0$ to 2 . • When you set $n8-35 = 1$, do High Frequency Injection Auto-Tuning. 0 : Pull-in 1 : High Frequency Injection 2 : Pulse Injection	Determined by A1-02 (0 - 2)	967
n8-36 (0563)	HFI Frequency Level for L Tuning	<input type="checkbox"/> V/f <input type="checkbox"/> CL-V/f <input type="checkbox"/> OLV <input type="checkbox"/> CLV <input type="checkbox"/> AOLV <input checked="" type="checkbox"/> OLV/PM <input type="checkbox"/> AOLV/PM <input type="checkbox"/> CLV/PM <input type="checkbox"/> EZOLV Sets the injection frequency for high frequency injection. Note: • Set $n8-35 = 1$ [Initial Pole Detection Method = High Frequency Injection] or $n8-57 = 1$ [HFI Overlap Selection = Enabled] to enable this parameter. • The drive automatically calculates this value when High Frequency Injection Auto-Tuning completes successfully.	500 Hz (200 - 1000 Hz)	967
n8-37 (0564) Expert	HFI Voltage Amplitude Level	<input type="checkbox"/> V/f <input type="checkbox"/> CL-V/f <input type="checkbox"/> OLV <input type="checkbox"/> CLV <input type="checkbox"/> AOLV <input checked="" type="checkbox"/> OLV/PM <input type="checkbox"/> AOLV/PM <input type="checkbox"/> CLV/PM <input type="checkbox"/> EZOLV Sets the high frequency injection amplitude as a percentage where 200 V = 100% for 200 V class drives and 400 V = 100% for a 400 V class drives. Usually it is not necessary to change this setting. Note: • Set $n8-35 = 1$ [Initial Pole Detection Method = High Frequency Injection] or $n8-57 = 1$ [HFI Overlap Selection = Enabled] to enable this parameter. • The drive automatically calculates this value when High Frequency Injection Auto-Tuning completes successfully.	20.0% (0.0 - 50.0%)	967
n8-39 (0566)	PM Phase Compensation Gain	<input type="checkbox"/> V/f <input type="checkbox"/> CL-V/f <input type="checkbox"/> OLV <input type="checkbox"/> CLV <input type="checkbox"/> AOLV <input checked="" type="checkbox"/> OLV/PM <input type="checkbox"/> AOLV/PM <input type="checkbox"/> CLV/PM <input type="checkbox"/> EZOLV Sets the low-pass filter shut-off frequency for high frequency injection. Note: • Set $n8-35 = 1$ [Initial Pole Detection Method = High Frequency Injection] or $n8-57 = 1$ [HFI Overlap Selection = Enabled] to enable this parameter. • The drive automatically calculates this value when High Frequency Injection Auto-Tuning completes successfully.	250 Hz (0 - 1000 Hz)	968
n8-41 (0568) Expert	HFI P Gain	<input type="checkbox"/> V/f <input type="checkbox"/> CL-V/f <input type="checkbox"/> OLV <input type="checkbox"/> CLV <input type="checkbox"/> AOLV <input checked="" type="checkbox"/> OLV/PM <input type="checkbox"/> AOLV/PM <input type="checkbox"/> CLV/PM <input type="checkbox"/> EZOLV Sets the response gain for the high frequency injection speed estimation.	2.5 (-10.0 - +10.0)	968
n8-42 (0569) Expert	HFI I Time	<input type="checkbox"/> V/f <input type="checkbox"/> CL-V/f <input type="checkbox"/> OLV <input type="checkbox"/> CLV <input type="checkbox"/> AOLV <input checked="" type="checkbox"/> OLV/PM <input type="checkbox"/> AOLV/PM <input type="checkbox"/> CLV/PM <input type="checkbox"/> EZOLV Sets the integral time constant for the high frequency injection speed estimation. Usually it is not necessary to change this setting.	0.10 s (0.00 - 9.99 s)	968
n8-45 (0538)	Speed Feedback Detection Gain	<input type="checkbox"/> V/f <input type="checkbox"/> CL-V/f <input type="checkbox"/> OLV <input type="checkbox"/> CLV <input type="checkbox"/> AOLV <input checked="" type="checkbox"/> OLV/PM <input type="checkbox"/> AOLV/PM <input type="checkbox"/> CLV/PM <input type="checkbox"/> EZOLV Sets the internal speed feedback detection reduction unit gain as a magnification value. Usually it is not necessary to change this setting.	0.80 (0.00 - 10.00)	968
n8-46 (0539) Expert	PM Phase Compensation Gain	<input type="checkbox"/> V/f <input type="checkbox"/> CL-V/f <input type="checkbox"/> OLV <input type="checkbox"/> CLV <input type="checkbox"/> AOLV <input checked="" type="checkbox"/> OLV/PM <input type="checkbox"/> AOLV/PM <input type="checkbox"/> CLV/PM <input type="checkbox"/> EZOLV Sets the gain to compensate for phase differences. Usually it is not necessary to change this setting.	0.3 (0.0 - 10.0)	968
n8-47 (053A)	Pull-in Current Comp Filter Time	<input type="checkbox"/> V/f <input type="checkbox"/> CL-V/f <input type="checkbox"/> OLV <input type="checkbox"/> CLV <input type="checkbox"/> AOLV <input checked="" type="checkbox"/> OLV/PM <input type="checkbox"/> AOLV/PM <input type="checkbox"/> CLV/PM <input type="checkbox"/> EZOLV Sets the time constant the drive uses to align the pull-in current reference value with the actual current value. Usually it is not necessary to change this setting.	5.0 s (0.0 - 100.0 s)	969
n8-48 (053B)	Pull-in/Light Load Id Current	<input type="checkbox"/> V/f <input type="checkbox"/> CL-V/f <input type="checkbox"/> OLV <input type="checkbox"/> CLV <input type="checkbox"/> AOLV <input checked="" type="checkbox"/> OLV/PM <input type="checkbox"/> AOLV/PM <input type="checkbox"/> CLV/PM <input type="checkbox"/> EZOLV On the basis that parameter $E5-03$ [Motor Rated Current (FLA)] is the 100% value, this parameter sets the d-axis current that flows to the motor during run at constant speed as a percentage.	30% (0 - 200%)	969
n8-49 (053C)	Heavy Load Id Current	<input type="checkbox"/> V/f <input type="checkbox"/> CL-V/f <input type="checkbox"/> OLV <input type="checkbox"/> CLV <input type="checkbox"/> AOLV <input checked="" type="checkbox"/> OLV/PM <input type="checkbox"/> AOLV/PM <input type="checkbox"/> CLV/PM <input type="checkbox"/> EZOLV Sets the d-axis current to that the drive will supply to the motor to run it at a constant speed with a heavy load. Considers $E5-03$ [PM Motor Rated Current (FLA)] to be 100%. Usually it is not necessary to change this setting.	Determined by E5-01 (-200.0 - +200.0%)	969

No. (Hex.)	Name	Description	Default (Range)	Ref.
n8-50 (053D)	Medium Load Iq Level (High)	<input type="checkbox"/> V/f <input type="checkbox"/> CL-V/f <input type="checkbox"/> OLV <input type="checkbox"/> CLV <input type="checkbox"/> AOLV <input checked="" type="checkbox"/> OLV/PM <input type="checkbox"/> AOLV/PM <input type="checkbox"/> CLV/PM <input type="checkbox"/> EZOLV Sets the load current level to start high efficiency control as a percentage of <i>E5-03 [PM Motor Rated Current (FLA)]</i> . Usually it is not necessary to change this setting.	80% (50 - 255%)	969
n8-51 (053E)	Pull-in Current @ Acceleration	<input type="checkbox"/> V/f <input type="checkbox"/> CL-V/f <input type="checkbox"/> OLV <input type="checkbox"/> CLV <input type="checkbox"/> AOLV <input checked="" type="checkbox"/> OLV/PM <input type="checkbox"/> AOLV/PM <input type="checkbox"/> CLV/PM <input type="checkbox"/> EZOLV Sets the pull-in current allowed to flow during acceleration/deceleration as a percentage of the motor rated current. Note: Parameter <i>A1-02 [Control Method Selection]</i> selects which parameter is the motor rated current. • <i>A1-02 = 5 [OLV/PM]: E5-03 [Motor Rated Current (FLA)]</i> • <i>A1-02 = 8 [EZOLV]: E9-06 [Motor Rated Current (FLA)]</i>	Determined by A1-02 (0 - 200%)	969
n8-52 (053F) Expert	ACR P Gain	<input type="checkbox"/> V/f <input type="checkbox"/> CL-V/f <input type="checkbox"/> OLV <input type="checkbox"/> CLV <input type="checkbox"/> AOLV <input checked="" type="checkbox"/> OLV/PM <input type="checkbox"/> AOLV/PM <input type="checkbox"/> CLV/PM <input type="checkbox"/> EZOLV Sets the proportional gain of the current regulator. Usually it is not necessary to change this setting.	10.0 (-100.0 - 100.0)	970
n8-54 (056D) Expert	Voltage Error Compensation Time	<input type="checkbox"/> V/f <input type="checkbox"/> CL-V/f <input type="checkbox"/> OLV <input type="checkbox"/> CLV <input type="checkbox"/> AOLV <input checked="" type="checkbox"/> OLV/PM <input type="checkbox"/> AOLV/PM <input type="checkbox"/> CLV/PM <input type="checkbox"/> EZOLV Sets the time constant that the drive uses when adjusting for voltage errors.	1.00 s (0.00 - 10.00 s)	970
n8-55 (056E)	Motor to Load Inertia Ratio	<input type="checkbox"/> V/f <input type="checkbox"/> CL-V/f <input type="checkbox"/> OLV <input type="checkbox"/> CLV <input type="checkbox"/> AOLV <input checked="" type="checkbox"/> OLV/PM <input type="checkbox"/> AOLV/PM <input type="checkbox"/> CLV/PM <input type="checkbox"/> EZOLV Sets the ratio between motor inertia and machine inertia. 0 : Below 1:10 1 : Between 1:10 and 1:30 2 : Between 1:30 and 1:50 3 : Beyond 1:50	0 (0 - 3)	970
n8-56 (056F) Expert	PM High Performance Selection	<input type="checkbox"/> V/f <input type="checkbox"/> CL-V/f <input type="checkbox"/> OLV <input type="checkbox"/> CLV <input type="checkbox"/> AOLV <input checked="" type="checkbox"/> OLV/PM <input type="checkbox"/> AOLV/PM <input type="checkbox"/> CLV/PM <input type="checkbox"/> EZOLV Usually it is not necessary to change this setting. Sets the high efficiency control method for IPM motor. 0 : Disabled 1 : Enabled (Vd) 2 : Enabled (Vd & Vq)	1 (0 - 2)	971
n8-57 (0574)	HFI Overlap Selection	<input type="checkbox"/> V/f <input type="checkbox"/> CL-V/f <input type="checkbox"/> OLV <input type="checkbox"/> CLV <input type="checkbox"/> AOLV <input type="checkbox"/> OLV/PM <input checked="" type="checkbox"/> AOLV/PM <input type="checkbox"/> CLV/PM <input type="checkbox"/> EZOLV Sets the function that detects motor speed with high frequency injection. Note: When you set <i>n8-57 = 1</i> , doHigh Frequency Injection Auto-Tuning. 0 : Disabled 1 : Enabled	0 (0, 1)	971
n8-62 (057D) Expert	Output Voltage Limit Level	<input type="checkbox"/> V/f <input type="checkbox"/> CL-V/f <input type="checkbox"/> OLV <input type="checkbox"/> CLV <input type="checkbox"/> AOLV <input checked="" type="checkbox"/> OLV/PM <input type="checkbox"/> AOLV/PM <input type="checkbox"/> CLV/PM <input type="checkbox"/> EZOLV Sets the output voltage limit to prevent saturation of the output voltage. Usually it is not necessary to change this parameter. Note: • When <i>A1-02 = 7, 8 [Control Method Selection = CLV/PM, EZOLV]</i> , this parameter is available in Expert Mode. • When <i>A1-02 = 8</i> , the default setting is –200 V Class: 230.0 V –400 V Class: 460.0 V	200 V Class: 200.0 V, 400 V Class: 400.0 V (200 V Class: 0.0 to 240.0 V, 400 V Class: 0.0 to 480.0 V)	971
n8-63 (057E) Expert	Output Voltage Limit P Gain	<input type="checkbox"/> V/f <input type="checkbox"/> CL-V/f <input type="checkbox"/> OLV <input type="checkbox"/> CLV <input type="checkbox"/> AOLV <input checked="" type="checkbox"/> OLV/PM <input type="checkbox"/> AOLV/PM <input type="checkbox"/> CLV/PM <input type="checkbox"/> EZOLV Sets the proportional gain for output voltage control. Usually it is not necessary to change this setting.	1.00 (0.00 - 100.00)	971
n8-64 (057F) Expert	Output Voltage Limit I Time	<input type="checkbox"/> V/f <input type="checkbox"/> CL-V/f <input type="checkbox"/> OLV <input type="checkbox"/> CLV <input type="checkbox"/> AOLV <input checked="" type="checkbox"/> OLV/PM <input type="checkbox"/> AOLV/PM <input type="checkbox"/> CLV/PM <input type="checkbox"/> EZOLV Sets the integral time for output voltage control. Usually it is not necessary to change this setting. Usually it is not necessary to change this setting.	0.040 s (0.000 - 5.000)	972
n8-65 (065C) Expert	Speed Fdbk Gain @ oV Suppression	<input type="checkbox"/> V/f <input type="checkbox"/> CL-V/f <input type="checkbox"/> OLV <input type="checkbox"/> CLV <input type="checkbox"/> AOLV <input checked="" type="checkbox"/> OLV/PM <input type="checkbox"/> AOLV/PM <input type="checkbox"/> CLV/PM <input type="checkbox"/> EZOLV Sets the gain of internal speed feedback detection suppression while the overvoltage suppression function is operating as a magnification value. Usually it is not necessary to change this parameter.	1.50 (0.00 - 10.00)	972
n8-66 (0235) Expert	Output Voltage Limit Filter Time	<input type="checkbox"/> V/f <input type="checkbox"/> CL-V/f <input type="checkbox"/> OLV <input type="checkbox"/> CLV <input type="checkbox"/> AOLV <input checked="" type="checkbox"/> OLV/PM <input type="checkbox"/> AOLV/PM <input type="checkbox"/> CLV/PM <input type="checkbox"/> EZOLV Sets the filter time constant for output voltage control. Usually it is not necessary to change this setting.	0.020 s (0.000 - 5.000)	972
n8-69 (065D) Expert	Speed Observer Control P Gain	<input type="checkbox"/> V/f <input type="checkbox"/> CL-V/f <input type="checkbox"/> OLV <input type="checkbox"/> CLV <input type="checkbox"/> AOLV <input type="checkbox"/> OLV/PM <input checked="" type="checkbox"/> AOLV/PM <input type="checkbox"/> CLV/PM <input type="checkbox"/> EZOLV Usually it is not necessary to change this setting. Sets the Proportional gain that the drive uses for speed estimation.	1.00 (0.00 - 20.00)	972
n8-70 (065E) Expert	Speed Observer Control I Time	<input type="checkbox"/> V/f <input type="checkbox"/> CL-V/f <input type="checkbox"/> OLV <input type="checkbox"/> CLV <input type="checkbox"/> AOLV <input type="checkbox"/> OLV/PM <input checked="" type="checkbox"/> AOLV/PM <input type="checkbox"/> CLV/PM <input type="checkbox"/> EZOLV Sets the speed estimator integral time constant. It is available when <i>n8-72 = 1 [Speed Estimation Method Select = Method 2]</i> . Usually it is not necessary to change this setting.	0.0 s (0.0 - 100.0 s)	972

11.12 n: Special Adjustment

No. (Hex.)	Name	Description	Default (Range)	Ref.
n8-71 (065F) Expert	Speed Observer Control D Gain	<input type="checkbox"/> V/f <input type="checkbox"/> CL-V/f <input type="checkbox"/> OLV <input type="checkbox"/> CLV <input type="checkbox"/> AOLV <input type="checkbox"/> OLV/PM <input checked="" type="checkbox"/> AOLV/PM <input type="checkbox"/> CLV/PM <input type="checkbox"/> EZOLV Set the speed estimator differential gain. It is available when $n8-72 = 1$ [Speed Estimation Method Select = Method 2]. Usually it is not necessary to change this setting.	5.00 (0.00 - 50.00)	972
n8-72 (0655) Expert	Speed Estimation Method Select	<input type="checkbox"/> V/f <input type="checkbox"/> CL-V/f <input type="checkbox"/> OLV <input type="checkbox"/> CLV <input type="checkbox"/> AOLV <input type="checkbox"/> OLV/PM <input checked="" type="checkbox"/> AOLV/PM <input type="checkbox"/> CLV/PM <input type="checkbox"/> EZOLV Selects the speed estimation method. Usually it is not necessary to change this setting. 0 : Method 1 1 : Method 2	1 (0, 1)	972
n8-73 (0656) Expert	Observer Mode Switch-Over Speed	<input type="checkbox"/> V/f <input type="checkbox"/> CL-V/f <input type="checkbox"/> OLV <input type="checkbox"/> CLV <input type="checkbox"/> AOLV <input type="checkbox"/> OLV/PM <input checked="" type="checkbox"/> AOLV/PM <input type="checkbox"/> CLV/PM <input type="checkbox"/> EZOLV Sets the speed level for pull-in current control at motor start as a percentage of $E1-06$ [Base Frequency]. Usually it is not necessary to change this setting.	10% (0 - 100%)	973
n8-74 (05C3)	Light Load Iq Level	<input type="checkbox"/> V/f <input type="checkbox"/> CL-V/f <input type="checkbox"/> OLV <input type="checkbox"/> CLV <input type="checkbox"/> AOLV <input checked="" type="checkbox"/> OLV/PM <input type="checkbox"/> AOLV/PM <input type="checkbox"/> CLV/PM <input type="checkbox"/> EZOLV Set $n8-48$ [Pull-in/Light Load Id Current] to the percentage of load current (q-axis current) that you will apply, where $E5-03$ [Motor Rated Current (FLA)] = a setting value of 100%.	30% (0 - 255%)	973
n8-75 (05C4)	Medium Load Iq Level (low)	<input type="checkbox"/> V/f <input type="checkbox"/> CL-V/f <input type="checkbox"/> OLV <input type="checkbox"/> CLV <input type="checkbox"/> AOLV <input checked="" type="checkbox"/> OLV/PM <input type="checkbox"/> AOLV/PM <input type="checkbox"/> CLV/PM <input type="checkbox"/> EZOLV Set $n8-78$ [Medium Load Id Current] to the percentage of load current (q-axis current) that you will apply, where $E5-03$ [Motor Rated Current (FLA)] = a setting value of 100%.	50% (0 - 255%)	973
n8-76 (05CD) Expert	Id Switching Filter Time	<input type="checkbox"/> V/f <input type="checkbox"/> CL-V/f <input type="checkbox"/> OLV <input type="checkbox"/> CLV <input type="checkbox"/> AOLV <input checked="" type="checkbox"/> OLV/PM <input type="checkbox"/> AOLV/PM <input type="checkbox"/> CLV/PM <input type="checkbox"/> EZOLV Sets the filter time constant for d-axis current reference. Usually it is not necessary to change this setting.	200 ms (0 - 5000 ms)	973
n8-77 (05CE)	Heavy Load Iq Level	<input type="checkbox"/> V/f <input type="checkbox"/> CL-V/f <input type="checkbox"/> OLV <input type="checkbox"/> CLV <input type="checkbox"/> AOLV <input checked="" type="checkbox"/> OLV/PM <input type="checkbox"/> AOLV/PM <input type="checkbox"/> CLV/PM <input type="checkbox"/> EZOLV Set $n8-49$ [Heavy Load Id Current] to the percentage of load current (q-axis current) that you will apply, where $E5-03$ [Motor Rated Current (FLA)] = a setting value of 100%.	90% (0 - 255%)	973
n8-78 (05F4)	Medium Load Id Current	<input type="checkbox"/> V/f <input type="checkbox"/> CL-V/f <input type="checkbox"/> OLV <input type="checkbox"/> CLV <input type="checkbox"/> AOLV <input checked="" type="checkbox"/> OLV/PM <input type="checkbox"/> AOLV/PM <input type="checkbox"/> CLV/PM <input type="checkbox"/> EZOLV Sets the level of the pull-in current for mid-range loads.	0% (-200 - +200%)	973
n8-79 (05FE)	Pull-in Current @ Deceleration	<input type="checkbox"/> V/f <input type="checkbox"/> CL-V/f <input type="checkbox"/> OLV <input type="checkbox"/> CLV <input type="checkbox"/> AOLV <input checked="" type="checkbox"/> OLV/PM <input type="checkbox"/> AOLV/PM <input type="checkbox"/> CLV/PM <input type="checkbox"/> EZOLV Sets the pull-in current that can flow during deceleration as a percentage of the $E5-03$ [PM Motor Rated Current (FLA)]. Note: When $n8-79 = 0$, the drive will use the value set in $n8-51$ [Pull-in Current @ Acceleration].	50% (0 - 200%)	974
n8-84 (02D3) Expert	Polarity Detection Current	<input type="checkbox"/> V/f <input type="checkbox"/> CL-V/f <input type="checkbox"/> OLV <input type="checkbox"/> CLV <input type="checkbox"/> AOLV <input checked="" type="checkbox"/> OLV/PM <input type="checkbox"/> AOLV/PM <input type="checkbox"/> CLV/PM <input type="checkbox"/> EZOLV Sets the current for processing an estimation of the initial motor magnetic pole as a percentage, where $E5-03$ [PM Motor Rated Current] is the 100% value.	100% (0 - 150%)	974
n8-94 (012D) Expert	Flux Position Estimation Method	<input type="checkbox"/> V/f <input type="checkbox"/> CL-V/f <input type="checkbox"/> OLV <input type="checkbox"/> CLV <input type="checkbox"/> AOLV <input type="checkbox"/> OLV/PM <input checked="" type="checkbox"/> AOLV/PM <input type="checkbox"/> CLV/PM <input type="checkbox"/> EZOLV Sets the criteria that the drive uses to find changes in speed or load. Usually it is not necessary to change this setting. 0 : Softstarter 1 : Speed Feedback	Determined by d5-01 (0, 1)	974
n8-95 (012E) Expert	Flux Position Est Filter Time	<input type="checkbox"/> V/f <input type="checkbox"/> CL-V/f <input type="checkbox"/> OLV <input type="checkbox"/> CLV <input type="checkbox"/> AOLV <input type="checkbox"/> OLV/PM <input checked="" type="checkbox"/> AOLV/PM <input type="checkbox"/> CLV/PM <input type="checkbox"/> EZOLV Sets the time constant of the filter used for the recognition criteria value for speed and load changes. Usually it is not necessary to change this setting.	30 ms (0 - 100 ms)	974

11.13 o: Keypad-Related Settings

◆ o1: Keypad Display



No. (Hex.)	Name	Description	Default (Range)	Ref.
o1-01 (0500) RUN	User Monitor Selection	V/f CL-V/f OLV CLV AOLV OLV/PM AOLV/PM CLV/PM EZOLV Sets the <i>U</i> monitor for the Drive Mode. This parameter is only available when you use an LED keypad.	106 (104 - 855)	976
o1-02 (0501) RUN	Monitor Selection at Power-up	V/f CL-V/f OLV CLV AOLV OLV/PM AOLV/PM CLV/PM EZOLV Sets the monitor item that the keypad screen shows after energizing the drive. Refer to "U: Monitors" for information about the monitor items that the keypad screen can show. This parameter is only available when you use an LED keypad. 1 : Frequency Reference (U1-01) 2 : Direction 3 : Output Frequency (U1-02) 4 : Output Current (U1-03) 5 : User Monitor (<i>o1-01</i>)	1 (1 - 5)	976
o1-03 (0502)	Frequency Display Unit Selection	V/f CL-V/f OLV CLV AOLV OLV/PM AOLV/PM CLV/PM EZOLV Sets the display units for the frequency reference and output frequency. 0 : 0.01Hz units 1 : 0.01% units 2 : min ⁻¹ (r/min) unit 3 : User Units	Determined by A1-02 (0 - 3)	976
o1-04 (0503)	V/f Pattern Display Unit	V/f CL-V/f OLV CLV AOLV OLV/PM AOLV/PM CLV/PM EZOLV Sets the setting unit for parameters that set the V/f pattern frequency. 0 : Hz 1 : min ⁻¹ (r/min) unit	Determined by A1-02 (0, 1)	977
o1-05 (0504) RUN	LCD Contrast Adjustment	V/f CL-V/f OLV CLV AOLV OLV/PM AOLV/PM CLV/PM EZOLV Sets the contrast of the LCD display on the keypad.	5 (0 - 10)	978
o1-10 (0520)	User Units Maximum Value	V/f CL-V/f OLV CLV AOLV OLV/PM AOLV/PM CLV/PM EZOLV Sets the value that the drive shows as the maximum output frequency.	Determined by o1-03 (1 - 6000)	978
o1-11 (0521)	User Units Decimal Position	V/f CL-V/f OLV CLV AOLV OLV/PM AOLV/PM CLV/PM EZOLV Sets the number of decimal places for frequency reference and monitor values. 0 : No Decimal Places (XXXXX) 1 : One Decimal Places (XXXX.X) 2 : Two Decimal Places (XXX.XX) 3 : Three Decimal Places (XX.XXX)	Determined by o1-03 (0 - 3)	978
o1-24 to o1-35: (11AD - 11B8) RUN	Custom Monitor 1 to 12	V/f CL-V/f OLV CLV AOLV OLV/PM AOLV/PM CLV/PM EZOLV Sets a maximum of 12 monitors as user monitors. This parameter is only available when using an LCD keypad.	o1-24: 101 o1-25: 102 o1-26: 103 o1-27 to o1-35: 0 (0, 101 - 999)	978
o1-36 (11B9) RUN	LCD Backlight Brightness	V/f CL-V/f OLV CLV AOLV OLV/PM AOLV/PM CLV/PM EZOLV Sets the intensity of the LCD keypad backlight.	5 (1 - 5)	979
o1-37 (11BA) RUN	LCD Backlight ON/OFF Selection	V/f CL-V/f OLV CLV AOLV OLV/PM AOLV/PM CLV/PM EZOLV Sets the automatic shut off function for the LCD backlight. 0 : OFF 1 : ON	0 (0, 1)	979
o1-38 (11BB) RUN	LCD Backlight Off-Delay	V/f CL-V/f OLV CLV AOLV OLV/PM AOLV/PM CLV/PM EZOLV Sets the time until the LCD backlight automatically turns off.	60 s (10 - 300 s)	979
o1-39 (11BC) RUN	Show Initial Setup Screen	V/f CL-V/f OLV CLV AOLV OLV/PM AOLV/PM CLV/PM EZOLV Sets the function to show the LCD keypad initial setup screen each time the drive is energized. This parameter is only available when using an LCD keypad. 0 : No 1 : Yes	1 (0, 1)	980

11.13 o: Keypad-Related Settings

No. (Hex.)	Name	Description	Default (Range)	Ref.
o1-40 (11BD) RUN	Home Screen Display Selection	<p>V/f CL-V/f OLV CLV AOLV OLV/PM AOLV/PM CLV/PM EZOLV</p> <p>Sets the monitor display mode for the Home screen. This parameter is only available when using an LCD keypad.</p> <p>0 : Custom Monitor 1 : Bar Graph 2 : Analog Gauge 3 : Trend Plot</p>	0 (0 - 3)	980
o1-41 (11C1) RUN	1st Monitor Area Selection	<p>V/f CL-V/f OLV CLV AOLV OLV/PM AOLV/PM CLV/PM EZOLV</p> <p>Sets the horizontal range used to display the monitor set in o1-24 [<i>Custom Monitor 1</i>] as a bar graph. This parameter is only available when using an LCD keypad.</p> <p>0 : +/- Area (- o1-42 ~ o1-42) 1 : + Area (0 ~ o1-42) 2 : - Area (- o1-42 ~ 0)</p>	0 (0 - 2)	980
o1-42 (11C2) RUN	1st Monitor Area Setting	<p>V/f CL-V/f OLV CLV AOLV OLV/PM AOLV/PM CLV/PM EZOLV</p> <p>Sets the horizontal axis value used to display the monitor set in o1-24 [<i>Custom Monitor 1</i>] as a bar graph. This parameter is only available when using an LCD keypad.</p>	100.0% (0.0 - 100.0%)	980
o1-43 (11C3) RUN	2nd Monitor Area Selection	<p>V/f CL-V/f OLV CLV AOLV OLV/PM AOLV/PM CLV/PM EZOLV</p> <p>Selects the horizontal range used to display the monitor set in o1-25 [<i>Custom Monitor 2</i>] as a bar graph. This parameter is only available when using an LCD keypad.</p> <p>0 : +/- Area (- o1-44 ~ o1-44) 1 : + Area (0 ~ o1-44) 2 : - Area (- o1-44 ~ 0)</p>	0 (0 - 2)	980
o1-44 (11C4) RUN	2nd Monitor Area Setting	<p>V/f CL-V/f OLV CLV AOLV OLV/PM AOLV/PM CLV/PM EZOLV</p> <p>Sets the horizontal axis value used to display the monitor set in o1-25 [<i>Custom Monitor 2</i>] as a bar graph. This parameter is only available when using an LCD keypad.</p>	100.0% (0.0 - 100.0%)	981
o1-45 (11C5) RUN	3rd Monitor Area Selection	<p>V/f CL-V/f OLV CLV AOLV OLV/PM AOLV/PM CLV/PM EZOLV</p> <p>Sets the horizontal range used to display the monitor set in o1-26 [<i>Custom Monitor 3</i>] as a bar graph. This parameter is only available when using an LCD keypad.</p> <p>0 : +/- Area (- o1-46 ~ o1-46) 1 : + Area (0 ~ o1-46) 2 : - Area (- o1-46 ~ 0)</p>	0 (0 - 2)	981
o1-46 (11C6) RUN	3rd Monitor Area Setting	<p>V/f CL-V/f OLV CLV AOLV OLV/PM AOLV/PM CLV/PM EZOLV</p> <p>Sets the horizontal axis value used to display the monitor set in o1-26 [<i>Custom Monitor 3</i>] as a bar graph. This parameter is only available when using an LCD keypad.</p>	100.0% (0.0 - 100.0%)	981
o1-47 (11C7) RUN	Trend Plot 1 Scale Minimum Value	<p>V/f CL-V/f OLV CLV AOLV OLV/PM AOLV/PM CLV/PM EZOLV</p> <p>Sets the horizontal axis minimum value used to display the monitor set in o1-24 [<i>Custom Monitor 1</i>] as a trend plot. This parameter is only available when using an LCD keypad.</p>	-100.0% (-300.0 - +300.0%)	981
o1-48 (11C8) RUN	Trend Plot 1 Scale Maximum Value	<p>V/f CL-V/f OLV CLV AOLV OLV/PM AOLV/PM CLV/PM EZOLV</p> <p>Sets the horizontal axis maximum value used to display the monitor set in o1-24 [<i>Custom Monitor 1</i>] as a trend plot. This parameter is only available when using an LCD keypad.</p>	100.0% (-300.0 - +300.0%)	981
o1-49 (11C9) RUN	Trend Plot 2 Scale Minimum Value	<p>V/f CL-V/f OLV CLV AOLV OLV/PM AOLV/PM CLV/PM EZOLV</p> <p>Sets the horizontal axis minimum value used to display the monitor set in o1-25 [<i>Custom Monitor 2</i>] as a trend plot. This parameter is only available when using an LCD keypad.</p>	-100.0% (-300.0 - +300.0%)	981
o1-50 (11CA) RUN	Trend Plot 2 Scale Maximum Value	<p>V/f CL-V/f OLV CLV AOLV OLV/PM AOLV/PM CLV/PM EZOLV</p> <p>Sets the horizontal axis maximum value used to display the monitor set in o1-25 [<i>Custom Monitor 2</i>] as a trend plot. This parameter is only available when using an LCD keypad.</p>	100.0% (-300.0 - +300.0%)	981
o1-51 (11CB) RUN	Trend Plot Time Scale Setting	<p>V/f CL-V/f OLV CLV AOLV OLV/PM AOLV/PM CLV/PM EZOLV</p> <p>Sets the time scale (horizontal axis) to display the trend plot. When you change this setting, the drive automatically adjusts the data sampling time. This parameter is only available when using an LCD keypad.</p>	300 s (1 - 3600 s)	982
o1-55 (11EE) RUN	Analog Gauge Area Selection	<p>V/f CL-V/f OLV CLV AOLV OLV/PM AOLV/PM CLV/PM EZOLV</p> <p>Sets the range used to display the monitor set in o1-24 [<i>Custom Monitor 1</i>] as an analog gauge. This parameter is only available when using an LCD keypad.</p> <p>0 : +/- Area (- o1-56 ~ o1-56) 1 : + Area (0 ~ o1-56)</p>	1 (0, 1)	982

No. (Hex.)	Name	Description	Default (Range)	Ref.
o1-56 (11EF) RUN	Analog Gauge Area Setting	V/f CL-V/f OLV CLV AOLV OLV/PM AOLV/PM CLV/PM EZOLV Sets the value used to display the monitor set in o1-24 [Custom Monitor 1] as an analog meter. This parameter is only available when using an LCD keypad.	100.0% (0.0 - 100.0%)	982
o1-58 (3125)	Motor Power Unit Selection	V/f CL-V/f OLV CLV AOLV OLV/PM AOLV/PM CLV/PM EZOLV Sets the setting unit for parameters that set the motor rated power. 0 : kW 1 : HP	1 (0, 1)	982

◆ o2: Keypad Operation

No. (Hex.)	Name	Description	Default (Range)	Ref.
o2-01 (0505)	LO/RE Key Function Selection	V/f CL-V/f OLV CLV AOLV OLV/PM AOLV/PM CLV/PM EZOLV Sets the function that lets you use LO/RE to switch between LOCAL and REMOTE Modes. 0 : Disabled 1 : Enabled	1 (0, 1)	982
o2-02 (0506)	STOP Key Function Selection	V/f CL-V/f OLV CLV AOLV OLV/PM AOLV/PM CLV/PM EZOLV Sets the function to use  on the keypad to stop the drive when the Run command source for the drive is REMOTE (external) and not assigned to the keypad. 0 : Disabled 1 : Enabled	1 (0, 1)	983
o2-03 (0507)	User Parameter Default Value	V/f CL-V/f OLV CLV AOLV OLV/PM AOLV/PM CLV/PM EZOLV Sets the function to keep the settings of changed parameters as user parameter defaults to use during initialization. 0 : No change 1 : Set defaults 2 : Clear all	0 (0 - 2)	983
o2-04 (0508)	Drive Model (KVA) Selection	V/f CL-V/f OLV CLV AOLV OLV/PM AOLV/PM CLV/PM EZOLV Sets the Drive Model code. Set this parameter after replacing the control board.	Determined by the drive (-)	984
o2-05 (0509)	Home Mode Freq Ref Entry Mode	V/f CL-V/f OLV CLV AOLV OLV/PM AOLV/PM CLV/PM EZOLV Sets the function that makes it necessary to push  to use the keypad to change the frequency reference value while in Drive Mode. 0 : ENTER Key Required 1 : Immediate / MOP-style	0 (0, 1)	985
o2-06 (050A)	Keypad Disconnect Detection	V/f CL-V/f OLV CLV AOLV OLV/PM AOLV/PM CLV/PM EZOLV Sets the function that stops the drive if you disconnect the keypad connection cable from the drive or if you damage the cable while the keypad is the Run command source. 0 : Disabled 1 : Enabled	1 (0, 1)	985
o2-07 (0527)	Keypad RUN Direction @ Power-up	V/f CL-V/f OLV CLV AOLV OLV/PM AOLV/PM CLV/PM EZOLV Sets the direction of motor rotation when the drive is energized and the keypad is the Run command source. 0 : Forward 1 : Reverse	0 (0, 1)	985
o2-09 (050D)	Reserved	-	-	985
o2-23 (11F8) RUN	External 24V Powerloss Detection	V/f CL-V/f OLV CLV AOLV OLV/PM AOLV/PM CLV/PM EZOLV Sets the function to give a warning when the backup external 24 V power supply turns off when the main circuit power supply is in operation. 0 : Disabled 1 : Enabled	0 (0, 1)	986
o2-24 (11FE)	LED Light Function Selection	V/f CL-V/f OLV CLV AOLV OLV/PM AOLV/PM CLV/PM EZOLV Sets the function to show the LED status rings and keypad LED lamps. Note: When you use A1-03 [Initialize Parameters] to initialize the drive, the drive will not reset this parameter. 0 : Enable Status Ring & Keypad LED 1 : LED Status Ring Disable 2 : Keypad LED Light Disable	2 (0 - 2)	986

11.13 o: Keypad-Related Settings

No. (Hex.)	Name	Description	Default (Range)	Ref.
o2-26 (1563)	Alarm display at ext. 24V power	<p>V/f CL-V/f OLV CLV AOLV OLV/PM AOLV/PM CLV/PM EZOLV</p> <p>When you connect a backup external 24 V power supply, this parameter sets the function to trigger an alarm when the main circuit power supply voltage decreases.</p> <p>Note: The drive will not run when it is operating from one 24-V external power supply.</p> <p>0 : No 1 : Yes</p>	1 (0, 1)	986
o2-27 (1565)	bCE Detection Selection	<p>V/f CL-V/f OLV CLV AOLV OLV/PM AOLV/PM CLV/PM EZOLV</p> <p>Sets drive operation if the Bluetooth device is disconnected when you operate the drive in Bluetooth Mode.</p> <p>0 : Ramp to Stop 1 : Coast to Stop 2 : Fast Stop (Use <i>Cl-09</i>) 3 : Alarm Only 4 : No Alarm Display</p>	3 (0 - 4)	986

◆ o3: Copy Keypad Function

No. (Hex.)	Name	Description	Default (Range)	Ref.
o3-01 (0515)	Copy Keypad Function Selection	<p>V/f CL-V/f OLV CLV AOLV OLV/PM AOLV/PM CLV/PM EZOLV</p> <p>Sets the function that saves and copies drive parameters to a different drive with the keypad.</p> <p>0 : Copy Select 1 : Backup (drive → keypad) 2 : Restore (keypad → drive) 3 : Verify (check for mismatch) 4 : Erase (backup data of keypad)</p>	0 (0 - 4)	987
o3-02 (0516)	Copy Allowed Selection	<p>V/f CL-V/f OLV CLV AOLV OLV/PM AOLV/PM CLV/PM EZOLV</p> <p>Sets the copy function when <i>o3-01 = 1</i> [<i>Copy Keypad Function Selection = Backup (drive → keypad)</i>].</p> <p>0 : Disabled 1 : Enabled</p>	0 (0, 1)	987
o3-04 (0B3E)	Select Backup/Restore Location	<p>V/f CL-V/f OLV CLV AOLV OLV/PM AOLV/PM CLV/PM EZOLV</p> <p>Sets the storage location for drive parameters when you back up and restore parameters. This parameter is only available when using an LCD keypad.</p> <p>0 : Memory Location 1 1 : Memory Location 2 2 : Memory Location 3 3 : Memory Location 4</p>	0 (0 - 3)	987
o3-05 (0BDA)	Select Items to Backup/Restore	<p>V/f CL-V/f OLV CLV AOLV OLV/PM AOLV/PM CLV/PM EZOLV</p> <p>Sets which parameters are backed up, restored, and referenced. This parameter is only available when using an LCD keypad.</p> <p>0 : Standard Parameters 1 : Standard + DWEZ Parameters</p>	1 (0, 1)	987
o3-06 (0BDE)	Auto Parameter Backup Selection	<p>V/f CL-V/f OLV CLV AOLV OLV/PM AOLV/PM CLV/PM EZOLV</p> <p>Sets the function that automatically backs up parameters. This parameter is only available when using an LCD keypad.</p> <p>0 : Disabled 1 : Enabled</p>	1 (0, 1)	988
o3-07 (0BDF)	Auto Parameter Backup Interval	<p>V/f CL-V/f OLV CLV AOLV OLV/PM AOLV/PM CLV/PM EZOLV</p> <p>Sets the interval at which the automatic parameter backup function saves parameters from the drive to the keypad.</p> <p>Note: This parameter is only available when using an LCD keypad.</p> <p>0 : Every 10 minutes 1 : Every 30 minutes 2 : Every 60 minutes 3 : Every 12 hours</p>	1 (0 - 3)	988

◆ o4: Maintenance Monitors

No. (Hex.)	Name	Description	Default (Range)	Ref.
o4-01 (050B)	Elapsed Operating Time Setting	V/f CL-V/f OLV CLV AOLV OLV/PM AOLV/PM CLV/PM EZOLV Sets the initial value of the cumulative drive operation time in 10-hour units.	0 h (0 - 9999 h)	988
o4-02 (050C)	Elapsed Operating Time Selection	V/f CL-V/f OLV CLV AOLV OLV/PM AOLV/PM CLV/PM EZOLV Sets the condition that counts the cumulative operation time. 0 : U4-01 Shows Total Power-up Time 1 : U4-01 Shows Total RUN Time	0 (0, 1)	989
o4-03 (050E)	Fan Operation Time Setting	V/f CL-V/f OLV CLV AOLV OLV/PM AOLV/PM CLV/PM EZOLV Sets the value from which to start the cumulative drive cooling fan operation time in 10-hour units.	0 h (0 - 9999 h)	989
o4-05 (051D)	Capacitor Maintenance Setting	V/f CL-V/f OLV CLV AOLV OLV/PM AOLV/PM CLV/PM EZOLV Sets the U4-05 [<i>CapacitorMaintenance</i>] monitor value.	0% (0 - 150%)	989
o4-07 (0523)	Softcharge Relay Maintenance Set	V/f CL-V/f OLV CLV AOLV OLV/PM AOLV/PM CLV/PM EZOLV Sets the U4-06 [<i>PreChargeRelayMainte</i>] monitor value.	0% (0 - 150%)	989
o4-09 (0525)	IGBT Maintenance Setting	V/f CL-V/f OLV CLV AOLV OLV/PM AOLV/PM CLV/PM EZOLV Sets the U4-07 [<i>IGBT Maintenance</i>] monitor value.	0% (0 - 150%)	989
o4-11 (0510)	Fault Trace/History Init (U2/U3)	V/f CL-V/f OLV CLV AOLV OLV/PM AOLV/PM CLV/PM EZOLV Resets the records of Monitors U2-xx [<i>Fault Trace</i>] and U3-xx [<i>Fault History</i>]. 0 : Disabled 1 : Enabled	0 (0, 1)	990
o4-12 (0512)	kWh Monitor Initialization	V/f CL-V/f OLV CLV AOLV OLV/PM AOLV/PM CLV/PM EZOLV Resets the monitor values for U4-10 [<i>kWh, Lower 4 Digits</i>] and U4-11 [<i>kWh, Upper 5 Digits</i>]. 0 : No Reset 1 : Reset	0 (0, 1)	990
o4-13 (0528)	RUN Command Counter @ Initialize	V/f CL-V/f OLV CLV AOLV OLV/PM AOLV/PM CLV/PM EZOLV Resets the monitor values for U4-02 [<i>Num of Run Commands</i>], U4-24 [<i>Number of Runs (Low)</i>], and U4-25 [<i>Number of Runs (High)</i>]. 0 : No Reset 1 : Reset	0 (0, 1)	990
o4-22 (154F) RUN	Time Format	V/f CL-V/f OLV CLV AOLV OLV/PM AOLV/PM CLV/PM EZOLV Sets the time display format. This parameter is only available when using an LCD keypad. 0 : 24 Hour Clock 1 : 12 Hour Clock 2 : 12 Hour JP Clock	1 (0 - 2)	990
o4-23 (1550) RUN	Date Format	V/f CL-V/f OLV CLV AOLV OLV/PM AOLV/PM CLV/PM EZOLV Sets the date display format. This parameter is only available when using an LCD keypad. 0 : YYYY/MM/DD 1 : DD/MM/YYYY 2 : MM/DD/YYYY	2 (0 - 2)	991
o4-24 (310F) RUN	bAT Detection Selection	V/f CL-V/f OLV CLV AOLV OLV/PM AOLV/PM CLV/PM EZOLV Sets operation when the drive detects bAT [<i>Keypad Battery Low Voltage</i>] and TiM [<i>Keypad Time Not Set</i>]. 0 : Disable 1 : Enable (Alarm Detected) 2 : Enable (Fault Detected)	0 (0 - 2)	991

◆ o5: Log Function

No. (Hex.)	Name	Description	Default (Range)	Ref.
o5-01 (1551) RUN	Log Start/Stop Selection	V/f CL-V/f OLV CLV AOLV OLV/PM AOLV/PM CLV/PM EZOLV Sets the data log function. This parameter is only available when using an LCD keypad. 0 : OFF 1 : ON	0 (0 - 1)	994
o5-02 (1552) RUN	Log Sampling Interval	V/f CL-V/f OLV CLV AOLV OLV/PM AOLV/PM CLV/PM EZOLV Sets the data log sampling cycle. This parameter is only available when using an LCD keypad.	100 ms (100 - 60000 ms)	994

11.13 o: Keypad-Related Settings

No. (Hex.)	Name	Description	Default (Range)	Ref.
o5-03 (1553) RUN	Log Monitor Data 1	V/f CL-V/f OLV CLV AOLV OLV/PM AOLV/PM CLV/PM EZOLV Sets the data log monitor. This parameter is only available when using an LCD keypad.	101 (000, 101 - 999)	994
o5-04 (1554) RUN	Log Monitor Data 2	V/f CL-V/f OLV CLV AOLV OLV/PM AOLV/PM CLV/PM EZOLV Sets the data log monitor. This parameter is only available when using an LCD keypad.	102 (000, 101 - 999)	994
o5-05 (1555) RUN	Log Monitor Data 3	V/f CL-V/f OLV CLV AOLV OLV/PM AOLV/PM CLV/PM EZOLV Sets the data log monitor. This parameter is only available when using an LCD keypad.	103 (000, 101 - 999)	995
o5-06 (1556) RUN	Log Monitor Data 4	V/f CL-V/f OLV CLV AOLV OLV/PM AOLV/PM CLV/PM EZOLV Sets the data log monitor. This parameter is only available when using an LCD keypad.	107 (000, 101 - 999)	995
o5-07 (1557) RUN	Log Monitor Data 5	V/f CL-V/f OLV CLV AOLV OLV/PM AOLV/PM CLV/PM EZOLV Sets the data log monitor. This parameter is only available when using an LCD keypad.	108 (000, 101 - 999)	995
o5-08 (1558) RUN	Log Monitor Data 6	V/f CL-V/f OLV CLV AOLV OLV/PM AOLV/PM CLV/PM EZOLV Sets the data log monitor. This parameter is only available when using an LCD keypad. Note: When $A1-02 = 0$ or 5 [Control Method Selection = <i>V/f</i> , <i>OLV/PM</i>], the default setting is 0 .	105 (000, 101 - 999)	995
o5-09 (1559) RUN	Log Monitor Data 7	V/f CL-V/f OLV CLV AOLV OLV/PM AOLV/PM CLV/PM EZOLV Sets the data log monitor. This parameter is only available when using an LCD keypad.	110 (000, 101 - 999)	995
o5-10 (155A) RUN	Log Monitor Data 8	V/f CL-V/f OLV CLV AOLV OLV/PM AOLV/PM CLV/PM EZOLV Sets the data log monitor. This parameter is only available when using an LCD keypad.	112 (000, 101 - 999)	996
o5-11 (155B) RUN	Log Monitor Data 9	V/f CL-V/f OLV CLV AOLV OLV/PM AOLV/PM CLV/PM EZOLV Sets the data log monitor. This parameter is only available when using an LCD keypad.	000 (000, 101 - 999)	996
o5-12 (155C) RUN	Log Monitor Data 10	V/f CL-V/f OLV CLV AOLV OLV/PM AOLV/PM CLV/PM EZOLV Sets the data log monitor. This parameter is only available when using an LCD keypad.	000 (000, 101 - 999)	996

11.14 q: DriveWorksEZ Parameters

◆ q1-01 to q8-40: Reserved for DriveWorksEZ

No. (Hex.)	Name	Description	Default (Range)
q1-01 to q8-40 (1600 - 17E7)	Reserved for DriveWorksEZ	V/f CL-V/f OLV CLV AOLV OLV/PM AOLV/PM CLV/PM EZOLV Refer to "DriveWorksEZ Operation Manual".	These parameters are reserved for use with DriveWorksEZ.

11.15 r: DWEZ Connection 1-20

◆ r1-01 to r1-40: DriveWorksEZ Connection Parameters 1 to 20 (Upper / Lower)

No. (Hex.)	Name	Description	Default (Range)
r1-01 to r1-40: (1840 - 1867)	DriveWorksEZ Connection Parameters 1 to 20 (Upper / Lower)	V/f CL-V/f OLV CLV AOLV OLV/PM AOLV/PM CLV/PM EZOLV DriveWorksEZ Connection Parameters 1 to 20 (Upper / Lower)	0 (0 - FFFFH)

11.16 T: Motor Tuning

◆ T0: Tuning Mode Selection

No. (Hex.)	Name	Description	Default (Range)	Ref.
T0-00 (1197)	Tuning Mode Selection	<p>V/f CL-V/f OLV CLV AOLV OLV/PM AOLV/PM CLV/PM EZOLV</p> <p>Sets the type of Auto-Tuning. 0 : Motor Parameter Tuning 1 : Control Tuning</p>	0 (0, 1)	997

◆ T1: Induction Motor Auto-Tuning

No. (Hex.)	Name	Description	Default (Range)	Ref.
T1-00 (0700)	Motor 1/Motor 2 Selection	<p>V/f CL-V/f OLV CLV AOLV OLV/PM AOLV/PM CLV/PM EZOLV</p> <p>Sets which motor to tune when motor 1/2 switching is enabled. You can only use the keypad to set this parameter. You cannot use external input terminals to set it. Note: This parameter is available when $H1-xx = 16$ [Motor 2 Selection]. The keypad will not show this parameter when $H1-xx \neq 16$. 1 : Motor 1 (sets E1-xx, E2-xx) 2 : Motor 2 (sets E3-xx, E4-xx)</p>	1 (1, 2)	997
T1-01 (0701)	Tuning Mode Selection	<p>V/f CL-V/f OLV CLV AOLV OLV/PM AOLV/PM CLV/PM EZOLV</p> <p>Sets the type of Auto-Tuning. 0 : Rotational Auto-Tuning 1 : Stationary Auto-Tuning 1 2 : Stationary Line-Line Resistance</p>	Determined by A1-02 (Determined by A1-02)	998
T1-02 (0702)	Motor Rated Power	<p>V/f CL-V/f OLV CLV AOLV OLV/PM AOLV/PM CLV/PM EZOLV</p> <p>Uses the units set in $o1-58$ [Motor Power Unit Selection] to set the motor rated output power.</p>	Determined by $o2-04$, C6-01 (0.00 - 650.00 HP)	998
T1-03 (0703)	Motor Rated Voltage	<p>V/f CL-V/f OLV CLV AOLV OLV/PM AOLV/PM CLV/PM EZOLV</p> <p>Sets the rated voltage (V) of the motor. Enter the base speed voltage for constant output motors.</p>	Determined by $o2-04$, C6-01 (200 V Class: 0.0 - 255.5 V, 400 V Class: 0.0 - 511.0 V)	998
T1-04 (0704)	Motor Rated Current	<p>V/f CL-V/f OLV CLV AOLV OLV/PM AOLV/PM CLV/PM EZOLV</p> <p>Sets the rated current (A) of the motor.</p>	Determined by $o2-04$ (10% to 200% of the drive rated current)	998
T1-05 (0705)	Motor Base Frequency	<p>V/f CL-V/f OLV CLV AOLV OLV/PM AOLV/PM CLV/PM EZOLV</p> <p>Sets the base frequency (Hz) of the motor.</p>	60.0 Hz (0.0 - 590.0 Hz)	998
T1-06 (0706)	Number of Motor Poles	<p>V/f CL-V/f OLV CLV AOLV OLV/PM AOLV/PM CLV/PM EZOLV</p> <p>Sets the number of motor poles.</p>	4 (2 to 120)	999
T1-07 (0707)	Motor Base Speed	<p>V/f CL-V/f OLV CLV AOLV OLV/PM AOLV/PM CLV/PM EZOLV</p> <p>Sets the motor base speed for Auto-Tuning (min^{-1} (r/min)).</p>	1750 min^{-1} (r/min) (0 - 35400 min^{-1} (r/min))	999
T1-08 (0708)	Encoder Pulse Count (PPR)	<p>V/f CL-V/f OLV CLV AOLV OLV/PM AOLV/PM CLV/PM EZOLV</p> <p>Sets the number of PG (pulse generator, encoder) pulses.</p>	1024 ppr (0 - 60,000 ppr)	999
T1-09 (0709)	Motor No-Load Current	<p>V/f CL-V/f OLV CLV AOLV OLV/PM AOLV/PM CLV/PM EZOLV</p> <p>Sets the no-load current of the motor.</p>	- (0A - T1-04; max. of 2999.9)	999
T1-10 (070A)	Motor Rated Slip Frequency	<p>V/f CL-V/f OLV CLV AOLV OLV/PM AOLV/PM CLV/PM EZOLV</p> <p>Sets motor rated slip.</p>	- (0.000 - 20.000 Hz)	999
T1-11 (070B)	Motor Iron Loss	<p>V/f CL-V/f OLV CLV AOLV OLV/PM AOLV/PM CLV/PM EZOLV</p> <p>Sets the iron loss for calculating the energy-saving coefficient.</p>	Determined by E2-11 or E4-11 (0 - 65535 W)	999

11.16 T: Motor Tuning

No. (Hex.)	Name	Description	Default (Range)	Ref.
T1-12 (0BDB)	Test Mode Selection	<p><input type="checkbox"/> V/f <input type="checkbox"/> CL-V/f <input checked="" type="checkbox"/> OLV <input checked="" type="checkbox"/> CLV <input checked="" type="checkbox"/> AOLV <input type="checkbox"/> OLV/PM <input type="checkbox"/> AOLV/PM <input type="checkbox"/> CLV/PM <input type="checkbox"/> EZOLV</p> <p>Sets the function to enable Test Mode after Stationary Auto-Tuning. When you can operate the motor with a light load attached after Stationary Auto-Tuning is complete, enable this parameter.</p> <p>Note: You must first set $T1-10 = 0$ [Motor Rated Slip Frequency = 0 Hz] to enable this parameter.</p> <p>0 : No 1 : Yes</p>	0 (0, 1)	1000
T1-13 (0BDC)	No-load voltage	<p><input type="checkbox"/> V/f <input type="checkbox"/> CL-V/f <input checked="" type="checkbox"/> OLV <input checked="" type="checkbox"/> CLV <input checked="" type="checkbox"/> AOLV <input type="checkbox"/> OLV/PM <input type="checkbox"/> AOLV/PM <input type="checkbox"/> CLV/PM <input type="checkbox"/> EZOLV</p> <p>Sets the no-load voltage of the motor. If you know the no-load voltage at the rated speed in a test report, set that voltage value. If you do not know the no-load voltage, do not change from the initial value.</p> <p>Note:</p> <ul style="list-style-type: none"> To get the same qualities as a Yaskawa 1000-series drive or previous models, set this parameter = $T1-03$ [Motor Rated Voltage] value. The default value is different for different models. <ul style="list-style-type: none"> -2004 - 2008, 4002 - 4004: $T1-03 \times 0.85$ -2010 - 2415, 4005 - 4302: $T1-03 \times 0.90$ -4371 - 4720: $T1-03 \times 0.95$ 	$T1-03 \times 0.85$ (200 V Class: 0.0 - 255.0 V, 400 V Class: 0.0 - 510.0 V)	1000

◆ T2: PM Motor Auto-Tuning

No. (Hex.)	Name	Description	Default (Range)	Ref.
T2-01 (0750)	PM Auto-Tuning Selection	<p><input type="checkbox"/> V/f <input type="checkbox"/> CL-V/f <input type="checkbox"/> OLV <input type="checkbox"/> CLV <input type="checkbox"/> AOLV <input checked="" type="checkbox"/> OLV/PM <input checked="" type="checkbox"/> AOLV/PM <input checked="" type="checkbox"/> CLV/PM <input type="checkbox"/> EZOLV</p> <p>Sets the type of Auto-Tuning for PM motors.</p> <p>0 : Manual Entry w/ Motor Data Sheet 1 : Stationary (Ld, Lq, R) 2 : Stationary (R Only) 3 : Z-Pulse Offset (Pole Position) 4 : Rotational (Ld, Lq, R, back-EMF) 5 : High Frequency Injection</p>	0 (Determined by A1-02)	1000
T2-02 (0751)	PM Motor Code Selection	<p><input type="checkbox"/> V/f <input type="checkbox"/> CL-V/f <input type="checkbox"/> OLV <input type="checkbox"/> CLV <input type="checkbox"/> AOLV <input checked="" type="checkbox"/> OLV/PM <input checked="" type="checkbox"/> AOLV/PM <input checked="" type="checkbox"/> CLV/PM <input type="checkbox"/> EZOLV</p> <p>If the drive is operating a Yaskawa PM motor from the SMRA, SSR1, or SST4 series, enter the PM motor code in accordance with the rotation speed and motor output.</p>	FFFF (0000 - FFFF)	1001
T2-03 (0752)	PM Motor Type	<p><input type="checkbox"/> V/f <input type="checkbox"/> CL-V/f <input type="checkbox"/> OLV <input type="checkbox"/> CLV <input type="checkbox"/> AOLV <input checked="" type="checkbox"/> OLV/PM <input checked="" type="checkbox"/> AOLV/PM <input checked="" type="checkbox"/> CLV/PM <input type="checkbox"/> EZOLV</p> <p>Sets the type of PM motor the drive will operate.</p> <p>0 : IPM motor 1 : SPM motor</p>	1 (0, 1)	1001
T2-04 (0730)	PM Motor Rated Power	<p><input type="checkbox"/> V/f <input type="checkbox"/> CL-V/f <input type="checkbox"/> OLV <input type="checkbox"/> CLV <input type="checkbox"/> AOLV <input checked="" type="checkbox"/> OLV/PM <input checked="" type="checkbox"/> AOLV/PM <input checked="" type="checkbox"/> CLV/PM <input type="checkbox"/> EZOLV</p> <p>Uses the units set in $o1-58$ [Motor Power Unit Selection] to set the PM motor rated output power.</p>	Determined by o2-04, C6-01 (0.00 - 650.00 HP)	1001
T2-05 (0732)	PM Motor Rated Voltage	<p><input type="checkbox"/> V/f <input type="checkbox"/> CL-V/f <input type="checkbox"/> OLV <input type="checkbox"/> CLV <input type="checkbox"/> AOLV <input checked="" type="checkbox"/> OLV/PM <input checked="" type="checkbox"/> AOLV/PM <input checked="" type="checkbox"/> CLV/PM <input type="checkbox"/> EZOLV</p> <p>Sets the rated voltage (V) of the motor.</p>	200 V Class: 230.0 V, 400 V: 460.0 V (200 V Class: 0.0 - 255.0 V, 400 V Class: 0.0 - 510.0 V)	1001
T2-06 (0733)	PM Motor Rated Current	<p><input type="checkbox"/> V/f <input type="checkbox"/> CL-V/f <input type="checkbox"/> OLV <input type="checkbox"/> CLV <input type="checkbox"/> AOLV <input checked="" type="checkbox"/> OLV/PM <input checked="" type="checkbox"/> AOLV/PM <input checked="" type="checkbox"/> CLV/PM <input type="checkbox"/> EZOLV</p> <p>Sets the rated current (A) of the motor.</p>	Determined by o2-04 (10% to 200% of the drive rated current)	1001
T2-07 (0753)	PM Motor Base Frequency	<p><input type="checkbox"/> V/f <input type="checkbox"/> CL-V/f <input type="checkbox"/> OLV <input type="checkbox"/> CLV <input type="checkbox"/> AOLV <input checked="" type="checkbox"/> OLV/PM <input checked="" type="checkbox"/> AOLV/PM <input checked="" type="checkbox"/> CLV/PM <input type="checkbox"/> EZOLV</p> <p>Sets the base frequency (Hz) of the motor.</p>	60.0 Hz (0.0 - 590.0 Hz)	1001
T2-08 (0734)	Number of PM Motor Poles	<p><input type="checkbox"/> V/f <input type="checkbox"/> CL-V/f <input type="checkbox"/> OLV <input type="checkbox"/> CLV <input type="checkbox"/> AOLV <input checked="" type="checkbox"/> OLV/PM <input checked="" type="checkbox"/> AOLV/PM <input checked="" type="checkbox"/> CLV/PM <input type="checkbox"/> EZOLV</p> <p>Sets the number of motor poles.</p>	4 (2 - 48)	1002
T2-09 (0731)	PM Motor Base Speed	<p><input type="checkbox"/> V/f <input type="checkbox"/> CL-V/f <input type="checkbox"/> OLV <input type="checkbox"/> CLV <input type="checkbox"/> AOLV <input type="checkbox"/> OLV/PM <input type="checkbox"/> AOLV/PM <input type="checkbox"/> CLV/PM <input type="checkbox"/> EZOLV</p> <p>Sets the motor base speed (min^{-1} (r/min)).</p>	1750 min^{-1} (r/min) (0 - 34500 min^{-1} (r/min))	1002
T2-10 (0754)	PM Motor Stator Resistance	<p><input type="checkbox"/> V/f <input type="checkbox"/> CL-V/f <input type="checkbox"/> OLV <input type="checkbox"/> CLV <input type="checkbox"/> AOLV <input checked="" type="checkbox"/> OLV/PM <input checked="" type="checkbox"/> AOLV/PM <input checked="" type="checkbox"/> CLV/PM <input type="checkbox"/> EZOLV</p> <p>Sets the stator resistance for each motor phase.</p> <p>Note: This parameter does not set line-to-line resistance.</p>	Determined by T2-02 (0.000 - 65.000 Ω)	1002
T2-11 (0735)	PM Motor d-Axis Inductance	<p><input type="checkbox"/> V/f <input type="checkbox"/> CL-V/f <input type="checkbox"/> OLV <input type="checkbox"/> CLV <input type="checkbox"/> AOLV <input checked="" type="checkbox"/> OLV/PM <input checked="" type="checkbox"/> AOLV/PM <input checked="" type="checkbox"/> CLV/PM <input type="checkbox"/> EZOLV</p> <p>Sets the d-axis inductance of the motor on a per phase basis.</p>	Determined by T2-02 (0.00 - 600.00 mH)	1002

No. (Hex.)	Name	Description	Default (Range)	Ref.
T2-12 (0736)	PM Motor q-Axis Inductance	<input type="checkbox"/> V/f <input type="checkbox"/> CL-V/f <input type="checkbox"/> OLV <input type="checkbox"/> CLV <input type="checkbox"/> AOLV <input checked="" type="checkbox"/> OLV/PM <input checked="" type="checkbox"/> AOLV/PM <input checked="" type="checkbox"/> CLV/PM <input type="checkbox"/> EZOLV Sets the q-Axis inductance of the motor on a per phase basis.	Determined by T2-02 (0.00 - 600.00 mH)	1002
T2-13 (0755)	Back-EMF Units Selection	<input type="checkbox"/> V/f <input type="checkbox"/> CL-V/f <input type="checkbox"/> OLV <input type="checkbox"/> CLV <input type="checkbox"/> AOLV <input checked="" type="checkbox"/> OLV/PM <input checked="" type="checkbox"/> AOLV/PM <input checked="" type="checkbox"/> CLV/PM <input type="checkbox"/> EZOLV Sets the units that the drive uses to set the induced voltage constant. 0 : mV/(rev/min) 1 : mV/(rad/sec)	0 (0, 1)	1002
T2-14 (0737)	Back-EMF Voltage Constant (Ke)	<input type="checkbox"/> V/f <input type="checkbox"/> CL-V/f <input type="checkbox"/> OLV <input type="checkbox"/> CLV <input type="checkbox"/> AOLV <input checked="" type="checkbox"/> OLV/PM <input checked="" type="checkbox"/> AOLV/PM <input checked="" type="checkbox"/> CLV/PM <input type="checkbox"/> EZOLV Sets the motor induced voltage constant (Ke).	Determined by T2-13 (0.0 - 2000.0)	1002
T2-15 (0756)	Pull-In Current Level	<input type="checkbox"/> V/f <input type="checkbox"/> CL-V/f <input type="checkbox"/> OLV <input type="checkbox"/> CLV <input type="checkbox"/> AOLV <input checked="" type="checkbox"/> OLV/PM <input checked="" type="checkbox"/> AOLV/PM <input checked="" type="checkbox"/> CLV/PM <input type="checkbox"/> EZOLV Sets the level of the pull-in current as a percentage of E5-03 [PM Motor Rated Current (FLA)]. Usually it is not necessary to change this setting.	30% (0 - 120%)	1003
T2-16 (0738)	Encoder Pulse Count (PPR)	<input type="checkbox"/> V/f <input type="checkbox"/> CL-V/f <input type="checkbox"/> OLV <input type="checkbox"/> CLV <input type="checkbox"/> AOLV <input checked="" type="checkbox"/> OLV/PM <input checked="" type="checkbox"/> AOLV/PM <input checked="" type="checkbox"/> CLV/PM <input type="checkbox"/> EZOLV Sets the number of PG (pulse generator, encoder) pulses.	1024 ppr (1 - 15000 ppr)	1003
T2-17 (0757)	Encoder Z-Pulse Offset	<input type="checkbox"/> V/f <input type="checkbox"/> CL-V/f <input type="checkbox"/> OLV <input type="checkbox"/> CLV <input type="checkbox"/> AOLV <input checked="" type="checkbox"/> OLV/PM <input checked="" type="checkbox"/> AOLV/PM <input checked="" type="checkbox"/> CLV/PM <input type="checkbox"/> EZOLV Sets the encoder Z-pulse offset ($\Delta\theta$) (pulse generator, encoder) that is listed on the motor nameplate.	0.0 ° (-180.0 - +180.0°)	1003

◆ T3: ASR and Inertia Tuning

No. (Hex.)	Name	Description	Default (Range)	Ref.
T3-00 (1198)	Control Loop Tuning Selection	<input type="checkbox"/> V/f <input type="checkbox"/> CL-V/f <input type="checkbox"/> OLV <input type="checkbox"/> CLV <input type="checkbox"/> AOLV <input checked="" type="checkbox"/> OLV/PM <input checked="" type="checkbox"/> AOLV/PM <input checked="" type="checkbox"/> CLV/PM <input type="checkbox"/> EZOLV Sets the type of Control Auto-Tuning. 0 : Inertia Tuning 1 : ASR (Speed Regulator) 2 : Deceleration Rate Tuning 3 : KEB Tuning Note: Settings 0 and 1 are available only when A1-02 = 3, 7 [Control Method Selection = CLV, CLV/PM].	0 (0 - 3)	1003
T3-01 (0760)	Test Signal Frequency	<input type="checkbox"/> V/f <input type="checkbox"/> CL-V/f <input type="checkbox"/> OLV <input checked="" type="checkbox"/> CLV <input type="checkbox"/> AOLV <input checked="" type="checkbox"/> OLV/PM <input checked="" type="checkbox"/> AOLV/PM <input checked="" type="checkbox"/> CLV/PM <input type="checkbox"/> EZOLV Sets the frequency of the test signal applied to the motor during Inertia Tuning. Usually it is not necessary to change this setting.	3.0 Hz (0.1 - 20.0 Hz)	1003
T3-02 (0761)	Test Signal Amplitude	<input type="checkbox"/> V/f <input type="checkbox"/> CL-V/f <input type="checkbox"/> OLV <input checked="" type="checkbox"/> CLV <input type="checkbox"/> AOLV <input checked="" type="checkbox"/> OLV/PM <input checked="" type="checkbox"/> AOLV/PM <input checked="" type="checkbox"/> CLV/PM <input type="checkbox"/> EZOLV Sets the amplitude of the test signal applied to the motor during Inertia Tuning. Usually it is not necessary to change this setting.	0.5 rad (0.1 - 10.0 rad)	1003
T3-03 (0762)	Motor Inertia	<input type="checkbox"/> V/f <input type="checkbox"/> CL-V/f <input type="checkbox"/> OLV <input checked="" type="checkbox"/> CLV <input type="checkbox"/> AOLV <input checked="" type="checkbox"/> OLV/PM <input checked="" type="checkbox"/> AOLV/PM <input checked="" type="checkbox"/> CLV/PM <input type="checkbox"/> EZOLV Sets the inertia of the motor. This value uses the test signal response to calculate the load inertia. Note: The display units for the default setting and setting range are different for different models: • 0.0001 kgm ² units (setting range: 0.0001 kgm ² to 6.0000 kgm ²): 2004 to 2021, 4002 to 4012 • 0.001 kgm ² units (setting range: 0.001 kgm ² to 60.000 kgm ²): 2030 to 2211, 4018 to 4103 • 0.01 kgm ² units (setting range: 0.01 kgm ² to 600.00 kgm ²): 2257 to 2415, 4140 to 4720	Determined by o2-04, C6-01, and E5-01 (0.0001 - 600.00 kgm ²)	1004
T3-04 (0763)	System Response Frequency	<input type="checkbox"/> V/f <input type="checkbox"/> CL-V/f <input type="checkbox"/> OLV <input checked="" type="checkbox"/> CLV <input type="checkbox"/> AOLV <input checked="" type="checkbox"/> OLV/PM <input checked="" type="checkbox"/> AOLV/PM <input checked="" type="checkbox"/> CLV/PM <input type="checkbox"/> EZOLV This parameter uses the load inertia value from the Inertia Tuning process to automatically calculate and set C5-01 [ASR Proportional Gain 1].	10.0 Hz (0.1 - 50.0 Hz)	1004

◆ T4: EZ Tuning

No. (Hex.)	Name	Description	Default (Range)	Ref.
T4-01 (3130)	EZ Tuning Mode Selection	<p>V/f CL-V/f OLV CLV AOLV OLV/PM AOLV/PM CLV/PM EZOLV</p> <p>Sets the type of Auto-Tuning for EZOLV control. 0 : Motor Parameter Setting 1 : Line-to-Line Resistance</p>	0 (0, 1)	1004
T4-02 (3131)	Motor Type Selection	<p>V/f CL-V/f OLV CLV AOLV OLV/PM AOLV/PM CLV/PM EZOLV</p> <p>Sets the type of motor. 0 : Induction (IM) 1 : Permanent Magnet (PM) 2 : Synchronous Reluctance (SynRM)</p>	0 (0, 1, 2)	1005
T4-04 (3133)	Motor Rated Revolutions	<p>V/f CL-V/f OLV CLV AOLV OLV/PM AOLV/PM CLV/PM EZOLV</p> <p>Sets rated rotation speed (min⁻¹) of the motor.</p>	- ((40 Hz to 120 Hz) × 60 × 2/E9-08)	1005
T4-05 (3134)	Motor Rated Frequency	<p>V/f CL-V/f OLV CLV AOLV OLV/PM AOLV/PM CLV/PM EZOLV</p> <p>Sets the rated frequency (Hz) of the motor.</p>	Determined by E9-01 and o2-04 (40.0 - 120.0 Hz)	1005
T4-06 (3135)	Motor Rated Voltage	<p>V/f CL-V/f OLV CLV AOLV OLV/PM AOLV/PM CLV/PM EZOLV</p> <p>Sets the rated voltage (V) of the motor.</p>	200 V Class: 230.0 V, 400 V: 460.0 V (200 V Class: 0.0 - 255.0 V, 400 V Class: 0.0 - 510.0 V)	1005
T4-07 (3136)	Motor Rated Current	<p>V/f CL-V/f OLV CLV AOLV OLV/PM AOLV/PM CLV/PM EZOLV</p> <p>Sets the rated current (A) of the motor.</p>	Determined by o2-04, C6-01 (10% to 200% of the drive rated current)	1005
T4-08 (3137)	Motor Rated Capacity	<p>V/f CL-V/f OLV CLV AOLV OLV/PM AOLV/PM CLV/PM EZOLV</p> <p>Sets the motor rated power in the units set in o1-58 [Motor Power Unit Selection].</p>	Determined by E9-10 (0.10 - 650.00 HP)	1005
T4-09 (3138)	Number of Poles	<p>V/f CL-V/f OLV CLV AOLV OLV/PM AOLV/PM CLV/PM EZOLV</p> <p>Sets the number of motor poles.</p>	Determined by E9-01 (2 - 48)	1005

11.17 U: Monitors

◆ U1: Operation Status Monitors

No. (Hex.)	Name	Description	MFAO Signal Level
U1-01 (0040)	Frequency reference	<p>V/f CL-V/f OLV CLV AOLV OLV/PM AOLV/PM CLV/PM EZOLV</p> <p>Shows the actual frequency reference value. Parameter <i>o1-03</i> [Keypad Display Unit Selection] sets the display units. Unit: 0.01 Hz</p>	10 V = Maximum frequency (-10 V to +10 V)
U1-02 (0041)	Output Frequency	<p>V/f CL-V/f OLV CLV AOLV OLV/PM AOLV/PM CLV/PM EZOLV</p> <p>Shows the actual output frequency. Parameter <i>o1-03</i> [Keypad Display Unit Selection] sets the display units. Unit: 0.01 Hz</p>	10 V = Maximum frequency (-10 V to +10 V)
U1-03 (0042)	Output Current	<p>V/f CL-V/f OLV CLV AOLV OLV/PM AOLV/PM CLV/PM EZOLV</p> <p>Shows the actual output current. The keypad shows the value of <i>U1-03</i> in amperes (A). When looking at the monitor through MEMOBUS/Modbus communications, the current is "8192 = drive rated current (A)." Calculate the current from the monitor value that is in at MEMOBUS/Modbus communications using "Numerals being displayed / 8192 × drive rated current (A)." Unit: Determined by the drive model. • 0.01 A: 2004 to 2042, 4002 to 4023 • 0.1 A: 2056 to 2415, 4031 to 4720</p>	10 V = Drive rated current
U1-04 (0043)	Control Method	<p>V/f CL-V/f OLV CLV AOLV OLV/PM AOLV/PM CLV/PM EZOLV</p> <p>Shows the drive control method. 0 : V/f Control 1 : V/f Control with Encoder 2 : Open Loop Vector 3 : Closed Loop Vector 4 : Advanced Open Loop Vector 5 : PM Open Loop Vector 6 : PM Advanced Open Loop Vector 7 : PM Closed Loop Vector 8 : EZ Vector Control</p>	No signal output available
U1-05 (0044)	Motor Speed	<p>V/f CL-V/f OLV CLV AOLV OLV/PM AOLV/PM CLV/PM EZOLV</p> <p>Shows the actual detected motor speed. Parameter <i>o1-03</i> [Keypad Display Unit Selection] sets the display units. Unit: 0.01 Hz</p>	10 V = Maximum frequency (-10 V to +10 V)
U1-06 (0045)	Output Voltage Ref	<p>V/f CL-V/f OLV CLV AOLV OLV/PM AOLV/PM CLV/PM EZOLV</p> <p>Shows the output voltage reference. Unit: 0.1 V</p>	200 V class: 10 V = 200 V _{rms} 400 V class: 10 V = 400 V _{rms}
U1-07 (0046)	DC Bus Voltage	<p>V/f CL-V/f OLV CLV AOLV OLV/PM AOLV/PM CLV/PM EZOLV</p> <p>Shows the DC bus voltage. Unit: 1 V</p>	200 V class: 10 V = 400 V 400 V class: 10 V = 800 V
U1-08 (0047)	Output Power	<p>V/f CL-V/f OLV CLV AOLV OLV/PM AOLV/PM CLV/PM EZOLV</p> <p>Shows the internally-calculated output power. Changing the setting of <i>A1-02</i> [Control Method Selection] also changes the signal level of the analog output. • A1-02 = 0, 1: Drive capacity (kW) • A1-02 = 2, 3, 4: Motor Rated Power [E2-11] (kW) • A1-02 = 5, 6, 7: PM Motor Rated Power [E5-02] (kW) • A1-02 = 8: Motor Rated Power [E9-07] (kW) Unit: The display units are different for different models: • 0.01 kW: 2004 to 2042, 4002 to 4023 • 0.1 kW: 2056 to 2415, 4031 to 4720</p>	10 V: Drive capacity (motor rated power) kW (-10 V to +10 V)
U1-09 (0048)	Torque Reference	<p>V/f CL-V/f OLV CLV AOLV OLV/PM AOLV/PM CLV/PM EZOLV</p> <p>Shows the internal torque reference value. Unit: 0.1%</p>	10 V = Motor rated torque (-10 V to +10 V)

11.17 U: Monitors

No. (Hex.)	Name	Description	MFAO Signal Level
U1-10 (0049)	Input Terminal Status	<p>V/f CL-V/f OLV CLV AOLV OLV/PM AOLV/PM CLV/PM EZOLV</p> <p>Shows the status of the MFDI terminal where 1 = (ON) and 0 = (OFF). For example, U1-10 shows "00000011" when terminals S1 and S2 are ON. bit0 : Terminal S1 (MFDI 1) bit1 : Terminal S2 (MFDI 2) bit2 : Terminal S3 (MFDI 3) bit3 : Terminal S4 (MFDI 4) bit4 : Terminal S5 (MFDI 5) bit5 : Terminal S6 (MFDI 6) bit6 : Terminal S7 (MFDI 7) bit7 : Terminal S8 (MFDI 8)</p>	No signal output available
U1-11 (004A)	Output Terminal Status	<p>V/f CL-V/f OLV CLV AOLV OLV/PM AOLV/PM CLV/PM EZOLV</p> <p>Shows the status of the MFDO terminal where 1 = (ON) and 0 = (OFF). For example, U1-11 shows "00000011" when terminals M1 and M3 are ON. Note: When H2-xx = 100 to 19F [Inverse Output of Function], the value before inversion is displayed. bit 0 : Terminals M1-M2 bit 1 : Terminals M3-M4 bit 2 : Terminals M5-M6 bit 3 : Not used (normal value of 0). bit 4 : Not used (normal value of 0). bit 5 : Not used (normal value of 0). bit 6 : Not used (normal value of 0). bit 7 : Fault relay MA/MB-MC</p>	No signal output available
U1-12 (004B)	Drive Status	<p>V/f CL-V/f OLV CLV AOLV OLV/PM AOLV/PM CLV/PM EZOLV</p> <p>Shows drive status where 1 = (ON) and 0 = (OFF). For example, U1-12 shows "00000101" during run with the Reverse Run command. bit 0 : During Run bit 1 : During zero-speed bit 2 : During reverse bit 3 : During fault reset signal input bit 4 : During speed agreement bit 5 : Drive ready bit 6 : During minor fault detection bit 7 : During fault detection</p>	No signal output available
U1-13 (004E)	Terminal A1 Level	<p>V/f CL-V/f OLV CLV AOLV OLV/PM AOLV/PM CLV/PM EZOLV</p> <p>Shows the signal level of terminal A1. Unit: 0.1%</p>	10 V = 100% (-10 V to +10 V)
U1-14 (004F)	Terminal A2 Level	<p>V/f CL-V/f OLV CLV AOLV OLV/PM AOLV/PM CLV/PM EZOLV</p> <p>Shows the signal level of terminal A2. Unit: 0.1%</p>	10 V = 100% (-10 V to +10 V)
U1-15 (0050)	Terminal A3 Level	<p>V/f CL-V/f OLV CLV AOLV OLV/PM AOLV/PM CLV/PM EZOLV</p> <p>Shows the signal level of terminal A3. Unit: 0.1%</p>	0 V = 100% (-10 V to +10 V)
U1-16 (0053)	SFS Output Frequency	<p>V/f CL-V/f OLV CLV AOLV OLV/PM AOLV/PM CLV/PM EZOLV</p> <p>Shows the output frequency after soft start. Shows the frequency with acceleration and deceleration times and S-curves. Parameter o1-03 [Keypad Display Unit Selection] sets the display units. Unit: 0.01 Hz</p>	10 V = Maximum frequency (-10 V to +10 V)
U1-17 (0058)	DI-A3 Input Status	<p>V/f CL-V/f OLV CLV AOLV OLV/PM AOLV/PM CLV/PM EZOLV</p> <p>Shows the reference value input from DI-A3 option. Shows the input signal for DI-A3 in hexadecimal as set in F3-01 [Digital Input Function Selection]. 3FFFF: Set (1 bit) + Sign (1 bit) + 16 bit</p>	No signal output available
U1-18 (0061)	oPE Fault Parameter	<p>V/f CL-V/f OLV CLV AOLV OLV/PM AOLV/PM CLV/PM EZOLV</p> <p>Shows the parameter number that caused the oPE02 [Parameter Range Setting Error] or oPE08 [Parameter Selection Error].</p>	No signal output available

No. (Hex.)	Name	Description	MFAO Signal Level
U1-19 (0066)	MEMOBUS/Modbus Error Code	<p>V/f CL-V/f OLV CLV AOLV OLV/PM AOLV/PM CLV/PM EZOLV</p> <p>Shows the contents of the MEMOBUS/Modbus communication error where 1 = (error) and 0 = (no error). For example, <i>U1-19</i> shows "00000001" when a CRC error occurs. bit 0 : CRC Error bit 1 : Data Length Error bit 2 : Not used (normal value of 0). bit 3 : Parity Error bit 4 : Overrun Error bit 5 : Framing Error bit 6 : Timed Out bit 7 : Not used (normal value of 0).</p>	No signal output available
U1-21 (0077)	AI-A3 Term V1 Level	<p>V/f CL-V/f OLV CLV AOLV OLV/PM AOLV/PM CLV/PM EZOLV</p> <p>Shows the analog reference of terminal V1 on analog input option card AI-A3. Unit: 0.1%</p>	10 V = 100% (-10 V to +10 V)
U1-22 (072A)	AI-A3 Term V2 Level	<p>V/f CL-V/f OLV CLV AOLV OLV/PM AOLV/PM CLV/PM EZOLV</p> <p>Shows the analog reference of terminal V2 on analog input option card AI-A3. Unit: 0.1%</p>	10 V = 100% (-10 V to +10 V)
U1-23 (072B)	AI-A3 Term V3 Level	<p>V/f CL-V/f OLV CLV AOLV OLV/PM AOLV/PM CLV/PM EZOLV</p> <p>Shows the analog reference of terminal V3 on analog input option card AI-A3. Unit: 0.1%</p>	10 V = 100% (-10 V to +10 V)
U1-24 (007D)	Input Pulse Monitor	<p>V/f CL-V/f OLV CLV AOLV OLV/PM AOLV/PM CLV/PM EZOLV</p> <p>Shows the frequency to pulse train input terminal RP. Unit: 1 Hz</p>	Determined by H6-02
U1-25 (004D)	SoftwareNumber Flash	<p>V/f CL-V/f OLV CLV AOLV OLV/PM AOLV/PM CLV/PM EZOLV</p> <p>Shows the FLASH ID.</p>	No signal output available
U1-26 (005B)	SoftwareNumber ROM	<p>V/f CL-V/f OLV CLV AOLV OLV/PM AOLV/PM CLV/PM EZOLV</p> <p>Shows the ROM ID.</p>	No signal output available
U1-50 (1199) Expert	Virtual Analog Input	<p>V/f CL-V/f OLV CLV AOLV OLV/PM AOLV/PM CLV/PM EZOLV</p> <p>Shows the virtual analog input value.</p>	Determined by H7-40
U1-91 (154E) Expert	Output Voltage	<p>V/f CL-V/f OLV CLV AOLV OLV/PM AOLV/PM CLV/PM EZOLV</p> <p>Shows the drive internal output voltage reference. Unit: 0.1 V</p>	200 V class: 10 V = 200 Vrms 400 V class: 10 V = 400 Vrms

◆ U2: Fault Trace

No. (Hex.)	Name	Description	MFAO Signal Level
U2-01 (0080)	Current Fault	<p>V/f CL-V/f OLV CLV AOLV OLV/PM AOLV/PM CLV/PM EZOLV</p> <p>Shows the fault that the drive has when viewing the monitor.</p>	No signal output available
U2-02 (0081)	Previous Fault	<p>V/f CL-V/f OLV CLV AOLV OLV/PM AOLV/PM CLV/PM EZOLV</p> <p>Shows the fault that occurred most recently.</p>	No signal output available
U2-03 (0082)	Freq Reference@Fault	<p>V/f CL-V/f OLV CLV AOLV OLV/PM AOLV/PM CLV/PM EZOLV</p> <p>Shows the frequency reference at the fault that occurred most recently. Use <i>U1-01 [Frequency Reference]</i> to monitor the actual frequency reference value. Unit: 0.01 Hz</p>	No signal output available
U2-04 (0083)	Output Freq @ Fault	<p>V/f CL-V/f OLV CLV AOLV OLV/PM AOLV/PM CLV/PM EZOLV</p> <p>Shows the output frequency at the fault that occurred most recently. Use <i>U1-02 [Output Frequency]</i> to monitor the actual output frequency. Unit: 0.01 Hz</p>	No signal output available

11.17 U: Monitors

No. (Hex.)	Name	Description	MFAO Signal Level
U2-05 (0084)	Output Current@Fault	<p>V/f CL-V/f OLV CLV AOLV OLV/PM AOLV/PM CLV/PM EZOLV</p> <p>Shows the output current at the fault that occurred most recently. Use <i>UI-03 [Output Current]</i> to monitor the actual output current. The keypad shows the value of <i>UI-03</i> in amperes (A). When looking at the monitor through MEMOBUS/Modbus communications, the current is "8192 = drive rated current (A)". Calculate the current from the monitor value that is in at MEMOBUS/Modbus communications using "Numerals being displayed / 8192 × drive rated current (A)". Unit: Determined by the drive model. • 0.01 A: 2004 to 2042, 4002 to 4023 • 0.1 A: 2056 to 2415, 4031 to 4720</p>	No signal output available
U2-06 (0085)	Motor Speed @ Fault	<p>V/f CL-V/f OLV CLV AOLV OLV/PM AOLV/PM CLV/PM EZOLV</p> <p>Shows the motor speed at the fault that occurred most recently. Use <i>UI-05 [Motor Speed]</i> to monitor the actual motor speed. Unit: 0.01 Hz</p>	No signal output available
U2-07 (0086)	Output Voltage@Fault	<p>V/f CL-V/f OLV CLV AOLV OLV/PM AOLV/PM CLV/PM EZOLV</p> <p>Shows the output voltage reference at the fault that occurred most recently. Use <i>UI-06 [Output Voltage Ref]</i> to monitor the actual output voltage reference. Unit: 0.1 V</p>	No signal output available
U2-08 (0087)	DC Bus Voltage@Fault	<p>V/f CL-V/f OLV CLV AOLV OLV/PM AOLV/PM CLV/PM EZOLV</p> <p>Shows the DC bus voltage at the fault that occurred most recently. Use <i>UI-07 [DC Bus Voltage]</i> to monitor the actual DC bus voltage. Unit: 1 V</p>	No signal output available
U2-09 (0088)	Output Power @ Fault	<p>V/f CL-V/f OLV CLV AOLV OLV/PM AOLV/PM CLV/PM EZOLV</p> <p>Shows the output power at the fault that occurred most recently. Use <i>UI-08 [Output Power]</i> to monitor the actual output power. Unit: 0.1 kW</p>	No signal output available
U2-10 (0089)	Torque Ref @ Fault	<p>V/f CL-V/f OLV CLV AOLV OLV/PM AOLV/PM CLV/PM EZOLV</p> <p>Shows the torque reference at the fault that occurred most recently as a percentage of the motor rated torque. Use <i>UI-09 [Torque Reference]</i> to monitor the actual torque reference. Unit: 0.1%</p>	No signal output available
U2-11 (008A)	Input Terminal Status @ Fault	<p>V/f CL-V/f OLV CLV AOLV OLV/PM AOLV/PM CLV/PM EZOLV</p> <p>Shows the status of the MFDI terminals at the most recent fault where 1 = (ON) and 0 = (OFF). For example, <i>U2-11</i> shows "00000011" when terminals S1 and S2 are ON. Use <i>UI-10 [Input Terminal Status]</i> to monitor the actual MFDI terminal status. bit 0 : Terminal S1 bit 1 : Terminal S2 bit 2 : Terminal S3 bit 3 : Terminal S4 bit 4 : Terminal S5 bit 5 : Terminal S6 bit 6 : Terminal S7 bit 7 : Terminal S8</p>	No signal output available
U2-12 (008B)	Output Terminal Status @ Fault	<p>V/f CL-V/f OLV CLV AOLV OLV/PM AOLV/PM CLV/PM EZOLV</p> <p>Shows the status of the MFDO terminals at the most recent fault where 1 = (ON) and 0 = (OFF). For example, <i>U2-12</i> shows "00000011" when terminals M1 and M3 are ON. Use <i>UI-11 [Output Terminal Status]</i> to monitor the actual MFDO terminal status. bit 0 : Terminals M1-M2 bit 1 : Terminals M3-M4 bit 2 : Terminals M5-M6 bit 3 : Not used (normal value of 0). bit 4 : Not used (normal value of 0). bit 5 : Not used (normal value of 0). bit 6 : Not used (normal value of 0). bit 7 : Fault relay MA/MB-MC</p>	No signal output available

No. (Hex.)	Name	Description	MFAO Signal Level
U2-13 (008C)	Operation Status @ Fault	<p>V/f CL-V/f OLV CLV AOLV OLV/PM AOLV/PM CLV/PM EZOLV</p> <p>Shows the status of the MFDO terminals at the most recent fault where 1 = (ON) and 0 = (OFF). For example, U2-13 shows "00000001" during run. Use U1-12 [Drive Status] to monitor the actual MFDO terminal status.</p> <p>bit 0 : During Run bit 1 : During zero-speed bit 2 : During reverse bit 3 : During fault reset signal input bit 4 : During speed agreement bit 5 : Drive ready bit 6 : During minor fault detection bit 7 : During fault detection</p>	No signal output available
U2-14 (008D)	Elapsed Time @ Fault	<p>V/f CL-V/f OLV CLV AOLV OLV/PM AOLV/PM CLV/PM EZOLV</p> <p>Shows the cumulative operation time of the drive at the fault that occurred most recently. Use U4-01 [Cumulative Ope Time] to monitor the actual cumulative operation time. Unit: 1 h</p>	No signal output available
U2-15 (07E0)	SFS Output @ Fault	<p>V/f CL-V/f OLV CLV AOLV OLV/PM AOLV/PM CLV/PM EZOLV</p> <p>Shows the output frequency after soft start at the fault that occurred most recently. Use U1-16 [SFS Output Frequency] to monitor the actual output frequency after soft start. Unit: 0.01 Hz</p>	No signal output available
U2-16 (07E1)	q-Axis Current@Fault	<p>V/f CL-V/f OLV CLV AOLV OLV/PM AOLV/PM CLV/PM EZOLV</p> <p>Shows the q-axis current of the motor at the fault that occurred most recently. Use U6-01 [Iq Secondary Current] to monitor the actual q-Axis current of the motor. Unit: 0.1 %</p>	No signal output available
U2-17 (07E2)	d-Axis Current@Fault	<p>V/f CL-V/f OLV CLV AOLV OLV/PM AOLV/PM CLV/PM EZOLV</p> <p>Shows the d-axis current of the motor at the fault that occurred most recently. Use U6-02 [Id Excitation Current] to monitor the actual d-Axis current of the motor. Unit: 0.1 %</p>	No signal output available
U2-19 (07E4)	ControlDeviation@Flt	<p>V/f CL-V/f OLV CLV AOLV OLV/PM AOLV/PM CLV/PM EZOLV</p> <p>Shows the amount of control axis deviation ($\Delta\theta$) at the fault that occurred most recently. Use U6-10 [ContAxisDeviation $\Delta\theta$] to monitor the actual amount of control axis deviation ($\Delta\theta$). Unit: 0.1 °</p>	No signal output available
U2-20 (008E)	Heatsink Temp @Fault	<p>V/f CL-V/f OLV CLV AOLV OLV/PM AOLV/PM CLV/PM EZOLV</p> <p>Shows the heatsink temperature at the fault that occurred most recently. Use U4-08 [Heatsink Temperature] to monitor the actual temperature of the heatsink. Unit: 1 °C</p>	No signal output available
U2-21 (1166) Expert	STPo Detect @ Fault	<p>V/f CL-V/f OLV CLV AOLV OLV/PM AOLV/PM CLV/PM EZOLV</p> <p>Monitors conditions to detect STPo [Motor Step-Out Detected] faults. The bit for each condition is displayed as ON or OFF.</p> <p>bit 0 : Excessive current bit 1 : Induced voltage deviation bit 2 : d-axis current deviation bit 3 : Motor lock at startup bit 4 : Acceleration stall continue bit 5 : Acceleration stall repeat bit 6 : Not used (normal value of 0). bit 7 : Not used (normal value of 0).</p>	No signal output available

◆ U3: Fault History

No. (Hex.)	Name	Description	MFAO Signal Level
U3-01 to U3-04 (0090 - 0093) (0800 - 0803)	1st to 4th MostRecent Fault	<p>V/f CL-V/f OLV CLV AOLV OLV/PM AOLV/PM CLV/PM EZOLV</p> <p>Shows the fault history of the first to fourth most recent faults.</p> <p>Note: The drive saves the U3-01 to U3-04 [1st to 4th MostRecent Fault] fault histories to two types of registers at the same time for the MEMOBUS/Modbus communications.</p>	No signal output available
U3-05 to U3-10 (0804 - 0809)	5th to 10th MostRecent Fault	<p>V/f CL-V/f OLV CLV AOLV OLV/PM AOLV/PM CLV/PM EZOLV</p> <p>Shows the fault history of the fifth to tenth most recent faults.</p>	No signal output available

No. (Hex.)	Name	Description	MFAO Signal Level
U3-11 to U3-14 (0094 - 0097) (080A - 080D)	ElapsedTime@1st to 4thFault	<p>V/f CL-V/f OLV CLV AOLV OLV/PM AOLV/PM CLV/PM EZOLV</p> <p>Shows the cumulative operation time when the first to fourth most recent faults occurred. Unit: 1 h Note: The drive saves the U3-11 to U3-14 [ElapsedTime@1st to 4thFault] the cumulative operation time to two types of registers at the same time for the MEMOBUS/Modbus communications.</p>	No signal output available
U3-15 to U3-20 (080E - 0813)	ElapsedTime@5th to 10thFault	<p>V/f CL-V/f OLV CLV AOLV OLV/PM AOLV/PM CLV/PM EZOLV</p> <p>Shows the cumulative operation time when the fifth to tenth most recent faults occurred. Unit: 1 h</p>	No signal output available

◆ U4: Maintenance Monitors

No. (Hex.)	Name	Description	MFAO Signal Level
U4-01 (004C)	Cumulative Ope Time	<p>V/f CL-V/f OLV CLV AOLV OLV/PM AOLV/PM CLV/PM EZOLV</p> <p>Shows the cumulative operation time of the drive. Use parameter o4-01 [Elapsed Operating Time Setting] to reset this monitor. Use parameter o4-02 [Elapsed Operating Time Selection] to select the cumulative operation times from: <ul style="list-style-type: none"> The time from when the drive is energized until it is de-energized. The time at which the Run command is turned ON. The maximum value that the monitor will show is 99999. After this value is more than 99999, the drive automatically resets it and starts to count from 0 again. Unit: 1 h Note: The MEMOBUS/Modbus communication data is shown in 10 h units. Use register 0099H for data in 1 h units.</p>	10 V: 99999 h
U4-02 (0075)	Num of Run Commands	<p>V/f CL-V/f OLV CLV AOLV OLV/PM AOLV/PM CLV/PM EZOLV</p> <p>Shows how many times that the drive has received a Run command. Use parameter o4-13 [RUN Command Counter @ Initialize] to reset this monitor. The maximum value that the monitor will show is 65535. After this value is more than 65535, the drive automatically resets it and starts to count from 0 again. Unit: 1</p>	10 V: 65535 times
U4-03 (0067)	Cooling Fan Ope Time	<p>V/f CL-V/f OLV CLV AOLV OLV/PM AOLV/PM CLV/PM EZOLV</p> <p>Shows the cumulative operation time of the cooling fans. Use parameter o4-03 [Fan Operation Time Setting] to reset this monitor. The maximum value that the monitor will show is 99999. After this value is more than 99999, the drive automatically resets it and starts to count from 0 again. Unit: 1 h Note: The MEMOBUS/Modbus communication data is shown in 10 h units. Use register 009BH for data in 1 h units.</p>	10 V: 99999 h
U4-04 (007E)	Cool Fan Maintenance	<p>V/f CL-V/f OLV CLV AOLV OLV/PM AOLV/PM CLV/PM EZOLV</p> <p>Shows the cumulative operation time of the cooling fans as a percentage of the replacement life of the cooling fans. Use parameter o4-03 [Fan Operation Time Setting] to reset this monitor. Unit: 1% Note: Replace the cooling fans when this monitor is 90%.</p>	10 V: 100%
U4-05 (007C)	CapacitorMaintenance	<p>V/f CL-V/f OLV CLV AOLV OLV/PM AOLV/PM CLV/PM EZOLV</p> <p>Shows the operation time of the electrolytic capacitors for the main circuit and control circuit as a percentage of the replacement life of the electrolytic capacitors. Use parameter o4-05 [Capacitor Maintenance Setting] to reset this monitor. Unit: 1% Note: Replace the electrolytic capacitor when this monitor is 90%.</p>	10 V: 100%
U4-06 (07D6)	PreChargeRelayMainte	<p>V/f CL-V/f OLV CLV AOLV OLV/PM AOLV/PM CLV/PM EZOLV</p> <p>Shows the operation time of the soft charge bypass relay as a percentage of the replacement life of the soft charge bypass relay. Use parameter o4-07 [Softcharge Relay Maintenance Set] to reset this monitor. Unit: 1% Note: Replace the drive when this monitor is 90%.</p>	10 V: 100%

No. (Hex.)	Name	Description	MFAO Signal Level
U4-07 (07D7)	IGBT Maintenance	<p>V/f CL-V/f OLV CLV AOLV OLV/PM AOLV/PM CLV/PM EZOLV</p> <p>Shows the operation time of the IGBTs as a percentage of the replacement life of the IGBTs. Set parameter <i>o4-09</i> [IGBT Maintenance Setting] to reset this monitor. Unit: 1% Note: Replace the drive when this monitor is 90%.</p>	10 V: 100%
U4-08 (0068)	Heatsink Temperature	<p>V/f CL-V/f OLV CLV AOLV OLV/PM AOLV/PM CLV/PM EZOLV</p> <p>Shows the heatsink temperature of the drive. Unit: 1 °C</p>	10 V: 100 °C
U4-09 (005E)	LED Check	<p>V/f CL-V/f OLV CLV AOLV OLV/PM AOLV/PM CLV/PM EZOLV</p> <p>Turns on the LED Status Ring and all of the keypad LEDs to make sure that the LEDs operate correctly. Note: A damaged LED Status Ring board will prevent an accurate estimate of the internal status of the drive. Do not use only the LED Status Ring to estimate the status of the drive and motors. 1. Set <i>o2-24</i> = 0 [LED Light Function Selection = Enable Status Ring & Keypad LED]. 2. Push  with <i>U4-09</i> shown on the keypad. All LEDs on the keypad and LED Status Ring will turn on. Note: When Safety input 2 CH is open (STo), READY will flash.</p>	No signal output available
U4-10 (005C)	kWh, Lower 4 Digits	<p>V/f CL-V/f OLV CLV AOLV OLV/PM AOLV/PM CLV/PM EZOLV</p> <p>Displays the lower 4 digits of the watt hour value for the drive. Unit: 1 kWh Note: The watt hour is displayed in 9 digits. Monitor <i>U4-11</i> [kWh, Upper 5 Digits] shows the upper 5 digits and <i>U4-10</i> shows the lower 4 digits. Example for 12345678.9 kWh: <i>U4-10</i>: 678.9 kWh <i>U4-11</i>: 12345 MWh</p>	No signal output available
U4-11 (005D)	kWh, Upper 5 Digits	<p>V/f CL-V/f OLV CLV AOLV OLV/PM AOLV/PM CLV/PM EZOLV</p> <p>Shows the upper 5 digits of the watt hour value for the drive. Unit: 1 MWh Note: Monitor <i>U4-11</i> shows the upper 5 digits and <i>U4-10</i> [kWh, Lower 4 Digits] shows the lower 4 digits. Example for 12345678.9 kWh: <i>U4-10</i>: 678.9 kWh <i>U4-11</i>: 12345 MWh</p>	No signal output available
U4-13 (07CF)	Peak Hold Current	<p>V/f CL-V/f OLV CLV AOLV OLV/PM AOLV/PM CLV/PM EZOLV</p> <p>Shows the hold value of the peak value (rms) for the drive output current. Use <i>U4-14</i> [PeakHold Output Freq] to show the drive output frequency at the time that the drive holds the output current. The drive will hold the peak hold current at the next start up and restart of the power supply. The drive keeps the held value during baseblock (during stop). The keypad shows the value of <i>U4-13</i> in amperes (A). When looking at the monitor through MEMOBUS/Modbus communications, the current is "8192 = drive rated current (A)." Calculate the current from the monitor value that is in at MEMOBUS/Modbus communications using "Numerals being displayed / 8192 × drive rated current (A)." Unit: Determined by the drive model. • 0.01 A: 2004 to 2042, 4002 to 4023 • 0.1 A: 2056 to 2415, 4031 to 4720</p>	No signal output available
U4-14 (07D0)	PeakHold Output Freq	<p>V/f CL-V/f OLV CLV AOLV OLV/PM AOLV/PM CLV/PM EZOLV</p> <p>Displays the output frequency at which the peak value (rms) of the drive output current is held. The peak hold current can be monitored by <i>U4-13</i> [Peak Hold Current]. The peak hold output frequency will be cleared at the next startup and restart of the power supply. The drive keeps the value that was under hold during baseblock (during stop). Unit: 0.01 Hz</p>	No signal output available
U4-16 (07D8)	Motor oL1 Level	<p>V/f CL-V/f OLV CLV AOLV OLV/PM AOLV/PM CLV/PM EZOLV</p> <p>Shows the integrated value of <i>oL1</i> [Motor Overload] as a percentage of <i>oL1</i> detection level. Unit: 0.1%</p>	10 V: 100%

No. (Hex.)	Name	Description	MFAO Signal Level
U4-18 (07DA)	Reference Source	<p>V/f CL-V/f OLV CLV AOLV OLV/PM AOLV/PM CLV/PM EZOLV</p> <p>Shows the selected frequency reference source. The keypad shows the frequency reference source as "XY-<i>nn</i>" as specified by these rules: X: <i>External Reference 1/2 Selection [H1-xx = 2]</i> selection status</p> <ul style="list-style-type: none"> • 1: <i>b1-01 [Frequency Reference Selection 1]</i> • 2: <i>b1-15 [Frequency Reference Selection 2]</i> <p>Y-<i>nn</i>: Frequency reference source</p> <ul style="list-style-type: none"> • 0-01: Keypad (<i>d1-01 [Reference 1]</i>) • 1-00: Analog input (unassigned) • 1-01: MFAI terminal A1 • 1-02: MFAI terminal A2 • 1-03: MFAI terminal A3 • 2-02 to 2-17: Multi-step speed reference (<i>d1-02 to d1-17 [Reference 2 to 16, Jog Reference]</i>) • 3-01: MEMOBUS/Modbus communications • 4-01: Communication option card • 5-01: Pulse train input • 7-01: DriveWorksEZ • 9-01: Up/Down command 	No signal output available
U4-19 (07DB)	Modbus FreqRef (dec)	<p>V/f CL-V/f OLV CLV AOLV OLV/PM AOLV/PM CLV/PM EZOLV</p> <p>Shows the frequency reference sent to the drive from the MEMOBUS/Modbus communications as a decimal. Unit: 0.01%</p>	10 V = Maximum frequency (-10 V to +10 V)
U4-20 (07DC)	Option Freq Ref(dec)	<p>V/f CL-V/f OLV CLV AOLV OLV/PM AOLV/PM CLV/PM EZOLV</p> <p>Shows the frequency reference sent to the drive from the communication option as a decimal.</p>	10 V = Maximum frequency (-10 V to +10 V)
U4-21 (07DD)	Run Command Source	<p>V/f CL-V/f OLV CLV AOLV OLV/PM AOLV/PM CLV/PM EZOLV</p> <p>Shows the selected Run command source. The keypad shows the Run command source as "XY-<i>nn</i>" as specified by these rules: X: <i>External Reference 1/2 Selection [H1-xx = 2]</i> selection status</p> <ul style="list-style-type: none"> • 1: <i>b1-02 [Run Command Selection 1]</i> • 2: <i>b1-16 [Run Command Selection 2]</i> <p>Y: Run command source</p> <ul style="list-style-type: none"> • 0: Keypad • 1: Control circuit terminal • 3: MEMOBUS/Modbus communications • 4: Communication option card • 7: DriveWorksEZ <p><i>nn</i>: Run command limit status data</p> <ul style="list-style-type: none"> • 00: No limit status. • 01: The Run command was left ON when the drive stopped in the Programming Mode. • 02: The Run command was left ON when switching from LOCAL Mode to REMOTE Mode. • 03: The Run command is in standby after the drive was energized until the soft charge bypass contactor turns ON. <p>Note: The drive will detect <i>Uv1 [DC Bus Undervoltage]</i> or <i>Uv [Undervoltage]</i> if the soft charge bypass contactor does not turn ON after 10 s.</p> <ul style="list-style-type: none"> • 04: Restart after run stop is prohibited. • 05: Fast stop has been executed using the MFDI terminal. Or, the motor has ramped to stop by pressing the STOP key on the keypad. • 06: <i>b1-17 = 0 [Run Command at Power Up = Disregard Existing RUN Command]</i> is set. • 07: During baseblock while coast to stop with timer. • 08: Frequency reference is below <i>E1-09 [Minimum Output Frequency]</i> during baseblock. • 09: Waiting for the Enter command from PLC. 	No signal output The keypad shows the Run command source as "XY- <i>nn</i> " as specified by these rules: available

No. (Hex.)	Name	Description	MFAO Signal Level
U4-22 (07DE)	Modbus CmdData (hex)	<p>V/f CL-V/f OLV CLV AOLV OLV/PM AOLV/PM CLV/PM EZOLV</p> <p>Shows the operation signal (register 0001H) sent to the drive from MEMOBUS/Modbus communications as a 4-digit hexadecimal number (zero suppress). The keypad shows the operation signal as specified by these rules:</p> <p>bit 0 : Forward run/Stop bit 1 : Reverse run/Stop bit 2 : External fault bit 3 : Fault Reset bit 4 : Multi-function input 1 bit 5 : Multi-function input 2 bit 6 : Multi-function input 3 bit 7 : Multi-function input 4 bit 8 : Multi-function input 5 bit 9 : Multi-function input 6 bit A : Multi-function input 7 bit B : Multi-function input 8 bit C : Not used (normal value of 0). bit D : Not used (normal value of 0). bit E : Not used (normal value of 0). bit F : Not used (normal value of 0).</p>	No signal output available
U4-23 (07DF)	Option CmdData (hex)	<p>V/f CL-V/f OLV CLV AOLV OLV/PM AOLV/PM CLV/PM EZOLV</p> <p>Shows the operation signal (register 0001H) sent to the drive from MEMOBUS/Modbus communications as a 4-digit hexadecimal number. The keypad shows the operation signal as specified by these rules:</p> <p>bit 0 : Forward run/Stop bit 1 : Reverse run/Stop bit 2 : External fault bit 3 : Fault Reset bit 4 : Multi-function input 1 bit 5 : Multi-function input 2 bit 6 : Multi-function input 3 bit 7 : Multi-function input 4 bit 8 : Multi-function input 5 bit 9 : Multi-function input 6 bit A : Multi-function input 7 bit B : Multi-function input 8 bit C : Not used (normal value of 0). bit D : Not used (normal value of 0). bit E : Not used (normal value of 0). bit F : Not used (normal value of 0).</p>	No signal output available
U4-24 (07E6)	Number of Runs (Low)	<p>V/f CL-V/f OLV CLV AOLV OLV/PM AOLV/PM CLV/PM EZOLV</p> <p>Shows the lower 4 digits of the drive run count.</p> <p>Note: The drive run count appears as an 8-digit number. Monitor <i>U4-25 [Number of Runs(High)]</i> shows the upper 4 digits and <i>U4-24</i> shows the lower 4 digits.</p>	No signal output available
U4-25 (07E7)	Number of Runs(High)	<p>V/f CL-V/f OLV CLV AOLV OLV/PM AOLV/PM CLV/PM EZOLV</p> <p>Shows the lower 4 digits of the drive run count.</p> <p>Note: The drive run count appears as an 8-digit number. Monitor <i>U4-25</i> shows the upper 4 digits and <i>U4-24 [Number of Runs (Low)]</i> shows the lower 4 digits.</p>	No signal output available
U4-52 (1592)	Torque Ref from Comm	<p>V/f CL-V/f OLV CLV AOLV OLV/PM AOLV/PM CLV/PM EZOLV</p> <p>Displays the torque reference given to the drive via a serial communication option card or via MEMOBUS/Modbus communications as a decimal number.</p> <p>Unit: 0.1%</p>	10 V = 100% (-10 V to +10 V)

◆ U5: PID Monitors

No. (Hex.)	Name	Description	MFAO Signal Level
U5-01 (0057)	PID Feedback	V/f CL-V/f OLV CLV AOLV OLV/PM AOLV/PM CLV/PM EZOLV Shows the PID control feedback value. Parameter <i>b5-20 [PID Unit Selection]</i> sets the display units. Unit: 0.01%	10 V = Maximum frequency (-10 V to +10 V)
U5-02 (0063)	PID Input	V/f CL-V/f OLV CLV AOLV OLV/PM AOLV/PM CLV/PM EZOLV Shows the change between the PID setpoint and PID feedback (the quantity of PID input) as a percentage of the maximum output frequency. Unit: 0.01%	10 V = Maximum frequency (-10 V to +10 V)
U5-03 (0064)	PID Output	V/f CL-V/f OLV CLV AOLV OLV/PM AOLV/PM CLV/PM EZOLV Shows the PID control output as a percentage of the maximum output frequency. Unit: 0.01%	10 V = Maximum frequency (-10 V to +10 V)
U5-04 (0065)	PID Setpoint	V/f CL-V/f OLV CLV AOLV OLV/PM AOLV/PM CLV/PM EZOLV Shows the PID setpoint. Parameter <i>b5-20 [PID Unit Selection]</i> sets the display units. Unit: 0.01%	10 V = Maximum frequency (-10 V to +10 V)
U5-05 (07D2)	PID DifferentialFdbk	V/f CL-V/f OLV CLV AOLV OLV/PM AOLV/PM CLV/PM EZOLV Shows the PID differential feedback value as a percentage of the maximum output frequency. This monitor is available after you set <i>H3-02, H3-10, or H3-06 = 16 [MFAI Function Selection = Differential PID Feedback]</i> . Unit: 0.01%	10 V = Maximum frequency (-10 V to +10 V)
U5-06 (07D3)	PID Fdbk-Diff PID Fdbk	V/f CL-V/f OLV CLV AOLV OLV/PM AOLV/PM CLV/PM EZOLV Shows the difference from calculating <i>U5-05 - U5-01 [PID DifferentialFdbk] - [PID Feedback]</i> . Unit: 0.01% Note: <i>U5-01 [PID Feedback] = U5-06 when H3-02, H3-10, or H3-06 ≠ 16 [MFAI Function Selection ≠ Differential PID Feedback]</i> .	10 V = Maximum frequency (-10 V to +10 V)
U5-21 (0872) Expert	Energy Save Coeff Ki	V/f CL-V/f OLV CLV AOLV OLV/PM AOLV/PM CLV/PM EZOLV Shows the energy-saving coefficient Ki value for PM. Unit: 0.01	No signal output available
U5-22 (0873) Expert	Energy Save Coeff Kt	V/f CL-V/f OLV CLV AOLV OLV/PM AOLV/PM CLV/PM EZOLV Shows the energy-saving coefficient Kt value for PM. Unit: 0.01	No signal output available
U5-99 (1599)	PID Setpoint Command	V/f CL-V/f OLV CLV AOLV OLV/PM AOLV/PM CLV/PM EZOLV Shows the PID setpoint command. Parameter <i>b5-20 [PID Unit Selection]</i> sets the display units. Unit: 0.01%	10 V = Maximum frequency (-10 V to +10 V)

◆ U6: Operation Status Monitors

No. (Hex.)	Name	Description	MFAO Signal Level
U6-01 (0051)	Iq Secondary Current	V/f CL-V/f OLV CLV AOLV OLV/PM AOLV/PM CLV/PM EZOLV Shows the value calculated for the motor secondary current (q axis) as a percentage of the motor rated secondary current. Unit: 0.1%	10 V = Motor secondary rated current (-10 V to +10 V)
U6-02 (0052)	Id ExcitationCurrent	V/f CL-V/f OLV CLV AOLV OLV/PM AOLV/PM CLV/PM EZOLV Shows the value calculated for the motor excitation current (d axis) as a percentage of the motor rated secondary current. Unit: 0.1%	10 V = Motor secondary rated current (-10 V to +10 V)
U6-03 (0054)	ASR Input	V/f CL-V/f OLV CLV AOLV OLV/PM AOLV/PM CLV/PM EZOLV Shows the ASR input value as a percentage of the maximum frequency. Unit: 0.01%	10 V = Maximum frequency (-10 V to +10 V)
U6-04 (0055)	ASR Output	V/f CL-V/f OLV CLV AOLV OLV/PM AOLV/PM CLV/PM EZOLV Shows the ASR output value as a percentage of the motor rated secondary current. Unit: 0.01%	10 V = Motor secondary rated current (-10 V to +10 V)
U6-05 (0059)	OutputVoltageRef: Vq	V/f CL-V/f OLV CLV AOLV OLV/PM AOLV/PM CLV/PM EZOLV Shows the drive internal voltage reference for motor secondary current control (q axis). Unit: 0.1 V	200 V class: 10 V = 200 Vrms 400 V class: 10 V = 400 Vrms (-10 V to +10 V)

No. (Hex.)	Name	Description	MFAO Signal Level
U6-06 (005A)	OutputVoltageRef: Vd	<input type="checkbox"/> V/f <input type="checkbox"/> CL-V/f <input checked="" type="checkbox"/> OLV <input checked="" type="checkbox"/> CLV <input type="checkbox"/> AOLV <input type="checkbox"/> OLV/PM <input type="checkbox"/> AOLV/PM <input type="checkbox"/> CLV/PM <input type="checkbox"/> EZOLV Shows the drive internal voltage reference for motor excitation current control (d axis). Unit: 0.1 V	200 V class: 10 V = 200 Vrms 400 V class: 10 V = 400 Vrms (-10 V to +10 V)
U6-07 (005F) Expert	q-Axis ACR Output	<input type="checkbox"/> V/f <input type="checkbox"/> CL-V/f <input checked="" type="checkbox"/> OLV <input checked="" type="checkbox"/> CLV <input type="checkbox"/> AOLV <input type="checkbox"/> OLV/PM <input type="checkbox"/> AOLV/PM <input type="checkbox"/> CLV/PM <input type="checkbox"/> EZOLV Shows the output value for current control related to motor secondary current (q axis). Unit: 0.1%	200 V class: 10 V = 200 Vrms 400 V class: 10 V = 400 Vrms (-10 V to +10 V)
U6-08 (0060) Expert	d-Axis ACR Output	<input type="checkbox"/> V/f <input type="checkbox"/> CL-V/f <input checked="" type="checkbox"/> OLV <input checked="" type="checkbox"/> CLV <input type="checkbox"/> AOLV <input type="checkbox"/> OLV/PM <input type="checkbox"/> AOLV/PM <input type="checkbox"/> CLV/PM <input type="checkbox"/> EZOLV Shows the output value for current control related to motor excitation current (d axis). Unit: 0.1%	200 V class: 10 V = 200 Vrms 400 V class: 10 V = 400 Vrms (-10 V to +10 V)
U6-09 (07C0) Expert	AdvPhase Compen $\Delta\theta_{cmp}$	<input type="checkbox"/> V/f <input type="checkbox"/> CL-V/f <input type="checkbox"/> OLV <input type="checkbox"/> CLV <input type="checkbox"/> AOLV <input type="checkbox"/> OLV/PM <input type="checkbox"/> AOLV/PM <input type="checkbox"/> CLV/PM <input type="checkbox"/> EZOLV Displays the data on forward phase compensation for the calculation results of the amount of control axis deviation. Unit: 1 °	10 V: 180 ° (-10 V to +10 V)
U6-10 (07C1) Expert	ContAxisDeviation $\Delta\theta$	<input type="checkbox"/> V/f <input type="checkbox"/> CL-V/f <input type="checkbox"/> OLV <input type="checkbox"/> CLV <input type="checkbox"/> AOLV <input type="checkbox"/> OLV/PM <input type="checkbox"/> AOLV/PM <input type="checkbox"/> CLV/PM <input type="checkbox"/> EZOLV Shows the deviation between the $\gamma\delta$ -Axis used for motor control and the dq-Axis. Unit: 0.1 °	10 V: 180 ° (-10 V to +10 V)
U6-13 (07CA) Expert	MagPolePosition(Enc)	<input type="checkbox"/> V/f <input type="checkbox"/> CL-V/f <input type="checkbox"/> OLV <input type="checkbox"/> CLV <input type="checkbox"/> AOLV <input type="checkbox"/> OLV/PM <input type="checkbox"/> AOLV/PM <input type="checkbox"/> CLV/PM <input type="checkbox"/> EZOLV Shows the value of the flux position detection. Unit: 0.1 °	10 V: 180° (-10 V to +10 V)
U6-14 (07CB) Expert	MagPolePosition(Obs)	<input type="checkbox"/> V/f <input type="checkbox"/> CL-V/f <input type="checkbox"/> OLV <input type="checkbox"/> CLV <input type="checkbox"/> AOLV <input checked="" type="checkbox"/> OLV/PM <input type="checkbox"/> AOLV/PM <input type="checkbox"/> CLV/PM <input type="checkbox"/> EZOLV Shows the value of the flux position estimation. Unit: 0.1 °	10 V: 180 ° (-10 V to +10 V)
U6-17 (07D1) Expert	Energy Save Coeff	<input type="checkbox"/> V/f <input type="checkbox"/> CL-V/f <input type="checkbox"/> OLV <input type="checkbox"/> CLV <input type="checkbox"/> AOLV <input type="checkbox"/> OLV/PM <input type="checkbox"/> AOLV/PM <input type="checkbox"/> CLV/PM <input type="checkbox"/> EZOLV Shows the total time of direction of motor rotation detections for Speed Estimation Speed Searches. This value adjusts <i>b3-26 [Direction Determination Level]</i> . Note: Upper limit is +32767 and lower limit is -32767.	No signal output available
U6-18 (07CD)	Enc 1 Pulse Counter	<input type="checkbox"/> V/f <input type="checkbox"/> CL-V/f <input type="checkbox"/> OLV <input type="checkbox"/> CLV <input type="checkbox"/> AOLV <input type="checkbox"/> OLV/PM <input type="checkbox"/> AOLV/PM <input type="checkbox"/> CLV/PM <input type="checkbox"/> EZOLV Shows the number of pulses for speed detection (PG1). Unit: 1 pulse	10 V: 65536
U6-19 (07E5)	Enc 2 Pulse Counter	<input type="checkbox"/> V/f <input type="checkbox"/> CL-V/f <input type="checkbox"/> OLV <input type="checkbox"/> CLV <input type="checkbox"/> AOLV <input type="checkbox"/> OLV/PM <input type="checkbox"/> AOLV/PM <input type="checkbox"/> CLV/PM <input type="checkbox"/> EZOLV Shows the number of pulses for speed detection (PG2). Unit: 1 pulse	10 V: 65536
U6-20 (07D4)	UP/DOWN 2 Bias Value	<input type="checkbox"/> V/f <input type="checkbox"/> CL-V/f <input type="checkbox"/> OLV <input type="checkbox"/> CLV <input type="checkbox"/> AOLV <input type="checkbox"/> OLV/PM <input type="checkbox"/> AOLV/PM <input type="checkbox"/> CLV/PM <input type="checkbox"/> EZOLV Shows the bias value used to adjust the frequency reference. Unit: 0.1%	10 V: Maximum Frequency
U6-21 (07D5)	Offset Frequency	<input type="checkbox"/> V/f <input type="checkbox"/> CL-V/f <input type="checkbox"/> OLV <input type="checkbox"/> CLV <input type="checkbox"/> AOLV <input type="checkbox"/> OLV/PM <input type="checkbox"/> AOLV/PM <input type="checkbox"/> CLV/PM <input type="checkbox"/> EZOLV Shows the total value of <i>d7-01 to d7-03 [Offset Frequency 1 to 3]</i> selected with <i>Add Offset Frequency 1 to 3 [H1-xx = 44 to 46]</i> . Unit: 0.1%	10 V: Maximum Frequency
U6-22 (0062)	ZeroServo Pulse Move	<input type="checkbox"/> V/f <input type="checkbox"/> CL-V/f <input type="checkbox"/> OLV <input type="checkbox"/> CLV <input type="checkbox"/> AOLV <input type="checkbox"/> OLV/PM <input type="checkbox"/> AOLV/PM <input type="checkbox"/> CLV/PM <input type="checkbox"/> EZOLV Shows the distance that the rotor moved from its last position when Zero Servo is available. The value shown in this monitor = 4 X [No. of PG pulses]. Unit: 1 pulse	10 V = Number of pulses per revolution (-10 V to +10 V)
U6-25 (006B) Expert	ASR Output Level	<input type="checkbox"/> V/f <input type="checkbox"/> CL-V/f <input type="checkbox"/> OLV <input type="checkbox"/> CLV <input type="checkbox"/> AOLV <input type="checkbox"/> OLV/PM <input type="checkbox"/> AOLV/PM <input type="checkbox"/> CLV/PM <input type="checkbox"/> EZOLV Shows the primary delay filter input value of the ASR (speed control loop). Unit: 0.01%	10 V = Motor secondary rated current (-10 V to +10 V)
U6-26 (006C) Expert	Feed Fwd Cont Output	<input type="checkbox"/> V/f <input type="checkbox"/> CL-V/f <input type="checkbox"/> OLV <input type="checkbox"/> CLV <input type="checkbox"/> AOLV <input type="checkbox"/> OLV/PM <input type="checkbox"/> AOLV/PM <input type="checkbox"/> CLV/PM <input type="checkbox"/> EZOLV Shows the Feed Forward control output. Unit: 0.01%	10 V = Motor secondary rated current (-10 V to +10 V)
U6-27 (006D) Expert	FeedFwd Estimate Spd	<input type="checkbox"/> V/f <input type="checkbox"/> CL-V/f <input type="checkbox"/> OLV <input type="checkbox"/> CLV <input type="checkbox"/> AOLV <input type="checkbox"/> OLV/PM <input type="checkbox"/> AOLV/PM <input type="checkbox"/> CLV/PM <input type="checkbox"/> EZOLV Shows the feed forward estimated speed. Unit: 0.01%	10 V = Maximum frequency (-10 V to +10 V)

11.17 U: Monitors

No. (Hex.)	Name	Description	MFAO Signal Level
U6-31 (007B)	TorqueDetect Monitor	<p>V/f CL-V/f OLV CLV AOLV OLV/PM AOLV/PM CLV/PM EZOLV</p> <p>Monitors the torque reference or the output current after applying the filter set to L6-07 [Torque Detection Filter Time]. Unit: 0.1%</p>	10 V:100%
U6-36 (0720) Expert	Comm Errors-Host	<p>V/f CL-V/f OLV CLV AOLV OLV/PM AOLV/PM CLV/PM EZOLV</p> <p>Shows the number of inter-CPU communication errors. De-energizing the drive sets this number to 0.</p>	No signal output available
U6-37 (0721) Expert	Comm Errors-Sensor	<p>V/f CL-V/f OLV CLV AOLV OLV/PM AOLV/PM CLV/PM EZOLV</p> <p>Shows the number of inter-CPU communication errors. De-energizing the drive sets this number to 0.</p>	No signal output available
U6-48 (072E) Expert	ASIC Comm Errors	<p>V/f CL-V/f OLV CLV AOLV OLV/PM AOLV/PM CLV/PM EZOLV</p> <p>Counts the number of inter-ASIC communication errors detected by the ASIC. This count is reset to 0 when the power to the drive is turned off.</p>	No signal output available
U6-57 (07C4)	PolePolarityDeterVal	<p>V/f CL-V/f OLV CLV AOLV OLV/PM AOLV/PM CLV/PM EZOLV</p> <p>Shows the change from the integrated current when finding the polarity. Unit: 1</p> <p>Note: If the change from the integrated current is less than 819, increase n8-84 [Polarity Detection Current]. U6-57 = 8192 is equivalent to the motor rated current.</p>	No signal output available
U6-80 to U6-83 (07B0 - 07B3)	Option IP Address 1 to 4	<p>V/f CL-V/f OLV CLV AOLV OLV/PM AOLV/PM CLV/PM EZOLV</p> <p>Shows the currently available local IP Address.</p> <ul style="list-style-type: none"> • U6-80: 1st octet • U6-81: 2nd octet • U6-82: 3rd octet • U6-83: 4th octet 	No signal output available
U6-84 to U6-87 (07B4 - 07B7)	Online Subnets 1 to 4	<p>V/f CL-V/f OLV CLV AOLV OLV/PM AOLV/PM CLV/PM EZOLV</p> <p>Shows the currently available subnet mask.</p> <ul style="list-style-type: none"> • U6-84: 1st octet • U6-85: 2nd octet • U6-86: 3rd octet • U6-87: 4th octet 	No signal output available
U6-88 to U6-91 (07B8, 07B9, 07F0, 07F1)	Online Gateways 1 to 4	<p>V/f CL-V/f OLV CLV AOLV OLV/PM AOLV/PM CLV/PM EZOLV</p> <p>Shows the currently available gateway address.</p> <ul style="list-style-type: none"> • U6-88: 1st octet • U6-89: 2nd octet • U6-90: 3rd octet • U6-91: 4th octet 	No signal output available
U6-92 (07F2)	Online Speed	<p>V/f CL-V/f OLV CLV AOLV OLV/PM AOLV/PM CLV/PM EZOLV</p> <p>Shows the currently available communications speed. 10: 10 Mbps 100: 100 Mbps</p>	No signal output available
U6-93 (07F3)	Online Duplex	<p>V/f CL-V/f OLV CLV AOLV OLV/PM AOLV/PM CLV/PM EZOLV</p> <p>Shows the currently available Duplex setting.</p>	No signal output available
U6-98 (07F8)	First Fault	<p>V/f CL-V/f OLV CLV AOLV OLV/PM AOLV/PM CLV/PM EZOLV</p> <p>Shows the contents of the most recent communication options fault (DeviceNet, Modbus TCP/IP, EtherNet/IP).</p>	No signal output available
U6-99 (07F9)	Current Fault	<p>V/f CL-V/f OLV CLV AOLV OLV/PM AOLV/PM CLV/PM EZOLV</p> <p>Shows the contents of current fault from communication options (DeviceNet, Modbus TCP/IP, EtherNet/IP).</p>	No signal output available

◆ U8: DriveWorksEZ Monitors

No. (Hex.)	Name	Description	MFAO Signal Level
U8-01 to U8-10 (1950 - 1959)	DWEZ Monitors 1 to 10	<p>V/f CL-V/f OLV CLV AOLV OLV/PM AOLV/PM CLV/PM EZOLV</p> <p>Shows DriveWorks EZ Monitors 1 to 10. Unit: 0.01%</p>	10 V = 100%
U8-11 (195A)	DWEZ Version 1	<p>V/f CL-V/f OLV CLV AOLV OLV/PM AOLV/PM CLV/PM EZOLV</p> <p>Displays the upper three digits of the user ID. When you open the setting screen by clicking the setting button on the PC tool title bar, the user ID can be confirmed with the ID display of the primary user.</p>	No signal output available
U8-12 (195B)	DWEZ Version 2	<p>V/f CL-V/f OLV CLV AOLV OLV/PM AOLV/PM CLV/PM EZOLV</p> <p>Displays the lower five digits of the user ID. When you open the setting screen by clicking the setting button on the PC tool title bar, the user ID can be confirmed with the ID display of the primary user.</p>	No signal output available
U8-13 (195C)	DWEZ Version 3	<p>V/f CL-V/f OLV CLV AOLV OLV/PM AOLV/PM CLV/PM EZOLV</p> <p>Displays the software ID.</p>	No signal output available
U8-18 (1961)	DWEZ Platform Ver	<p>V/f CL-V/f OLV CLV AOLV OLV/PM AOLV/PM CLV/PM EZOLV</p> <p>Shows the DriveWorksEZ platform version.</p>	No signal output available
U8-21 to U8-25 (1964 - 1968)	DWEZ Monitors 21 to 25	<p>V/f CL-V/f OLV CLV AOLV OLV/PM AOLV/PM CLV/PM EZOLV</p> <p>Shows DriveWorks EZ Monitors 21 to 25. Unit: 0.01%</p>	10 V = 100%
U8-31 to U8-40 (196E - 1977)	DWEZ Monitors 31 to 40	<p>V/f CL-V/f OLV CLV AOLV OLV/PM AOLV/PM CLV/PM EZOLV</p> <p>Shows DriveWorks EZ Monitors 31 to 40. Unit: 0.01%</p>	10 V = 100%
U8-51 to U8-55 (1982 - 1986)	DWEZ Monitors 51 to 55	<p>V/f CL-V/f OLV CLV AOLV OLV/PM AOLV/PM CLV/PM EZOLV</p> <p>Shows DriveWorks EZ Monitors 51 to 55. Unit: 0.01%</p>	10 V = 100%

11.18 Parameters that Change from the Default Settings with A1-02 [Control Method Selection]

The values for the parameters in these tables depend on the values for parameter *A1-02*. When you change the setting for *A1-02*, the default settings will change.

◆ A1-02 = 0 to 4 [Induction Motor Control Methods]

No.	Name	Range	Unit	Control Method (A1-02 Setting)				
				V/f (0)	CL-V/f (1)	OLV (2)	CLV (3)	AOLV (4)
b2-01	DC Injection/Zero Speed Threshold	0.0 - 10.0	0.1 Hz	0.5	0.5	0.5	0.5	0.5
b2-04	DC Inject Braking Time at Stop	0.00 - 10.00	0.01 s	0.50	0.50	0.50	0.50	0.50
b3-01	Speed Search at Start Selection	0 - 1	1	0	1	0	-	0
b3-02	SpeedSearch Deactivation Current	0 - 200	1%	120	-	100	-	-
b3-08	Speed Estimation ACR P Gain	0.00 - 6.00	0.01	0.50 <i>*1</i>	0.50 <i>*1</i>	0.50 <i>*1</i>	0.50 <i>*1</i>	0.50 <i>*1</i>
b3-09	Speed Estimation ACR I Time	0.0 - 1000.0	0.1 ms	2.0	2.0	2.0	2.0	2.0
b3-14	Bi-directional Speed Search	0 - 1	1	0	0	0	-	1
b5-15	PID Sleep Function Start Level	0.0 - 400.0	0.1 Hz	0.0	0.0	0.0	0.0	0.0
b6-01	Dwell Reference at Start	0.0 - 400.0	0.1 Hz	0.0	0.0	0.0	0.0	0.0
b6-03	Dwell Reference at Stop	0.0 - 400.0	0.1 Hz	0.0	0.0	0.0	0.0	0.0
b8-02	Energy Saving Gain	0.0 - 10.0	0.1	-	-	0.7	1.0	1.0
b8-03	Energy Saving Filter Time	0.00 - 10.00	0.01 s	-	-	0.50 <i>*2</i>	0.01 <i>*2</i>	0.01 <i>*2</i>
b8-19	E-Save Search Injection Freq	10 - 300	1 Hz	-	-	-	-	-
C1-11	Accel/Decel Time Switchover Freq	0.0 - 400.0	0.1 Hz	0.0	0.0	0.0	0.0	0.0
C2-01	S-Curve Time @ Start of Accel	0.00 - 10.00	0.01 s	0.20	0.20	0.20	0.20	0.20
C3-01	Slip Compensation Gain	0.0 - 2.5	0.1	0.0	-	1.0	1.0	0.0
C3-02	Slip Compensation Delay Time	0 - 10000	1 ms	2000	-	200	-	-
C4-01	Torque Compensation Gain	0.00 - 2.50	0.01	1.00	1.00	1.00	-	-
C4-02	Torque Compensation Delay Time	0 - 60000	1 ms	200	200	20	-	-
C5-01	ASR Proportional Gain 1	0.00 - 300.00	0.01	-	0.20	-	20.00	10.00
C5-02	ASR Integral Time 1	0.000 - 60.000	0.001 s	-	0.200	-	0.500	0.500
C5-03	ASR Proportional Gain 2	0.00 - 300.00	0.01	-	0.02	-	20.00	20.00
C5-04	ASR Integral Time 2	0.000 - 60.000	0.001 s	-	0.050	-	0.500	0.500

11.18 Parameters that Change from the Default Settings with A1-02 [Control Method Selection]

No.	Name	Range	Unit	Control Method (A1-02 Setting)				
				V/f (0)	CL-V/f (1)	OLV (2)	CLV (3)	AOLV (4)
C5-06	ASR Delay Time	0.000 - 0.500	0.001 s	-	-	-	0.004	0.004
C5-07	ASR Gain Switchover Frequency	0.0 - 400.0	0.1 Hz	-	-	-	0.0	0.0
C6-02	Carrier Frequency Selection	1 - F	1	1 *3	1 *3	1 *3	1	1
d3-01	Jump Frequency 1	0.0 - 400.0	0.1 Hz	0.0	0.0	0.0	0.0	0.0
d3-02	Jump Frequency 2	0.0 - 400.0	0.1 Hz	0.0	0.0	0.0	0.0	0.0
d3-03	Jump Frequency 3	0.0 - 400.0	0.1 Hz	0.0	0.0	0.0	0.0	0.0
d3-04	Jump Frequency Width	0.0 - 20.0	0.1 Hz	1.0	1.0	1.0	1.0	1.0
d5-02	Torque Reference Delay Time	0 - 1000	1 ms	-	-	-	0	0
E1-04	Maximum Output Frequency	40.0 - 400.0 *3 *4	0.1 Hz	60.0 *5	60.0 *5	60.0	60.0	60.0
E1-05	Maximum Output Voltage	0.0 - 255.0 *6	0.1 V	200.0 *5	200.0 *5	200.0	200.0	200.0
E1-06	Base Frequency	0.0 - 400.0 *4	0.1 Hz	60.0 *5	60.0 *5	60.0	60.0	60.0
E1-07	Mid Point A Frequency	0.0 - 400.0 *4	0.1 Hz	3.0 *5	3.0 *5	3.0	-	0.0
E1-08	Mid Point A Voltage	0.0 - 255.0 *6	0.1 V	15.0 *5	15.0 *5	11.0	-	0.0
E1-09	Minimum Output Frequency	0.0 - 400.0 *4	0.1 Hz	1.5 *5	1.5 *5	0.5	0.0	0.0
E1-10	Minimum Output Voltage	0.0 - 255.0 *6	0.1 V	9.0 *5	9.0 *5	2.0	-	0.0
F1-01	Encoder 1 Pulse Count (PPR)	0 - 60000	1 ppr	-	600	-	600	600
F1-05	Encoder 1 Rotation Selection	0 - 1	1	-	0	-	0	0
F1-09	Overspeed Detection Delay Time	0.0 - 2.0	0.1 s	-	1.0	-	0.0	0.1
L1-01	Motor Overload (oL1) Protection	0 - 6	1	2	2	2	2	2
L2-31	KEB Start Voltage Offset Level	0 - 100 *6	1 V	0	0	0	0	0
L3-05	Stall Prevention during RUN	0 - 3	1	2	2	-	-	-
L3-20	DC Bus Voltage Adjustment Gain	0.00 - 5.00	0.01	1.00	1.00	0.30	0.30	0.30
L3-21	OVSuppression Accel/Decel P Gain	0.10 - 10.00	0.01	1.00	1.00	1.00	1.00	1.00
L3-36	Current Suppression Gain@Accel	0.0 - 100.0	0.1	10.0	10.0	20.0	-	-
L4-01	Speed Agree Detection Level	0.0 - 400.0 *7	0.1	0.0 Hz	0.0 Hz	0.0 Hz	0.0 Hz	0.0 Hz
L4-02	Speed Agree Detection Width	0.0 - 20.0	0.1	2.0 Hz	2.0 Hz	2.0 Hz	2.0 Hz	2.0 Hz
L4-03	Speed Agree Detection Level (+/-)	-400.0 - +400.0 *8	0.1	0.0 Hz	0.0 Hz	0.0 Hz	0.0 Hz	0.0 Hz
L4-04	Speed Agree Detection Width (+/-)	0.0 - 20.0	0.1	2.0 Hz	2.0 Hz	2.0 Hz	2.0 Hz	2.0 Hz

11.18 Parameters that Change from the Default Settings with A1-02 [Control Method Selection]

No.	Name	Range	Unit	Control Method (A1-02 Setting)				
				V/f (0)	CL-V/f (1)	OLV (2)	CLV (3)	AOLV (4)
L8-38	Carrier Frequency Reduction	0 - 2	1	*3	*3	*3	*3	-
L8-40	Carrier Freq Reduction Off-Delay	0.00 - 2.00	0.01 s	0.50	0.50	0.50	0.50	-
L8-90	STPo Detection Level (Low Speed)	0 - 5000	1	-	-	-	-	-
n1-15	PWM Voltage Offset Calibration	0 - 2	1	1	1	1	1	2
n5-04	Speed Response Frequency	0.00 - 500.00	0.01 Hz	-	-	-	50.00	50.00
n8-35	Initial Pole Detection Method	0 - 2	1	-	-	-	-	-
n8-51	Pull-in Current @ Acceleration	0 - 200	1%	-	-	-	-	-
o1-03	Frequency Display Unit Selection	0 - 3	1	0	0	0	0	0
o1-04	V/f Pattern Display Unit	0 - 1	1	-	-	-	0	0

*1 The default setting changes when the setting for o2-04 [Drive Model Selection] changes.

*2 Drive models 2211 to 2415 and 4103 to 4720 use these default settings when C6-01 = 1 [Normal / Heavy Duty Selection = Normal Duty Rating]. Drive models 2257 to 2415 and 4140 to 4720 use these default settings when C6-01 = 0 [Heavy Duty Rating].

- A1-02 = 2 [Open Loop Vector]: 2.00
- A1-02 = 3, 4 [Closed Loop Vector, Advanced Open Loop Vector]: 0.05

*3 The default setting changes when the setting of C6-01 [Normal / Heavy Duty Selection] changes.

*4 The setting range varies depending on the setting of E5-01 [PM Motor Code Selection] when A1-02 = 5 [Control Method Selection = PM Open Loop Vector].

*5 The default setting changes when the drive model and E1-03 [V/f Pattern Selection] change.

*6 This is the value for 200 V class drives. Double the value for 400 V class drives.

*7 The maximum value within the setting range is 100.0 when A1-02 = 5 or 7 [Control Method Selection = PM Open Loop Vector or PM Closed Loop Vector].

*8 The setting range is -100.0 to 100.0 when A1-02 = 5 or 7 [Control Method Selection = PM Open Loop Vector or PM Closed Loop Vector].

◆ A1-02 = 5 to 8 [Control Method for PM Motors and EZ Vector Control]

No.	Name	Range	Unit	Control Method (A1-02 Setting)			
				OLV/PM (5)	AOLV/PM (6)	CLV/PM (7)	EZOLV (8)
b2-01	DC Injection/Zero SpeedThreshold	0.0 - 10.0	0.1	0.5 Hz	1.0%	0.5%	0.5 Hz
b2-04	DC Inject Braking Time at Stop	0.00 - 10.00	0.01 s	0.00	0.00	0.00	0.00
b3-01	Speed Search at Start Selection	0 - 1	1	0	0	-	0
b3-02	SpeedSearch Deactivation Current	0 - 200	1%	-	-	-	-
b3-08	Speed Estimation ACR P Gain	0.00 - 6.00	0.01	0.30	0.30	-	0.60 *1
b3-09	Speed Estimation ACR I Time	0.0 - 1000.0	0.1 ms	2.0	4.0	-	10.0
b3-14	Bi-directional Speed Search	0 - 1	1	-	-	-	0
b5-15	PID Sleep Function Start Level	0.0 - 400.0 *3	0.1	0.0 Hz	0.0%	0.0%	0.0 Hz
b6-01	Dwell Reference at Start	0.0 - 400.0 *3	0.1	0.0 Hz	0.0%	0.0%	0.0 Hz

11.18 Parameters that Change from the Default Settings with A1-02 [Control Method Selection]

No.	Name	Range	Unit	Control Method (A1-02 Setting)			
				OLV/PM (5)	AOLV/PM (6)	CLV/PM (7)	EZOLV (8)
b6-03	Dwell Reference at Stop	0.0 - 400.0 *3	0.1	0.0 Hz	0.0%	0.0%	0.0 Hz
b8-02	Energy Saving Gain	0.0 - 10.0	0.1	-	-	-	-
b8-03	Energy Saving Filter Time	0.00 - 10.00	0.01 s	-	-	-	-
b8-19	E-Save Search Injection Freq	10 - 300	1 Hz	-	100	100	20
C1-11	Accel/Decel Time Switchover Freq	0.0 - 400.0 *3	0.1	0.0 Hz	0.0%	0.0%	0.0 Hz
C2-01	S-Curve Time @ Start of Accel	0.00 - 10.00	0.01 s	1.00	0.20	0.20	1.00
C3-01	Slip Compensation Gain	0.0 - 2.5	0.1	-	-	-	0.0
C3-02	Slip Compensation Delay Time	0 - 10000	1 ms	-	-	-	200
C4-01	Torque Compensation Gain	0.00 - 2.50	0.01	0.00	-	-	0.00
C4-02	Torque Compensation Delay Time	0 - 60000	1 ms	100	-	-	200
C5-01	ASR Proportional Gain 1	0.00 - 300.00	0.01	-	10.00	20.00	10.00
C5-02	ASR Integral Time 1	0.000 - 60.000	0.001 s	-	0.500	0.500	0.500
C5-03	ASR Proportional Gain 2	0.00 - 300.00	0.01	-	10.00	20.00	10.00
C5-04	ASR Integral Time 2	0.000 - 60.000	0.001 s	-	0.500	0.500	0.500
C5-06	ASR Delay Time	0.000 - 0.500	0.001 s	-	0.016	0.004	0.004
C5-07	ASR Gain Switchover Frequency	0.0 - 400.0 *3	0.1	-	0.0%	0.0%	0.0 Hz
C6-02	Carrier Frequency Selection	1 - F	1	2	2	2	2
d3-01	Jump Frequency 1	0.0 - 400.0 *3	0.1	0.0 Hz	0.0%	0.0%	0.0 Hz
d3-02	Jump Frequency 2	0.0 - 400.0 *3	0.1	0.0 Hz	0.0%	0.0%	0.0 Hz
d3-03	Jump Frequency 3	0.0 - 400.0 *3	0.1	0.0 Hz	0.0%	0.0%	0.0 Hz
d3-04	Jump Frequency Width	0.0 - 20.0 *4	0.1	1.0 Hz	1.0%	1.0%	1.0 Hz
d5-02	Torque Reference Delay Time	0 - 1000	1 ms	-	0	0	-
E1-04	Maximum Output Frequency	40.0 - 400.0 *5	0.1 Hz	Determined by E5-01	Determined by E5-01	Determined by E5-01	-
E1-05	Maximum Output Voltage	0.0 - 255.0 *6	0.1 V	Determined by E5-01	Determined by E5-01	Determined by E5-01	-
E1-06	Base Frequency	0.0 - 400.0	0.1 Hz	Determined by E5-01	Determined by E5-01	Determined by E5-01	-
E1-07	Mid Point A Frequency	0.0 - 400.0	0.1 Hz	-	-	-	-
E1-08	Mid Point A Voltage	0.0 - 255.0 *6	0.1 V	-	-	-	-
E1-09	Minimum Output Frequency	0.0 - 400.0	0.1 Hz	Determined by E5-01	Determined by E5-01	Determined by E5-01	-
E1-10	Minimum Output Voltage	0.0 - 255.0 *6	0.1 V	-	-	-	-
F1-01	Encoder 1 Pulse Count (PPR)	0 - 60000	1 ppr	-	-	1024	-
F1-05	Encoder 1 Rotation Selection	0 - 1	1	-	-	1	-
F1-09	Overspeed Detection Delay Time	0.0 - 2.0	0.1 s	-	0.0	0.0	0.0
L1-01	Motor Overload (oL1) Protection	0 - 6	1	4	4	5	1 *7

11.18 Parameters that Change from the Default Settings with A1-02 [Control Method Selection]

No.	Name	Range	Unit	Control Method (A1-02 Setting)			
				OLV/PM (5)	AOLV/PM (6)	CLV/PM (7)	EZOLV (8)
L2-31	KEB Start Voltage Offset Level	0 - 100 *6	1 V	50	50	50	50
L3-05	Stall Prevention during RUN	0 - 3	1	2	-	-	3
L3-20	DC Bus Voltage Adjustment Gain	0.00 - 5.00	0.01	0.65	0.65	0.65	0.65
L3-21	OVSUPPRESSION Accel/Decel P Gain	0.10 - 10.00	0.01	1.00	1.00	1.00	1.00
L3-36	Current Suppression Gain@Accel	0.0 - 100.0	0.1	-	-	-	-
L4-01	Speed Agree Detection Level	0.0 - 400.0 *3	0.1	0.0 Hz	0.0%	0.0%	0.0 Hz
L4-02	Speed Agree Detection Width	0.0 - 20.0 *4	0.1	2.0 Hz	4.0%	4.0%	2.0Hz
L4-03	Speed Agree Detection Level(+/-)	-400.0 - +400.0 *8	0.1	0.0 Hz	0.0%	0.0%	0.0 Hz
L4-04	Speed Agree Detection Width(+/-)	0.0 - 20.0 *4	0.1	2.0 Hz	4.0%	4.0%	2.0Hz
L8-38	Carrier Frequency Reduction	0 - 2	1	0	-	0	0
L8-40	Carrier Freq Reduction Off-Delay	0.00 - 2.00	0.01 s	0.00	-	0.00	0.00
L8-90	STPo Detection Level (Low Speed)	0 - 5000	1	0	80	-	0
n1-15	PWM Voltage Offset Calibration	0 - 2	1	1	1	1	1
n5-04	Speed Response Frequency	0.00 - 500.00	0.01 Hz	-	20.00	50.00	-
n8-35	Initial Pole Detection Method	0 - 2	1	0	1	1	-
n8-51	Pull-in Current @ Acceleration	0 - 200	1%	50%	-	-	80%
o1-03	Frequency Display Unit Selection	0 - 3	1	2	2	2	0 *9
o1-04	V/f Pattern Display Unit	0 - 1	1	-	1	1	0 *9

*1 The default setting is different for different models.

- 2138 - 2415, 4089 - 4720: 0.30

*2 The unit of measure changes when o2-04 changes.

*3 The setting range is 0.0 to 100.0 when A1-02 = 6 or 7 [PM Advanced Open Loop Vector or PM Closed Loop Vector].

*4 The setting range is 0.0 to 40.0 when A1-02 = 6 or 7 [PM Advanced Open Loop Vector or PM Closed Loop Vector].

*5 The default setting changes when the setting for C6-01 [Normal / Heavy Duty Selection] changes.

*6 This is the value for 200 V class drives. Double the value for 400 V class drives.

*7 The default settings are different for different motor types.

- E9-01 = 0 [Motor Type Selection = Induction (IM)]: 1
- E9-01 = 1, 2 [Permanent Magnet (PM), Synchronous Reluctance (SynRM)]: 4

*8 The setting range is -100.0 to +100.0 when A1-02 = 6 or 7 [PM Advanced Open Loop Vector or PM Closed Loop Vector].

*9 The default settings are different for different motor types.

- E9-01 = 0 [Motor Type Selection = Induction (IM)]: 0
- E9-01 = 1, 2 [Permanent Magnet (PM), Synchronous Reluctance (SynRM)]: 1

11.19 Parameters that Change from the Default Settings with E3-01 [Motor 2 Control Mode Selection]

The values for the parameters in these tables depend on the values for parameter *E3-01*. When you change the setting for *E3-01*, the default settings will change.

No.	Name	Range	Unit	Motor 2 Control Method (setting value of E3-01)			
				V/f (0)	CL-V/f (1)	OLV (2)	CLV (3)
C3-21	Motor 2 Slip Compensation Gain	0.0 - 2.50	0.1	0.0	-	1.0	1.0
C3-22	Motor 2 Slip Comp Delay Time	0 - 10000	1 ms	2000	-	200	-
C5-21	Motor 2 ASR Proportional Gain 1 (P)	0.00 - 300.00	0.01	-	0.20	-	20.00
C5-22	Motor 2 ASR Integral Time 1 (I)	0.000 - 10.000	0.001 s	-	0.200	-	0.500
C5-23	Motor 2 ASR Proportional Gain 2 (P)	0.00 - 300.00	0.01	-	0.02	-	20.00
C5-24	Motor 2 ASR Integral Time 2 (I)	0.000 - 10.000	0.001 s	-	0.050	-	0.500
C5-26	Motor 2 ASR Delay Time	0.000 - 0.500	0.001 s	-	-	-	0.004
E3-04	Motor 2 Maximum Output Frequency	40.0 - 590.0	0.1 Hz	60.0	60.0	60.0	60.0
E3-05	Motor 2 Maximum Output Voltage	0.0 - 255.0 */	0.1 V	200.0	200.0	200.0	200.0
E3-06	Motor 2 Base Frequency	0.0 - 590.0	0.1 Hz	60.0	60.0	60.0	60.0
E3-07	Motor 2 Mid Point A Frequency	0.0 - 590.0	0.1 Hz	3.0	3.0	3.0	-
E3-08	Motor 2 Mid Point A Voltage	0.0 - 255.0 */	0.1 V	15.0	15.0	11.0	-
E3-09	Motor 2 Minimum Output Frequency	0.0 - 590.0	0.1 Hz	1.5	1.5	0.5	0.0
E3-10	Motor 2 Minimum Output Voltage	0.0 - 255.0 */	0.1 V	9.0	9.0	2.0	-
E3-11	Motor 2 Mid Point B Frequency	0.0 - 590.0	Determined by o1-04	0.0	0.0	0.0	0.0
E3-12	Motor 2 Mid Point B Voltage	0.0 - 255.0 */	0.1 V	0.0	0.0	0.0	0.0
E3-13	Motor 2 Base Voltage	0.0 - 255.0 */	0.1 V	0.0	0.0	0.0	0.0

*1 This is the value for 200 V class drives. Double the value for 400 V class drives.

11.20 Parameters Changed by E1-03 [V/f Pattern Selection]

The values for parameters *A1-02 [Control Method Selection]* and *E1-03 [V/f Pattern Selection]* change the default settings for the parameters in these tables:

Table 11.1 Parameters Changed by E1-03: 2004 to 2021 (HD), 4002 to 4018 (ND), 4002 to 4012 (HD), and 4002 to 4009 (ND)

No.	Unit	Setting Value															Control Method (A1-02 Setting)					
		0	1	2	3	4	5	6	7	8	9	A	B	C	D	E	F	OLV (2)	CLV (3)	OLV/PM (5)	AOL V/PM (6)	CLV/PM (7)
E1-04	Hz	50.0	60.0	60.0	72.0	50.0	50.0	60.0	60.0	50.0	50.0	60.0	60.0	90.0	120.0	180.0	60.0 * <i>J</i>	60.0	60.0	*2	*2	*2
E1-05 * <i>3</i>	V	230.0	230.0	230.0	230.0	230.0	230.0	230.0	230.0	230.0	230.0	230.0	230.0	230.0	230.0	230.0	230.0 * <i>J</i>	230.0	230.0	*2	*2	*2
E1-06	Hz	50.0	60.0	50.0	60.0	50.0	50.0	60.0	60.0	50.0	50.0	60.0	60.0	60.0	60.0	60.0	60.0 * <i>J</i>	60.0	60.0	*2	*2	*2
E1-07	Hz	2.5	3.0	3.0	3.0	2.5	2.5	3.0	3.0	2.5	2.5	3.0	3.0	3.0	3.0	3.0	3.0 * <i>J</i>	3.0	0.0	-	-	-
E1-08 * <i>3</i>	V	17.3	17.3	17.3	17.3	40.3	57.5	40.3	57.5	21.9	27.6	21.9	27.6	17.3	17.3	17.3	17.3 * <i>J</i>	13.8	0.0	-	-	-
E1-09	Hz	1.3	1.5	1.5	1.5	1.3	1.3	1.5	1.5	1.3	1.3	1.5	1.5	1.5	1.5	1.5	1.5 * <i>J</i>	0.5	0.0	*2	*2	0.0
E1-10 * <i>3</i>	V	10.4	10.4	10.4	10.4	9.2	10.4	9.2	10.4	12.7	15.0	12.7	17.3	10.4	10.4	10.4	10.2 * <i>J</i>	2.9	0.0	-	-	-

*1 These values are the default settings for *E1-04 to E1-10* and *E3-04 to E3-10 [V/f Pattern for Motor 2]*. These settings are the same as those for the V/f pattern when *E1-03 = 1 [Const Trq, 60Hz base, 60Hz max]*.

*2 The default setting varies depending on the setting of *E5-01 [PM Motor Code Selection]*.

*3 This is the value for 200 V class drives. Double the value for 400 V class drives.

Table 11.2 Parameters Changed by E1-03: 2030 to 2211 (HD), 2021 to 2169 (ND), 4018 to 4103 (HD), and 4012 to 4089 (ND)

No.	Unit	Setting Value															Control Method (A1-02 Setting)					
		0	1	2	3	4	5	6	7	8	9	A	B	C	D	E	F	OLV (2)	CLV (3)	OLV/PM (5)	AOL V/PM (6)	CLV/PM (7)
E1-04	Hz	50.0	60.0	60.0	72.0	50.0	50.0	60.0	60.0	50.0	50.0	60.0	60.0	90.0	120.0	180.0	60.0 * <i>J</i>	60.0	60.0	*2	*2	*2
E1-05 * <i>3</i>	V	230.0	230.0	230.0	230.0	230.0	230.0	230.0	230.0	230.0	230.0	230.0	230.0	230.0	230.0	230.0	230.0 * <i>J</i>	230.0	230.0	*2	*2	*2
E1-06	Hz	50.0	60.0	50.0	60.0	50.0	50.0	60.0	60.0	50.0	50.0	60.0	60.0	60.0	60.0	60.0	60.0 * <i>J</i>	60.0	60.0	*2	*2	*2
E1-07	Hz	2.5	3.0	3.0	3.0	2.5	2.5	3.0	3.0	2.5	2.5	3.0	3.0	3.0	3.0	3.0	3.0 * <i>J</i>	3.0	0.0	-	-	-
E1-08 * <i>3</i>	V	16.1	16.1	16.1	16.1	40.3	57.5	40.3	57.5	20.7	26.5	20.7	26.5	16.1	16.1	16.1	16.1 * <i>J</i>	12.7	0.0	-	-	-
E1-09	Hz	1.3	1.5	1.5	1.5	1.3	1.3	1.5	1.5	1.3	1.3	1.5	1.5	1.5	1.5	1.5	1.5 * <i>J</i>	0.5	0.0	*2	*2	0.0
E1-10 * <i>3</i>	V	8.1	8.1	8.1	8.1	6.9	8.1	6.9	8.1	10.4	12.7	10.4	15.0	8.1	8.1	8.1	8.1 * <i>J</i>	2.3	0.0	-	-	-

*1 These values are the default settings for *E1-04 to E1-10* and *E3-04 to E3-10 [V/f Pattern for Motor 2]*. These settings are the same as those for the V/f pattern when *E1-03 = 1 [Const Trq, 60Hz base, 60Hz max]*.

*2 The default setting varies depending on the setting of *E5-01 [PM Motor Code Selection]*.

*3 This is the value for 200 V class drives. Double the value for 400 V class drives.

Table 11.3 Parameters Changed by E1-03: 2257 to 2415 (HD), 2211 to 2415 (ND), 4140 to 4720 (HD), and 4103 to 4720 (ND)

No.	Unit	Setting Value																Control Method (A1-02 Setting)				
		0	1	2	3	4	5	6	7	8	9	A	B	C	D	E	F	OLV (2)	CLV (3)	OLV/ PM (5)	AOL V/PM (6)	CLV/ PM (7)
E1-04	Hz	50.0	60.0	60.0	72.0	50.0	50.0	60.0	60.0	50.0	50.0	60.0	60.0	90.0	120.0	180.0	60.0 <i>*1</i>	60.0	60.0	<i>*2</i>	<i>*2</i>	<i>*2</i>
E1-05 <i>*3</i>	V	230.0	230.0	230.0	230.0	230.0	230.0	230.0	230.0	230.0	230.0	230.0	230.0	230.0	230.0	230.0	230.0 <i>*1</i>	230.0	230.0	<i>*2</i>	<i>*2</i>	<i>*2</i>
E1-06	Hz	50.0	60.0	50.0	60.0	50.0	50.0	60.0	60.0	50.0	50.0	60.0	60.0	60.0	60.0	60.0	60.0 <i>*1</i>	60.0	60.0	<i>*2</i>	<i>*2</i>	<i>*2</i>
E1-07	Hz	2.5	3.0	3.0	3.0	25.0	25.0	30.0	30.0	2.5	2.5	3.0	3.0	3.0	3.0	3.0	3.0 <i>*1</i>	3.0	0.0	-	-	-
E1-08 <i>*3</i>	V	13.8	13.8	13.8	13.8	40.3	57.5	40.3	57.5	17.3	23.0	17.3	23.0	13.8	13.8	13.8	13.8 <i>*1</i>	12.7	0.0	-	-	-
E1-09	Hz	1.3	1.5	1.5	1.5	1.3	1.3	1.5	1.5	1.3	1.3	1.5	1.5	1.5	1.5	1.5	1.5 <i>*1</i>	0.5	0.0	<i>*2</i>	<i>*2</i>	0.0
E1-10 <i>*3</i>	V	6.9	6.9	6.9	6.9	5.8	6.9	5.8	6.9	8.1	10.4	8.1	12.7	6.9	6.9	6.9	6.9 <i>*1</i>	2.3	0.0	-	-	-

*1 These values are the default settings for E1-04 to E1-10 and E3-04 to E3-10 [V/f Pattern for Motor 2]. These settings are the same as those for the V/f pattern when E1-03 = 1 [Const Trq, 60Hz base, 60Hz max].

*2 The default setting varies depending on the setting of E5-01 [PM Motor Code Selection].

*3 This is the value for 200 V class drives. Double the value for 400 V class drives.

11.21 Defaults by Drive Model and Duty Rating ND/HD

The values for the parameters in these tables depend on the values for parameters *o2-04* and *C6-01*. Changing the settings for *o2-04* and *C6-01* will change the default settings.

◆ 200 V class

No. */	Name	Unit	Default							
			2004		2006		2008		2010	
-	Drive Model	-	HD	ND	HD	ND	HD	ND	HD	ND
C6-01	Normal / Heavy Duty Selection	-	0	1	0	1	0	1	0	1
o2-04	Drive Model (KVA) Selection	Hex.	62		63		64		65	
E2-11 (E4-11, E5-02)	Motor Rated Power	HP (kW)	0.75 (0.55)	1 (0.75)	1 (0.75)	1.5 (1.1)	1.5 (1.1)	2 (1.5)	2 (1.5)	3 (2.2)
b3-04	V/f Gain during Speed Search	%	100	100	100	100	100	100	100	100
b3-06	Speed Estimation Current Level 1	-	1	1	0.5	0.5	0.5	0.5	0.5	0.5
b3-08	Speed Estimation ACR P Gain	-	0.5	0.5	0.5	0.5	0.5	0.5	0.5	0.5
b3-26	Direction Determination Level	-	1000	1000	1000	1000	1000	1000	1000	1000
b8-03	Energy Saving Filter Time	s	0.50	0.50	0.50	0.50	0.50	0.50	0.50	0.50
b8-04	Energy Saving Coefficient Value	-	288.2	223.7	223.7	196.6	196.6	169.4	169.4	156.8
C5-17 (C5-37)	Motor Inertia	kgm ²	0.0015	0.0028	0.0028	0.0068	0.0068	0.0068	0.0068	0.0088
C6-02	Carrier Frequency Selection	-	1	7	1	7	1	7	1	7
E2-01 (E4-01)	Motor Rated Current (FLA)	A	1.9	3.3	3.3	4.9	4.9	6.2	6.2	8.5
E2-02 (E4-02)	Motor Rated Slip	Hz	2.9	2.5	2.5	2.6	2.6	2.6	2.6	2.9
E2-03 (E4-03)	Motor No-Load Current	A	1.2	1.8	1.8	2.3	2.3	2.8	2.8	3
E2-05 (E4-05)	Motor Line-to-Line Resistance	Ω	9.842	5.156	5.156	3.577	3.577	1.997	1.997	1.601
E2-06 (E4-06)	Motor Leakage Inductance	%	18.2	13.8	13.8	18.5	18.5	18.5	18.5	18.4
E2-10 (E4-10)	Motor Iron Loss	W	14	26	26	38	38	53	53	77
E5-01	PM Motor Code Selection	-	FFFF	FFFF	FFFF	FFFF	FFFF	FFFF	FFFF	FFFF
L2-02	Power Loss Ride Through Time	s	0.1	0.1	0.2	0.2	0.3	0.3	0.3	0.3
L2-03	Minimum Baseblock Time	s	0.2	0.3	0.3	0.4	0.4	0.4	0.4	0.5

No. */	Name	Unit	Default							
			2004		2006		2008		2010	
-	Drive Model	-	HD	ND	HD	ND	HD	ND	HD	ND
C6-01	Normal / Heavy Duty Selection	-	0	1	0	1	0	1	0	1
o2-04	Drive Model (KVA) Selection	Hex.	62		63		64		65	
E2-11 (E4-11, E5-02)	Motor Rated Power	HP (kW)	0.75 (0.55)	1 (0.75)	1 (0.75)	1.5 (1.1)	1.5 (1.1)	2 (1.5)	2 (1.5)	3 (2.2)
L2-04	Powerloss V/f Recovery Ramp Time	s	0.3	0.3	0.3	0.3	0.3	0.3	0.3	0.3
L2-05	Undervoltage Detection Lvl (Uv1)	-	190	190	190	190	190	190	190	190
L3-24	Motor Accel Time for Inertia Cal	s	0.178	0.142	0.142	0.142	0.142	0.166	0.166	0.145
L8-02	Overheat Alarm Level	°C	115	115	115	115	115	115	115	115
L8-09	Output Ground Fault Detection	-	1	1	1	1	1	1	1	1
L8-38	Carrier Frequency Reduction	-	2	2	2	2	2	2	2	2
n1-01	Hunting Prevention Selection	-	1	1	1	1	1	1	1	1
n1-03	Hunting Prevention Time Constant	ms	10	10	10	10	10	10	10	10
n5-02	Motor Inertia Acceleration Time	s	0.178	0.142	0.142	0.142	0.142	0.166	0.166	0.145

*1 Parameters within parentheses are for motor 2.

No. */	Name	Unit	Default							
			2012		2018		2021		2030	
-	Drive Model	-	HD	ND	HD	ND	HD	ND	HD	ND
C6-01	Normal / Heavy Duty Selection	-	0	1	0	1	0	1	0	1
o2-04	Drive Model (KVA) Selection	Hex.	66		67		68		6A	
E2-11 (E4-11, E5-02)	Motor Rated Power	HP (kW)	3 (2.2)	4 (3.0)	4 (3.0)	5 (3.7)	5 (3.7)	7.5 (5.5)	7.5 (5.5)	10 (7.5)
b3-04	V/f Gain during Speed Search	%	100	100	100	100	100	100	100	100
b3-06	Speed Estimation Current Level 1	-	0.5	0.5	0.5	0.5	0.5	0.5	0.5	0.5
b3-08	Speed Estimation ACR P Gain	-	0.5	0.5	0.5	0.5	0.5	0.5	0.5	0.5
b3-26	Direction Determination Level	-	1000	1000	1000	1000	1000	1000	1000	1000
b8-03	Energy Saving Filter Time	s	0.50	0.50	0.50	0.50	0.50	0.50	0.50	0.50
b8-04	Energy Saving Coefficient Value	-	156.8	136.4	136.4	122.9	122.9	94.75	94.75	72.69

11.21 Defaults by Drive Model and Duty Rating ND/HD

No. */	Name	Unit	Default							
			2012		2018		2021		2030	
-	Drive Model	-	HD	ND	HD	ND	HD	ND	HD	ND
C6-01	Normal / Heavy Duty Selection	-	0	1	0	1	0	1	0	1
o2-04	Drive Model (KVA) Selection	Hex.	66		67		68		6A	
E2-11 (E4-11, E5-02)	Motor Rated Power	HP (kW)	3 (2.2)	4 (3.0)	4 (3.0)	5 (3.7)	5 (3.7)	7.5 (5.5)	7.5 (5.5)	10 (7.5)
C5-17 (C5-37)	Motor Inertia	kgm ²	0.0088	0.0158	0.0158	0.0158	0.0158	0.0255	0.026	0.037
C6-02	Carrier Frequency Selection	-	1	7	1	7	1	7	1	7
E2-01 (E4-01)	Motor Rated Current (FLA)	A	8.5	11.4	11.4	14	14	19.6	19.6	26.6
E2-02 (E4-02)	Motor Rated Slip	Hz	2.9	2.7	2.7	2.73	2.73	1.5	1.5	1.3
E2-03 (E4-03)	Motor No-Load Current	A	3	3.7	3.7	4.5	4.5	5.1	5.1	8
E2-05 (E4-05)	Motor Line-to-Line Resistance	Ω	1.601	1.034	1.034	0.771	0.771	0.399	0.399	0.288
E2-06 (E4-06)	Motor Leakage Inductance	%	18.4	19	19	19.6	19.6	18.2	18.2	15.5
E2-10 (E4-10)	Motor Iron Loss	W	77	91	91	112	112	172	172	262
E5-01	PM Motor Code Selection	-	FFFF	FFFF	FFFF	FFFF	FFFF	FFFF	FFFF	FFFF
L2-02	Power Loss Ride Through Time	s	0.5	0.5	1	1	1	1	1	1
L2-03	Minimum Baseblock Time	s	0.5	0.5	0.5	0.6	0.6	0.7	0.7	0.8
L2-04	Powerloss V/f Recovery Ramp Time	s	0.3	0.3	0.3	0.3	0.3	0.3	0.3	0.3
L2-05	Undervoltage Detection Lvl (Uv1)	-	190	190	190	190	190	190	190	190
L3-24	Motor Accel Time for Inertia Cal	s	0.145	0.145	0.145	0.154	0.154	0.168	0.168	0.175
L8-02	Overheat Alarm Level	°C	124	124	110	110	110	110	110	110
L8-09	Output Ground Fault Detection	-	1	1	1	1	1	1	1	1
L8-38	Carrier Frequency Reduction	-	2	2	2	2	2	2	2	2
n1-01	Hunting Prevention Selection	-	1	1	1	1	1	1	1	1
n1-03	Hunting Prevention Time Constant	ms	10	10	10	10	10	10	10	10
n5-02	Motor Inertia Acceleration Time	s	0.145	0.145	0.145	0.154	0.154	0.168	0.168	0.175

*1 Parameters within parentheses are for motor 2.

11.21 Defaults by Drive Model and Duty Rating ND/HD

No.	Name	Unit	Default							
			2042		2056		2070		2082	
-	Drive Model	-	HD	ND	HD	ND	HD	ND	HD	ND
C6-01	Normal / Heavy Duty Selection	-	0	1	0	1	0	1	0	1
o2-04	Drive Model (KVA) Selection	Hex.	6B		6D		6E		6F	
E2-11 (E4-11, E5-02)	Motor Rated Power	HP (kW)	10 (7.5)	15 (11)	15 (11)	20 (15)	20 (15)	25 (18.5)	25 (18.5)	30 (22)
b3-04	V/f Gain during Speed Search	%	100	100	100	100	100	100	100	100
b3-06	Speed Estimation Current Level 1	-	0.5	0.5	0.5	0.5	0.5	0.5	0.5	0.5
b3-08	Speed Estimation ACR P Gain	-	0.5	0.5	0.5	0.5	0.5	0.5	0.5	0.5
b3-26	Direction Determination Level	-	1000	1000	1000	1000	1000	1000	1000	1000
b8-03	Energy Saving Filter Time	s	0.50	0.50	0.50	0.50	0.50	0.50	0.50	0.50
b8-04	Energy Saving Coefficient Value	-	72.69	70.44	70.44	63.13	63.13	57.87	57.87	51.79
C5-17 (C5-37)	Motor Inertia	kgm ²	0.037	0.053	0.053	0.076	0.076	0.138	0.138	0.165
C6-02	Carrier Frequency Selection	-	1	7	1	7	1	7	1	7
E2-01 (E4-01)	Motor Rated Current (FLA)	A	26.6	39.7	39.7	53	53	65.8	65.8	77.2
E2-02 (E4-02)	Motor Rated Slip	Hz	1.3	1.7	1.7	1.6	1.6	1.67	1.67	1.7
E2-03 (E4-03)	Motor No-Load Current	A	8	11.2	11.2	15.2	15.2	15.7	15.7	18.5
E2-05 (E4-05)	Motor Line-to-Line Resistance	Ω	0.288	0.23	0.23	0.138	0.138	0.101	0.101	0.079
E2-06 (E4-06)	Motor Leakage Inductance	%	15.5	19.5	19.5	17.2	17.2	15.7	20.1	19.5
E2-10 (E4-10)	Motor Iron Loss	W	262	245	245	272	272	505	505	538
E5-01	PM Motor Code Selection	-	FFFF	FFFF	FFFF	FFFF	FFFF	FFFF	FFFF	FFFF
L2-02	Power Loss Ride Through Time	s	1	1	2	2	2	2	2	2
L2-03	Minimum Baseblock Time	s	0.8	0.9	0.9	1	1	1	1	1
L2-04	Powerloss V/f Recovery Ramp Time	s	0.3	0.3	0.3	0.6	0.6	0.6	0.6	0.6
L2-05	Undervoltage Detection Lvl (Uv1)	-	190	190	190	190	190	190	190	190
L3-24	Motor Accel Time for Inertia Cal	s	0.175	0.265	0.265	0.244	0.244	0.317	0.317	0.355
L8-02	Overheat Alarm Level	°C	110	110	115	115	120	120	133	130

11.21 Defaults by Drive Model and Duty Rating ND/HD

No.	Name	Unit	Default							
			2042		2056		2070		2082	
-	Drive Model	-								
C6-01	Normal / Heavy Duty Selection	-	HD	ND	HD	ND	HD	ND	HD	ND
			0	1	0	1	0	1	0	1
o2-04	Drive Model (KVA) Selection	Hex.	6B		6D		6E		6F	
E2-11 (E4-11, E5-02)	Motor Rated Power	HP (kW)	10 (7.5)	15 (11)	15 (11)	20 (15)	20 (15)	25 (18.5)	25 (18.5)	30 (22)
L8-09	Output Ground Fault Detection	-	1	1	1	1	1	1	1	1
L8-38	Carrier Frequency Reduction	-	2	2	2	2	2	2	2	2
n1-01	Hunting Prevention Selection	-	1	1	2	2	2	2	2	2
n1-03	Hunting Prevention Time Constant	ms	10	10	10	10	10	10	10	10
n5-02	Motor Inertia Acceleration Time	s	0.175	0.265	0.265	0.244	0.244	0.317	0.317	0.355

*1 Parameters within parentheses are for motor 2.

No. */	Name	Unit	Default							
			2110		2138		2169		2211	
-	Drive Model	-								
C6-01	Normal / Heavy Duty Selection	-	HD	ND	HD	ND	HD	ND	HD	ND
			0	1	0	1	0	1	0	1
o2-04	Drive Model (KVA) Selection	Hex.	70		72		73		74	
E2-11 (E4-11, E5-02)	Motor Rated Power	HP (kW)	30 (22)	40 (30)	40 (30)	50 (37)	50 (37)	60 (45)	60 (45)	75 (55)
b3-04	V/f Gain during Speed Search	%	100	80	80	80	80	80	80	80
b3-06	Speed Estimation Current Level 1	-	0.5	0.5	0.5	0.5	0.5	0.5	0.5	0.5
b3-08	Speed Estimation ACR P Gain	-	0.5	0.5	0.5	0.5	0.5	0.5	0.5	0.5
b3-26	Direction Determination Level	-	1000	1000	1000	1000	1000	1000	1000	1000
b8-03	Energy Saving Filter Time	s	0.50	0.50	0.50	0.50	0.50	0.50	0.50	2.00
b8-04	Energy Saving Coefficient Value	-	51.79	46.27	46.27	38.16	38.16	35.78	35.78	31.35
C5-17 (C5-37)	Motor Inertia	kgm ²	0.165	0.220	0.220	0.273	0.273	0.333	0.333	0.490
C6-02	Carrier Frequency Selection	-	1	7	1	7	1	7	1	7
E2-01 (E4-01)	Motor Rated Current (FLA)	A	77.2	105	105	131	131	160	160	190
E2-02 (E4-02)	Motor Rated Slip	Hz	1.7	1.8	1.8	1.33	1.33	1.6	1.6	1.43

No. */	Name	Unit	Default							
			2110		2138		2169		2211	
-	Drive Model	-	HD	ND	HD	ND	HD	ND	HD	ND
C6-01	Normal / Heavy Duty Selection	-	0	1	0	1	0	1	0	1
o2-04	Drive Model (KVA) Selection	Hex.	70		72		73		74	
E2-11 (E4-11, E5-02)	Motor Rated Power	HP (kW)	30 (22)	40 (30)	40 (30)	50 (37)	50 (37)	60 (45)	60 (45)	75 (55)
E2-03 (E4-03)	Motor No-Load Current	A	18.5	21.9	21.9	38.2	38.2	44	44	45.6
E2-05 (E4-05)	Motor Line-to-Line Resistance	Ω	0.079	0.064	0.064	0.039	0.039	0.03	0.03	0.022
E2-06 (E4-06)	Motor Leakage Inductance	%	19.5	20.8	20.8	18.8	18.8	20.2	20.2	20.5
E2-10 (E4-10)	Motor Iron Loss	W	538	699	699	823	823	852	852	960
E5-01	PM Motor Code Selection	-	FFFF	FFFF	FFFF	FFFF	FFFF	FFFF	FFFF	FFFF
L2-02	Power Loss Ride Through Time	s	2	2	2	2	2	2	2	2
L2-03	Minimum Baseblock Time	s	1	1.1	1.1	1.1	1.1	1.2	1.2	1.3
L2-04	Powerloss V/f Recovery Ramp Time	s	0.6	0.6	0.6	0.6	0.6	1	1	1
L2-05	Undervoltage Detection Lvl (Uv1)	-	190	190	190	190	190	190	190	190
L3-24	Motor Accel Time for Inertia Cal	s	0.355	0.323	0.323	0.32	0.32	0.387	0.387	0.317
L8-02	Overheat Alarm Level	°C	105	105	115	115	105	105	105	105
L8-09	Output Ground Fault Detection	-	1	1	1	1	1	1	1	1
L8-38	Carrier Frequency Reduction	-	2	2	2	2	2	2	2	2
n1-01	Hunting Prevention Selection	-	2	2	2	2	2	2	2	2
n1-03	Hunting Prevention Time Constant	ms	10	10	10	10	10	10	10	10
n5-02	Motor Inertia Acceleration Time	s	0.355	0.323	0.323	0.32	0.32	0.387	0.387	0.317

*1 Parameters within parentheses are for motor 2.

11.21 Defaults by Drive Model and Duty Rating ND/HD

No.	Name	Unit	Default							
			2257		2313		2360		2415	
-	Drive Model	-	HD	ND	HD	ND	HD	ND	HD	ND
C6-01	Normal / Heavy Duty Selection	-	0	1	0	1	0	1	0	1
o2-04	Drive Model (KVA) Selection	Hex.	75		76		77		78	
E2-11 (E4-11, E5-02)	Motor Rated Power	HP (kW)	75 (55)	100 (75)	100 (75)	125 (90)	125 (90)	150 (110)	150 (110)	150 (110)
b3-04	V/f Gain during Speed Search	%	80	80	80	80	80	80	80	80
b3-06	Speed Estimation Current Level 1	-	0.5	0.7	0.7	0.7	0.7	0.7	0.7	0.7
b3-08	Speed Estimation ACR P Gain	-	0.5	0.5	0.5	0.5	0.5	0.5	0.5	0.5
b3-26	Direction Determination Level	-	1000	1000	1000	1000	1000	1000	1000	1000
b8-03	Energy Saving Filter Time	s	2.00	2.00	2.00	2.00	2.00	2.00	2.00	2.00
b8-04	Energy Saving Coefficient Value	-	31.35	23.1	23.1	20.65	20.65	18.12	18.12	18.12
C5-17 (C5-37)	Motor Inertia	kgm ²	0.49	0.90	0.90	1.10	1.10	1.90	1.90	1.90
C6-02	Carrier Frequency Selection	-	1	7	1	7	1	7	1	7
E2-01 (E4-01)	Motor Rated Current (FLA)	A	190	260	260	260	260	260	260	260
E2-02 (E4-02)	Motor Rated Slip	Hz	1.43	1.39	1.39	1.39	1.39	1.39	1.39	1.39
E2-03 (E4-03)	Motor No-Load Current	A	45.6	72	72	72	72	72	72	72
E2-05 (E4-05)	Motor Line-to-Line Resistance	Ω	0.022	0.023	0.023	0.023	0.023	0.023	0.023	0.023
E2-06 (E4-06)	Motor Leakage Inductance	%	20.5	20	20	20	20	20	20	20
E2-10 (E4-10)	Motor Iron Loss	W	960	1200	1200	1200	1200	1200	1200	1200
E5-01	PM Motor Code Selection	-	FFFF	FFFF	FFFF	FFFF	FFFF	FFFF	FFFF	FFFF
L2-02	Power Loss Ride Through Time	s	2	2	2	2	2	2	2	2
L2-03	Minimum Baseblock Time	s	1.3	1.5	1.5	1.5	1.5	1.7	1.7	1.7
L2-04	Powerloss V/f Recovery Ramp Time	s	1	1	1	1	1	1	1	1
L2-05	Undervoltage Detection Lvl (Uv1)	-	190	190	190	190	190	190	190	190
L3-24	Motor Accel Time for Inertia Cal	s	0.317	0.533	0.533	0.592	0.592	0.646	0.646	0.646
L8-02	Overheat Alarm Level	°C	105	105	105	105	105	105	105	105

No.	Name	Unit	Default							
			2257		2313		2360		2415	
-	Drive Model	-								
C6-01	Normal / Heavy Duty Selection	-	HD	ND	HD	ND	HD	ND	HD	ND
			0	1	0	1	0	1	0	1
o2-04	Drive Model (KVA) Selection	Hex.	75		76		77		78	
E2-11 (E4-11, E5-02)	Motor Rated Power	HP (kW)	75 (55)	100 (75)	100 (75)	125 (90)	125 (90)	150 (110)	150 (110)	150 (110)
L8-09	Output Ground Fault Detection	-	1	1	1	1	1	1	1	1
L8-38	Carrier Frequency Reduction	-	2	2	2	2	2	2	2	2
n1-01	Hunting Prevention Selection	-	2	2	2	2	2	2	2	2
n1-03	Hunting Prevention Time Constant	ms	10	10	10	10	100	100	100	100
n5-02	Motor Inertia Acceleration Time	s	0.317	0.533	0.533	0.592	0.592	0.646	0.646	0.646

*1 Parameters within parentheses are for motor 2.

◆ 400 V Class

No. */	Name	Unit	Default							
			4002		4004		4005		4007	
-	Drive Model	-								
C6-01	Normal / Heavy Duty Selection	-	HD	ND	HD	ND	HD	ND	HD	ND
			0	1	0	1	0	1	0	1
o2-04	Drive Model (KVA) Selection	Hex.	92		93		94		95	
E2-11 (E4-11, E5-02)	Motor Rated Power	HP (kW)	0.75 (0.4)	1 (0.75)	1 (1.1)	2 (1.5)	2 (1.5)	3 (2.2)	3 (2.2)	4 (3.0)
b3-04	V/f Gain during Speed Search	%	100	100	100	100	100	100	100	100
b3-06	Speed Estimation Current Level 1	-	0.5	0.5	0.5	0.5	0.5	0.5	0.5	0.5
b3-08	Speed Estimation ACR P Gain	-	0.5	0.5	0.5	0.5	0.5	0.5	0.5	0.5
b3-26	Direction Determination Level	-	1000	1000	1000	1000	1000	1000	1000	1000
b8-03	Energy Saving Filter Time	s	0.50	0.50	0.50	0.50	0.50	0.50	0.50	0.50
b8-04	Energy Saving Coefficient Value	-	576.4	447.4	447.4	338.8	338.8	313.6	313.6	265.7
C5-17 (C5-37)	Motor Inertia	kgm ²	0.0015	0.0028	0.0028	0.0068	0.0068	0.0088	0.0088	0.0158
C6-02	Carrier Frequency Selection	-	1	7	1	7	1	7	1	7
E2-01 (E4-01)	Motor Rated Current (FLA)	A	1	1.6	1.6	3.1	3.1	4.2	4.2	5.7

11.21 Defaults by Drive Model and Duty Rating ND/HD

No. */	Name	Unit	Default							
			4002		4004		4005		4007	
-	Drive Model	-	HD	ND	HD	ND	HD	ND	HD	ND
C6-01	Normal / Heavy Duty Selection	-	0	1	0	1	0	1	0	1
o2-04	Drive Model (KVA) Selection	Hex.	92		93		94		95	
E2-11 (E4-11, E5-02)	Motor Rated Power	HP (kW)	0.75 (0.4)	1 (0.75)	1 (1.1)	2 (1.5)	2 (1.5)	3 (2.2)	3 (2.2)	4 (3.0)
E2-02 (E4-02)	Motor Rated Slip	Hz	2.9	2.6	2.6	2.5	2.5	3	3	2.7
E2-03 (E4-03)	Motor No-Load Current	A	0.6	0.8	0.8	1.4	1.4	1.5	1.5	1.9
E2-05 (E4-05)	Motor Line-to-Line Resistance	Ω	38.198	22.459	22.459	10.1	10.1	6.495	6.495	4.360
E2-06 (E4-06)	Motor Leakage Inductance	%	18.2	14.3	14.3	18.3	18.3	18.7	18.7	19
E2-10 (E4-10)	Motor Iron Loss	W	14	26	26	53	53	77	77	105
E5-01	PM Motor Code Selection	-	FFFF	FFFF	FFFF	FFFF	FFFF	FFFF	FFFF	FFFF
L2-02	Power Loss Ride Through Time	s	0.1	0.1	0.2	0.2	0.3	0.3	0.5	0.5
L2-03	Minimum Baseblock Time	s	0.2	0.3	0.3	0.4	0.4	0.5	0.5	0.5
L2-04	Powerloss V/f Recovery Ramp Time	s	0.3	0.3	0.3	0.3	0.3	0.3	0.3	0.3
L2-05	Undervoltage Detection Lvl (Uvl)	-	380	380	380	380	380	380	380	380
L3-24	Motor Accel Time for Inertia Cal	s	0.178	0.142	0.142	0.166	0.166	0.145	0.145	0.145
L8-02	Overheat Alarm Level	°C	100	100	105	105	112	112	100	100
L8-09	Output Ground Fault Detection	-	1	1	1	1	1	1	1	1
L8-38	Carrier Frequency Reduction	-	2	2	2	2	2	2	2	2
n1-01	Hunting Prevention Selection	-	1	1	1	1	1	1	1	1
n1-03	Hunting Prevention Time Constant	ms	10	10	10	10	10	10	10	10
n5-02	Motor Inertia Acceleration Time	s	0.178	0.142	0.142	0.166	0.166	0.145	0.145	0.145

*1 Parameters within parentheses are for motor 2.

No. */	Name	Unit	Default							
			4009		4012		4018		4023	
-	Drive Model	-	HD	ND	HD	ND	HD	ND	HD	ND
C6-01	Normal / Heavy Duty Selection	-	0	1	0	1	0	1	0	1
o2-04	Drive Model (KVA) Selection	Hex.	96		97		99		9A	
E2-11 (E4-11, E5-02)	Motor Rated Power	HP (kW)	4 (3.0)	5 (4.0)	5 (4.0)	7.5 (5.5)	7.5 (5.5)	10 (7.5)	10 (7.5)	15 (11)
b3-04	V/f Gain during Speed Search	%	100	100	100	100	100	100	100	100
b3-06	Speed Estimation Current Level 1	-	0.5	0.5	0.5	0.5	0.5	0.5	0.5	0.5
b3-08	Speed Estimation ACR P Gain	-	0.5	0.5	0.5	0.5	0.5	0.5	0.5	0.5
b3-26	Direction Determination Level	-	1000	1000	1000	1000	1000	1000	1000	1000
b8-03	Energy Saving Filter Time	s	0.50	0.50	0.50	0.50	0.50	0.50	0.50	0.50
b8-04	Energy Saving Coefficient Value	-	265.7	245.8	245.8	189.5	189.5	145.38	145.38	140.88
C5-17 (C5-37)	Motor Inertia	kgm ²	0.0158	0.0158	0.0158	0.0255	0.026	0.037	0.037	0.053
C6-02	Carrier Frequency Selection	-	1	7	1	7	1	7	1	7
E2-01 (E4-01)	Motor Rated Current (FLA)	A	5.7	7	7	9.8	9.8	13.3	13.3	19.9
E2-02 (E4-02)	Motor Rated Slip	Hz	2.7	2.7	2.7	1.5	1.5	1.3	1.3	1.7
E2-03 (E4-03)	Motor No-Load Current	A	1.9	2.3	2.3	2.6	2.6	4	4	5.6
E2-05 (E4-05)	Motor Line-to-Line Resistance	Ω	4.360	3.333	3.333	1.595	1.595	1.152	1.152	0.922
E2-06 (E4-06)	Motor Leakage Inductance	%	19	19.3	19.3	18.2	18.2	15.5	15.5	19.6
E2-10 (E4-10)	Motor Iron Loss	W	105	130	130	193	193	263	263	385
E5-01	PM Motor Code Selection	-	FFFF	FFFF	FFFF	FFFF	FFFF	FFFF	FFFF	FFFF
L2-02	Power Loss Ride Through Time	s	0.5	0.5	0.5	0.5	0.8	0.8	1	1
L2-03	Minimum Baseblock Time	s	0.5	0.6	0.6	0.7	0.7	0.8	0.8	0.9
L2-04	Powerloss V/f Recovery Ramp Time	s	0.3	0.3	0.3	0.3	0.3	0.3	0.3	0.3
L2-05	Undervoltage Detection Lvl (Uv1)	-	380	380	380	380	380	380	380	380
L3-24	Motor Accel Time for Inertia Cal	s	0.145	0.154	0.154	0.168	0.168	0.175	0.175	0.265
L8-02	Overheat Alarm Level	°C	100	100	100	100	105	105	105	105

11.21 Defaults by Drive Model and Duty Rating ND/HD

No. *	Name	Unit	Default							
			4009		4012		4018		4023	
-	Drive Model	-	HD	ND	HD	ND	HD	ND	HD	ND
C6-01	Normal / Heavy Duty Selection	-	0	1	0	1	0	1	0	1
o2-04	Drive Model (KVA) Selection	Hex.	96		97		99		9A	
E2-11 (E4-11, E5-02)	Motor Rated Power	HP (kW)	4 (3.0)	5 (4.0)	5 (4.0)	7.5 (5.5)	7.5 (5.5)	10 (7.5)	10 (7.5)	15 (11)
L8-09	Output Ground Fault Detection	-	1	1	1	1	1	1	1	1
L8-38	Carrier Frequency Reduction	-	2	2	2	2	2	2	2	2
n1-01	Hunting Prevention Selection	-	1	1	1	1	1	1	1	1
n1-03	Hunting Prevention Time Constant	ms	10	10	10	10	10	10	10	10
n5-02	Motor Inertia Acceleration Time	s	0.145	0.154	0.154	0.168	0.168	0.175	0.175	0.265

*1 Parameters within parentheses are for motor 2.

No.	Name	Unit	Default							
			4031		4038		4044		4060	
-	Drive Model	-	HD	ND	HD	ND	HD	ND	HD	ND
C6-01	Normal / Heavy Duty Selection	-	0	1	0	1	0	1	0	1
o2-04	Drive Model (KVA) Selection	Hex.	9C		9D		9E		9F	
E2-11 (E4-11, E5-02)	Motor Rated Power	HP (kW)	15 (11)	20 (15)	20 (15)	25 (18.5)	25 (18.5)	30 (22)	30 (22)	40 (30)
b3-04	V/f Gain during Speed Search	%	100	100	100	100	100	100	100	100
b3-06	Speed Estimation Current Level 1	-	0.5	0.5	0.5	0.5	0.5	0.5	0.5	0.5
b3-08	Speed Estimation ACR P Gain	-	0.5	0.5	0.5	0.5	0.5	0.5	0.5	0.5
b3-26	Direction Determination Level	-	1000	1000	1000	1000	1000	1000	1000	1000
b8-03	Energy Saving Filter Time	s	0.50	0.50	0.50	0.50	0.50	0.50	0.50	0.50
b8-04	Energy Saving Coefficient Value	-	140.88	126.26	126.26	115.74	115.74	103.58	103.58	92.54
C5-17 (C5-37)	Motor Inertia	kgm ²	0.053	0.076	0.076	0.138	0.138	0.165	0.165	0.220
C6-02	Carrier Frequency Selection	-	1	7	1	7	1	7	1	7
E2-01 (E4-01)	Motor Rated Current (FLA)	A	19.9	26.5	26.5	32.9	32.9	38.6	38.6	52.3
E2-02 (E4-02)	Motor Rated Slip	Hz	1.7	1.6	1.6	1.67	1.67	1.7	1.7	1.8

No.	Name	Unit	Default							
			4031		4038		4044		4060	
-	Drive Model	-	HD	ND	HD	ND	HD	ND	HD	ND
C6-01	Normal / Heavy Duty Selection	-	0	1	0	1	0	1	0	1
o2-04	Drive Model (KVA) Selection	Hex.	9C		9D		9E		9F	
E2-11 (E4-11, E5-02)	Motor Rated Power	HP (kW)	15 (11)	20 (15)	20 (15)	25 (18.5)	25 (18.5)	30 (22)	30 (22)	40 (30)
E2-03 (E4-03)	Motor No-Load Current	A	5.6	7.6	7.6	7.8	7.8	9.2	9.2	10.9
E2-05 (E4-05)	Motor Line-to-Line Resistance	Ω	0.922	0.55	0.55	0.403	0.403	0.316	0.316	0.269
E2-06 (E4-06)	Motor Leakage Inductance	%	19.6	17.2	17.2	20.1	20.1	23.5	23.5	20.7
E2-10 (E4-10)	Motor Iron Loss	W	385	440	440	508	508	586	586	750
E5-01	PM Motor Code Selection	-	FFFF	FFFF	FFFF	FFFF	FFFF	FFFF	FFFF	FFFF
L2-02	Power Loss Ride Through Time	s	2	2	2	2	2	2	2	2
L2-03	Minimum Baseblock Time	s	0.9	1	1	1	1	1	1	1.1
L2-04	Powerloss V/f Recovery Ramp Time	s	0.3	0.6	0.6	0.6	0.6	0.6	0.6	0.6
L2-05	Undervoltage Detection Lvl (Uv1)	-	380	380	380	380	380	380	380	380
L3-24	Motor Accel Time for Inertia Cal	s	0.265	0.244	0.244	0.317	0.317	0.355	0.355	0.323
L8-02	Overheat Alarm Level	°C	115	115	120	120	120	120	130	137
L8-09	Output Ground Fault Detection	-	1	1	1	1	1	1	1	1
L8-38	Carrier Frequency Reduction	-	2	2	2	2	2	2	2	2
n1-01	Hunting Prevention Selection	-	2	2	2	2	2	2	2	2
n1-03	Hunting Prevention Time Constant	ms	10	10	10	10	10	10	10	10
n5-02	Motor Inertia Acceleration Time	s	0.265	0.244	0.244	0.317	0.317	0.355	0.355	0.323

*1 Parameters within parentheses are for motor 2.

11.21 Defaults by Drive Model and Duty Rating ND/HD

No.	Name	Unit	Default							
			4075		4089		4103		4140	
-	Drive Model	-	HD	ND	HD	ND	HD	ND	HD	ND
C6-01	Normal / Heavy Duty Selection	-	0	1	0	1	0	1	0	1
o2-04	Drive Model (KVA) Selection	Hex.	A1		A2		A3		A4	
E2-11 (E4-11, E5-02)	Motor Rated Power	HP (kW)	40 (30)	50 (37)	50 (37)	60 (45)	60 (45)	75 (55)	75 (55)	100 (75)
b3-04	V/f Gain during Speed Search	%	100	100	100	100	100	80	80	60
b3-06	Speed Estimation Current Level 1	-	0.5	0.5	0.5	0.5	0.5	0.5	0.5	0.7
b3-08	Speed Estimation ACR P Gain	-	0.5	0.5	0.5	0.5	0.5	0.5	0.5	0.8
b3-26	Direction Determination Level	-	1000	1000	1000	1000	1000	1000	1000	1000
b8-03	Energy Saving Filter Time	s	0.50	0.50	0.50	0.50	0.50	2.00	2.00	2.00
b8-04	Energy Saving Coefficient Value	-	92.54	76.32	76.32	71.56	71.56	67.2	67.2	46.2
C5-17 (C5-37)	Motor Inertia	kgm ²	0.220	0.273	0.273	0.333	0.333	0.490	0.49	0.90
C6-02	Carrier Frequency Selection	-	1	7	1	7	1	7	1	7
E2-01 (E4-01)	Motor Rated Current (FLA)	A	52.3	65.6	65.6	79.7	79.7	95	95	130
E2-02 (E4-02)	Motor Rated Slip	Hz	1.8	1.33	1.33	1.6	1.6	1.46	1.46	1.39
E2-03 (E4-03)	Motor No-Load Current	A	10.9	19.1	19.1	22	22	24	24	36
E2-05 (E4-05)	Motor Line-to-Line Resistance	Ω	0.269	0.155	0.155	0.122	0.122	0.088	0.088	0.092
E2-06 (E4-06)	Motor Leakage Inductance	%	20.7	18.8	18.8	19.9	19.9	20	20	20
E2-10 (E4-10)	Motor Iron Loss	W	750	925	925	1125	1125	1260	1260	1600
E5-01	PM Motor Code Selection	-	FFFF	FFFF	FFFF	FFFF	FFFF	FFFF	FFFF	FFFF
L2-02	Power Loss Ride Through Time	s	2	2	2	2	2	2	2	2
L2-03	Minimum Baseblock Time	s	1.1	1.1	1.1	1.2	1.2	1.2	1.2	1.3
L2-04	Powerloss V/f Recovery Ramp Time	s	0.6	0.6	0.6	0.6	0.6	1	1	1
L2-05	Undervoltage Detection Lvl (Uv1)	-	380	380	380	380	380	380	380	380
L3-24	Motor Accel Time for Inertia Cal	s	0.323	0.32	0.32	0.387	0.387	0.317	0.317	0.533
L8-02	Overheat Alarm Level	°C	120	120	115	115	126	120	120	120

No.	Name	Unit	Default							
			4075		4089		4103		4140	
-	Drive Model	-	HD	ND	HD	ND	HD	ND	HD	ND
C6-01	Normal / Heavy Duty Selection	-	0	1	0	1	0	1	0	1
o2-04	Drive Model (KVA) Selection	Hex.	A1		A2		A3		A4	
E2-11 (E4-11, E5-02)	Motor Rated Power	HP (kW)	40 (30)	50 (37)	50 (37)	60 (45)	60 (45)	75 (55)	75 (55)	100 (75)
L8-09	Output Ground Fault Detection	-	1	1	1	1	1	1	1	1
L8-38	Carrier Frequency Reduction	-	2	2	2	2	2	2	2	2
n1-01	Hunting Prevention Selection	-	2	2	2	2	2	2	2	2
n1-03	Hunting Prevention Time Constant	ms	10	10	10	10	10	10	30	30
n5-02	Motor Inertia Acceleration Time	s	0.323	0.32	0.32	0.387	0.387	0.317	0.317	0.533

*1 Parameters within parentheses are for motor 2.

No.	Name	Unit	Default							
			4168		4208		4250		4302	
-	Drive Model	-	HD	ND	HD	ND	HD	ND	HD	ND
C6-01	Normal / Heavy Duty Selection	-	0	1	0	1	0	1	0	1
o2-04	Drive Model (KVA) Selection	Hex.	A5		A6		A7		A8	
E2-11 (E4-11, E5-02)	Motor Rated Power	HP (kW)	100 (75)	125 (90)	125 (90)	150 (110)	150 (110)	200 (150)	200 (150)	250 (185)
b3-04	V/f Gain during Speed Search	%	60	60	60	60	60	60	60	60
b3-06	Speed Estimation Current Level 1	-	0.7	0.7	0.7	0.7	0.7	0.7	0.7	0.7
b3-08	Speed Estimation ACR P Gain	-	0.8	0.8	0.8	0.8	0.8	0.8	0.8	0.8
b3-26	Direction Determination Level	-	1000	1000	1000	1000	1000	1000	1000	1000
b8-03	Energy Saving Filter Time	s	2.00	2.00	2.00	2.00	2.00	2.00	2.00	2.00
b8-04	Energy Saving Coefficient Value	-	46.2	38.91	38.91	36.23	36.23	32.79	32.79	30.13
C5-17 (C5-37)	Motor Inertia	kgm ²	0.90	1.10	1.10	1.90	1.90	2.10	2.10	3.30
C6-02	Carrier Frequency Selection	-	1	7	1	7	1	7	1	7
E2-01 (E4-01)	Motor Rated Current (FLA)	A	130	156	156	190	190	223	223	270
E2-02 (E4-02)	Motor Rated Slip	Hz	1.39	1.4	1.4	1.4	1.4	1.38	1.38	1.35

11.21 Defaults by Drive Model and Duty Rating ND/HD

No.	Name	Unit	Default							
			4168		4208		4250		4302	
-	Drive Model	-	HD	ND	HD	ND	HD	ND	HD	ND
C6-01	Normal / Heavy Duty Selection	-	0	1	0	1	0	1	0	1
o2-04	Drive Model (KVA) Selection	Hex.	A5		A6		A7		A8	
E2-11 (E4-11, E5-02)	Motor Rated Power	HP (kW)	100 (75)	125 (90)	125 (90)	150 (110)	150 (110)	200 (150)	200 (150)	250 (185)
E2-03 (E4-03)	Motor No-Load Current	A	36	40	40	49	49	58	58	70
E2-05 (E4-05)	Motor Line-to-Line Resistance	Ω	0.092	0.056	0.056	0.046	0.046	0.035	0.035	0.029
E2-06 (E4-06)	Motor Leakage Inductance	%	20	20	20	20	20	20	20	20
E2-10 (E4-10)	Motor Iron Loss	W	1600	1760	1760	2150	2150	2350	2350	2850
E5-01	PM Motor Code Selection	-	FFFF	FFFF	FFFF	FFFF	FFFF	FFFF	FFFF	FFFF
L2-02	Power Loss Ride Through Time	s	2	2	2	2	2	2	2	2
L2-03	Minimum Baseblock Time	s	1.3	1.5	1.5	1.7	1.7	1.7	1.7	1.8
L2-04	Powerloss V/f Recovery Ramp Time	s	1	1	1	1	1	1	1	1
L2-05	Undervoltage Detection Lvl (Uv1)	-	380	380	380	380	380	380	380	380
L3-24	Motor Accel Time for Inertia Cal	s	0.533	0.592	0.592	0.646	0.646	0.673	0.673	0.777
L8-02	Overheat Alarm Level	°C	110	110	105	105	120	120	120	120
L8-09	Output Ground Fault Detection	-	1	1	1	1	1	1	1	1
L8-38	Carrier Frequency Reduction	-	2	2	2	2	2	2	2	2
n1-01	Hunting Prevention Selection	-	2	2	2	2	2	2	2	2
n1-03	Hunting Prevention Time Constant	ms	30	30	30	30	30	30	30	30
n5-02	Motor Inertia Acceleration Time	s	0.533	0.592	0.592	0.646	0.646	0.673	0.673	0.777

*1 Parameters within parentheses are for motor 2.

No.	Name	Unit	Default							
			4371		4414		4477		4568	
-	Drive Model	-	HD	ND	HD	ND	HD	ND	HD	ND
C6-01	Normal / Heavy Duty Selection	-	0	1	0	1	0	1	0	1
o2-04	Drive Model (KVA) Selection	Hex.	A9		AA		AC		AD	
E2-11 (E4-11, E5-02)	Motor Rated Power	HP (kW)	250 (185)	300 (220)	300 (220)	350 (260)	350 (260)	400 (300)	400 (300)	450 (335)
b3-04	V/f Gain during Speed Search	%	60	60	60	60	60	60	60	60
b3-06	Speed Estimation Current Level 1	-	0.7	0.7	0.7	0.7	0.7	0.7	0.7	0.7
b3-08	Speed Estimation ACR P Gain	-	0.8	0.8	0.8	0.8	0.8	0.8	0.8	0.8
b3-26	Direction Determination Level	-	1000	1000	1000	1000	1000	1000	1000	1000
b8-03	Energy Saving Filter Time	s	2.00	2.00	2.00	2.00	2.00	2.00	2.00	2.00
b8-04	Energy Saving Coefficient Value	-	30.13	30.57	30.57	27.13	27.13	21.76	21.76	21.76
C5-17 (C5-37)	Motor Inertia	kgm ²	3.30	3.60	3.60	4.10	4.10	6.50	6.50	11.00
C6-02	Carrier Frequency Selection	-	1	7	1	7	1	7	1	7
E2-01 (E4-01)	Motor Rated Current (FLA)	A	270	310	310	370	370	500	500	500
E2-02 (E4-02)	Motor Rated Slip	Hz	1.35	1.3	1.3	1.3	1.3	1.25	1.25	1.25
E2-03 (E4-03)	Motor No-Load Current	A	70	81	81	96	96	130	130	130
E2-05 (E4-05)	Motor Line-to-Line Resistance	Ω	0.029	0.025	0.025	0.02	0.02	0.014	0.014	0.014
E2-06 (E4-06)	Motor Leakage Inductance	%	20	20	20	20	20	20	20	20
E2-10 (E4-10)	Motor Iron Loss	W	2850	3200	3200	3700	3700	4700	4700	4700
E5-01	PM Motor Code Selection	-	FFFF	FFFF	FFFF	FFFF	FFFF	FFFF	FFFF	FFFF
L2-02	Power Loss Ride Through Time	s	2	2	2	2	2	2	2	2
L2-03	Minimum Baseblock Time	s	1.8	1.9	1.9	2	2	2.1	2.1	2.1
L2-04	Powerloss V/f Recovery Ramp Time	s	1	1	1.8	1.8	1.8	2	2	2
L2-05	Undervoltage Detection Lvl (Uv1)	-	380	380	380	380	380	380	380	380
L3-24	Motor Accel Time for Inertia Cal	s	0.777	0.864	0.864	0.91	0.91	1.392	1.392	1.392
L8-02	Overheat Alarm Level	°C	125	125	125	125	110	110	125	115

11.21 Defaults by Drive Model and Duty Rating ND/HD

No.	Name	Unit	Default							
			4371		4414		4477		4568	
-	Drive Model	-								
C6-01	Normal / Heavy Duty Selection	-	HD	ND	HD	ND	HD	ND	HD	ND
			0	1	0	1	0	1	0	1
o2-04	Drive Model (KVA) Selection	Hex.	A9		AA		AC		AD	
E2-11 (E4-11, E5-02)	Motor Rated Power	HP (kW)	250 (185)	300 (220)	300 (220)	350 (260)	350 (260)	400 (300)	400 (300)	450 (335)
L8-09	Output Ground Fault Detection	-	1	1	1	1	1	1	1	1
L8-38	Carrier Frequency Reduction	-	2	2	2	2	2	2	2	2
n1-01	Hunting Prevention Selection	-	2	2	2	2	2	2	2	2
n1-03	Hunting Prevention Time Constant	ms	30	30	100	100	100	100	100	100
n5-02	Motor Inertia Acceleration Time	s	0.777	0.864	0.864	0.91	0.91	1.392	1.392	1.392

*1 Parameters within parentheses are for motor 2.

No.	Name	Unit	Default			
			4605		4720	
-	Drive Model	-				
C6-01	Normal / Heavy Duty Selection	-	HD	ND	HD	ND
			0	1	0	1
o2-04	Drive Model (KVA) Selection	Hex.	AE		AF	
E2-11 (E4-11, E5-02)	Motor Rated Power	HP (kW)	450 (335)	500 (370)	500 (370)	600 (450)
b3-04	V/f Gain during Speed Search	%	60	60	60	60
b3-06	Speed Estimation Current Level 1	-	0.7	0.7	0.7	0.7
b3-08	Speed Estimation ACR P Gain	-	0.8	0.8	0.8	0.8
b3-26	Direction Determination Level	-	1000	1000	1000	1000
b8-03	Energy Saving Filter Time	s	2.00	2.00	2.00	2.00
b8-04	Energy Saving Coefficient Value	-	21.76	23.84	21.76	23.84
C5-17 (C5-37)	Motor Inertia	kgm ²	11.00	12.00	11.00	12.00
C6-02	Carrier Frequency Selection	-	1	7	1	7
E2-01 (E4-01)	Motor Rated Current (FLA)	A	500	650	500	650
E2-02 (E4-02)	Motor Rated Slip	Hz	1.25	1	1.25	1
E2-03 (E4-03)	Motor No-Load Current	A	130	130	130	130
E2-05 (E4-05)	Motor Line-to-Line Resistance	Ω	0.014	0.012	0.014	0.012

No.	Name	Unit	Default			
			4605		4720	
-	Drive Model	-				
C6-01	Normal / Heavy Duty Selection	-	HD	ND	HD	ND
			0	1	0	1
o2-04	Drive Model (KVA) Selection	Hex.	AE		AF	
E2-11 (E4-11, E5-02)	Motor Rated Power	HP (kW)	450 (335)	500 (370)	500 (370)	600 (450)
E2-06 (E4-06)	Motor Leakage Inductance	%	20	20	20	20
E2-10 (E4-10)	Motor Iron Loss	W	4700	5560	4700	5560
E5-01	PM Motor Code Selection	-	FFFF	FFFF	FFFF	FFFF
L2-02	Power Loss Ride Through Time	s	2	2	2	2
L2-03	Minimum Baseblock Time	s	2.1	2.3	2.1	2.3
L2-04	Powerloss V/f Recovery Ramp Time	s	2	2.2	2	2.2
L2-05	Undervoltage Detection Lvl (Uv1)	-	380	380	380	380
L3-24	Motor Accel Time for Inertia Cal	s	1.392	1.667	1.392	1.667
L8-02	Overheat Alarm Level	°C	133	133	125	125
L8-09	Output Ground Fault Detection	-	1	1	1	1
L8-38	Carrier Frequency Reduction	-	2	2	2	2
n1-01	Hunting Prevention Selection	-	2	2	2	2
n1-03	Hunting Prevention Time Constant	ms	100	100	100	100
n5-02	Motor Inertia Acceleration Time	s	1.392	1.667	1.392	1.667

*1 Parameters within parentheses are for motor 2.

11.22 Parameters Changed by PM Motor Code Selection

Note:

The motor codes listed in these tables are the only correct setting values.

◆ Yaskawa SMRA Series SPM Motors

Table 11.4 SMRA series motor code setting for specification of 200 V at 1800 min⁻¹ (r/min)

No.	Name	Unit	Motor Code (setting value of E5-01)				
E5-01	PM Motor Code Selection	-	0002	0003	0005	0006	0008
	Voltage Class	V	200	200	200	200	200
	Capacity	kW	0.4	0.75	1.5	2.2	3.7
	Motor Rotation Speed	min ⁻¹	1800	1800	1800	1800	1800
E5-02	PM Motor Rated Power	kW	0.4	0.75	1.5	2.2	3.7
E5-03	PM Motor Rated Current (FLA)	A	2.1	4.0	6.9	10.8	17.4
E5-04	PM Motor Pole Count	-	8	8	8	8	8
E5-05	PM Motor Resistance (ohms/phase)	Ω	2.47	1.02	0.679	0.291	0.169
E5-06	PM d-axis Inductance (mH/phase)	mH	12.7	4.8	3.9	3.6	2.5
E5-07	PM q-axis Inductance (mH/phase)	mH	12.7	4.8	3.9	3.6	2.5
E5-09	PM Back-EMF Vpeak (mV/(rad/s))	mVs/rad	0	0	0	0	0
E5-24	PM Back-EMF L-L Vrms (mV/rpm)	mV/min ⁻¹	62.0	64.1	73.4	69.6	72.2
E1-04	Maximum Output Frequency	Hz	120	120	120	120	120
E1-05	Maximum Output Voltage	V	200.0	200.0	200.0	200.0	200.0
E1-06	Base Frequency	Hz	120	120	120	120	120
E1-09	Minimum Output Frequency	Hz	6	6	6	6	6
C5-17	Motor Inertia	kgm ²	0.0007	0.0014	0.0021	0.0032	0.0046
L3-24	Motor Accel Time @ Rated Torque	s	0.064	0.066	0.049	0.051	0.044
n5-02	Motor Inertia Acceleration Time	s	0.064	0.066	0.049	0.051	0.044
n8-49	Heavy Load Id Current	%	0	0	0	0	0

Table 11.5 SMRA Series Motor Code Setting for Specification of 200 V at 3600 min⁻¹ (r/min)

No.	Name	Unit	Motor Code (setting value of E5-01)			
E5-01	PM Motor Code Selection	-	0103	0105	0106	0108
	Voltage Class	V	200	200	200	200
	Capacity	kW	0.75	1.5	2.2	3.7
	Motor Rotation Speed	min ⁻¹	3600	3600	3600	3600
E5-02	PM Motor Rated Power	kW	0.75	1.5	2.2	3.7
E5-03	PM Motor Rated Current (FLA)	A	4.1	8.0	10.5	16.5
E5-04	PM Motor Pole Count	-	8	8	8	8
E5-05	PM Motor Resistance (ohms/phase)	Ω	0.538	0.20	0.15	0.097
E5-06	PM d-axis Inductance (mH/phase)	mH	3.2	1.3	1.1	1.1
E5-07	PM q-axis Inductance (mH/phase)	mH	3.2	1.3	1.1	1.1

No.	Name	Unit	Motor Code (setting value of E5-01)			
E5-09	PM Back-EMF Vpeak (mV/(rad/s))	mVs/rad	0	0	0	0
E5-24	PM Back-EMF L-L Vrms (mV/rpm)	mV/min ⁻¹	32.4	32.7	36.7	39.7
E1-04	Maximum Output Frequency	Hz	240	240	240	240
E1-05	Maximum Output Voltage	V	200.0	200.0	200.0	200.0
E1-06	Base Frequency	Hz	240	240	240	240
E1-09	Minimum Output Frequency	Hz	12	12	12	12
C5-17	Motor Inertia	kgm ²	0.0007	0.0014	0.0021	0.0032
L3-24	Motor Accel Time @ Rated Torque	s	0.137	0.132	0.132	0.122
n5-02	Motor Inertia Acceleration Time	s	0.137	0.132	0.132	0.122
n8-49	Heavy Load Id Current	%	0	0	0	0

◆ Yaskawa SSR1 Series IPM Motors (Derated Torque)

Table 11.6 SSR1 Series Motor Code Setting for Specification of 200 V at 1750 min⁻¹ (r/min)

No.	Name	Unit	Motor Code (setting value of E5-01)							
E5-01	PM Motor Code Selection	-	1202	1203	1205	1206	1208	120A	120B	120D
	Voltage Class	V	200	200	200	200	200	200	200	200
	Capacity	kW	0.4	0.75	1.5	2.2	3.7	5.5	7.5	11
	Motor Rotation Speed	min ⁻¹	1750	1750	1750	1750	1750	1750	1750	1750
E5-02	PM Motor Rated Power	kW	0.4	0.75	1.5	2.2	3.7	5.5	7.5	11.0
E5-03	PM Motor Rated Current (FLA)	A	1.77	3.13	5.73	8.44	13.96	20.63	28.13	41.4
E5-04	PM Motor Pole Count	-	6	6	6	6	6	6	6	6
E5-05	PM Motor Resistance (ohms/phase)	Ω	8.233	2.284	1.470	0.827	0.455	0.246	0.198	0.094
E5-06	PM d-axis Inductance (mH/phase)	mH	54.84	23.02	17.22	8.61	7.20	4.86	4.15	3.40
E5-07	PM q-axis Inductance (mH/phase)	mH	64.10	29.89	20.41	13.50	10.02	7.43	5.91	3.91
E5-09	PM Back-EMF Vpeak (mV/(rad/s))	mVs/rad	223.7	220.3	240.8	238.0	238.7	239.6	258.2	239.3
E5-24	PM Back-EMF L-L Vrms (mV/rpm)	mV/min ⁻¹	0.0	0.0	0.0	0.0	0.0	0.0	0.0	0.0
E1-04	Maximum Output Frequency	Hz	87.5	87.5	87.5	87.5	87.5	87.5	87.5	87.5
E1-05	Maximum Output Voltage	V	190.0	190.0	190.0	190.0	190.0	190.0	190.0	190.0
E1-06	Base Frequency	Hz	87.5	87.5	87.5	87.5	87.5	87.5	87.5	87.5
E1-09	Minimum Output Frequency	Hz	4.4	4.4	4.4	4.4	4.4	4.4	4.4	4.4
C5-17	Motor Inertia	kgm ²	0.0011	0.0017	0.0023	0.0043	0.0083	0.014	0.017	0.027
L3-24 *1	Motor Accel Time @ Rated Torque	s	0.092	0.076	0.051	0.066	0.075	0.083	0.077	0.084
n5-02	Motor Inertia Acceleration Time	s	0.092	0.076	0.051	0.066	0.075	0.083	0.077	0.084
n8-49	Heavy Load Id Current	%	-7.6	-11.5	-9.1	-19.0	-18.7	-23.4	-18.5	-10.9

*1 The default setting changes when the setting for o2-04 [Drive Model Selection] changes.

11.22 Parameters Changed by PM Motor Code Selection

Table 11.7 SSR1 Series Motor Code Setting for Specification of 200 V at 1750 min⁻¹ (r/min)

No.	Name	Unit	Motor Code (setting value of E5-01)							
E5-01	PM Motor Code Selection	-	120E	120F	1210	1212	1213	1214	1215	1216
	Voltage Class	V	200	200	200	200	200	200	200	200
	Capacity	kW	15	18	22	30	37	45	55	75
	Motor Rotation Speed	min ⁻¹	1750	1750	1750	1750	1750	1750	1750	1750
E5-02	PM Motor Rated Power	kW	15.00	18.50	22.00	30.00	37.00	45.00	55.00	75.00
E5-03	PM Motor Rated Current (FLA)	A	55.4	68.2	80.6	105.2	131.3	153.1	185.4	257.3
E5-04	PM Motor Pole Count	-	6	6	6	6	6	6	6	6
E5-05	PM Motor Resistance (ohms/phase)	Ω	0.066	0.051	0.037	0.030	0.020	0.014	0.012	0.006
E5-06	PM d-axis Inductance (mH/phase)	mH	2.45	2.18	1.71	1.35	0.99	0.83	0.79	0.44
E5-07	PM q-axis Inductance (mH/phase)	mH	3.11	2.55	2.05	1.82	1.28	1.01	0.97	0.56
E5-09	PM Back-EMF V _{peak} (mV/(rad/s))	mVs/rad	248.1	253.6	250.0	280.9	264.2	280.4	311.9	268.0
E5-24	PM Back-EMF L-L V _{rms} (mV/rpm)	mV/min ⁻¹	0.0	0.0	0.0	0.0	0.0	0.0	0.0	0.0
E1-04	Maximum Output Frequency	Hz	87.5	87.5	87.5	87.5	87.5	87.5	87.5	87.5
E1-05	Maximum Output Voltage	V	190.0	190.0	190.0	190.0	190.0	190.0	190.0	190.0
E1-06	Base Frequency	Hz	87.5	87.5	87.5	87.5	87.5	87.5	87.5	87.5
E1-09	Minimum Output Frequency	Hz	4.4	4.4	4.4	4.4	4.4	4.4	4.4	4.4
C5-17	Motor Inertia	kgm ²	0.046	0.055	0.064	0.116	0.140	0.259	0.31	0.42
L3-24 *1	Motor Accel Time @ Rated Torque	s	0.102	0.101	0.098	0.130	0.127	0.193	0.191	0.187
n5-02	Motor Inertia Acceleration Time	s	0.102	0.101	0.098	0.130	0.127	0.193	0.191	0.187
n8-49	Heavy Load Id Current	%	-16.5	-11.3	-12.8	-16.8	-15.6	-10.7	-9.6	-13.3

*1 The default setting changes when the setting for o2-04 [Drive Model Selection] changes.

Table 11.8 SSR1 Series Motor Code Setting for Specification of 400 V at 1750 min⁻¹ (r/min)

No.	Name	Unit	Motor Code (setting value of E5-01)							
E5-01	PM Motor Code Selection	-	1232	1233	1235	1236	1238	123A	123B	123D
	Voltage Class	V	400	400	400	400	400	400	400	400
	Capacity	kW	0.4	0.75	1.5	2.2	3.7	5.5	7.5	11
	Motor Rotation Speed	min ⁻¹	1750	1750	1750	1750	1750	1750	1750	1750
E5-02	PM Motor Rated Power	kW	0.4	0.75	1.5	2.2	3.7	5.5	7.5	11.0
E5-03	PM Motor Rated Current (FLA)	A	0.89	1.56	2.81	4.27	7.08	10.31	13.65	20.7
E5-04	PM Motor Pole Count	-	6	6	6	6	6	6	6	6
E5-05	PM Motor Resistance (ohms/phase)	Ω	25.370	9.136	6.010	3.297	1.798	0.982	0.786	0.349
E5-06	PM d-axis Inductance (mH/phase)	mH	169.00	92.08	67.71	34.40	32.93	22.7	16.49	13.17
E5-07	PM q-axis Inductance (mH/phase)	mH	197.50	119.56	81.71	54.00	37.70	26.80	23.46	15.60
E5-09	PM Back-EMF V _{peak} (mV/(rad/s))	mVs/rad	392.6	440.6	478.3	466.3	478.8	478.1	520.0	481.5

No.	Name	Unit	Motor Code (setting value of E5-01)							
E5-24	PM Back-EMF L-L Vrms (mV/rpm)	mV/min ⁻¹	0.0	0.0	0.0	0.0	0.0	0.0	0.0	0.0
E1-04	Maximum Output Frequency	Hz	87.5	87.5	87.5	87.5	87.5	87.5	87.5	87.5
E1-05	Maximum Output Voltage	V	380.0	380.0	380.0	380.0	380.0	380.0	380.0	380.0
E1-06	Base Frequency	Hz	87.5	87.5	87.5	87.5	87.5	87.5	87.5	87.5
E1-09	Minimum Output Frequency	Hz	4.4	4.4	4.4	4.4	4.4	4.4	4.4	4.4
C5-17	Motor Inertia	kgm ²	0.0011	0.0017	0.0023	0.0043	0.0083	0.014	0.017	0.027
L3-24 */	Motor Accel Time @ Rated Torque	s	0.092	0.076	0.051	0.066	0.075	0.083	0.077	0.084
n5-02	Motor Inertia Acceleration Time	s	0.092	0.076	0.051	0.066	0.075	0.083	0.077	0.084
n8-49	Heavy Load Id Current	%	-8.6	-11.5	-10.3	-19.8	-8.5	-11.0	-18.6	-12.5

*1 The default setting changes when the setting for o2-04 [Drive Model Selection] changes.

Table 11.9 SSR1 Series Motor Code Setting for Specification of 400 V at 1750 min⁻¹ (r/min)

No.	Name	Unit	Motor Code (setting value of E5-01)							
E5-01	PM Motor Code Selection	-	123E	123F	1240	1242	1243	1244	1245	1246
	Voltage Class	V	400	400	400	400	400	400	400	400
	Capacity	kW	15	18	22	30	37	45	55	75
	Motor Rotation Speed	min ⁻¹	1750	1750	1750	1750	1750	1750	1750	1750
E5-02	PM Motor Rated Power	kW	15	18.50	22.00	30.00	37.00	45.00	55.00	75.00
E5-03	PM Motor Rated Current (FLA)	A	27.5	33.4	39.8	52.0	65.8	77.5	92.7	126.6
E5-04	PM Motor Pole Count	-	6	6	6	6	6	6	6	6
E5-05	PM Motor Resistance (ohms/phase)	Ω	0.272	0.207	0.148	0.235	0.079	0.054	0.049	0.029
E5-06	PM d-axis Inductance (mH/phase)	mH	10.30	8.72	6.81	5.4	4.08	3.36	3.16	2.12
E5-07	PM q-axis Inductance (mH/phase)	mH	12.77	11.22	8.47	7.26	5.12	3.94	3.88	2.61
E5-09	PM Back-EMF Vpeak (mV/(rad/s))	mVs/rad	498.8	509.5	503.9	561.7	528.5	558.1	623.8	594.5
E5-24	PM Back-EMF L-L Vrms (mV/rpm)	mV/min ⁻¹	0.0	0.0	0.0	0.0	0.0	0.0	0.0	0.0
E1-04	Maximum Output Frequency	Hz	87.5	87.5	87.5	87.5	87.5	87.5	87.5	87.5
E1-05	Maximum Output Voltage	V	380.0	380.0	380.0	380.0	380.0	380.0	380.0	380.0
E1-06	Base Frequency	Hz	87.5	87.5	87.5	87.5	87.5	87.5	87.5	87.5
E1-09	Minimum Output Frequency	Hz	4.4	4.4	4.4	4.4	4.4	4.4	4.4	4.4
C5-17	Motor Inertia	kgm ²	0.046	0.055	0.064	0.116	0.140	0.259	0.31	0.42
L3-24 */	Motor Accel Time @ Rated Torque	s	0.102	0.101	0.098	0.130	0.127	0.193	0.191	0.187
n5-02	Motor Inertia Acceleration Time	s	0.102	0.101	0.098	0.130	0.127	0.193	0.191	0.187
n8-49	Heavy Load Id Current	%	-15.5	-17.9	-15.1	-16.8	-14.1	-8.8	-9.6	-10.3

*1 The default setting changes when the setting for o2-04 [Drive Model Selection] changes.

11.22 Parameters Changed by PM Motor Code Selection

Table 11.10 SSR1 Series Motor Code Setting for Specification of 400 V at 1750 min⁻¹ (r/min)

No.	Name	Unit	Motor Code (setting value of E5-01)			
E5-01	PM Motor Code Selection	-	1247	1248	1249	124A
	Voltage Class	V	400	400	400	400
	Capacity	kW	90	110	132	160
	Motor Rotation Speed	min ⁻¹	1750	1750	1750	1750
E5-02	PM Motor Rated Power	kW	90.00	110.00	132.00	160.00
E5-03	PM Motor Rated Current (FLA)	A	160.4	183.3	222.9	267.7
E5-04	PM Motor Pole Count	-	6	6	6	6
E5-05	PM Motor Resistance (ohms/phase)	Ω	0.019	0.017	0.012	0.008
E5-06	PM d-axis Inductance (mH/phase)	mH	1.54	1.44	1.21	0.97
E5-07	PM q-axis Inductance (mH/phase)	mH	2.06	2.21	1.46	1.28
E5-09	PM Back-EMF V _{peak} (mV/(rad/s))	mVs/rad	524.1	583.7	563.6	601.2
E5-24	PM Back-EMF L-L V _{rms} (mV/rpm)	mV/min ⁻¹	0.0	0.0	0.0	0.0
E1-04	Maximum Output Frequency	Hz	87.5	87.5	87.5	87.5
E1-05	Maximum Output Voltage	V	380.0	380.0	380.0	380.0
E1-06	Base Frequency	Hz	87.5	87.5	87.5	87.5
E1-09	Minimum Output Frequency	Hz	4.4	4.4	4.4	4.4
C5-17	Motor Inertia	kgm ²	0.56	0.83	0.96	1.61
L3-24 *J	Motor Accel Time @ Rated Torque	s	0.208	0.254	0.243	0.338
n5-02	Motor Inertia Acceleration Time	s	0.208	0.254	0.243	0.338
n8-49	Heavy Load Id Current	%	-17.0	-21.7	-10.9	-13.2

*1 The default setting changes when the setting for o2-04 [Drive Model Selection] changes.

Table 11.11 SSR1 Series Motor Code Setting for Specification of 200 V at 1450 min⁻¹ (r/min)

No.	Name	Unit	Motor Code (setting value of E5-01)							
E5-01	PM Motor Code Selection	-	1302	1303	1305	1306	1308	130A	130B	130D
	Voltage Class	V	200	200	200	200	200	200	200	200
	Capacity	kW	0.4	0.75	1.5	2.2	3.7	5.5	7.5	11
	Motor Rotation Speed	min ⁻¹	1450	1450	1450	1450	1450	1450	1450	1450
E5-02	PM Motor Rated Power	kW	0.4	0.75	1.5	2.2	3.7	5.5	7.5	11.0
E5-03	PM Motor Rated Current (FLA)	A	1.88	3.13	5.63	8.33	14.17	20.63	27.71	39.6
E5-04	PM Motor Pole Count	-	6	6	6	6	6	6	6	6
E5-05	PM Motor Resistance (ohms/phase)	Ω	3.190	1.940	1.206	0.665	0.341	0.252	0.184	0.099
E5-06	PM d-axis Inductance (mH/phase)	mH	32.15	26.12	14.72	12.27	8.27	6.49	6.91	4.07
E5-07	PM q-axis Inductance (mH/phase)	mH	41.74	34.30	20.15	14.77	9.81	7.74	7.66	4.65
E5-09	PM Back-EMF V _{peak} (mV/(rad/s))	mVs/rad	264.3	269.6	284.3	287.1	284.5	298.0	335.0	303.9
E5-24	PM Back-EMF L-L V _{rms} (mV/rpm)	mV/min ⁻¹	0.0	0.0	0.0	0.0	0.0	0.0	0.0	0.0
E1-04	Maximum Output Frequency	Hz	72.5	72.5	72.5	72.5	72.5	72.5	72.5	72.5
E1-05	Maximum Output Voltage	V	190.0	190.0	190.0	190.0	190.0	190.0	190.0	190.0
E1-06	Base Frequency	Hz	72.5	72.5	72.5	72.5	72.5	72.5	72.5	72.5

11.22 Parameters Changed by PM Motor Code Selection

No.	Name	Unit	Motor Code (setting value of E5-01)							
E1-09	Minimum Output Frequency	Hz	3.6	3.6	3.6	3.6	3.6	3.6	3.6	3.6
C5-17	Motor Inertia	kgm ²	0.0017	0.0023	0.0043	0.0083	0.0136	0.017	0.027	0.046
L3-24 *J	Motor Accel Time @ Rated Torque	s	0.098	0.071	0.066	0.087	0.085	0.072	0.084	0.096
n5-02	Motor Inertia Acceleration Time	s	0.098	0.071	0.066	0.087	0.085	0.072	0.084	0.096
n8-49	Heavy Load Id Current	%	-6.6	-10.9	-13.5	-9.0	-9.5	-10.1	-6.0	-9.3

*1 The default setting changes when the setting for o2-04 [Drive Model Selection] changes.

Table 11.12 SSR1 Series Motor Code Setting for Specification of 200 V at 1450 min⁻¹ (r/min)

No.	Name	Unit	Motor Code (setting value of E5-01)							
E5-01	PM Motor Code Selection	-	130E	130F	1310	1312	1313	1314	1315	
	Voltage Class	V	200	200	200	200	200	200	200	
	Capacity	kW	15	18	22	30	37	45	55	
	Motor Rotation Speed	min ⁻¹	1450	1450	1450	1450	1450	1450	1450	
E5-02	PM Motor Rated Power	kW	15.00	18.50	22.00	30.00	37.00	45.00	55.00	
E5-03	PM Motor Rated Current (FLA)	A	55.5	65.6	75.1	105.2	126.0	153.1	186.5	
E5-04	PM Motor Pole Count	-	6	6	6	6	6	6	6	
E5-05	PM Motor Resistance (ohms/phase)	Ω	0.075	0.057	0.041	0.034	0.023	0.015	0.012	
E5-06	PM d-axis Inductance (mH/phase)	mH	3.29	2.53	1.98	1.75	1.48	1.04	0.87	
E5-07	PM q-axis Inductance (mH/phase)	mH	3.84	3.01	2.60	2.17	1.70	1.31	1.10	
E5-09	PM Back-EMF Vpeak (mV/(rad/s))	mVs/rad	311.2	300.9	327.7	354.2	369.6	351.6	374.7	
E5-24	PM Back-EMF L-L Vrms (mV/rpm)	mV/min ⁻¹	0.0	0.0	0.0	0.0	0.0	0.0	0.0	
E1-04	Maximum Output Frequency	Hz	72.5	72.5	72.5	72.5	72.5	72.5	72.5	
E1-05	Maximum Output Voltage	V	190.0	190.0	190.0	190.0	190.0	190.0	190.0	
E1-06	Base Frequency	Hz	72.5	72.5	72.5	72.5	72.5	72.5	72.5	
E1-09	Minimum Output Frequency	Hz	3.6	3.6	3.6	3.6	3.6	3.6	3.6	
C5-17	Motor Inertia	kgm ²	0.055	0.064	0.116	0.140	0.259	0.312	0.42	
L3-24 *J	Motor Accel Time @ Rated Torque	s	0.085	0.080	0.122	0.108	0.161	0.160	0.175	
n5-02	Motor Inertia Acceleration Time	s	0.085	0.080	0.122	0.108	0.161	0.160	0.175	
n8-49	Heavy Load Id Current	%	-10.7	-13.2	-15.7	-11.5	-7.0	-11.8	-10.2	

*1 The default setting changes when the setting for o2-04 [Drive Model Selection] changes.

Table 11.13 SSR1 Series Motor Code Setting for Specification of 400 V at 1450 min⁻¹ (r/min)

No.	Name	Unit	Motor Code (setting value of E5-01)							
E5-01	PM Motor Code Selection	-	1332	1333	1335	1336	1338	133A	133B	133D
	Voltage Class	V	400	400	400	400	400	400	400	400
	Capacity	kW	0.4	0.75	1.5	2.2	3.7	5.5	7.5	11
	Motor Rotation Speed	min ⁻¹	1450	1450	1450	1450	1450	1450	1450	1450
E5-02	PM Motor Rated Power	kW	0.4	0.75	1.5	2.2	3.7	5.5	7.5	11.0

11.22 Parameters Changed by PM Motor Code Selection

No.	Name	Unit	Motor Code (setting value of E5-01)							
E5-03	PM Motor Rated Current (FLA)	A	0.94	1.56	2.81	4.27	6.98	10.21	13.85	19.5
E5-04	PM Motor Pole Count	-	6	6	6	6	6	6	6	6
E5-05	PM Motor Resistance (ohms/phase)	Ω	12.760	7.421	4.825	2.656	1.353	0.999	0.713	0.393
E5-06	PM d-axis Inductance (mH/phase)	mH	128.60	85.11	58.87	46.42	31.73	26.20	27.06	15.51
E5-07	PM q-axis Inductance (mH/phase)	mH	166.96	113.19	80.59	60.32	40.45	30.94	33.45	19.63
E5-09	PM Back-EMF V _{peak} (mV/(rad/s))	mVs/rad	528.6	544.2	568.5	572.8	562.9	587.6	670.1	612.7
E5-24	PM Back-EMF L-L V _{rms} (mV/rpm)	mV/min ⁻¹	0.0	0.0	0.0	0.0	0.0	0.0	0.0	0.0
E1-04	Maximum Output Frequency	Hz	72.5	72.5	72.5	72.5	72.5	72.5	72.5	72.5
E1-05	Maximum Output Voltage	V	380.0	380.0	380.0	380.0	380.0	380.0	380.0	380.0
E1-06	Base Frequency	Hz	72.5	72.5	72.5	72.5	72.5	72.5	72.5	72.5
E1-09	Minimum Output Frequency	Hz	3.6	3.6	3.6	3.6	3.6	3.6	3.6	3.6
C5-17	Motor Inertia	kgm ²	0.0017	0.0023	0.0043	0.0083	0.0136	0.017	0.027	0.046
L3-24 *7	Motor Accel Time @ Rated Torque	s	0.098	0.071	0.066	0.087	0.085	0.072	0.084	0.096
n5-02	Motor Inertia Acceleration Time	s	0.098	0.071	0.066	0.087	0.085	0.072	0.084	0.096
n8-49	Heavy Load Id Current	%	-6.6	-9.2	-13.5	-12.1	-13.7	-10.1	-12.2	-15.5

*1 The default setting changes when the setting for o2-04 [Drive Model Selection] changes.

Table 11.14 SSR1 Series Motor Code Setting for Specification of 400 V at 1450 min⁻¹ (r/min)

No.	Name	Unit	Motor Code (setting value of E5-01)							
E5-01	PM Motor Code Selection	-	133E	133F	1340	1342	1343	1344	1345	
	Voltage Class	V	400	400	400	400	400	400	400	
	Capacity	kW	15	18	22	30	37	45	55	
	Motor Rotation Speed	min ⁻¹	1450	1450	1450	1450	1450	1450	1450	
E5-02	PM Motor Rated Power	kW	15	18.50	22.00	30.00	37.00	45.00	55.00	
E5-03	PM Motor Rated Current (FLA)	A	27.4	32.9	37.6	52.5	63.2	76.4	96.1	
E5-04	PM Motor Pole Count	-	6	6	6	6	6	6	6	
E5-05	PM Motor Resistance (ohms/phase)	Ω	0.295	0.223	0.164	0.137	0.093	0.059	0.048	
E5-06	PM d-axis Inductance (mH/phase)	mH	12.65	9.87	7.90	7.01	5.93	4.17	3.11	
E5-07	PM q-axis Inductance (mH/phase)	mH	15.87	12.40	10.38	8.68	6.79	5.22	4.55	
E5-09	PM Back-EMF V _{peak} (mV/(rad/s))	mVs/rad	624.6	610.4	655.4	708.4	739.2	703.0	747.1	
E5-24	PM Back-EMF L-L V _{rms} (mV/rpm)	mV/min ⁻¹	0.0	0.0	0.0	0.0	0.0	0.0	0.0	
E1-04	Maximum Output Frequency	Hz	72.5	72.5	72.5	72.5	72.5	72.5	72.5	
E1-05	Maximum Output Voltage	V	380.0	380.0	380.0	380.0	380.0	380.0	380.0	
E1-06	Base Frequency	Hz	72.5	72.5	72.5	72.5	72.5	72.5	72.5	
E1-09	Minimum Output Frequency	Hz	3.6	3.6	3.6	3.6	3.6	3.6	3.6	
C5-17	Motor Inertia	kgm ²	0.055	0.064	0.116	0.140	0.259	0.312	0.42	

No.	Name	Unit	Motor Code (setting value of E5-01)						
L3-24 */	Motor Accel Time @ Rated Torque	s	0.085	0.080	0.122	0.108	0.161	0.160	0.175
n5-02	Motor Inertia Acceleration Time	s	0.085	0.080	0.122	0.108	0.161	0.160	0.175
n8-49	Heavy Load Id Current	%	-15.1	-16.0	-15.7	-11.5	-6.8	-11.5	-14.8

*1 The default setting changes when the setting for o2-04 [Drive Model Selection] changes.

Table 11.15 SSR1 Series Motor Code Setting for Specification of 400 V at 1450 min⁻¹ (r/min)

No.	Name	Unit	Motor Code (setting value of E5-01)			
E5-01	PM Motor Code Selection	-	1346	1347	1348	1349
	Voltage Class	V	400	400	400	400
	Capacity	kW	75	90	110	132
	Motor Rotation Speed	min ⁻¹	1450	1450	1450	1450
E5-02	PM Motor Rated Power	kW	75.00	90.00	110.00	132.00
E5-03	PM Motor Rated Current (FLA)	A	124.0	153.1	186.5	226.0
E5-04	PM Motor Pole Count	-	6	6	6	6
E5-05	PM Motor Resistance (ohms/phase)	Ω	0.028	0.024	0.015	0.011
E5-06	PM d-axis Inductance (mH/phase)	mH	2.32	2.20	1.45	1.23
E5-07	PM q-axis Inductance (mH/phase)	mH	2.97	3.23	1.88	1.67
E5-09	PM Back-EMF Vpeak (mV/(rad/s))	mVs/rad	639.3	708.0	640.7	677.0
E5-24	PM Back-EMF L-L Vrms (mV/rpm)	mV/min ⁻¹	0.0	0.0	0.0	0.0
E1-04	Maximum Output Frequency	Hz	72.5	72.5	72.5	72.5
E1-05	Maximum Output Voltage	V	380.0	380.0	380.0	380.0
E1-06	Base Frequency	Hz	72.5	72.5	72.5	72.5
E1-09	Minimum Output Frequency	Hz	3.6	3.6	3.6	3.6
C5-17	Motor Inertia	kgm ²	0.56	0.83	0.96	1.61
L3-24 */	Motor Accel Time @ Rated Torque	s	0.171	0.213	0.201	0.281
n5-02	Motor Inertia Acceleration Time	s	0.171	0.213	0.201	0.281
n8-49	Heavy Load Id Current	%	-15.8	-19.6	-14.9	-15.1

*1 The default setting changes when the setting for o2-04 [Drive Model Selection] changes.

Table 11.16 SSR1 Series Motor Code Setting for Specification of 200 V at 1150 min⁻¹ (r/min)

No.	Name	Unit	Motor Code (setting value of E5-01)							
E5-01	PM Motor Code Selection	-	1402	1403	1405	1406	1408	140A	140B	140D
	Voltage Class	V	200	200	200	200	200	200	200	200
	Capacity	kW	0.4	0.75	1.5	2.2	3.7	5.5	7.5	11
	Motor Rotation Speed	min ⁻¹	1150	1150	1150	1150	1150	1150	1150	1150
E5-02	PM Motor Rated Power	kW	0.4	0.75	1.5	2.2	3.7	5.5	7.5	11.0
E5-03	PM Motor Rated Current (FLA)	A	1.88	3.02	6.00	8.85	14.27	20.21	26.67	39.9
E5-04	PM Motor Pole Count	-	6	6	6	6	6	6	6	6
E5-05	PM Motor Resistance (ohms/phase)	Ω	4.832	2.704	1.114	0.511	0.412	0.303	0.165	0.113
E5-06	PM d-axis Inductance (mH/phase)	mH	48.68	32.31	19.22	12.15	7.94	11.13	6.59	4.96
E5-07	PM q-axis Inductance (mH/phase)	mH	63.21	40.24	24.38	15.35	11.86	14.06	8.55	6.12

11.22 Parameters Changed by PM Motor Code Selection

No.	Name	Unit	Motor Code (setting value of E5-01)							
E5-09	PM Back-EMF V _{peak} (mV/(rad/s))	mVs/rad	320.4	327.1	364.4	344.4	357.5	430.8	391.5	384.4
E5-24	PM Back-EMF L-L V _{rms} (mV/rpm)	mV/min ⁻¹	0.0	0.0	0.0	0.0	0.0	0.0	0.0	0.0
E1-04	Maximum Output Frequency	Hz	57.5	57.5	57.5	57.5	57.5	57.5	57.5	57.5
E1-05	Maximum Output Voltage	V	190.0	190.0	190.0	190.0	190.0	190.0	190.0	190.0
E1-06	Base Frequency	Hz	57.5	57.5	57.5	57.5	57.5	57.5	57.5	57.5
E1-09	Minimum Output Frequency	Hz	2.9	2.9	2.9	2.9	2.9	2.9	2.9	2.9
C5-17	Motor Inertia	kgm ²	0.0017	0.0023	0.0083	0.0136	0.0171	0.027	0.046	0.055
L3-24 *J	Motor Accel Time @ Rated Torque	s	0.062	0.044	0.080	0.090	0.067	0.072	0.088	0.073
n5-02	Motor Inertia Acceleration Time	s	0.062	0.044	0.080	0.090	0.067	0.072	0.088	0.073
n8-49	Heavy Load Id Current	%	-8.8	-9.9	-9.3	-10.0	-17.7	-12.3	-15.3	-13.9

*1 The default setting changes when the setting for o2-04 [Drive Model Selection] changes.

Table 11.17 SSR1 Series Motor Code Setting for Specification of 200 V at 1150 min⁻¹ (r/min)

No.	Name	Unit	Motor Code (setting value of E5-01)							
E5-01	PM Motor Code Selection	-	140E	140F	1410	1412	1413	1414		
	Voltage Class	V	200	200	200	200	200	200	200	
	Capacity	kW	15	18	22	30	37	45		
	Motor Rotation Speed	min ⁻¹	1150	1150	1150	1150	1150	1150	1150	
E5-02	PM Motor Rated Power	kW	15	18.50	22.00	30.00	37.00	45.00		
E5-03	PM Motor Rated Current (FLA)	A	55.6	63.5	74.4	104.2	129.6	154.2		
E5-04	PM Motor Pole Count	-	6	6	6	6	6	6		
E5-05	PM Motor Resistance (ohms/phase)	Ω	0.084	0.066	0.048	0.035	0.023	0.016		
E5-06	PM d-axis Inductance (mH/phase)	mH	3.83	3.33	2.38	2.04	1.53	1.16		
E5-07	PM q-axis Inductance (mH/phase)	mH	4.65	4.50	3.15	2.86	2.27	1.54		
E5-09	PM Back-EMF V _{peak} (mV/(rad/s))	mVs/rad	372.1	421.3	410.9	436.1	428.8	433.3		
E5-24	PM Back-EMF L-L V _{rms} (mV/rpm)	mV/min ⁻¹	0.0	0.0	0.0	0.0	0.0	0.0		
E1-04	Maximum Output Frequency	Hz	57.5	57.5	57.5	57.5	57.5	57.5		
E1-05	Maximum Output Voltage	V	190.0	190.0	190.0	190.0	190.0	190.0		
E1-06	Base Frequency	Hz	57.5	57.5	57.5	57.5	57.5	57.5		
E1-09	Minimum Output Frequency	Hz	2.9	2.9	2.9	2.9	2.9	2.9		
C5-17	Motor Inertia	kgm ²	0.064	0.116	0.140	0.259	0.312	0.418		
L3-24 *J	Motor Accel Time @ Rated Torque	s	0.062	0.091	0.092	0.125	0.122	0.135		
n5-02	Motor Inertia Acceleration Time	s	0.062	0.091	0.092	0.125	0.122	0.135		
n8-49	Heavy Load Id Current	%	-14.4	-17.9	-15.9	-17.9	-20.1	-13.7		

*1 The default setting changes when the setting for o2-04 [Drive Model Selection] changes.

Table 11.18 SSR1 Series Motor Code Setting for Specification of 400 V at 1150 min⁻¹ (r/min)

No.	Name	Unit	Motor Code (setting value of E5-01)							
			1432	1433	1435	1436	1438	143A	143B	143D
E5-01	PM Motor Code Selection	-	1432	1433	1435	1436	1438	143A	143B	143D
	Voltage Class	V	400	400	400	400	400	400	400	400
	Capacity	kW	0.4	0.75	1.5	2.2	3.7	5.5	7.5	11
	Motor Rotation Speed	min ⁻¹	1150	1150	1150	1150	1150	1150	1150	1150
E5-02	PM Motor Rated Power	kW	0.4	0.75	1.5	2.2	3.7	5.5	7.5	11.0
E5-03	PM Motor Rated Current (FLA)	A	0.94	1.51	3.00	4.43	7.08	10.10	13.33	19.9
E5-04	PM Motor Pole Count	-	6	6	6	6	6	6	6	6
E5-05	PM Motor Resistance (ohms/phase)	Ω	19.320	10.800	4.456	2.044	1.483	1.215	0.660	0.443
E5-06	PM d-axis Inductance (mH/phase)	mH	194.70	129.20	76.88	48.60	37.58	44.54	26.36	19.10
E5-07	PM q-axis Inductance (mH/phase)	mH	252.84	160.90	97.52	61.40	47.65	56.26	34.20	24.67
E5-09	PM Back-EMF V _{peak} (mV/(rad/s))	mVs/rad	640.9	654.1	728.8	688.9	702.0	861.5	783.0	762.2
E5-24	PM Back-EMF L-L V _{rms} (mV/rpm)	mV/min ⁻¹	0.0	0.0	0.0	0.0	0.0	0.0	0.0	0.0
E1-04	Maximum Output Frequency	Hz	57.5	57.5	57.5	57.5	57.5	57.5	57.5	57.5
E1-05	Maximum Output Voltage	V	380.0	380.0	380.0	380.0	380.0	380.0	380.0	380.0
E1-06	Base Frequency	Hz	57.5	57.5	57.5	57.5	57.5	57.5	57.5	57.5
E1-09	Minimum Output Frequency	Hz	2.9	2.9	2.9	2.9	2.9	2.9	2.9	2.9
C5-17	Motor Inertia	kgm ²	0.0017	0.0023	0.0083	0.0136	0.0171	0.027	0.046	0.055
L3-24 */	Motor Accel Time @ Rated Torque	s	0.062	0.044	0.080	0.090	0.067	0.072	0.088	0.073
n5-02	Motor Inertia Acceleration Time	s	0.062	0.044	0.080	0.090	0.067	0.072	0.088	0.073
n8-49	Heavy Load Id Current	%	-8.8	-9.9	-9.3	-10.0	-12.8	-12.3	-15.3	-16.7

*1 The default setting changes when the setting for o2-04 [Drive Model Selection] changes.

Table 11.19 SSR1 Series Motor Code Setting for Specification of 400 V at 1150 min⁻¹ (r/min)

No.	Name	Unit	Motor Code (setting value of E5-01)					
			143E	143F	1440	1442	1443	1444
E5-01	PM Motor Code Selection	-	143E	143F	1440	1442	1443	1444
	Voltage Class	V	400	400	400	400	400	400
	Capacity	kW	15	18	22	30	37	45
	Motor Rotation Speed	min ⁻¹	1150	1150	1150	1150	1150	1150
E5-02	PM Motor Rated Power	kW	15	18.50	22.00	30.00	37.00	45.00
E5-03	PM Motor Rated Current (FLA)	A	27.8	31.8	37.2	52.1	64.8	76.6
E5-04	PM Motor Pole Count	-	6	6	6	6	6	6
E5-05	PM Motor Resistance (ohms/phase)	Ω	0.331	0.264	0.192	0.140	0.093	0.063
E5-06	PM d-axis Inductance (mH/phase)	mH	15.09	13.32	9.52	8.16	6.13	4.63
E5-07	PM q-axis Inductance (mH/phase)	mH	18.56	18.00	12.60	11.40	9.10	6.15
E5-09	PM Back-EMF V _{peak} (mV/(rad/s))	mVs/rad	749.6	842.7	821.8	872.3	857.7	866.6
E5-24	PM Back-EMF L-L V _{rms} (mV/rpm)	mV/min ⁻¹	0.0	0.0	0.0	0.0	0.0	0.0

11.22 Parameters Changed by PM Motor Code Selection

No.	Name	Unit	Motor Code (setting value of E5-01)					
E1-04	Maximum Output Frequency	Hz	57.5	57.5	57.5	57.5	57.5	57.5
E1-05	Maximum Output Voltage	V	380.0	380.0	380.0	380.0	380.0	380.0
E1-06	Base Frequency	Hz	57.5	57.5	57.5	57.5	57.5	57.5
E1-09	Minimum Output Frequency	Hz	2.9	2.9	2.9	2.9	2.9	2.9
C5-17	Motor Inertia	kgm ²	0.064	0.116	0.140	0.259	0.312	0.418
L3-24 *J	Motor Accel Time @ Rated Torque	s	0.062	0.091	0.092	0.125	0.122	0.135
n5-02	Motor Inertia Acceleration Time	s	0.062	0.091	0.092	0.125	0.122	0.135
n8-49	Heavy Load Id Current	%	-14.9	-17.9	-15.9	-17.7	-20.1	-13.8

*1 The default setting changes when the setting for o2-04 [Drive Model Selection] changes.

Table 11.20 SSR1 Series Motor Code Setting for Specification of 400 V at 1150 min⁻¹ (r/min)

No.	Name	Unit	Motor Code (setting value of E5-01)			
E5-01	PM Motor Code Selection	-	1445	1446	1447	1448
	Voltage Class	V	400	400	400	400
	Capacity	kW	55	75	90	110
	Motor Rotation Speed	min ⁻¹	1150	1150	1150	1150
E5-02	PM Motor Rated Power	kW	55.00	75.00	90.00	110.00
E5-03	PM Motor Rated Current (FLA)	A	92.0	127.1	150.5	185.4
E5-04	PM Motor Pole Count	-	6	6	6	6
E5-05	PM Motor Resistance (ohms/phase)	Ω	0.051	0.033	0.027	0.015
E5-06	PM d-axis Inductance (mH/phase)	mH	3.96	3.03	2.60	1.89
E5-07	PM q-axis Inductance (mH/phase)	mH	5.00	5.14	3.28	2.33
E5-09	PM Back-EMF Vpeak (mV/(rad/s))	mVs/rad	854.0	823.1	853.4	829.2
E5-24	PM Back-EMF L-L Vrms (mV/rpm)	mV/min ⁻¹	0.0	0.0	0.0	0.0
E1-04	Maximum Output Frequency	Hz	57.5	57.5	57.5	57.5
E1-05	Maximum Output Voltage	V	380.0	380.0	380.0	380.0
E1-06	Base Frequency	Hz	57.5	57.5	57.5	57.5
E1-09	Minimum Output Frequency	Hz	2.9	2.9	2.9	2.9
C5-17	Motor Inertia	kgm ²	0.56	0.83	0.96	1.61
L3-24 *J	Motor Accel Time @ Rated Torque	s	0.147	0.161	0.154	0.212
n5-02	Motor Inertia Acceleration Time	s	0.147	0.161	0.154	0.212
n8-49	Heavy Load Id Current	%	-12.5	-28.8	-13.3	-11.6

*1 The default setting changes when the setting for o2-04 [Drive Model Selection] changes.

◆ Yaskawa SST4 Series IPM Motors (Constant Torque)

Table 11.21 SST4 series motor code setting for specification of 200 V at 1750 min⁻¹ (r/min)

No.	Name	Unit	Motor Code (setting value of E5-01)							
E5-01	PM Motor Code Selection	-	2202	2203	2205	2206	2208	220A	220B	220D
	Voltage Class	V	200	200	200	200	200	200	200	200
	Capacity	kW	0.4	0.75	1.5	2.2	3.7	5.5	7.5	11
	Motor Rotation Speed	min ⁻¹	1750	1750	1750	1750	1750	1750	1750	1750
E5-02	PM Motor Rated Power (kW)	kW	0.4	0.75	1.5	2.2	3.7	5.5	7.5	11.0
E5-03	PM Motor Rated Current (FLA)	A	1.77	3.54	6.56	8.96	14.79	20.94	29.58	41.1
E5-04	PM Motor Pole Count	-	6	6	6	6	6	6	6	6
E5-05	PM Motor Resistance (ohms/phase)	Ω	2.247	1.132	0.774	0.479	0.242	0.275	0.161	0.111
E5-06	PM d-axis Inductance (mH/phase)	mH	22.32	12.38	8.90	7.39	5.06	5.82	3.86	3.59
E5-07	PM q-axis Inductance (mH/phase)	mH	32.50	15.72	11.96	9.63	6.42	6.74	4.66	4.32
E5-09	PM Motor Induced Voltage Constant 1 (Ke)	mVs/rad	215.2	203.9	219.3	230.6	235.1	251.7	235.7	252.0
E5-24	PM Motor Induced Voltage Constant 2 (Ke)	mV/min ⁻¹	0.0	0.0	0.0	0.0	0.0	0.0	0.0	0.0
E1-04	Maximum Output Frequency	Hz	87.5	87.5	87.5	87.5	87.5	87.5	87.5	87.5
E1-05	Maximum Output Voltage	V	190.0	190.0	190.0	190.0	190.0	190.0	190.0	190.0
E1-06	Base Frequency	Hz	87.5	87.5	87.5	87.5	87.5	87.5	87.5	87.5
E1-09	Minimum Output Frequency	Hz	4.4	4.4	4.4	4.4	4.4	4.4	4.4	4.4
C5-17	Motor Inertia	kgm ²	0.0016	0.0022	0.0042	0.0081	0.0133	0.013	0.017	0.027
L3-24 */	Motor Accel Time for Inertia Cal	s	0.134	0.099	0.094	0.124	0.121	0.081	0.075	0.082
n5-02	Motor Inertia Acceleration Time	s	0.134	0.099	0.094	0.124	0.121	0.081	0.075	0.082
n8-49	d-Axis Cur forHighEfficiencyCont	%	-9.3	-6.4	-10.0	-9.9	-9.7	-8.4	-11.5	-13.1

*1 The default setting changes when the setting for o2-04 [Drive Model Selection] changes.

Table 11.22 SST4 series motor code setting for specification of 200 V at 1750 min⁻¹ (r/min)

No.	Name	Unit	Motor Code (setting value of E5-01)							
E5-01	PM Motor Code Selection	-	220E	220F	2210	2212	2213	2214	2215	2216
	Voltage Class	V	200	200	200	200	200	200	200	200
	Capacity	kW	15	18	22	30	37	45	55	75
	Motor Rotation Speed	min ⁻¹	1750	1750	1750	1750	1750	1750	1750	1750
E5-02	PM Motor Rated Power	kW	15	18.50	22.00	30.00	37.00	45.00	55.00	75.00
E5-03	PM Motor Rated Current (FLA)	A	54.2	68.2	78.6	104.2	129.2	153.1	205.2	260.4
E5-04	PM Motor Pole Count	-	6	6	6	6	6	6	6	6
E5-05	PM Motor Resistance (ohms/phase)	Ω	0.071	0.049	0.040	0.030	0.020	0.013	0.009	0.006
E5-06	PM d-axis Inductance (mH/phase)	mH	2.67	1.98	1.69	1.31	0.88	0.77	0.55	0.40
E5-07	PM q-axis Inductance (mH/phase)	mH	3.10	2.41	2.12	1.61	1.14	1.04	0.69	0.50

11.22 Parameters Changed by PM Motor Code Selection

No.	Name	Unit	Motor Code (setting value of E5-01)							
E5-09	PM Back-EMF V _{peak} (mV/(rad/s))	mVs/rad	253.7	244.6	256.3	283.1	266.3	260.0	261.5	259.3
E5-24	PM Back-EMF L-L V _{rms} (mV/rpm)	mV/min ⁻¹	0.0	0.0	0.0	0.0	0.0	0.0	0.0	0.0
E1-04	Maximum Output Frequency	Hz	87.5	87.5	87.5	87.5	87.5	87.5	87.5	87.5
E1-05	Maximum Output Voltage	V	190.0	190.0	190.0	190.0	190.0	190.0	190.0	190.0
E1-06	Base Frequency	Hz	87.5	87.5	87.5	87.5	87.5	87.5	87.5	87.5
E1-09	Minimum Output Frequency	Hz	4.4	4.4	4.4	4.4	4.4	4.4	4.4	4.4
C5-17	Motor Inertia	kgm ²	0.044	0.054	0.063	0.113	0.137	0.252	0.30	0.41
L3-24 *J	Motor Accel Time @ Rated Torque	s	0.099	0.098	0.096	0.126	0.124	0.188	0.186	0.184
n5-02	Motor Inertia Acceleration Time	s	0.099	0.098	0.096	0.126	0.124	0.188	0.186	0.184
n8-49	Heavy Load Id Current	%	-10.9	-14.3	-15.1	-11.3	-14.1	-18.8	-11.4	-12.2

*1 The default setting changes when the setting for o2-04 [Drive Model Selection] changes.

Table 11.23 SST4 Series Motor Code Setting for Specification of 400 V at 1750 min⁻¹ (r/min)

No.	Name	Unit	Motor Code (setting value of E5-01)							
E5-01	PM Motor Code Selection	-	2232	2233	2235	2236	2238	223A	223B	223D
	Voltage Class	V	400	400	400	400	400	400	400	400
	Capacity	kW	0.4	0.75	1.5	2.2	3.7	5.5	7.5	11
	Motor Rotation Speed	min ⁻¹	1750	1750	1750	1750	1750	1750	1750	1750
E5-02	PM Motor Rated Power	kW	0.4	0.75	1.5	2.2	3.7	5.5	7.5	11.0
E5-03	PM Motor Rated Current (FLA)	A	0.92	1.77	3.33	4.48	7.50	10.42	14.27	20.5
E5-04	PM Motor Pole Count	-	6	6	6	6	6	6	6	6
E5-05	PM Motor Resistance (ohms/phase)	Ω	8.935	4.570	3.096	1.906	0.972	1.103	0.630	0.429
E5-06	PM d-axis Inductance (mH/phase)	mH	80.14	48.04	35.60	30.31	20.03	23.41	14.86	14.34
E5-07	PM q-axis Inductance (mH/phase)	mH	110.76	64.88	47.84	38.36	24.97	28.70	17.25	17.25
E5-09	PM Back-EMF V _{peak} (mV/(rad/s))	mVs/rad	416.5	399.4	438.5	475.5	463.7	485.8	470.4	513.4
E5-24	PM Back-EMF L-L V _{rms} (mV/rpm)	mV/min ⁻¹	0.0	0.0	0.0	0.0	0.0	0.0	0.0	0.0
E1-04	Maximum Output Frequency	Hz	87.5	87.5	87.5	87.5	87.5	87.5	87.5	87.5
E1-05	Maximum Output Voltage	V	380.0	380.0	380.0	380.0	380.0	380.0	380.0	380.0
E1-06	Base Frequency	Hz	87.5	87.5	87.5	87.5	87.5	87.5	87.5	87.5
E1-09	Minimum Output Frequency	Hz	4.4	4.4	4.4	4.4	4.4	4.4	4.4	4.4
C5-17	Motor Inertia	kgm ²	0.0016	0.0022	0.0042	0.0081	0.0133	0.013	0.017	0.027
L3-24 *J	Motor Accel Time @ Rated Torque	s	0.134	0.099	0.094	0.124	0.121	0.081	0.075	0.082
n5-02	Motor Inertia Acceleration Time	s	0.134	0.099	0.094	0.124	0.121	0.081	0.075	0.082
n8-49	Heavy Load Id Current	%	-7.5	-8.5	-9.8	-8.2	-9.1	-13.1	-9.2	-12.4

*1 The default setting changes when the setting for o2-04 [Drive Model Selection] changes.

Table 11.24 SST4 Series Motor Code Setting for Specification of 400 V at 1750 min⁻¹ (r/min)

No.	Name	Unit	Motor Code (setting value of E5-01)							
E5-01	PM Motor Code Selection	-	223E	223F	2240	2242	2243	2244	2245	2246
	Voltage Class	V	400	400	400	400	400	400	400	400
	Capacity	kW	15	18	22	30	37	45	55	75
	Motor Rotation Speed	min ⁻¹	1750	1750	1750	1750	1750	1750	1750	1750
E5-02	PM Motor Rated Power	kW	15	18.50	22.00	30.00	37.00	45.00	55.00	75.00
E5-03	PM Motor Rated Current (FLA)	A	26.4	34.2	38.8	52.2	65.4	77.6	99.3	130.2
E5-04	PM Motor Pole Count	-	6	6	6	6	6	6	6	6
E5-05	PM Motor Resistance (ohms/phase)	Ω	0.275	0.196	0.160	0.120	0.077	0.052	0.036	0.023
E5-06	PM d-axis Inductance (mH/phase)	mH	9.99	7.92	6.82	5.24	3.57	2.98	1.59	1.59
E5-07	PM q-axis Inductance (mH/phase)	mH	12.37	9.64	8.51	6.44	4.65	3.75	2.78	1.97
E5-09	PM Back-EMF V _{peak} (mV/(rad/s))	mVs/rad	505.3	489.2	509.5	566.2	531.6	530.6	515.2	515.2
E5-24	PM Back-EMF L-L V _{rms} (mV/rpm)	mV/min ⁻¹	0.0	0.0	0.0	0.0	0.0	0.0	0.0	0.0
E1-04	Maximum Output Frequency	Hz	87.5	87.5	87.5	87.5	87.5	87.5	87.5	87.5
E1-05	Maximum Output Voltage	V	380.0	380.0	380.0	380.0	380.0	380.0	380.0	380.0
E1-06	Base Frequency	Hz	87.5	87.5	87.5	87.5	87.5	87.5	87.5	87.5
E1-09	Minimum Output Frequency	Hz	4.4	4.4	4.4	4.4	4.4	4.4	4.4	4.4
C5-17	Motor Inertia	kgm ²	0.044	0.054	0.063	0.113	0.137	0.252	0.30	0.41
L3-24 */	Motor Accel Time @ Rated Torque	s	0.099	0.098	0.096	0.126	0.124	0.188	0.186	0.184
n5-02	Motor Inertia Acceleration Time	s	0.099	0.098	0.096	0.126	0.124	0.188	0.186	0.184
n8-49	Heavy Load Id Current	%	-15.1	-14.3	-15.3	-11.3	-14.5	-13.2	-22.6	-11.9

*1 The default setting changes when the setting for o2-04 [Drive Model Selection] changes.

Table 11.25 SST4 Series Motor Code Setting for Specification of 400 V at 1750 min⁻¹ (r/min)

No.	Name	Unit	Motor Code (setting value of E5-01)							
E5-01	PM Motor Code Selection	-	2247	2248	2249	224A	224C	224D	224E	
	Voltage Class	V	400	400	400	400	400	400	400	
	Capacity	kW	90	110	132	160	200	220	300	
	Motor Rotation Speed	min ⁻¹	1750	1750	1750	1750	1750	1750	1750	
E5-02	PM Motor Rated Power	kW	90.00	110.00	132.00	160.00	200.00	250.00	300.00	
E5-03	PM Motor Rated Current (FLA)	A	153.1	184.4	229.2	269.8	346.9	421.9	520.8	
E5-04	PM Motor Pole Count	-	6	6	6	6	6	6	6	
E5-05	PM Motor Resistance (ohms/phase)	Ω	0.019	0.017	0.012	0.008	0.005	0.004	0.002	
E5-06	PM d-axis Inductance (mH/phase)	mH	1.51	1.43	1.13	0.96	0.65	0.67	0.40	
E5-07	PM q-axis Inductance (mH/phase)	mH	1.76	1.92	1.54	1.26	0.88	0.74	0.52	
E5-09	PM Back-EMF V _{peak} (mV/(rad/s))	mVs/rad	538.3	590.9	548.2	603.9	556.8	593.1	495.4	
E5-24	PM Back-EMF L-L V _{rms} (mV/rpm)	mV/min ⁻¹	0.0	0.0	0.0	0.0	0.0	0.0	0.0	

11.22 Parameters Changed by PM Motor Code Selection

No.	Name	Unit	Motor Code (setting value of E5-01)						
E1-04	Maximum Output Frequency	Hz	87.5	87.5	87.5	87.5	87.5	87.5	87.5
E1-05	Maximum Output Voltage	V	380.0	380.0	380.0	380.0	380.0	380.0	380.0
E1-06	Base Frequency	Hz	87.5	87.5	87.5	87.5	87.5	87.5	87.5
E1-09	Minimum Output Frequency	Hz	4.4	4.4	4.4	4.4	4.4	4.4	4.4
C5-17	Motor Inertia	kgm ²	0.55	0.82	0.96	1.60	1.95	2.82	3.70
L3-24 */	Motor Accel Time @ Rated Torque	s	0.205	0.250	0.244	0.336	0.327	0.379	0.414
n5-02	Motor Inertia Acceleration Time	s	0.205	0.250	0.244	0.336	0.327	0.379	0.414
n8-49	Heavy Load Id Current	%	-8.6	-14.8	-17.5	-12.5	-14.7	-5.1	-16.3

*1 The default setting changes when the setting for o2-04 [Drive Model Selection] changes.

Table 11.26 SST4 Series Motor Code Setting for Specification of 200 V at 1450 min⁻¹ (r/min)

No.	Name	Unit	Motor Code (setting value of E5-01)							
E5-01	PM Motor Code Selection	-	2302	2303	2305	2306	2308	230A	230B	230D
	Voltage Class	V	200	200	200	200	200	200	200	200
	Capacity	kW	0.4	0.75	1.5	2.2	3.7	5.5	7.5	11
	Motor Rotation Speed	min ⁻¹	1450	1450	1450	1450	1450	1450	1450	1450
E5-02	PM Motor Rated Power	kW	0.4	0.75	1.5	2.2	3.7	5.5	7.5	11.0
E5-03	PM Motor Rated Current (FLA)	A	1.77	3.33	5.94	9.48	14.17	20.42	27.92	39.6
E5-04	PM Motor Pole Count	-	6	6	6	6	6	6	6	6
E5-05	PM Motor Resistance (ohms/phase)	Ω	3.154	1.835	0.681	0.308	0.405	0.278	0.180	0.098
E5-06	PM d-axis Inductance (mH/phase)	mH	28.46	19.46	10.00	6.88	8.15	5.77	6.32	3.34
E5-07	PM q-axis Inductance (mH/phase)	mH	39.29	25.89	15.20	9.25	10.76	8.60	8.80	4.61
E5-09	PM Back-EMF V _{peak} (mV/(rad/s))	mVs/rad	268.8	256.9	271.9	260.2	286.8	314.9	300.8	292.3
E5-24	PM Back-EMF L-L V _{rms} (mV/rpm)	mV/min ⁻¹	0.0	0.0	0.0	0.0	0.0	0.0	0.0	0.0
E1-04	Maximum Output Frequency	Hz	72.5	72.5	72.5	72.5	72.5	72.5	72.5	72.5
E1-05	Maximum Output Voltage	V	190.0	190.0	190.0	190.0	190.0	190.0	190.0	190.0
E1-06	Base Frequency	Hz	72.5	72.5	72.5	72.5	72.5	72.5	72.5	72.5
E1-09	Minimum Output Frequency	Hz	3.6	3.6	3.6	3.6	3.6	3.6	3.6	3.6
C5-17	Motor Inertia	kgm ²	0.0016	0.0022	0.0081	0.0133	0.0133	0.017	0.027	0.044
L3-24 */	Motor Accel Time @ Rated Torque	s	0.092	0.068	0.125	0.139	0.083	0.070	0.082	0.092
n5-02	Motor Inertia Acceleration Time	s	0.092	0.068	0.125	0.139	0.083	0.070	0.082	0.092
n8-49	Heavy Load Id Current	%	-7.5	-9.4	-13.9	-10.0	-15.0	-17.9	-22.7	-20.5

*1 The default setting changes when the setting for o2-04 [Drive Model Selection] changes.

Table 11.27 SST4 Series Motor Code Setting for Specification of 200 V at 1450 min⁻¹ (r/min)

No.	Name	Unit	Motor Code (setting value of E5-01)							
			230E	230F	2310	2312	2313	2314	2315	2316
E5-01	PM Motor Code Selection	-	230E	230F	2310	2312	2313	2314	2315	2316
	Voltage Class	V	200	200	200	200	200	200	200	200
	Capacity	kW	15	18	22	30	37	45	55	75
	Motor Rotation Speed	min ⁻¹	1450	1450	1450	1450	1450	1450	1450	1450
E5-02	PM Motor Rated Power	kW	15.0	18.50	22.00	30.00	37.00	45.00	55.00	75.00
E5-03	PM Motor Rated Current (FLA)	A	54.2	68.3	75.2	102.0	131.3	160.4	191.7	257.3
E5-04	PM Motor Pole Count	-	6	6	6	6	6	6	6	6
E5-05	PM Motor Resistance (ohms/phase)	Ω	0.073	0.055	0.048	0.034	0.023	0.016	0.012	0.007
E5-06	PM d-axis Inductance (mH/phase)	mH	2.94	2.23	2.08	1.67	1.39	0.94	0.82	0.56
E5-07	PM q-axis Inductance (mH/phase)	mH	3.65	2.85	2.66	2.04	1.73	1.22	1.06	0.76
E5-09	PM Back-EMF V _{peak} (mV/(rad/s))	mVs/rad	305.1	297.6	355.8	355.4	324.0	302.4	337.2	323.4
E5-24	PM Back-EMF L-L V _{rms} (mV/rpm)	mV/min ⁻¹	0.0	0.0	0.0	0.0	0.0	0.0	0.0	0.0
E1-04	Maximum Output Frequency	Hz	72.5	72.5	72.5	72.5	72.5	72.5	72.5	72.5
E1-05	Maximum Output Voltage	V	190.0	190.0	190.0	190.0	190.0	190.0	190.0	190.0
E1-06	Base Frequency	Hz	72.5	72.5	72.5	72.5	72.5	72.5	72.5	72.5
E1-09	Minimum Output Frequency	Hz	3.6	3.6	3.6	3.6	3.6	3.6	3.6	3.6
C5-17	Motor Inertia	kgm ²	0.054	0.063	0.113	0.137	0.252	0.304	0.41	0.55
L3-24 */	Motor Accel Time @ Rated Torque	s	0.083	0.079	0.118	0.105	0.157	0.156	0.172	0.169
n5-02	Motor Inertia Acceleration Time	s	0.083	0.079	0.118	0.105	0.157	0.156	0.172	0.169
n8-49	Heavy Load Id Current	%	-14.6	-16.4	-11.8	-10.5	-14.5	-17.4	-13.8	-17.5

*1 The default setting changes when the setting for o2-04 [Drive Model Selection] changes.

Table 11.28 SST4 Series Motor Code Setting for Specification of 400 V at 1450 min⁻¹ (r/min)

No.	Name	Unit	Motor Code (setting value of E5-01)							
			2332	2333	2335	2336	2338	233A	233B	233D
E5-01	PM Motor Code Selection	-	2332	2333	2335	2336	2338	233A	233B	233D
	Voltage Class	V	400	400	400	400	400	400	400	400
	Capacity	kW	0.4	0.75	1.5	2.2	3.7	5.5	7.5	11
	Motor Rotation Speed	min ⁻¹	1450	1450	1450	1450	1450	1450	1450	1450
E5-02	PM Motor Rated Power	kW	0.4	0.75	1.5	2.2	3.7	5.5	7.5	11.0
E5-03	PM Motor Rated Current (FLA)	A	0.91	1.67	3.02	4.74	7.08	10.21	13.96	20.5
E5-04	PM Motor Pole Count	-	6	6	6	6	6	6	6	6
E5-05	PM Motor Resistance (ohms/phase)	Ω	12.616	7.340	2.724	1.232	1.509	1.112	0.720	0.393
E5-06	PM d-axis Inductance (mH/phase)	mH	113.84	77.84	40.00	27.52	31.73	23.09	25.28	13.36
E5-07	PM q-axis Inductance (mH/phase)	mH	157.16	103.56	60.80	37.00	40.88	34.39	35.20	18.44
E5-09	PM Back-EMF V _{peak} (mV/(rad/s))	mVs/rad	490.8	513.8	543.7	520.3	580.8	602.7	601.5	584.6

11.22 Parameters Changed by PM Motor Code Selection

No.	Name	Unit	Motor Code (setting value of E5-01)							
E5-24	PM Back-EMF L-L Vrms (mV/rpm)	mV/min ⁻¹	0.0	0.0	0.0	0.0	0.0	0.0	0.0	0.0
E1-04	Maximum Output Frequency	Hz	72.5	72.5	72.5	72.5	72.5	72.5	72.5	72.5
E1-05	Maximum Output Voltage	V	380.0	380.0	380.0	380.0	380.0	380.0	380.0	380.0
E1-06	Base Frequency	Hz	72.5	72.5	72.5	72.5	72.5	72.5	72.5	72.5
E1-09	Minimum Output Frequency	Hz	3.6	3.6	3.6	3.6	3.6	3.6	3.6	3.6
C5-17	Motor Inertia	kgm ²	0.0016	0.0022	0.0081	0.0133	0.0133	0.017	0.027	0.044
L3-24 *J	Motor Accel Time @ Rated Torque	s	0.092	0.068	0.125	0.139	0.083	0.070	0.082	0.092
n5-02	Motor Inertia Acceleration Time	s	0.092	0.068	0.125	0.139	0.083	0.070	0.082	0.092
n8-49	Heavy Load Id Current	%	-9.5	-9.4	-13.7	-10.0	-12.9	-19.9	-22.8	-19.8

*1 The default setting changes when the setting for o2-04 [Drive Model Selection] changes.

Table 11.29 SST4 Series Motor Code Setting for Specification of 400 V at 1450 min⁻¹ (r/min)

No.	Name	Unit	Motor Code (setting value of E5-01)							
E5-01	PM Motor Code Selection	-	233E	233F	2340	2342	2343	2344	2345	2346
	Voltage Class	V	400	400	400	400	400	400	400	400
	Capacity	kW	15	18	22	30	37	45	55	75
	Motor Rotation Speed	min ⁻¹	1450	1450	1450	1450	1450	1450	1450	1450
E5-02	PM Motor Rated Power	kW	15	18.50	22.00	30.00	37.00	45.00	55.00	75.00
E5-03	PM Motor Rated Current (FLA)	A	27.1	34.2	37.6	50.9	65.4	80.2	96.1	129.2
E5-04	PM Motor Pole Count	-	6	6	6	6	6	6	6	6
E5-05	PM Motor Resistance (ohms/phase)	Ω	0.291	0.220	0.192	0.136	0.091	0.064	0.048	0.028
E5-06	PM d-axis Inductance (mH/phase)	mH	11.77	8.94	8.32	6.68	5.30	3.76	3.09	2.24
E5-07	PM q-axis Inductance (mH/phase)	mH	14.60	11.40	10.64	8.16	6.80	4.88	4.75	3.03
E5-09	PM Back-EMF Vpeak (mV/(rad/s))	mVs/rad	610.3	595.2	711.6	710.8	652.7	604.8	669.1	646.8
E5-24	PM Back-EMF L-L Vrms (mV/rpm)	mV/min ⁻¹	0.0	0.0	0.0	0.0	0.0	0.0	0.0	0.0
E1-04	Maximum Output Frequency	Hz	72.5	72.5	72.5	72.5	72.5	72.5	72.5	72.5
E1-05	Maximum Output Voltage	V	380.0	380.0	380.0	380.0	380.0	380.0	380.0	380.0
E1-06	Base Frequency	Hz	72.5	72.5	72.5	72.5	72.5	72.5	72.5	72.5
E1-09	Minimum Output Frequency	Hz	3.6	3.6	3.6	3.6	3.6	3.6	3.6	3.6
C5-17	Motor Inertia	kgm ²	0.054	0.063	0.113	0.137	0.252	0.304	0.41	0.55
L3-24 *J	Motor Accel Time @ Rated Torque	s	0.083	0.079	0.118	0.105	0.157	0.156	0.172	0.169
n5-02	Motor Inertia Acceleration Time	s	0.083	0.079	0.118	0.105	0.157	0.156	0.172	0.169
n8-49	Heavy Load Id Current	%	-14.5	-16.1	-11.8	-10.5	-15.6	-17.4	-21.7	-17.3

*1 The default setting changes when the setting for o2-04 [Drive Model Selection] changes.

Table 11.30 SST4 Series Motor Code Setting for Specification of 400 V at 1450 min⁻¹ (r/min)

No.	Name	Unit	Motor Code (setting value of E5-01)					
E5-01	PM Motor Code Selection	-	2347	2348	2349	234A	234C	234D
	Voltage Class	V	400	400	400	400	400	400
	Capacity	kW	90	110	132	160	200	250
	Motor Rotation Speed	min ⁻¹	1450	1450	1450	1450	1450	1450
E5-02	PM Motor Rated Power	kW	90.00	110.00	132.00	160.00	200.00	250.00
E5-03	PM Motor Rated Current (FLA)	A	153.1	191.7	226.0	268.8	331.3	422.9
E5-04	PM Motor Pole Count	-	6	6	6	6	6	6
E5-05	PM Motor Resistance (ohms/phase)	Ω	0.024	0.015	0.011	0.007	0.006	0.003
E5-06	PM d-axis Inductance (mH/phase)	mH	2.20	1.34	1.23	0.92	0.84	0.61
E5-07	PM q-axis Inductance (mH/phase)	mH	3.23	2.16	1.67	1.30	1.25	0.89
E5-09	PM Back-EMF V _{peak} (mV/(rad/s))	mVs/rad	708.0	637.8	677.0	661.7	687.1	655.9
E5-24	PM Back-EMF L-L V _{rms} (mV/rpm)	mV/min ⁻¹	0.0	0.0	0.0	0.0	0	0.0
E1-04	Maximum Output Frequency	Hz	72.5	72.5	72.5	72.5	72.5	72.5
E1-05	Maximum Output Voltage	V	380.0	380.0	380.0	380.0	380.0	380.0
E1-06	Base Frequency	Hz	72.5	72.5	72.5	72.5	72.5	72.5
E1-09	Minimum Output Frequency	Hz	3.6	3.6	3.6	3.6	3.6	3.6
C5-17	Motor Inertia	kgm ²	0.82	0.96	1.60	1.95	2.82	3.70
L3-24 */	Motor Accel Time @ Rated Torque	s	0.210	0.201	0.279	0.281	0.325	0.341
n5-02	Motor Inertia Acceleration Time	s	0.210	0.201	0.279	0.281	0.325	0.341
n8-49	Heavy Load Id Current	%	-19.6	-24.1	-15.1	-17.0	-19.8	-19.3

*1 The default setting changes when the setting for o2-04 [Drive Model Selection] changes.

Table 11.31 SST4 Series Motor Code Setting for Specification of 200 V at 1150 min⁻¹ (r/min)

No.	Name	Unit	Motor Code (setting value of E5-01)							
E5-01	PM Motor Code Selection	-	2402	2403	2405	2406	2408	240A	240B	240D
	Voltage Class	V	200	200	200	200	200	200	200	200
	Capacity	kW	0.4	0.75	1.5	2.2	3.7	5.5	7.5	11
	Motor Rotation Speed	min ⁻¹	1150	1150	1150	1150	1150	1150	1150	1150
E5-02	PM Motor Rated Power	kW	0.4	0.75	1.5	2.2	3.7	5.5	7.5	11.0
E5-03	PM Motor Rated Current (FLA)	A	1.77	3.44	5.94	9.17	14.79	20.21	27.40	39.0
E5-04	PM Motor Pole Count	-	6	6	6	6	6	6	6	6
E5-05	PM Motor Resistance (ohms/phase)	Ω	2.680	1.520	1.071	0.542	0.362	0.295	0.162	0.115
E5-06	PM d-axis Inductance (mH/phase)	mH	30.55	15.29	17.48	11.98	8.60	9.54	5.31	4.44
E5-07	PM q-axis Inductance (mH/phase)	mH	42.71	24.28	22.51	15.51	10.69	13.84	8.26	5.68
E5-09	PM Back-EMF V _{peak} (mV/(rad/s))	mVs/rad	313.1	313.1	345.3	342.9	363.8	384.3	379.9	370.2

11.22 Parameters Changed by PM Motor Code Selection

No.	Name	Unit	Motor Code (setting value of E5-01)							
E5-24	PM Back-EMF L-L Vrms (mV/rpm)	mV/min ⁻¹	0.0	0.0	0.0	0.0	0.0	0.0	0.0	0.0
E1-04	Maximum Output Frequency	Hz	57.5	57.5	57.5	57.5	57.5	57.5	57.5	57.5
E1-05	Maximum Output Voltage	V	190.0	190.0	190.0	190.0	190.0	190.0	190.0	190.0
E1-06	Base Frequency	Hz	57.5	57.5	57.5	57.5	57.5	57.5	57.5	57.5
E1-09	Minimum Output Frequency	Hz	2.9	2.9	2.9	2.9	2.9	2.9	2.9	2.9
C5-17	Motor Inertia	kgm ²	0.0022	0.0042	0.0081	0.0133	0.0168	0.027	0.044	0.054
L3-24 *J	Motor Accel Time @ Rated Torque	s	0.080	0.081	0.078	0.088	0.066	0.070	0.085	0.071
n5-02	Motor Inertia Acceleration Time	s	0.080	0.081	0.078	0.088	0.066	0.070	0.085	0.071
n8-49	Heavy Load Id Current	%	-8.4	-11.0	-10.7	-10.7	-9.4	-22.5	-22.2	-16.7

*1 The default setting changes when the setting for o2-04 [Drive Model Selection] changes.

Table 11.32 SST4 Series Motor Code Setting for Specification of 200 V at 1150 min⁻¹ (r/min)

No.	Name	Unit	Motor Code (setting value of E5-01)							
E5-01	PM Motor Code Selection	-	240E	240F	2410	2412	2413	2414	2415	2416
	Voltage Class	V	200	200	200	200	200	200	200	200
	Capacity	kW	15	18	22	30	37	45	55	75
	Motor Rotation Speed	min ⁻¹	1150	1150	1150	1150	1150	1150	1150	1150
E5-02	PM Motor Rated Power	kW	15	18.50	22.00	30.00	37.00	45.00	55.00	75.00
E5-03	PM Motor Rated Current (FLA)	A	55.9	65.4	77.0	103.5	126.0	153.1	188.5	260.4
E5-04	PM Motor Pole Count	-	6	6	6	6	6	6	6	6
E5-05	PM Motor Resistance (ohms/phase)	Ω	0.083	0.065	0.052	0.035	0.026	0.019	0.013	0.009
E5-06	PM d-axis Inductance (mH/phase)	mH	3.50	2.92	2.55	2.03	1.59	1.24	0.98	0.70
E5-07	PM q-axis Inductance (mH/phase)	mH	4.23	3.79	3.22	2.46	1.92	1.64	1.37	0.97
E5-09	PM Back-EMF Vpeak (mV/(rad/s))	mVs/rad	364.5	404.5	445.1	444.4	447.3	470.8	422.4	418.3
E5-24	PM Back-EMF L-L Vrms (mV/rpm)	mV/min ⁻¹	0.0	0.0	0.0	0.0	0.0	0.0	0.0	0.0
E1-04	Maximum Output Frequency	Hz	57.5	57.5	57.5	57.5	57.5	57.5	57.5	57.5
E1-05	Maximum Output Voltage	V	190.0	190.0	190.0	190.0	190.0	190.0	190.0	190.0
E1-06	Base Frequency	Hz	57.5	57.5	57.5	57.5	57.5	57.5	57.5	57.5
E1-09	Minimum Output Frequency	Hz	2.9	2.9	2.9	2.9	2.9	2.9	2.9	2.9
C5-17	Motor Inertia	kgm ²	0.063	0.113	0.137	0.252	0.304	0.410	0.55	0.82
L3-24 *J	Motor Accel Time @ Rated Torque	s	0.061	0.089	0.090	0.122	0.119	0.132	0.145	0.159
n5-02	Motor Inertia Acceleration Time	s	0.061	0.089	0.090	0.122	0.119	0.132	0.145	0.159
n8-49	Heavy Load Id Current	%	-13.7	-15.2	-10.9	-9.8	-9.3	-11.5	-17.7	-17.1

*1 The default setting changes when the setting for o2-04 [Drive Model Selection] changes.

Table 11.33 SST4 Series Motor Code Setting for Specification of 400 V at 1150 min⁻¹ (r/min)

No.	Name	Unit	Motor Code (setting value of E5-01)						
E5-01	PM Motor Code Selection	-	2432	2433	2435	2436	2438	243A	243B
	Voltage Class	V	400	400	400	400	400	400	400
	Capacity	kW	0.4	0.75	1.5	2.2	3.7	5.5	7.5
	Motor Rotation Speed	min ⁻¹	1150	1150	1150	1150	1150	1150	1150
E5-02	PM Motor Rated Power	kW	0.4	0.75	1.5	2.2	3.7	5.5	7.5
E5-03	PM Motor Rated Current (FLA)	A	0.89	1.72	3.02	4.58	7.40	10.21	13.75
E5-04	PM Motor Pole Count	-	6	6	6	6	6	6	6
E5-05	PM Motor Resistance (ohms/phase)	Ω	10.720	6.080	4.336	2.143	1.428	1.199	0.648
E5-06	PM d-axis Inductance (mH/phase)	mH	122.20	61.16	70.24	46.20	33.87	41.67	21.24
E5-07	PM q-axis Inductance (mH/phase)	mH	170.80	97.12	90.04	60.28	42.98	69.15	33.04
E5-09	PM Back-EMF V _{peak} (mV/(rad/s))	mVs/rad	626.1	626.1	703.1	727.6	699.0	861.5	759.7
E5-24	PM Back-EMF L-L V _{rms} (mV/rpm)	mV/min ⁻¹	0.0	0.0	0.0	0.0	0.0	0.0	0.0
E1-04	Maximum Output Frequency	Hz	57.5	57.5	57.5	57.5	57.5	57.5	57.5
E1-05	Maximum Output Voltage	V	380.0	380.0	380.0	380.0	380.0	380.0	380.0
E1-06	Base Frequency	Hz	57.5	57.5	57.5	57.5	57.5	57.5	57.5
E1-09	Minimum Output Frequency	Hz	2.9	2.9	2.9	2.9	2.9	2.9	2.9
C5-17	Motor Inertia	kgm ²	0.0022	0.0042	0.0081	0.0133	0.0168	0.027	0.044
L3-24 */	Motor Accel Time @ Rated Torque	s	0.080	0.081	0.078	0.088	0.066	0.070	0.085
n5-02	Motor Inertia Acceleration Time	s	0.080	0.081	0.078	0.088	0.066	0.070	0.085
n8-49	Heavy Load Id Current	%	-8.4	-11.0	-9.9	-9.0	-11.4	-23.2	-22.1

*1 The default setting changes when the setting for o2-04 [Drive Model Selection] changes.

Table 11.34 SST4 Series Motor Code Setting for Specification of 400 V at 1150 min⁻¹ (r/min)

No.	Name	Unit	Motor Code (setting value of E5-01)						
E5-01	PM Motor Code Selection	-	243D	243E	243F	2440	2442	2443	2444
	Voltage Class	V	400	400	400	400	400	400	400
	Capacity	kW	11	15	18	22	30	37	45
	Motor Rotation Speed	min ⁻¹	1150	1150	1150	1150	1150	1150	1150
E5-02	PM Motor Rated Power	kW	11.0	15	18.50	22.00	30.00	37.00	45.00
E5-03	PM Motor Rated Current (FLA)	A	19.5	27.7	32.7	39.2	51.8	63.0	76.6
E5-04	PM Motor Pole Count	-	6	6	6	6	6	6	6
E5-05	PM Motor Resistance (ohms/phase)	Ω	0.460	0.325	0.260	0.209	0.140	0.106	0.076
E5-06	PM d-axis Inductance (mH/phase)	mH	17.76	12.83	11.68	10.09	8.12	6.43	4.96
E5-07	PM q-axis Inductance (mH/phase)	mH	22.72	17.19	15.16	16.25	9.84	7.71	6.56
E5-09	PM Back-EMF V _{peak} (mV/(rad/s))	mVs/rad	740.4	716.6	809.1	786.2	888.8	857.7	941.6

11.22 Parameters Changed by PM Motor Code Selection

No.	Name	Unit	Motor Code (setting value of E5-01)						
E5-24	PM Back-EMF L-L Vrms (mV/rpm)	mV/min ⁻¹	0.0	0.0	0.0	0.0	0.0	0.0	0.0
E1-04	Maximum Output Frequency	Hz	57.5	57.5	57.5	57.5	57.5	57.5	57.5
E1-05	Maximum Output Voltage	V	380.0	380.0	380.0	380.0	380.0	380.0	380.0
E1-06	Base Frequency	Hz	57.5	57.5	57.5	57.5	57.5	57.5	57.5
E1-09	Minimum Output Frequency	Hz	2.9	2.9	2.9	2.9	2.9	2.9	2.9
C5-17	Motor Inertia	kgm ²	0.054	0.063	0.113	0.137	0.252	0.304	0.410
L3-24 *J	Motor Accel Time @ Rated Torque	s	0.071	0.061	0.089	0.090	0.122	0.119	0.132
n5-02	Motor Inertia Acceleration Time	s	0.071	0.061	0.089	0.090	0.122	0.119	0.132
n8-49	Heavy Load Id Current	%	-16.7	-20.2	-15.2	-27.7	-9.8	-10.2	-11.5

*1 The default setting changes when the setting for o2-04 [Drive Model Selection] changes.

Table 11.35 SST4 Series Motor Code Setting for Specification of 400 V at 1150 min⁻¹ (r/min)

No.	Name	Unit	Motor Code (setting value of E5-01)						
E5-01	PM Motor Code Selection	-	2445	2446	2447	2448	2449	244A	244C
	Voltage Class	V	400	400	400	400	400	400	400
	Capacity	kW	55	75	90	110	132	160	200
	Motor Rotation Speed	min ⁻¹	1150	1150	1150	1150	1150	1150	1150
E5-02	PM Motor Rated Power	kW	55.00	75.00	90.00	110.00	132.00	160.00	200.00
E5-03	PM Motor Rated Current (FLA)	A	93.1	128.1	153.1	186.5	221.9	269.8	336.5
E5-04	PM Motor Pole Count	-	6	6	6	6	6	6	6
E5-05	PM Motor Resistance (ohms/phase)	Ω	0.051	0.032	0.026	0.015	0.012	0.009	0.007
E5-06	PM d-axis Inductance (mH/phase)	mH	3.99	2.97	2.44	1.87	1.49	1.41	1.22
E5-07	PM q-axis Inductance (mH/phase)	mH	5.39	3.90	3.23	2.46	2.08	1.88	1.51
E5-09	PM Back-EMF Vpeak (mV/(rad/s))	mVs/rad	853.8	829.6	835.6	833.4	848.6	889.1	915.0
E5-24	PM Back-EMF L-L Vrms (mV/rpm)	mV/min ⁻¹	0.0	0.0	0.0	0.0	0.0	0.0	0.0
E1-04	Maximum Output Frequency	Hz	57.5	57.5	57.5	57.5	57.5	57.5	57.5
E1-05	Maximum Output Voltage	V	380.0	380.0	380.0	380.0	380.0	380.0	380.0
E1-06	Base Frequency	Hz	57.5	57.5	57.5	57.5	57.5	57.5	57.5
E1-09	Minimum Output Frequency	Hz	2.9	2.9	2.9	2.9	2.9	2.9	2.9
C5-17	Motor Inertia	kgm ²	0.55	0.82	0.96	1.60	1.95	2.82	3.70
L3-24 *J	Motor Accel Time @ Rated Torque	s	0.145	0.159	0.155	0.211	0.214	0.256	0.268
n5-02	Motor Inertia Acceleration Time	s	0.145	0.159	0.155	0.211	0.214	0.256	0.268
n8-49	Heavy Load Id Current	%	-15.9	-15.7	-15.7	-14.7	-16.5	-14.1	-10.3

*1 The default setting changes when the setting for o2-04 [Drive Model Selection] changes.

Parameter Details

12.1	Section Safety	638
12.2	A: Initialization Parameters	639
12.3	b: Application	658
12.4	C: Tuning	711
12.5	d: References	738
12.6	E: Motor Parameters	759
12.7	F: Options	780
12.8	H: Terminal Functions	822
12.9	L: Protection Functions	900
12.10	n: Special Adjustment	949
12.11	o: Keypad-Related Settings	975
12.12	T: Auto-Tuning	997

12.1 Section Safety

 **DANGER**

Do not ignore the safety messages in this manual.

If you ignore the safety messages in this manual, it will cause serious injury or death. The manufacturer is not responsible for injuries or damage to equipment.

12.2 A: Initialization Parameters

A parameters [Initialization Parameters] set the operating environment and operating conditions for the drive.

◆ A1: Initialization

A1 parameters set the operating environment and operating conditions for the drive. For example, these parameters set the keypad language, the control method, and the parameter access level for the drive.

■ A1-00: Language Selection

No. (Hex.)	Name	Description	Default (Range)
A1-00 (0100) RUN	Language Selection	V/f CL-V/f OLV CLV AOLV OLV/PM AOLV/PM CLV/PM EZOLV Sets the language for the LCD keypad.	0 (0 - 12)

Note:

- This parameter is only available when you use an LCD keypad or a Bluetooth LCD Keypad.
- When you use A1-03 [Initialize Parameters] to initialize the drive, the drive will not set this parameter to factory default.

0 : English

1 : Japanese

2 : German

3 : French

4 : Italian

5 : Spanish

6 : Portuguese

7 : Chinese

8 : Czech

9 : Russian

10 : Turkish

11 : Polish

12 : Greek

■ A1-01: Access Level Selection

No. (Hex.)	Name	Description	Default (Range)
A1-01 (0101) RUN	Access Level Selection	V/f CL-V/f OLV CLV AOLV OLV/PM AOLV/PM CLV/PM EZOLV Sets user access to parameters. The access level controls which parameters the keypad will display, and which parameters the user can set.	2 (0 - 3)

0 : Operation Only

Access to A1-00, A1-01, A1-04 [Password], and the U Monitors.

1 : User Parameters

Access to A1-00, A1-01, A1-04, and A2-01 to A2-32 [User Parameters 1 to 32].

2 : Advanced Level

Access to all parameters, but not Expert Mode parameters.

3 : Expert Level

Access to all parameters including Expert Mode parameters.

Table 12.1 shows which keypad screens are available for each A1-01 settings.

Table 12.1 Access Level and Available Keypad Screens

Mode	Keypad Screen	A1-01 [Access Level Selection] Setting			
		0	1	2	3
Drive Mode	Monitors	Yes	Yes	Yes	Yes
Programming Mode	Parameters	Yes	Yes	Yes	Yes
	User Custom Parameters	No	Yes	Yes	Yes
	Parameter Backup/Restore	No	No	Yes	Yes
	Modified Parameters/Fault Log	No	No	Yes	Yes
	Auto-Tuning	No	No	Yes	Yes
	Initial Setup Screen	No	No	Yes	Yes
	Diagnostic Tools	No	No	Yes	Yes

Note:

- When you use A1-04 and A1-05 [Password Setting] to set a password, you cannot change the values set in A1-01 to A1-03, A1-06, A1-07, or A2-01 to A2-32.
- When H1-xx = 1B [MFDI Function Select = Program Lockout], you must activate the terminal to change parameter settings.
- When you use MEMOBUS/Modbus communications, you must send the Enter command from the controller to the drive and complete the serial communication write process before you can use the keypad to change parameter settings.

■ A1-02: Control Method Selection

No. (Hex.)	Name	Description	Default (Range)
A1-02 (0102)	Control Method Selection	V/f CL-V/f OLV CLV AOLV OLV/PM AOLV/PM CLV/PM EZOLV Sets the control method for the drive application and the motor.	2 (0 - 8)

Note:

When you change the A1-02 setting, the parameter values specified by A1-02 are changed to their default values.

Sets the control method for the drive application and the motor.

0 : V/f Control

Use this control method in these applications and conditions:

- For general variable-speed control applications in which a high level of responsiveness or high-precision speed control is not necessary.
- To connect more than one motor to one drive
- When there is not sufficient data to set the motor parameters
- When it is not possible to do Auto-Tuning. The speed control range is 1:40.

1 : V/f Control with Encoder

Use this control method in these applications and conditions:

- For general variable-speed control applications in which a high level of responsiveness or high-precision speed control is not necessary.
- When there is not sufficient data to set the motor parameters
- When it is not possible to do Auto-Tuning. The speed control range is 1:40.

2 : Open Loop Vector

Use this control method for general variable-speed control applications in which high-precision speed control is necessary. In this control method, a feedback signal from the motor is not necessary to have high torque response and high torque when operating at low speeds. The speed control range is 1:120.

3 : Closed Loop Vector

Use this control method for general variable-speed control applications in which these qualities are necessary:

- A high level of responsiveness
- High-precision speed control up to zero speed

- High-precision torque control. A speed feedback signal from the motor is necessary for this control method. The speed control range is 1:1500.

4 : Advanced Open Loop Vector

This is a control method for induction motors. Use this control method for applications in which high-precision speed control is necessary.

This control method has high speed and torque response and high torque when operating at low speeds. The speed control range is 1:200.

5 : PM Open Loop Vector

The drive controls an IPM motor or SPM motor in this control method. Use this control method for general variable-speed control applications in which a high level of responsiveness or high-precision speed control are not necessary. The speed control range is 1:20.

6 : PM Advanced Open Loop Vector

The drive can control an IPM motor in this control method. Use this control method for general variable-speed control applications in which high-precision speed control and torque limit are necessary. The speed control range is 1:20. The speed control range is 1:100 when $n8-57 = 1$ [*HFI Overlap Selection = Enabled*].

7 : PM Closed Loop Vector

The drive controls a PM motor in this control method. Use this control method for constant torque applications in which high-precision control with a PM motor is necessary. Also use this control method for general variable-speed control applications in which high torque response and high-precision torque control are necessary. A speed feedback signal from the motor is necessary for this control method. The speed control range is 1:1500.

8 : EZ Vector Control

The drive controls SynRM (Synchronous Reluctance Motors) in this control method. This control method uses an easier procedure to operate motors with more efficiency. Use this control method for derating torque applications. For example, fans and pumps.

■ A1-03: Initialize Parameters

No. (Hex.)	Name	Description	Default (Range)
A1-03 (0103)	Initialize Parameters	<div style="display: flex; justify-content: space-between; align-items: center;"> V/f CL-V/f OLV CLV AOLV OLV/PM AOLV/PM CLV/PM EZOLV </div> Sets parameters to default values.	0 (0 - 3330)

Note:

- After you initialize the drive, the drive automatically sets $A1-03 = 0$.
- User Parameters can save the parameter values for your application and use these values as default values for drive initialization.
- To use the 2 motor switchover function, first turn OFF the terminal to which $H1-xx = 16$ [*MFDI Function Selection = Motor 2 Selection*] is set, then change the A1-03 setting. An incorrect procedure will trigger $oPE08$ [*Parameter Selection Error*].

0 : No Initialization

1110 : User Initialization

Sets parameters to the values set by the user as user settings. Set $o2-03 = 1$ [*User Parameter Default Value = Set defaults*] to save the user settings.

You can save the parameter settings that were adjusted for the test run as user-set default values to the drive. When you make changes to the parameter values after you save the settings as User Parameter Settings, the drive will set the parameters to the User Parameter Setting value when you initialize with $A1-03 = 1110$.

Follow this procedure to save User Parameter setting values, and to do a User Initialization.

1. Set parameters correctly for the application.
2. Set $o2-03 = 1$ [*User Parameter Default Value = Set defaults*].
This saves parameter settings for a User Initialization.
The drive will then automatically set $o2-03 = 0$.
3. Set $A1-03 = 1110$ to reset to the saved parameter settings.
When you initialize the drive, the drive sets the parameter values to the User Parameter setting values.

2220 : 2-Wire Initialization

Sets MFDI terminal S1 to Forward Run and terminal S2 to Reverse Run, and resets all parameters to default settings.

3330 : 3-Wire Initialization

Sets MFDI terminal S1 to Run, terminal S2 to Stop, and terminal S5 to FWD/REV, and resets all parameters to default settings.

The drive will not initialize the parameters in [Table 12.2](#) when $A1-03 = 2220, 3330$.

Table 12.2 Parameters that are not Initialized Using a 2-Wire Sequence or a 3-Wire Sequence

No.	Name
A1-00	Language Selection
A1-02	Control Method Selection
A1-07	DriveWorksEZ Function Selection
E1-03	V/f Pattern Selection
E5-01	PM Motor Code Selection
E5-02	PM Motor Rated Power (kW)
E5-03	Motor Rated Current (FLA)
E5-04	PM Motor Pole Count
E5-05	PM Motor Resistance (ohms/phase)
E5-06	PM d-axis Inductance (mH/phase)
E5-07	PM q-axis Inductance (mH/phase)
E5-09	PM Back-EMF Vpeak (mV/(rad/s))
E5-11	Encoder Z-Pulse Offset
E5-24	PM Back-EMF L-L Vrms (mV/rpm)
E5-25	Polarity Estimation Timeout
F6-08	Comm Parameter Reset @Initialize
F6-xx/F7-xx	Communication Option Parameters Set $F6-08 = 1$ [<i>Comm Parameter Reset @Initialize = Reset Back to Factory Default</i>] to initialize communication option card parameters.
L8-35	Installation Method Selection
o2-04	Drive Model (KVA) Selection
o2-24	LED Light Function Selection
q1-xx - q8-xx	DriveWorksEZ Parameters
r1-xx	DWEZ Connection 1-20

Note:

- Set $A1-06$ [*Application Preset*] to let the drive automatically set the best parameter settings for the selected application. The drive does not initialize $A1-02$ when $A1-03 = 2220, 3330$.
- When $A1-03 = 2220, 3330$, the drive automatically set $A1-05$ [*Password Setting*] = 0000. Make sure that you set the password again for applications where a password is necessary.

■ A1-04: Password

No. (Hex.)	Name	Description	Default (Range)
A1-04 (0104)	Password	<div style="display: flex; gap: 5px;"> V/f CL-V/f OLV CLV AOLV OLV/PM AOLV/PM CLV/PM EZOLV </div> Entry point for the password set in $A1-05$ [<i>Password Setting</i>]. The user can view the settings of parameters that are locked without entering the password. Enter the correct password in this parameter to change parameter settings.	0000 (0000 - 9999)

If the password entered in $A1-04$ does not agree with the password setting in $A1-05$, you cannot change these parameters:

- $A1-01$ [*Access Level Selection*]
- $A1-02$ [*Control Method Selection*]
- $A1-03$ [*Initialize Parameters*]
- $A1-06$ [*Application Preset*]

- A1-07 [DriveWorksEZ Function Selection]
- A2-01 to A2-32 [User Parameter 1 to 32]















To lock parameter settings after making changes without changing the password, enter the incorrect password in A1-04 and push .

Enter the Password to Unlock Parameters

Use this procedure to unlock parameter settings.









Set the password in A1-05 [Password Setting], and show the Parameter Setting Mode screen on the keypad.

This procedure verifies the password, and makes sure that the parameter settings are unlocked.

1. Push  or  to select "A: Initialization Parameters", then push .
2. Push  or  to select [A1-04], then push .
You can now change parameter settings.
3. Push  or  to move the digit and enter the password.
4. Push  to confirm the password.
The drive unlocks the parameters and automatically shows the Parameters Screen.
5. Push  or  to show [A1-02], then push .
6. Push  or  to make sure that you can change the setting value.

Push  (Back) until the keypad shows the Parameter Setup Mode screen.



■ A1-05: Password Setting

No. (Hex.)	Name	Description	Default (Range)
A1-05 (0105)	Password Setting	         Set the password to lock parameters and prevent changes to parameter settings. Enter the correct password in A1-04 [Password] to unlock parameters and accept changes.	0000 (0000 - 9999)

This parameter can lock these parameter settings:

- A1-01 [Access Level Selection]
- A1-02 [Control Method Selection]
- A1-03 [Initialize Parameters]
- A1-06 [Application Preset]
- A1-07 [DriveWorksEZ Function Selection]
- A2-01 to A2-32 [User Parameter 1 to 32]

Note:

- Usually, the keypad will not show A1-05. To show and set A1-05, show A1-04 [Password] and then push  and  on the keypad at the same time.
- After you set A1-05, the keypad will not show it again until you enter the correct password in A1-04. Make sure that you remember the A1-05 setting value. If you do not know the A1-05 setting value, contact Yaskawa or your nearest sales representative.
- When A1-03 = 2220, 3330 [2-Wire Initialization, 3-Wire Initialization], the drive is initialized to A1-05 = 0000. Be sure to set the password again when a password is necessary for the application.
- Change the setting value in A1-05 to change the password. The new setting value becomes the new password.
- When you use the password to unlock and change a parameter, enter a value other than the password in A1-04 to lock the parameter again with the same password.
- If A1-04 ≠ A1-05, MEMOBUS Communication cannot read or write A1-05.

■ A1-06: Application Preset

WARNING! Sudden Movement Hazard. Check the I/O signals and the external sequences for the drive before you set the Application Preset function. When you set the Application Preset function (A1-06 ≠ 0), it changes the I/O terminal functions for the drive and it can cause equipment to operate unusually. This can cause serious injury or death.

12.2 A: Initialization Parameters

No. (Hex.)	Name	Description	Default (Range)
A1-06 (0127)	Application Preset	<div style="display: flex; justify-content: space-between; align-items: center;"> V/f CL-V/f OLV CLV AOLV OLV/PM AOLV/PM CLV/PM EZOLV </div> Sets the drive to operate in selected application conditions.	0 (0 - 5)

The drive software contains the application presets shown below. Set *A1-06* to align with the application to let the drive automatically set the best parameter settings for the selected application. The drive saves parameters frequently used for the application in parameters *A2-01* to *A2-16* [*User Parameters 1 to 16*] for easy configuration and reference in [*User Custom Parameters*] in the main menu.

- Water supply pump
- Conveyor
- Exhaust fan
- HVAC fan
- Air compressor

Note:

• Before you set *A1-06*, make sure that you set *A1-03* = 2220, 3330 [*Initialize Parameters = 2-Wire Initialization, 3-Wire Initialization*] to initialize parameters.

• It is not possible to change the *A1-06* value. To set an application preset, first set *A1-03* = 2220 to initialize parameters, then set this parameter. If initializing all parameters will cause a problem, do not change the settings.

If you set *A2-33* = 1 [*User Parameter Auto Selection = Enabled: Auto Save Recent Params*] to set parameters to *A2-17* to *A2-32* [*User Parameters 17 to 32*] automatically, the drive will reset these parameters when you change the *A1-06* setting.

0 : General-purpose

The drive saves the parameters in [Table 12.3](#) as user parameters.

Table 12.3 Parameters Saved as User Parameters with the General-purpose Preset

User Parameter No.	Parameter No. Saved	Name
A2-01	A1-02	Control Method Selection
A2-02	b1-01	Frequency Reference Selection 1
A2-03	b1-02	Run Command Selection 1
A2-04	b1-03	Stopping Method Selection
A2-05	C1-01	Acceleration Time 1
A2-06	C1-02	Deceleration Time 1
A2-07	C6-01	Normal / Heavy Duty Selection
A2-08	C6-02	Carrier Frequency Selection
A2-09	d1-01	Reference 1
A2-10	d1-02	Reference 2
A2-11	d1-03	Reference 3
A2-12	d1-04	Reference 4
A2-13	d1-17	Jog Reference
A2-14	E1-01	Input AC Supply Voltage
A2-15	E1-03	V/f Pattern Selection
A2-16	E1-04	Maximum Output Frequency
A2-17	E1-05	Maximum Output Voltage
A2-18	E1-06	Base Frequency
A2-19	E1-09	Minimum Output Frequency
A2-20	E1-13	Base Voltage
A2-21	E2-01	Motor Rated Current (FLA)
A2-22	E2-04	Motor Pole Count
A2-23	E2-11	Motor Rated Power

User Parameter No.	Parameter No. Saved	Name
A2-24	H4-02	Terminal FM Analog Output Gain
A2-25	L1-01	Motor Overload (oL1) Protection
A2-26	L3-04	Stall Prevention during Decel

1 : Water Supply Pump 2

The drive automatically sets the parameters in [Table 12.4](#) for a water supply pump application.

Table 12.4 Best Parameter Settings for Water Supply Pump Applications

No.	Name	Optimal Value
A1-02	Control Method Selection	0: V/f Control
b1-04	Reverse Operation Selection	1: Reverse Disabled
C1-01	Acceleration Time 1	1.0 s
C1-02	Deceleration Time 1	1.0 s
C6-01	Normal / Heavy Duty Selection	1: Normal Duty Rating
E1-03	V/f Pattern Selection	F: Custom
E1-07	Mid Point A Frequency	30.0 Hz
E1-08	Mid Point A Voltage	50.0 V
L2-01	Power Loss Ride Through Select	1: Enabled
L3-04	Stall Prevention during Decel	1: Enabled

The drive saves the parameters in [Table 12.5](#) as user parameters.

Table 12.5 Parameters Saved as User Parameters with the Water Supply Pump Preset

User Parameter No.	Parameter No. Saved	Name
A2-01	b1-01	Frequency Reference Selection 1
A2-02	b1-02	Run Command Selection 1
A2-03	b1-04	Reverse Operation Selection
A2-04	C1-01	Acceleration Time 1
A2-05	C1-02	Deceleration Time 1
A2-06	E1-03	V/f Pattern Selection
A2-07	E1-07	Mid Point A Frequency
A2-08	E1-08	Mid Point A Voltage
A2-09	E2-01	Motor Rated Current (FLA)
A2-10	H1-05	Terminal S5 Function Selection
A2-11	H1-06	Terminal S6 Function Selection
A2-12	H1-07	Terminal S7 Function Selection
A2-13	L5-01	Number of Auto-Restart Attempts

2 : Conveyor

The drive automatically sets the parameters in [Table 12.6](#) for a conveyor application.

Table 12.6 Best Parameter Settings for Conveyor Applications

No.	Name	Optimal Value
A1-02	Control Method Selection	0: V/f Control
C1-01	Acceleration Time 1	3.0 s
C1-02	Deceleration Time 1	3.0 s

12.2 A: Initialization Parameters

No.	Name	Optimal Value
C6-01	Normal / Heavy Duty Selection	0: Heavy Duty Rating
L3-04	Stall Prevention during Decel	1: Enabled

The drive saves the parameters in [Table 12.7](#) as user parameters.

Table 12.7 Parameters Saved as User Parameters with the Conveyor Preset

User Parameter No.	Parameter No. Saved	Name
A2-01	A1-02	Control Method Selection
A2-02	b1-01	Frequency Reference Selection 1
A2-03	b1-02	Run Command Selection 1
A2-04	C1-01	Acceleration Time 1
A2-05	C1-02	Deceleration Time 1
A2-06	E2-01	Motor Rated Current (FLA)
A2-07	L3-04	Stall Prevention during Decel

3 : Exhaust Fan

The drive automatically sets the parameters in [Table 12.8](#) for an exhaust fan application.

Table 12.8 Best Parameter Settings for Exhaust Fan Applications

No.	Name	Optimal Value
A1-02	Control Method Selection	0: V/f Control
b1-04	Reverse Operation Selection	1: Reverse Disabled
C6-01	Normal / Heavy Duty Selection	1: Normal Duty Rating
E1-03	V/f Pattern Selection	F: Custom
E1-07	Mid Point A Frequency	30.0 Hz
E1-08	Mid Point A Voltage	50.0 V
L2-01	Power Loss Ride Through Select	1: Enabled
L3-04	Stall Prevention during Decel	1: Enabled

The drive saves the parameters in [Table 12.9](#) as user parameters.

Table 12.9 Parameters Saved as User Parameters with the Exhaust Fan Preset

User Parameter No.	Parameter No. Saved	Name
A2-01	b1-01	Frequency Reference Selection 1
A2-02	b1-02	Run Command Selection 1
A2-03	b1-04	Reverse Operation Selection
A2-04	b3-01	Speed Search at Start Selection
A2-05	C1-01	Acceleration Time 1
A2-06	C1-02	Deceleration Time 1
A2-07	E1-03	V/f Pattern Selection
A2-08	E1-07	Mid Point A Frequency
A2-09	E1-08	Mid Point A Voltage
A2-10	E2-01	Motor Rated Current (FLA)
A2-11	H1-05	Terminal S5 Function Selection
A2-12	H1-06	Terminal S6 Function Selection
A2-13	H1-07	Terminal S7 Function Selection
A2-14	L5-01	Number of Auto-Restart Attempts

4 : HVAC Fan

The drive automatically sets the parameters in [Table 12.10](#) for an HVAC fan application.

Table 12.10 Best Parameter Settings for HVAC Applications

No.	Name	Optimal Value
A1-02	Control Method Selection	0: V/f Control
b1-04	Reverse Operation Selection	1: Reverse Disabled
b1-17	Run Command at Power Up	1: Accept Existing RUN Command
C6-01	Normal / Heavy Duty Selection	1: Normal Duty Rating
C6-02	Carrier Frequency Selection	3: 8.0 kHz
H2-03	Terminal M5-M6 Function Selection	39: Watt Hour Pulse Output
L2-01	Power Loss Ride Through Select	2: Enabled while CPU Power Active
L8-03	Overheat Pre-Alarm Selection	4: Operate at Reduced Speed (L8-19)
L8-38	Carrier Frequency Reduction	2: Enabled for All Speeds

The drive saves the parameters in [Table 12.11](#) as user parameters.

Table 12.11 Parameters Saved as User Parameters with the HVAC Preset

User Parameter No.	Parameter No. Saved	Name
A2-01	b1-01	Frequency Reference Selection 1
A2-02	b1-02	Run Command Selection 1
A2-03	b1-03	Stopping Method Selection
A2-04	b1-04	Reverse Operation Selection
A2-05	C1-01	Acceleration Time 1
A2-06	C1-02	Deceleration Time 1
A2-07	C6-02	Carrier Frequency Selection
A2-08	d2-01	Frequency Reference Upper Limit
A2-09	d2-02	Frequency Reference Lower Limit
A2-10	E1-03	V/f Pattern Selection
A2-11	E1-04	Maximum Output Frequency
A2-12	E2-01	Motor Rated Current (FLA)
A2-13	H3-11	Terminal A2 Gain Setting
A2-14	H3-12	Terminal A2 Bias Setting
A2-15	L2-01	Power Loss Ride Through Select
A2-16	o4-12	kWh Monitor Initialization

5 : Air Compressor

The drive automatically sets the parameters in [Table 12.12](#) for an air compressor application.

Table 12.12 Best Parameter Settings for Air Compressor Applications

No.	Name	Optimal Value
A1-02	Control Method Selection	0: V/f Control
b1-04	Reverse Operation Selection	1: Reverse Disabled
C1-01	Acceleration Time 1	5.0 s
C1-02	Deceleration Time 1	5.0 s
C6-01	Normal / Heavy Duty Selection	0: Heavy Duty Rating
E1-03	V/f Pattern Selection	F: Custom

12.2 A: Initialization Parameters

No.	Name	Optimal Value
L2-01	Power Loss Ride Through Select	1: Enabled
L3-04	Stall Prevention during Decel	1: Enabled

The drive saves the parameters in [Table 12.13](#) as user parameters.

Table 12.13 Parameters Saved as User Parameters with the Air Compressor Preset

User Parameter No.	Parameter No. Saved	Name
A2-01	b1-01	Frequency Reference Selection 1
A2-02	b1-02	Run Command Selection 1
A2-03	b1-04	Reverse Operation Selection
A2-04	C1-01	Acceleration Time 1
A2-05	C1-02	Deceleration Time 1
A2-06	E1-03	V/f Pattern Selection
A2-07	E1-07	Mid Point A Frequency
A2-08	E1-08	Mid Point A Voltage
A2-09	E2-01	Motor Rated Current (FLA)

■ Notes for Elevator Applications

When using the drive for elevator applications, read the safety descriptions and precautions, and safely and correctly use the device.

Conditions to Open and Close the Brake

Set $L4-07 = 0$ [*Speed Agree Detection Selection = No Detection during Baseblock*] to open and close the holding brake.

When $L4-07 = 1$ [*Detection Always Enabled*], the output frequency increases when you input the Run command although the external baseblock command is input. Because of this, speed detection operates and will open the brake signal.

• Set Related Parameters

[Table 12.14](#) shows examples of parameter settings to use the MFDO terminal (M1-M2) as the holding brake open and close signal.

Table 12.14 Holding Brake Open and Close Signal Setting Example

Brake Open and Close Signal		Brake Open and Close Level Adjust		Applicable Control Methods (A1-02 Setting Value)				
Signal Name	Parameter Settings	Signal Name	Parameter Settings	V/f (0)	OLV (2)	CLV (3)	AOLV (4)	CLV/PM (7) ^{*1}
Frequency (FOUT) Detection 2	L4-07 = 0	Speed Agree Detection Level	L4-01 = 1.0 Hz to 3.0 Hz ^{*2}	x	x	-	x	-
	H2-01 = 5	Speed Agree Detection Width	L4-02 = 0.0 Hz to 0.5 Hz ^{*3}					
During Frequency Output	H2-01 = 37	DC Injection/Zero Speed Threshold	b2-01 = 0.1 Hz to 0.5 Hz	-	-	x	-	x

*1 When $A1-02 = 7$ [*PM Closed Loop Vector*], make sure that the motor can rotate before you do Auto-Tuning or switch the encoder. Refer to Closed Loop Vector Control for induction motors for information about the signal to use and the adjustment method.

*2 When $A1-02 = 2$ [*Open Loop Vector*], it is the usual setting range. When $A1-02 = 0$ [*V/f Control*], set $L4-01$ to the rated slip frequency of the motor + approximately 0.5 Hz. If you set the value too low, motor torque will not be sufficient and it will cause motor rollback. Set the parameters to meet these conditions at the same time. If the setting is too high, overshoot is possible at start.

- $L4-01 > E1-09$ [*Minimum Output Frequency*]
- $L4-01 > L4-02$ [*Speed Agree Detection Width*]

*3 Use $L4-02$ to adjust the detection width of Frequency Detection 2. If rollback occurs when the motor is stopped, set the frequency to approximately 0.1 Hz.

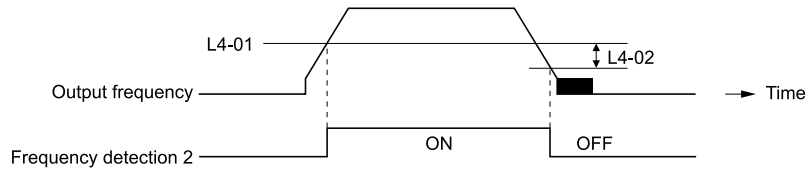

Figure 12.1 Frequency Detection 2

Sequence Circuit Configuration

Use these conditions to set the circuit for the open/close sequence of the holding brake:

- Set the sequence-side operation conditions to activate terminal M1-M2 and open the holding brake.
- Set the sequence to close the holding brake in an emergency if the drive detects a fault.
- Set the sequence to open the holding brake when you enter an increase or decrease command.

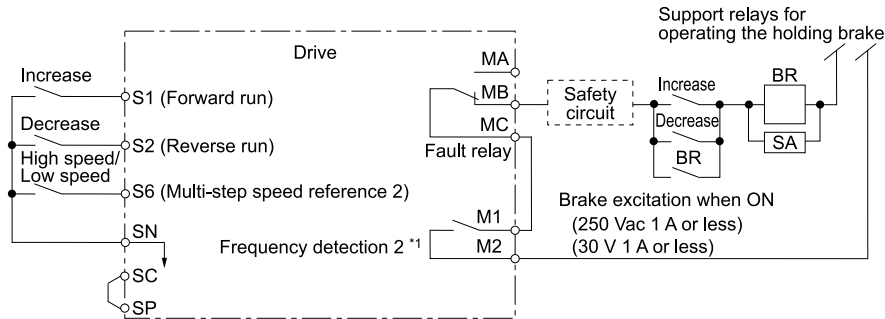

Figure 12.2 Sequence Circuit Configuration Diagram

*1 L4-07 = 0 [Speed Agree Detection Selection = No Detection during Baseblock] or During Frequency Output

Time Chart

Figure 12.3 shows the open/close sequence of the holding brake.

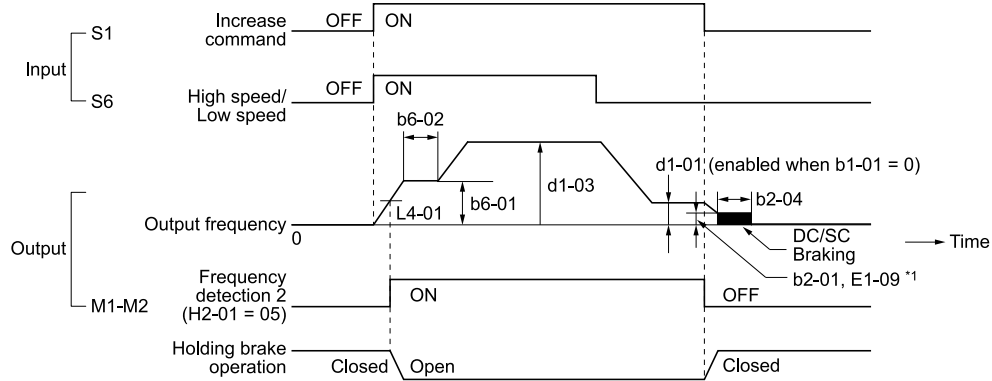

Figure 12.3 Holding Brake Open and Close Sequence Time Chart (V/f, CL-V/f, OLV)

*1 Start braking from the higher set frequency between b2-01 [DC Injection/Zero SpeedThreshold] or E1-09 [Minimum Output Frequency].

12.2 A: Initialization Parameters

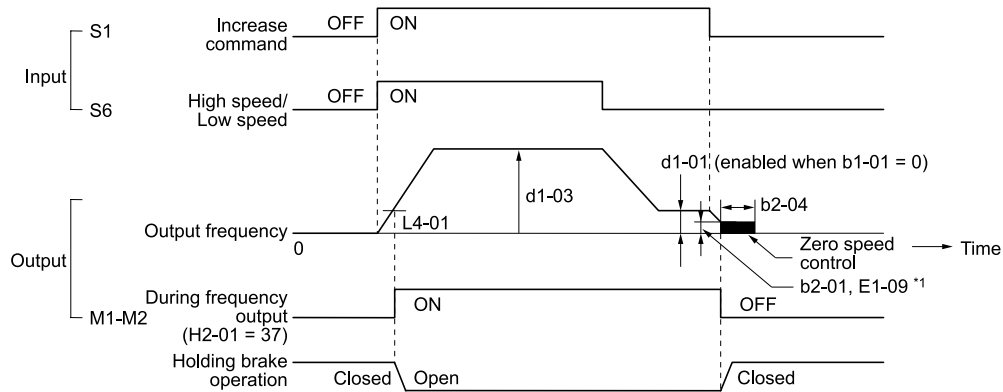

Figure 12.4 Holding Brake Open and Close Sequence Time Chart (CLV, CLV/PM)

*1 Start braking from the higher set frequency between $b2-01$ [DC Injection/Zero SpeedThreshold] or $E1-09$ [Minimum Output Frequency].

Notes on when Using Other Functions

Function	Notes
Decel stall prevention function	<p>When you connect a braking resistor to discharge the regenerative power to the drive, set $L3-04 = 0$ [Stall Prevention during Decel = Disabled].</p> <p>Note:</p> <ul style="list-style-type: none"> If $L3-04 = 1$ [General Purpose], it is possible that the drive will not stop in the set deceleration time. Do not change the default settings of these related parameters: <ul style="list-style-type: none"> • $L3-01 = 1$ [Stall Prevention during Accel = Enabled] • $L3-05 = 1$ [Stall Prevention during RUN = Deceleration Time 1 (C1-02)]
Auto-Tuning for Induction Motors	<ul style="list-style-type: none"> • When $A1-02 = 2, 3, 4$ [Control Method Selection = Open Loop Vector, Closed Loop Vector, Advanced Open Loop Vector], Auto-Tune the motor before you operate the drive. • Disconnect the drive from the motor to do Rotational Auto-Tuning. • Auto-Tuning runs automatically for approximately 1 minute. Do not do Auto-Tuning with the motor engaged in the elevator system. <p>Note:</p> <ul style="list-style-type: none"> • If you cannot disconnect the motor from the machine, do Stationary Auto-Tuning. During this time, the drive automatically measures the necessary motor data. If the motor test report or the motor nameplate is not available, use Stationary Auto-Tuning. Do Stationary Auto-Tuning for Line-to-Line Resistance for better torque characteristics at low speeds in the V/f Control mode. • When you do Stationary Auto-Tuning, the drive energizes the motor and the motor stays stopped. • To Auto-Tune a specialized motor, for example a wound motor, prepare a motor test report before Auto-Tuning and make sure that the motor parameter $E2-xx$ is not too different than the value in the test report.
Auto-Tuning for PM Motors	<p>You must set the motor data in the drive to run a PM motor.</p> <ul style="list-style-type: none"> • When you use a PM motor recommended by Yaskawa Input the motor code in $E5-01$. $E5$ and other related motor parameters will be automatically set to the optimal values. • When you use a non-Yaskawa PM motor Do Auto-Tuning. <ul style="list-style-type: none"> – When the motor nameplate or motor test report is available, enter the PM motor parameters directly with PM Motor Parameter Settings. – If the motor nameplate or motor test report is not available, and the motor cannot rotate, do PM Stationary Auto-Tuning. – If the motor nameplate or motor test report is not available, and the motor can rotate, do PM Rotational Auto-Tuning. – When you replace an encoder, make sure that the motor can rotate and do Z Pulse Offset Tuning or PM Rotational Auto-Tuning. <p>Note:</p> <ul style="list-style-type: none"> • Use in Closed Loop Vector Control for PM mode. • When you do Auto-Tuning or replace the encoder, make sure that the motor can rotate. • Set the Encoder Z-Pulse Offset. • Refer to Closed Loop Vector Control for induction motors for information about the signal to use and the adjustment method.
Braking Resistor Overheat Protection	<p>When you use a braking resistor other than the optional Yaskawa braking resistor unit (LKEB-series), this function uses the thermal overload relay to detect braking resistor overheat. Load a sequence program that turns OFF the drive input power supply when the braking resistor overheats.</p> <p>Note:</p> <p>Refer to 62 when you load the sequence circuit.</p>
Continuous operation function	<p>Do not use the momentary power loss continuous operation function and the Auto Restart function. If you use these functions, there is a risk that the motor will coast to a stop if the brake is open when there is a momentary power loss and the drive is operating or if there is a fault.</p> <p>Set the these parameters:</p> <ul style="list-style-type: none"> • $L2-01 = 0$ [Power Loss Ride Through Select = Disabled] • $L5-01 = 0$ [Number of Auto-Restart Attempts = 0]
Torque limit function	<p>The motor rated torque sets the value for $L7-01$ to $L7-04$ [Torque Limit]. If there will not be sufficient torque during start up, replace the drive with a larger capacity drive and set the torque limit between 200% and 300%. The $L7-01$ to $L7-04$ default setting is 200%.</p>

Function	Notes
I/O phase loss protection, overtorque detection function	<p>To stop a fall because of motor phase loss, set these parameters.</p> <ul style="list-style-type: none"> L8-05 = 1 [Input Phase Loss Protection Sel = Enabled] L8-07 = 1 [Output Phase Loss Protection Sel = Fault when one phase is lost] L6-01, L6-04 = 1 to 8 [Torque Detection Selection 1/2 = oL @ Speed Agree - Alarm only to UL @ RUN - Fault] L6-02, L6-05 [Torque Detection Level 1/2] L6-03, L6-06 [Torque Detection Time 1/2] <p>Note: Use precautions, for example fall detection, on the machine side.</p>
External baseblock command	<ul style="list-style-type: none"> If you enter the external baseblock signal set in H1-01 to H1-08 = 8 or 9 [Terminal S1 to S8 Function Selection = Baseblock Command] during run, the motor immediately coasts to stop. When you enter a baseblock command while the motor is operating, make sure that it is necessary. When you use an external baseblock command for the fast stop and operation start up interlocks, load the sequence to lock the holding brake when you enter the external baseblock command. If you enter the external baseblock command and then immediately remove it, the drive will not output the voltage in the time set in L2-03 [Minimum Baseblock Time]. Do not use an external baseblock command for applications that have frequent Run/Stop commands.
Acceleration and deceleration times	<p>If you set the acceleration and deceleration times for the drive side too short and you do not add the mechanical operation delay time of the holding brake, the holding brake could operate late, or there could be overcurrent at start up, the brake could grind, or the motor could roll back when it stops. In these conditions, use Dwell Reference at Start/Time and DC Injection Braking at Stop to adjust the holding brake timing.</p>
Electromagnetic contactor on the drive output side	<p>Usually you must not install the electromagnetic contactor between the drive and motor. When you must install an electromagnetic contactor to use one drive to switchover more than one motor, follow these precautions:</p> <ul style="list-style-type: none"> Load a sequence that opens and closes the electromagnetic contactor when these two conditions are satisfied at the same time, unless there is an emergency: <ul style="list-style-type: none"> The holding brake is fully closed The drive terminals for H2-xx = 8 or 1B [MFDO Function Selection = During Baseblock] are activated If you open and close the electromagnetic contactor during motor control or during DC Injection Braking (or zero speed control), the surge voltage and the motor direct input current can cause the drive to detect faults. When you use an electromagnetic contactor between the drive and motor, set L8-07 = 1 or 2 [Output Phase Loss Protection Sel = Fault when one phase is lost, Fault when two phases are lost].

Adjustments Relating to Control

When there is oscillation, rollback, or other control problems, adjust the parameters as specified by the control method.

V/f Control and Closed Loop V/f Control on page 651 shows only the frequently adjusted parameters.

Note:

Torque and speed response for high-resistance and high-slip motors are slow. Adjust the torque and speed response to increase them. Low impedance (low-slip) motors will hunt and oscillate. Adjust the torque and speed response to increase them.

V/f Control and Closed Loop V/f Control

While in V/f Control, do not use C3-01 [Slip Compensation Gain].

While in Closed Loop V/f Control, continue to use default settings for C5-01 to C5-05 [ASR Parameters]. Significantly altering the default settings will likely cause oscillation.

Table 12.15 Adjustment of Drive Control (V/f Control and Closed Loop V/f Control Methods)

Adjustment description	Parameter Number	Possible Solutions	Default	Recommended Setting
<ul style="list-style-type: none"> Prevent hunting and oscillation at middle-range speeds (10 Hz to 40 Hz) 	n1-02 [Hunting Prevention Gain Setting]	<ul style="list-style-type: none"> If the torque is not sufficient with heavy loads, decrease the setting. If there is hunting or oscillation with light loads, increase the setting. 	1.00	0.50 - 2.00
<ul style="list-style-type: none"> Increasing motor excitation sound Hunting and oscillation suppression at low speeds and middle-range speeds 	C6-02 [Carrier Frequency Selection]	<ul style="list-style-type: none"> If there is a loud motor excitation sound, increase the setting value. If there is hunting or oscillation at low speeds or middle-range speeds, decrease the setting value. 	*	1 - F
<ul style="list-style-type: none"> Increase torque at low speeds (10 Hz or lower) Prevent hunting and oscillation 	C4-01 [Torque Compensation Gain]	<ul style="list-style-type: none"> If the torque is not sufficient at low speeds, increase the setting value. If there is hunting or oscillation with light loads, decrease the setting value. 	1.00	0.50 - 1.50

Parameter Details

12.2 A: Initialization Parameters

Adjustment description	Parameter Number	Possible Solutions	Default	Recommended Setting
<ul style="list-style-type: none"> Increase torque at low speeds Prevent shock during start up 	E1-08 [Mid Point A Voltage]	<ul style="list-style-type: none"> If the torque is not sufficient at low speeds, increase the setting value. If there is a large shock during start up, decrease the setting value. 	15.0 V *2 *3	13.0 V to 16.0 V *3
	E1-10 [Minimum Output Voltage]		9.0 V *2 *3	7.0 V to 10.0 V *3

*1 The default setting changes when the settings for C6-01 [Normal / Heavy Duty Selection] and o2-04 [Drive Model (KVA) Selection] change.

*2 The default setting changes when the settings for A1-02 [Control Method Selection] and E1-03 [V/f Pattern Selection] change.

*3 This is the setting for 200 V class drives. Multiply the voltage by 2 for 400 V class drives.

Open Loop Vector Control Method

Do not adjust parameter C4-01 [Torque Compensation Gain]. Keep this parameter at its default setting.

If you cannot get speed accuracy during regeneration, set C3-04 = 1 [Slip Compensation at Regen = Enabled Above 6Hz]. If you cannot get speed accuracy at high speeds, set C3-05 = 1 [Output Voltage Limit Selection = Enabled].

Table 12.16 Adjustment of Drive Control (Open Loop Vector Control Method)

Adjustment description	Parameter Number	Possible Solutions	Default	Recommended Setting
<ul style="list-style-type: none"> Torque, increase speed response Prevent hunting and oscillation at middle-range speeds (10 Hz to 40 Hz) 	n2-01 [Automatic Freq Regulator Gain]	<ul style="list-style-type: none"> If torque and speed response are slow, decrease the setting value. If there is hunting or oscillation, increase the setting value. 	1.00	0.50 - 2.00
<ul style="list-style-type: none"> Torque, increase speed response Prevent hunting and oscillation 	C4-02 [Torque Compensation Delay Time] *1	<ul style="list-style-type: none"> If torque and speed response are slow, decrease the setting value. If there is hunting or oscillation, increase the setting value. 	20 ms	20 ms to 100 ms
<ul style="list-style-type: none"> Increase speed response Increase speed stability 	C3-02 [Slip Compensation Delay Time]	<ul style="list-style-type: none"> When speed response is slow, decrease the setting value. If speed is not stable, increase the setting value. 	200 ms	100 ms to 500 ms
<ul style="list-style-type: none"> Improve speed accuracy 	C3-01 [Slip Compensation Gain]	<ul style="list-style-type: none"> If speed is too slow, increase the setting value. If speed is too fast, decrease the setting value. 	1.0	0.5 - 1.5
<ul style="list-style-type: none"> Increasing motor excitation sound Prevent hunting and oscillation at low-range speeds (10 Hz to or lower) 	C6-02 [Carrier Frequency Selection]	<ul style="list-style-type: none"> If there is a loud motor excitation sound, increase the setting value. If there is hunting or oscillation at low speeds, decrease the setting value. 	*2	1 - F
<ul style="list-style-type: none"> Increase torque and speed response at low speeds Prevent shock during start up 	E1-08 [Mid Point A Voltage]	<ul style="list-style-type: none"> If the torque and speed response are slow, increase the setting value. If there is a large shock during start up, decrease the setting value. 	11.0 V *3	12.0 V to 13.0 V *3
	E1-10 [Minimum Output Voltage]		2.0 V *3	2.0 V to 3.0 V *3

*1 If the value for C4-02 [Torque Compensation Delay Time] is high, the current can increase during start up. Adjust and check the current during start up.

*2 The default setting changes when the settings for C6-01 [Normal / Heavy Duty Selection] and o2-04 [Drive Model (KVA) Selection] change.

*3 This is the setting for 200 V class drives. Multiply the voltage by 2 for 400 V class drives.

Closed Loop Vector Control Method

Table 12.17 Adjustment of Drive Control (Closed Loop Vector Control Method)

Adjustment description	Parameter Number	Possible Solutions	Default	Recommended Setting
<ul style="list-style-type: none"> Torque, increase speed response Prevent hunting and oscillation 	C5-01 [ASR Proportional Gain 1]	<ul style="list-style-type: none"> If the torque and speed response are slow, increase the setting value. If there is hunting or oscillation, decrease the setting value. 	20.00	10.00 - 50.00
	C5-03 [ASR Proportional Gain 2]			
<ul style="list-style-type: none"> Torque, increase speed response Prevent hunting and oscillation 	C5-02 [ASR Integral Time 1]	<ul style="list-style-type: none"> If torque and speed response are slow, decrease the setting value. If there is hunting or oscillation, increase the setting value. 	0.500 s	0.300 s to 1.000 s
	C5-04 [ASR Integral Time 2]			

Adjustment description	Parameter Number	Possible Solutions	Default	Recommended Setting
Change the ASR proportional gain and ASR integral time in accordance with the output frequency.	C5-07 [ASR Gain Switchover Frequency]	If you cannot establish ASR proportional gain or integral time for low speed or high speed, switch as specified by the output frequency.	0.0 Hz (Do not switch)	0.0 Hz to Maximum frequency
<ul style="list-style-type: none"> Prevent hunting and oscillation 	C5-06 [ASR Delay Time]	<ul style="list-style-type: none"> If there is unsatisfactory machine rigidity and oscillation is possible, increase the setting value. 	0.004 s	0.004 s to 0.020 s

Elevator Start/Stop and Accel/Decel Time Shock Reduction

S-Curve Characteristics, Accel & Decel Time

Adjustment Parameter	Name
C1-01, C1-03, C1-05, C1-07	Acceleration Time 1 to 4
C1-02, C1-04, C1-06, C1-08	Deceleration Time 1 to 4
C2-01	S-Curve Time @ Start of Accel
C2-02	S-Curve Time @ End of Accel
C2-03	S-Curve Time @ Start of Decel
C2-04	S-Curve Time @ End of Decel

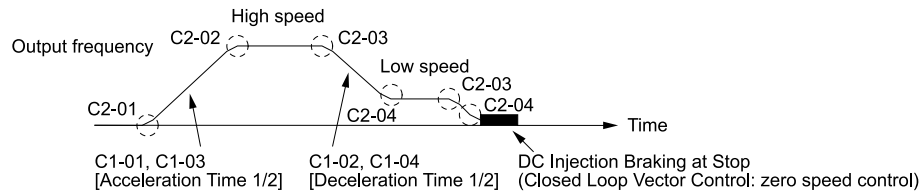

Figure 12.5 S-curve Characteristics, Accel & Decel Time

Note:

- When decreased operation times are necessary for the application, for example with cranes and hoists, do not use S-curve characteristic times.
- The default setting for *C2-04 [S-Curve Time @ End of Decel]* will be 0.00 seconds. The default setting for other S-curve characteristics will be 0.20 seconds. Set the acceleration/deceleration times and S-curve characteristic time correctly for acceleration/deceleration start up and end. The recommended setting of the S-curve characteristics time is 0.2 to 1.0 seconds.
- When you use the *C1-11 [Accel/Decel Time Switchover Freq]*, you can switch the acceleration/deceleration rate automatically during acceleration/deceleration. The default setting is disabled.
 When the Output Frequency \geq *C1-11*, operate at the acceleration and deceleration times set in *C1-01* and *C1-02*
 When the Output Frequency $<$ *C1-11*, operate at the acceleration and deceleration times set in *C1-07* and *C1-08*
- During low speed operation, if the Output Frequency $<$ *E1-09 [Minimum Output Frequency]* in the S-Curve Time @ Start of Decel, the drive will cancel the S-curve characteristics and will do DC Inject Braking at Stop (zero speed control).

Dwell Function at Start

Adjustment Parameter	Name
b6-01	Dwell Reference at Start
b6-02	Dwell Time at Start
H2-xx = 5	Frequency Detection 2

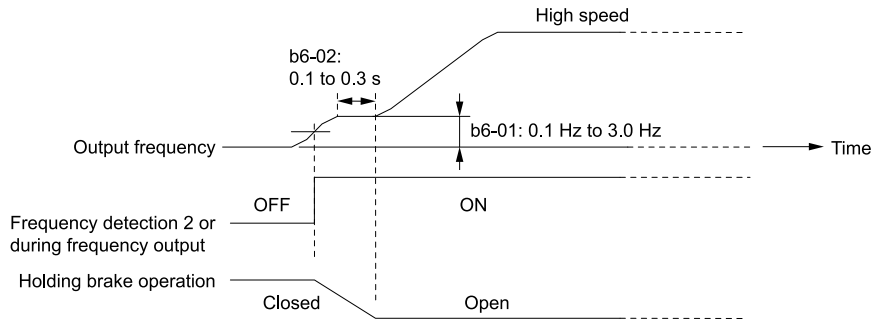

Figure 12.6 Dwell Function at Start

Note:

- If the mechanical operation of the holding brake is slow, use the Dwell Function at Start to prevent brake grinding (friction). Accelerate after the brake is fully open.
- When you use V/f Control and Open Loop Vector Control modes, set *b6-01 [Dwell Reference at Start] > Frequency Detection 2 (brake open frequency)*.
- If the motor torque is not sufficient during start up, use the DC Inject Braking function to secure the motor current (torque) before you start the motor.
 - b2-02 [DC Injection Braking Current]* recommended setting: 50% to 80% (V/f Control or Open Loop Vector Control)
 - b2-03 [DC Inject Braking Time at Start]* recommended setting: 0.2 s to 0.5 s

DC Injection Braking at Stop, Zero Speed Control Function

Note:

If you disconnect a drive when it is controlling the motor or during DC Injection Braking (Zero speed level), a voltage surge can trigger a fault. When you use an electromagnetic contactor between the drive and motor, set *L8-07 = 1 or 2 [Output Phase Loss Protection Sel = Fault when one phase is lost, Fault when two phases are lost]*. If it necessary to disconnect the motor and drive when you stop the elevator, fully close the holding brake and disconnect the drive during baseblock (that is, while the baseblock signal is ON). This does not apply for emergency conditions.

Adjustment Parameter	Name
b2-01	DC Injection/Zero SpeedThreshold
b2-02	DC Injection Braking Current
b2-04	DC Inject Braking Time at Stop
H2-xx = 5	Frequency Detection 2

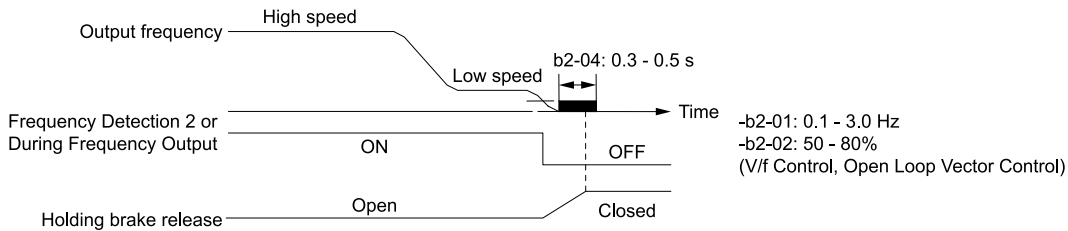

Figure 12.7 DC Injection Braking at Stop, Zero Speed Control Function

Note:

- If the mechanical operation of the holding brake is slow, use DC Injection Braking (zero speed control when set to closed loop vector) until the brake is fully closed to prevent rollback.
- If you cannot hold the load with DC Injection Braking when it is stopped in V/f Control and Open Loop Vector Control modes, use Dwell Function at Stop.
 - b6-03 [Dwell Reference at Stop]:* Minimum output frequency to 3.0 Hz
When Frequency Detection 2 is OFF, it is less than *L4-01 [Speed Agree Detection Level] - L4-02 [Speed Agree Detection Width]*.
 - b6-04 [Dwell Time at Stop]* recommended setting: 0.3 s to 0.5 s
 - b2-04 [DC Inject Braking Time at Stop]* recommended setting: 0.0 s

Torque Compensation (Torque Bias)

This function enters the torque compensation (torque bias) signal that matches a set load from the MFAI terminal in Closed Loop Vector Control to decrease the overshoot when you open and close the brake. You must detect the load

and motoring/regeneration on the machine side before you use the function. If there is a polarity error, shock can increase.

Item	Description
Sequence Circuit Configuration	<p>H3-05 (Terminal A3 Signal Level Select) = 1 (-10 to +10 V) H3-06 (Terminal A3 Function Selection) = 14 [Torque Compensation (Torque Bias)] Fine tune by H3-07 and H3-08</p>
Time chart: Increase	<p>Enter the analog signal as the torque compensation (torque bias) signal as specified by the load quantity before drive operation until drive operation completes. The default setting is 10 V/100% torque. Enter a positive polarity during a motoring load, and enter a negative polarity during a regenerative load.</p>
Time chart: Decrease	<p>Enter the analog signal as the torque compensation (torque bias) signal as specified by the load quantity before drive operation until drive operation completes. The default setting is 10 V/100% torque. Enter a negative polarity during a motoring load, and enter a positive polarity during a regenerative load.</p>

12.2 A: Initialization Parameters

Note:

- Holds through an external source to not change the torque compensation signal during run. If you change the torque compensation signal during run, the motor can oscillate.
- When you set motor reverse to the increase command and set motor forward to the decrease command, the polarity of the torque compensation signal will reverse.

Analog Input FilterTime Constant

- Minimize the effects of noise.
- Change *H3-13 [Analog Input FilterTime Constant]* to a range of 0.01 s to 0.10 s.

Startup Current Check

When you do a test run, set *L8-41 = 1 [High Current Alarm Selection = Enabled]* and use *U4-13 [Peak Hold Current]* and a clamp ammeter with the machine under load and not under load to check the motor current during start up.

If the motor torque is not sufficient during start up or if the timing between the motor and the holding brake is unsatisfactory and causes the motor to lock, a large quantity of current will flow. In these conditions, adjust the parameters again and decrease the load to decrease the current to less than 150%. If the current flow is more than 150% of the drive rated current, the heat stress on the IGBTs will decrease the service life of drive parts.

To decrease the effects of heat stress, decrease the carrier frequency of the drive to 2.0 kHz to 2.5 kHz for applications where low audible noise is not necessary.

Overvoltage Suppression Function

The overvoltage suppression function is designed to prevent an overvoltage trip in a situation in which a braking resistor is not used with a regenerative load. If the overvoltage suppression function is enabled, the regeneration torque reference within the drive is automatically controlled during regeneration.

Note:

■ A1-07: DriveWorksEZ Function Selection

No. (Hex.)	Name	Description	Default (Range)
A1-07 (0128)	DriveWorksEZ Function Selection	 Sets the drive to operate with DriveWorksEZ.	0 (0 - 2)

DriveWorksEZ is a simple visual programming tool that lets you connect function blocks to customize the drive and add PLC functions.

Note:

- DriveWorksEZ will overwrite drive settings when it uses MFDI/MFDO and MFAI/MFAO. When you use DriveWorksEZ to make changes to the drive, the changes will stay after you disable DriveWorksEZ.
- For more information about DriveWorksEZ, contact Yaskawa or your nearest sales representative.

0 : DWEZ Disabled

1 : DWEZ Enabled

2 : Enabled/Disabled wDigital Input

Set *H1-xx = 9F [MFDI Function Select = DWEZ Disable]*. Deactivate the digital input to enable programs made with DriveWorksEZ and activate the terminal to disable the programs.

■ A1-11: Firmware Update Lock

No. (Hex.)	Name	Description	Default (Range)
A1-11 (111D) Expert	Firmware Update Lock	 Protects the drive firmware. When you enable the protection, you cannot update the drive firmware.	0 (0, 1)

0 : Disabled

Lock is disabled.

1 : Enabled

Lock is enabled.

■ A1-12: Bluetooth ID

No. (Hex.)	Name	Description	Default (Range)
A1-12 (1564)	Bluetooth ID	<div style="display: flex; justify-content: space-between; font-size: 0.8em; font-weight: bold;"> V/f CL-V/f OLV CLV AOLV OLV/PM AOLV/PM CLV/PM EZOLV </div> Sets the password necessary to use Bluetooth to control the drive with a smartphone or tablet.	- (0000 - 9999)

◆ A2: User Parameters

You can register frequently used parameters and recently changed parameters here to access them quickly. You can show the registered parameters in [User Custom Parameters] in the main menu.

■ A2-01 to A2-32: User Parameters 1 to 32

No. (Hex.)	Name	Description	Default (Range)
A2-01 to A2-32 (0106 - 0125)	User Parameters 1 to 32	<div style="display: flex; justify-content: space-between; font-size: 0.8em; font-weight: bold;"> V/f CL-V/f OLV CLV AOLV OLV/PM AOLV/PM CLV/PM EZOLV </div> You can select a maximum of 32 parameters for the drive and set them to parameters <i>A2-01 to A2-32</i> . The [User Parameters] section of the keypad main menu shows the set parameters. You can immediately access these set parameters.	Parameters in General-Purpose Setup Mode (Determined by A1-06)

Note:

- Settings for *A2-01 to A2-32* change when the *A1-06 [Application Preset]* value changes.
- You must set *A1-01 = 1 [Access Level Selection = User Parameters]* to access parameters *A2-01 to A2-32*.
- When *A1-07 = 1 or 2 [DriveWorksEZ Function Selection = DWEZ Enabled or Enabled/Disabled w/Digital Input]*, the drive saves *qx-xx [DriveWorksEZ Parameters]* to *A2-01 to A2-32*.

The drive saves these parameters to *A2-01 to A2-32*.

- The drive saves a maximum of 32 parameters.

Note:

Set *A1-01 = 2 [Advanced Level]* or *A1-01 = 3 [Expert Level]* to register the necessary parameters.

- The drive automatically saves changed parameters to *A2-17 to A2-32*.

Note:

Set *A2-33 = 1 [User Parameter Auto Selection = Enabled]*.

■ A2-33: User Parameter Auto Selection

No. (Hex.)	Name	Description	Default (Range)
A2-33 (0126)	User Parameter Auto Selection	<div style="display: flex; justify-content: space-between; font-size: 0.8em; font-weight: bold;"> V/f CL-V/f OLV CLV AOLV OLV/PM AOLV/PM CLV/PM EZOLV </div> Sets the automatic save feature for changes to parameters <i>A2-17 to A2-32 [User Parameters 17 to 32]</i> .	Determined by A1-06 (0, 1)

0 : Disabled: Manual Entry Required

Set User Parameters manually.

1 : Enabled: Auto Save Recent Parm

The drive automatically registers changed parameter *A2-17 to A2-32*. The drive automatically saves the most recently changed parameter to *A2-17*, and saves a maximum of 16 parameters. After the drive registers 16 parameters, when you save a new parameter, the drive will remove a parameter from the User Parameter list to make space for the new parameter. The drive removes parameters with First In, First Out.

You can show the registered parameters in [User Custom Parameters] in the main menu.

Note:

In General-Purpose Setup Mode, the drive registers parameters starting with *A2-27* because the drive registers parameters *A2-26* and lower by default.

12.3 b: Application

b parameters set the following functions.

- Frequency reference source/Run command source
- Stopping method settings
- DC Injection Braking
- Speed Search
- Timer Function
- PID control
- Dwell function
- Droop control
- Energy Savings Control
- Zero Servo Control

◆ b1: Operation Mode Selection

b1 parameters set the operation mode for the drive.

■ b1-01: Frequency Reference Selection 1

No. (Hex.)	Name	Description	Default (Setting Range)
b1-01 (0180)	Frequency Reference Selection 1	 Sets the input method for the frequency reference.	1 (0 - 4)

Note:

- Push on the keypad to set the input mode to LOCAL and enter the frequency reference from the keypad.
- When the drive receives a Run command when the frequency reference is 0 Hz or less than the *E1-09* [Minimum Output Frequency] value, on the keypad will flash. Examine the setting for the frequency reference input and enter a value \geq E1-09.

0 : Keypad

Use the keypad to enter the frequency reference.

Use and on the keypad to change the frequency reference.

1 : Analog Input

Use MFAI terminals A1, A2, and A3 to input an analog frequency reference with a voltage or current input signal.

- Voltage Input
 Refer to [Table 12.18](#) to use a voltage signal input to one of the MFAI terminals.

Table 12.18 Frequency Reference Voltage Input

Terminal	Terminal Signal Level	Parameter Settings				Note
		Signal Level Selection	Function Selection	Gain	Bias	
A1	0 - 10 V	H3-01 = 0	H3-02 = 0 [Frequency Bias]	H3-03	H3-04	Set DIP switch S1-1 to "V" for voltage input.
	-10 - +10 V	H3-01 = 1				
A2	0 - 10 V	H3-09 = 0	H3-10 = 0 [Frequency Bias]	H3-11	H3-12	Set DIP switch S1-2 to "V" for voltage input.
	-10 - +10 V	H3-09 = 1				
A3	0 - 10 V	H3-05 = 0	H3-06 = 0 [Frequency Bias]	H3-07	H3-08	Set DIP switch S1-3 to "V" for voltage input. Set DIP switch S4 to "AI" for analog input.
	-10 - +10 V	H3-05 = 1				

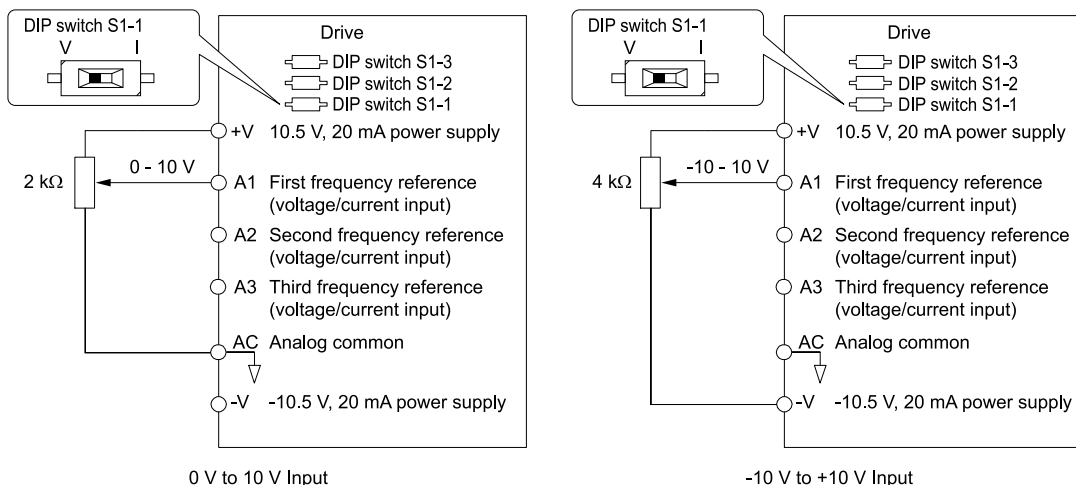

Figure 12.8 Example of Setting the Frequency Reference with a Voltage Signal to Terminal A1

Note:

You can also use this diagram to wire terminals A2 and A3.

• **Current Input**

Refer to [Table 12.19](#) to use a current signal input to one of the MFAI terminals.

Table 12.19 Frequency Reference Current Input

Terminal	Signal Level	Parameter Settings				Note
		Signal Level Selection	Function Selection	Gain	Bias	
A1	4 mA to 20 mA	H3-01 = 2	H3-02 = 0 [Frequency Bias]	H3-03	H3-04	Set DIP switch S1-1 to "I" for current input.
	0 - 20 mA	H3-01 = 3				
A2	4 mA to 20 mA	H3-09 = 2	H3-10 = 0 [Frequency Bias]	H3-11	H3-12	
	0 - 20 mA	H3-09 = 3				
A3	4 mA to 20 mA	H3-05 = 2	H3-06 = 0 [Frequency Bias]	H3-07	H3-08	Set DIP switch S1-3 to "I" for current input. Set DIP switch S4 to "AI" for analog input.
	0 - 20 mA	H3-05 = 3				

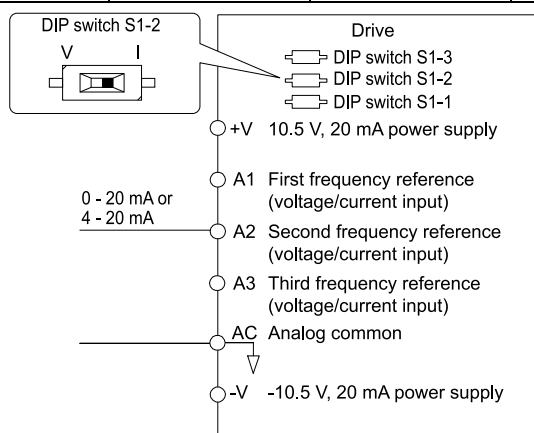

Figure 12.9 Example of Setting the Frequency Reference with a Current Signal to Terminal A2

Note:

You can also use this diagram to wire terminals A1 and A3.

Changing between Master and Auxiliary Frequency References

Use the multi-step speed reference function to change the frequency reference input between terminals A1, A2, and A3.

2 : Memobus/Modbus Communications

Use MEMOBUS/Modbus communications to enter the frequency reference.

3 : Option PCB

Use a communications option card or input option card connected to the drive to enter the Run command. Refer to the instruction manual included with the option card to install and set the option card.

Note:









If $b1-01 = 3$ but no connected option card, then *oPE05 [Run Cmd/Freq Ref Source Sel Err]* will flash on the keypad.

4 : Pulse Train Input

Use a pulse train signal from the pulse train input terminal RP to enter the frequency reference. Do this procedure to make sure that the pulse train signal is operating correctly.

1. Set $b1-01 = 4$, $H6-01 = 0$ [*Terminal RP Pulse Train Function = Frequency Reference*].
2. Set $H6-02$ [*Terminal RP Frequency Scaling*] to the number of pulses that determine 100% of the frequency reference.
3. Enter a pulse train signal on the terminal RP and make sure that the keypad shows a correct frequency reference.

■ b1-02: Run Command Selection 1

No. (Hex.)	Name	Description	Default (Range)
b1-02 (0181)	Run Command Selection 1	         Sets the input method for the Run command.	1 (0 - 3)

0 : Keypad

Use the keypad to enter the Run command. You can use the JOG operation or the FWD/REV commands from the keypad.

Note:

The  on the keypad is on while keypad is the Run command source.

1 : Digital Input

Use the control circuit terminals to enter the Run command. Select the input method for the Run command with an *H1-xx* parameter.

Set $H1-xx = 0, 40$ to 43 [*3-Wire Sequence, Run Command (2-Wire Sequence)*]. The default setting is 2-wire sequence 1.

- 2-wire Sequence 1
This sequence has two input types: FWD/Stop and REV/Stop. Set $A1-03 = 2220$ [*Initialize Parameters = 2-Wire Initialization*] to initialize the drive and set terminals S1 and S2 for a 2-wire sequence.
- 2-wire Sequence 2
This sequence has two input types: Run/Stop and FWD/REV.
- 3-Wire Sequence
This sequence has three input types: Run, Stop, and FWD/REV. Set $A1-03 = 3330$ [*Initialize Parameters = 3-Wire Initialization*] to initialize the drive and set terminals S1, S2, and S5 for a 3-wire sequence.

2 : Memobus/Modbus Communications

Use MEMOBUS/Modbus communications to enter the Run command.

3 : Option PCB

Use a communications option card or input option card connected to the drive to enter the Run command. Refer to the instruction manual included with the option card to install and set the option card.

Note:

If $b1-02 = 3$ but no connected option card, then *oPE05 [Run Cmd/Freq Ref Source Sel Err]* will flash on the keypad.

■ b1-03: Stopping Method Selection

No. (Hex.)	Name	Description	Default (Range)
b1-03 (0182)	Stopping Method Selection	V/f CL-V/f OLV CLV AOLV OLV/PM AOLV/PM CLV/PM EZOLV Sets the method to stop the motor after removing a Run command or entering a Stop command.	0 (0 - 3)

Note:

When $A1-02 = 3, 4, 5, 6, 7, 8$ [Control Method Selection = CLV, AOLV, OLV/PM, AOLV/PM, CLV/PM, EZOLV], the setting range is 0, 1, 3.

Select the applicable stopping method for the application from these four options:

0 : Ramp to Stop

When you enter the Stop command or turn OFF the Run command, the drive ramps the motor to stop.

The drive ramps the motor to stop as specified by the deceleration time. The default setting for the deceleration time is $C1-02$ [Deceleration Time 1]. The actual deceleration time changes as the load conditions change (for example, mechanical loss and inertia).

If the output frequency is less than or equal to the value set in $b2-01$ [DC Injection/Zero SpeedThreshold] during deceleration, the drive will do DC Injection Braking, Zero Speed Control, or Short Circuit Braking, as specified by the control method.

• Ramp to Stop with V/f, AOLV, CL-V/f, and OLV Control Methods

Parameter $b2-01$ sets the frequency to start DC Injection Braking at stop. If the output frequency is less than or equal to the value set in $b2-01$ during deceleration, then the drive will perform DC Injection Braking for the time set in $b2-04$ [DC Inject Braking Time at Stop].

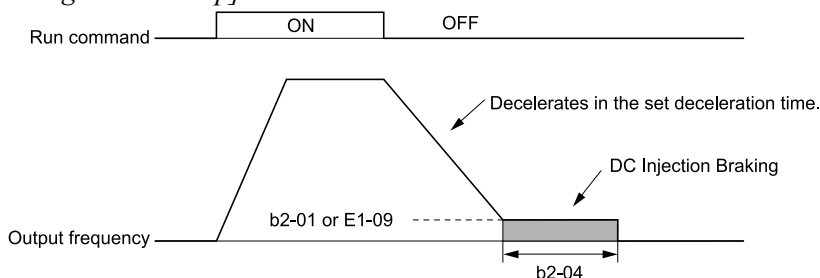

Figure 12.10 Ramp to Stop with V/f, AOLV, CL-V/f, and OLV Control Methods

Note:

When $b2-01 \leq E1-09$ [Minimum Output Frequency], the drive will start DC Injection Braking from the frequency set in $E1-09$.

• Ramp to Stop with OLV/PM, AOLV/PM, and EZOLV Control Methods

Parameter $b2-01$ sets the frequency to start Short Circuit Braking. When the output frequency is less than or equal to the value set in $b2-01$ during deceleration, then the drive will do Short Circuit Braking for the time set in $b2-13$ [Short Circuit Brake Time @ Stop]. When $b2-04 \neq 0$, the drive will do DC Injection Braking for the time set in $b2-04$ when Short Circuit Braking is complete.

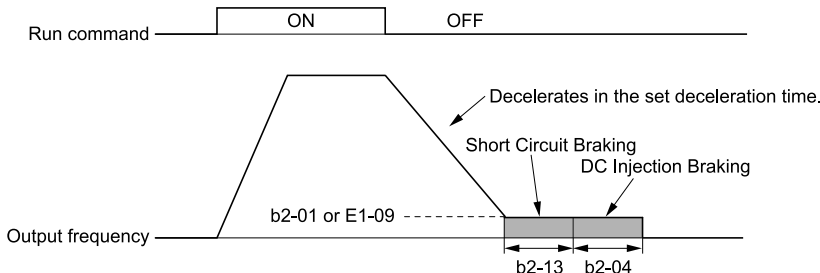

Figure 12.11 Ramp to Stop with OLV/PM, AOLV/PM, and EZOLV Control Methods

Note:

When $b2-01 \leq E1-09$, the drive will start Short Circuit Braking from the frequency set in $E1-09$.

If $b2-01 = 0$ Hz and $E1-09 = 0$ Hz, the drive will not do Short Circuit Braking.

• Ramp to Stop in CLV and CLV/PM Control Methods

Parameter *b2-01* sets the frequency to start Zero Speed Control at stop. When the output frequency is less than or equal to the value set in *b2-01* during deceleration, the drive will do Zero Speed Control for the time set in *b2-04*.

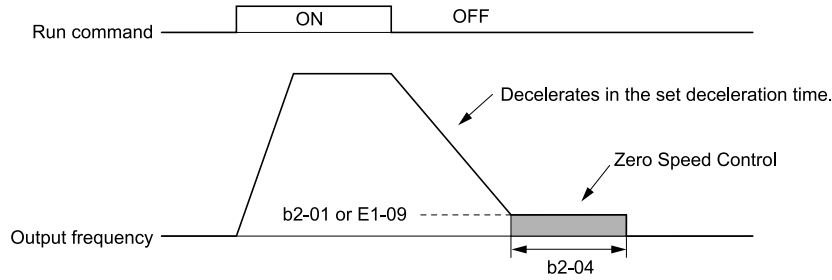

Figure 12.12 Ramp to Stop in CLV and CLV/PM Control Methods

Note:

When $b2-01 \leq E1-09$, the drive will start Zero Speed Control from the frequency set in *E1-09*.

1 : Coast to Stop

When you enter the Stop command or turn OFF the Run command, the drive turns OFF the output and coasts the motor to stop.

Load conditions will have an effect on the deceleration rate as the motor coasts to stop (for example, mechanical loss and inertia).

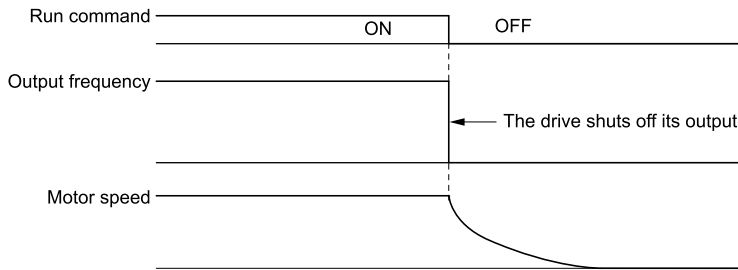

Figure 12.13 Coast to Stop

Note:

The drive ignores the Run command for the time set in *L2-03* [Minimum Baseblock Time] when the Stop command is entered or when the Run command is switched OFF. Do not enter the Run command until the motor comes to a complete stop. Use DC Injection or Speed Search to restart the motor before it stops.

2 : DC Injection Braking to Stop

When you enter the Stop command or turn OFF the Run command, the drive turns OFF the output for the time set in *L2-03*. The drive waits for the minimum baseblock time and then injects the amount of DC current into the motor set in *b2-02* [DC Injection Braking Current] to stop the motor with DC current.

DC Injection Braking stops the motor more quickly than coast to stop.

Note:

If $A1-02 = 3, 4, 5, 6, \text{ or } 7$, DC Injection Braking to Stop is not available.

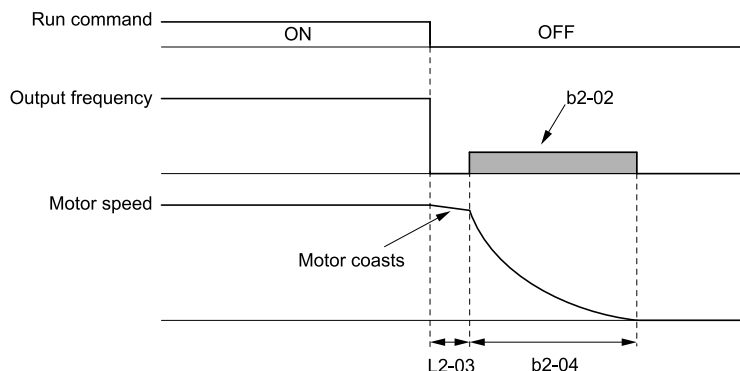

Figure 12.14 DC Injection Braking to Stop

The value set in *b2-04* and the output frequency when the drive receives the Stop command determine the DC Injection Braking time. The drive calculates the DC Injection Braking time as in [Figure 12.15](#).

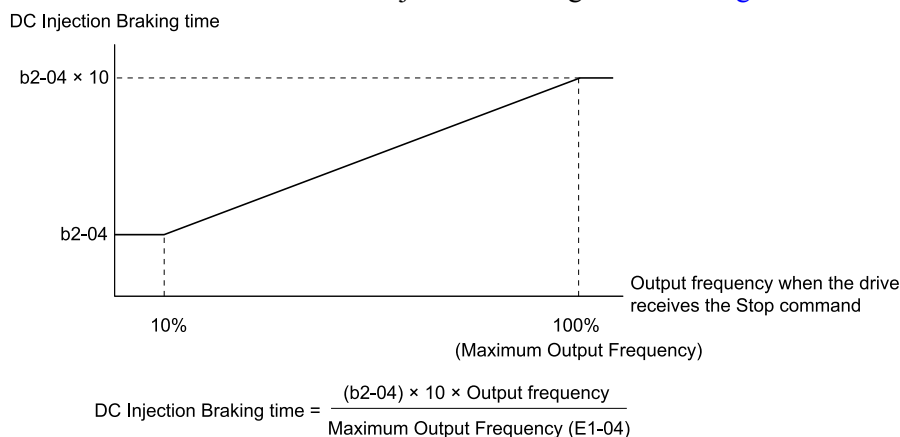

Figure 12.15 DC Injection Braking Time and Output Frequency

Note:

If the drive detects *oC* [Overcurrent] when it uses DC Injection Braking to stop the motor, set *L2-03* to a high value that will not trigger *oC*.

3 : Coast to Stop with Timer

When you enter the Stop command or turn OFF the Run command, the drive turns OFF the output and coasts the motor to stop. The drive ignores the Run command until the “Run wait time *t*” is expired.

To start the drive again, enter the Run command after the “Run wait time *t*” is expired.

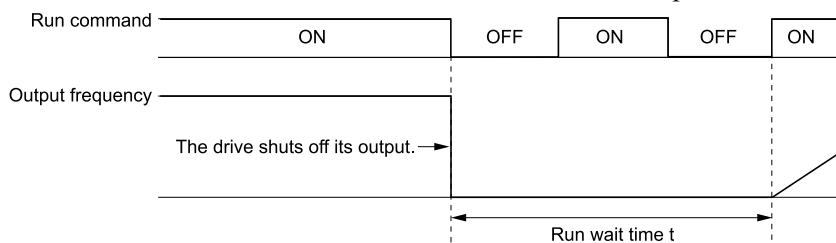

Figure 12.16 Coast to Stop with Timer

The active deceleration time and the output frequency when drive receives the Stop command determine the length of “Run wait time *t*”.

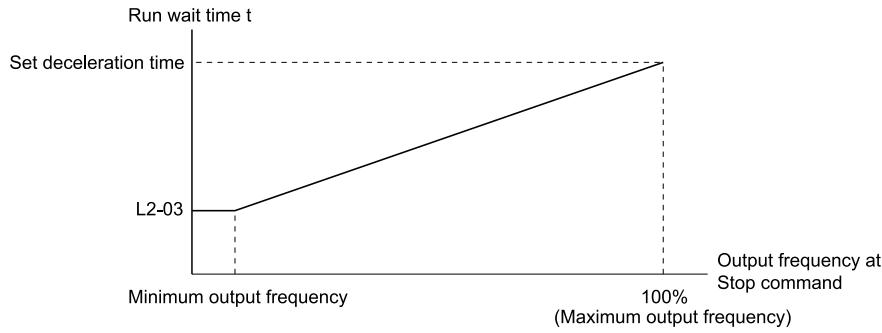

Figure 12.17 Run Wait Time and Output Frequency

■ **b1-04: Reverse Operation Selection**

No. (Hex.)	Name	Description	Default (Range)
b1-04 (0183)	Reverse Operation Selection	<input type="checkbox"/> V/f <input type="checkbox"/> CL-V/f <input type="checkbox"/> OLV <input type="checkbox"/> CLV <input type="checkbox"/> AOLV <input type="checkbox"/> OLV/PM <input type="checkbox"/> AOLV/PM <input type="checkbox"/> CLV/PM <input type="checkbox"/> EZOLV Sets the reverse operation function. Disable reverse operation in fan or pump applications where reverse rotation is dangerous.	0 (0, 1)

When reverse operation is prohibited, the drive will not accept a Reverse operation command.

0 : Reverse Enabled

The drive will accept a Reverse operation command.

1 : Reverse Disabled

The drive will not accept a Reverse operation command.

■ **b1-05: Operation Below Minimum Freq**

No. (Hex.)	Name	Description	Default (Range)
b1-05 (0184)	Operation Below Minimum Freq	<input type="checkbox"/> V/f <input type="checkbox"/> CL-V/f <input type="checkbox"/> OLV <input checked="" type="checkbox"/> CLV <input type="checkbox"/> AOLV <input type="checkbox"/> OLV/PM <input type="checkbox"/> AOLV/PM <input type="checkbox"/> CLV/PM <input type="checkbox"/> EZOLV Sets the drive operation when the frequency reference decreases to less than the value set in E1-09 [Minimum Output Frequency].	0 (0 - 3)

0 : Operate at Frequency Reference

When the frequency reference is less than the value set in E1-09, the drive will continue to operate the motor as specified by the frequency reference.

If the motor speed is less than or equal to the value set in b2-01 [DC Injection/Zero SpeedThreshold] when you enter the Stop command (or deactivate the Run command), the drive will do Zero Speed Control for the time set in b2-04 [DC Inject Braking Time at Stop] and then turn OFF its output.

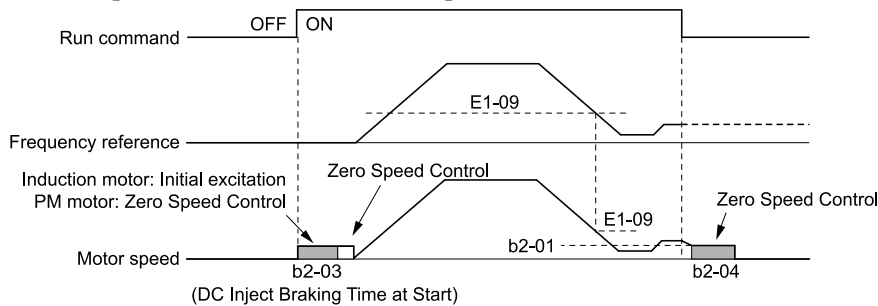

Figure 12.18 Operate at the Frequency Reference

1 : Baseblock (Motor Coasts)

If the frequency reference is less than the value set in E1-09, the drive stops motor voltage output and the motor coasts to stop. If the motor speed is less than or equal to the value set in b2-01, the drive will do Zero Speed Control for the time set in b2-04.

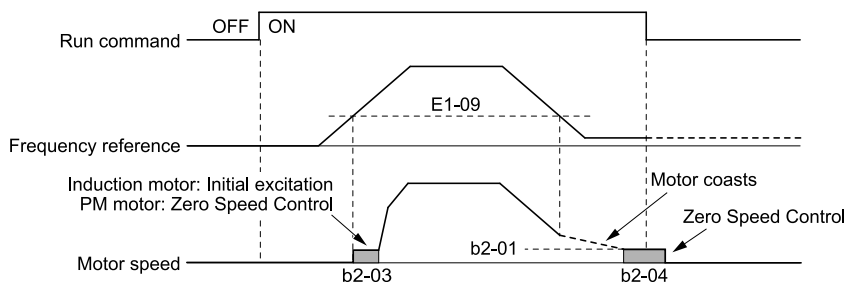

Figure 12.19 Coast to Stop

2 : Operate at Minimum Frequency

The drive operates the motor at the minimum frequency reference set in *E1-09* when the frequency reference falls below the value set in *E1-09* and the Run command is still enabled.

The drive decelerates the motor when the Stop command is entered (or when the Run command is switched OFF). If the motor speed falls below or is equal to the value set in *b2-01*, then the drive will perform Zero Speed Control for the time set in *b2-04*.

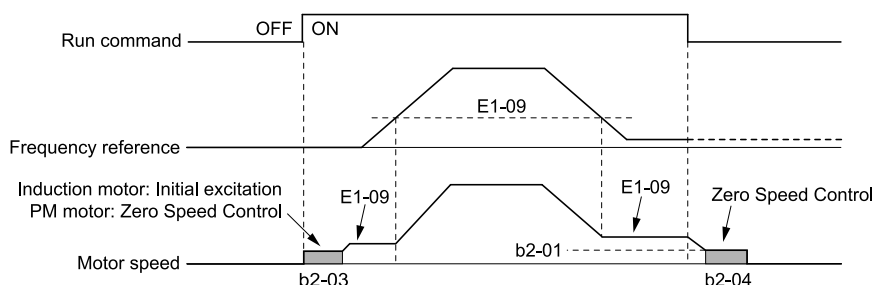

Figure 12.20 Operate at Minimum Frequency

3 : Operate at Zero Speed

The drive performs Zero Speed Control when the frequency reference falls below the value set in *E1-09*.

When you enter the Stop command (or when you turn OFF the Run command), the drive does Zero Speed Control again for the time set in *b2-04*.

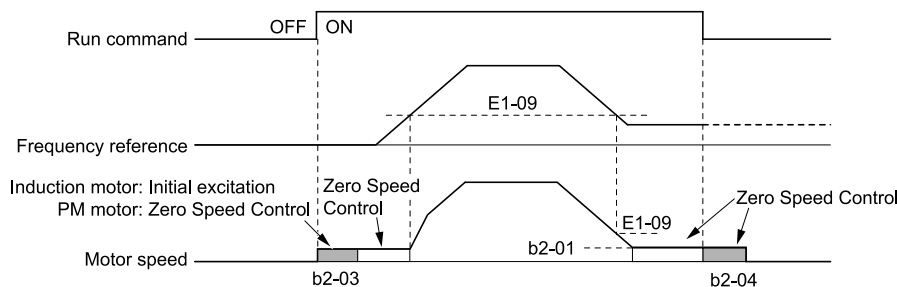

Figure 12.21 Operate at Zero Speed

■ b1-06: Digital Input Reading

No. (Hex.)	Name	Description	Default (Range)
b1-06 (0185)	Digital Input Reading	V/f CL-V/f OLV CLV AOLV OLV/PM AOLV/PM CLV/PM EZOLV Sets the number of times that the drive reads the sequence input command to prevent malfunction because of noise.	1 (0, 1)

0 : Single Scan

The drive reads the terminal status one time. The drive immediately reads all changes to the terminal status. This setting lets the drive quickly respond to changes in the sequence, but noise can cause malfunction.

1 : Double Scan

12.3 b: Application

The drive reads the terminal status two times. The drive reads all changes to the terminal status two times to make sure that the reading is the same.

The drive responds slower than when it reads the sequence one time, but this setting prevents malfunction because of noise.

■ b1-07: LOCAL/REMOTE Run Selection

No. (Hex.)	Name	Description	Default (Range)
b1-07 (0186)	LOCAL/REMOTE Run Selection	<div style="display: flex; justify-content: space-between; font-size: 0.8em; font-weight: bold;"> V/f CL-V/f OLV CLV AOLV OLV/PM AOLV/PM CLV/PM EZOLV </div> <p>Sets drive response to an existing Run command when the drive receives a second Run command from a different location.</p>	0 (0, 1)

This parameter interlocks the drive to help prevent accidents that can occur if the motor starts to rotate because the Run command source changed.

To switch the RUN command source, push **LO/RE** on the keypad or set $H1-xx = 1, 2$ [*MFDI Function Selection = LOCAL/REMOTE Selection, External Reference 1/2 Selection*] and activate/deactivate the terminal.

0 : Disregard Existing RUN Command

If a Run command is enabled when you switch between Run command sources, the drive will not operate the motor. When the drive is operating the motor, turn OFF the Run command to stop the motor. Enter the Run command again to start operation.

1 : Accept Existing RUN Command

If a Run command is enabled when you switch between Run command sources, the drive will start to operate the motor or continue to operate the motor.

WARNING! Sudden Movement Hazard. When you use a 3-Wire sequence, set $A1-03 = 3330$ [*Initialize Parameters = 3-Wire Initialization*] and make sure that $b1-17 = 0$ [*Run Command at Power Up = Disregard Existing RUN Command*] (default). If you do not correctly set the drive parameters for 3-Wire operation before you energize the drive, the motor can suddenly rotate when you energize the drive.

■ b1-08: Run Command Select in PRG Mode

No. (Hex.)	Name	Description	Default (Range)
b1-08 (0187)	Run Command Select in PRG Mode	<div style="display: flex; justify-content: space-between; font-size: 0.8em; font-weight: bold;"> V/f CL-V/f OLV CLV AOLV OLV/PM AOLV/PM CLV/PM EZOLV </div> <p>Sets the conditions for the drive to accept a Run command entered from an external source when using the keypad to set parameters.</p>	0 (0 - 2)

As a safety precaution, when the drive is in Programming Mode, it will not respond to a Run command.

This parameter helps prevent accidents that can occur if the motor starts to rotate because the drive received a Run command from an external source while the user is programming the drive. You can also set the drive to not show the Programming Mode when a Run command is active.

Note:

Refer to this table for Drive Mode and Programming Mode functions.

Mode	Keypad Screen	Function
Drive Mode	Monitors	Sets monitor display.
Programming Mode	Parameters	Changes parameter settings.
	User Custom Parameters	Shows the User Parameters.
	Parameter Backup/Restore	Saves parameters to the keypad as backup.
	Modified Parameters/Fault Log	Shows modified parameters and fault history.
	Auto-Tuning	Auto-Tunes the drive.
	Initial Setup	Changes initial settings.
	Diagnostic Tools	Sets data logs and backlight.

0 : Disregard RUN while Programming

The drive rejects the Run command while in Programming Mode.

1 : Accept RUN while Programming

The drive accepts a Run command entered from an external source while in Programming Mode.

2 : Allow Programming Only at Stop

The drive does not let the user enter Programming Mode when the drive is operating. The drive does not show the Programming Mode when a Run command is active.

■ b1-09: LOCAL/REMOTE Select during RUN

No. (Hex.)	Name	Description	Default (Range)
b1-09 (0188) Expert	LOCAL/REMOTE Select during RUN	<p>Sets the function that lets you use the during operation to switch between LOCAL and REMOTE Modes.</p>	0 (0, 1)

0 : Disabled

1 : Enabled

When you switch the operation mode from REMOTE to LOCAL during run, the drive writes this REMOTE operation status to the keypad:

- Frequency reference during run
- RUN/STOP status of the keypad
- FWD/REV
- JOG

Note:

When b1-09 = 1, the drive will detect *oPE05 [Run Cmd/Freq Ref Source Sel Err]* if you set one of these parameter values:

- b1-02 = 0 [Run Command Selection 1 = Keypad]
- b1-16 = 0 [Run Command Selection 2 = Keypad] and H1-xx = 2 [MFDI Function Selection = External Reference 1/2 Selection]
- H1-xx = 3 to 6, 12, 13, 32 [Multi-Step Speed Reference 1 to 4, Jog Reference Selection, Forward Jog, Reverse Jog]

■ b1-14: Phase Order Selection

No. (Hex.)	Name	Description	Default (Range)
b1-14 (01C3)	Phase Order Selection	<p>Sets the phase order for output terminals U/T1, V/T2, and W/T3. This parameter can align the Forward Run command from the drive and the forward direction of the motor without changing wiring.</p>	0 (0, 1)

0 : Standard

1 : Switch Phase Order

■ b1-15: Frequency Reference Selection 2

No. (Hex.)	Name	Description	Default (Range)
b1-15 (01C4)	Frequency Reference Selection 2	<p>Sets the input method for frequency reference 2.</p>	0 (0 - 4)

This parameter is enabled when *H1-xx = 2 [MFDI Function Selection = External Reference 1/2 Selection]* is activated.

Note:

- Push on the keypad to set the input mode to LOCAL and enter the frequency reference from the keypad.

- If the frequency reference is 0 Hz or $\leq E1-09$ [Minimum Output Frequency] and the drive receives a Run command, the on the keypad will flash. Check the setting for the frequency reference input and enter a value more than or equal to *E1-09*.

0 : Keypad

Use the keypad to enter the frequency reference.

Use and on the keypad to change the frequency reference.

1 : Analog Input

Use MFAI terminals A1, A2, and A3 to input an analog frequency reference with a voltage or current input signal.

• **Voltage Input**

Refer to [Table 12.20](#) to use a voltage signal input to one of the MFAI terminals.

Table 12.20 Frequency Reference Voltage Input

Terminal	Terminal Signal Level	Parameter Settings				Note
		Signal Level Selection	Function Selection	Gain	Bias	
A1	0 - 10 V	H3-01 = 0	H3-02 = 0 [Frequency Reference]	H3-03	H3-04	Set DIP switch S1-1 to "V" for voltage input.
	-10 - +10 V	H3-01 = 1				
A2	0 - 10 V	H3-09 = 0	H3-10 = 0 [Frequency Reference]	H3-11	H3-12	Set DIP switch S1-2 to "V" for voltage input.
	-10 - +10 V	H3-09 = 1				
A3	0 - 10 V	H3-05 = 0	H3-06 = 0 [Frequency Reference]	H3-07	H3-08	Set DIP switch S1-3 to "V" for voltage input. Set DIP switch S4 to "AI" for analog input.
	-10 - +10 V	H3-05 = 1				

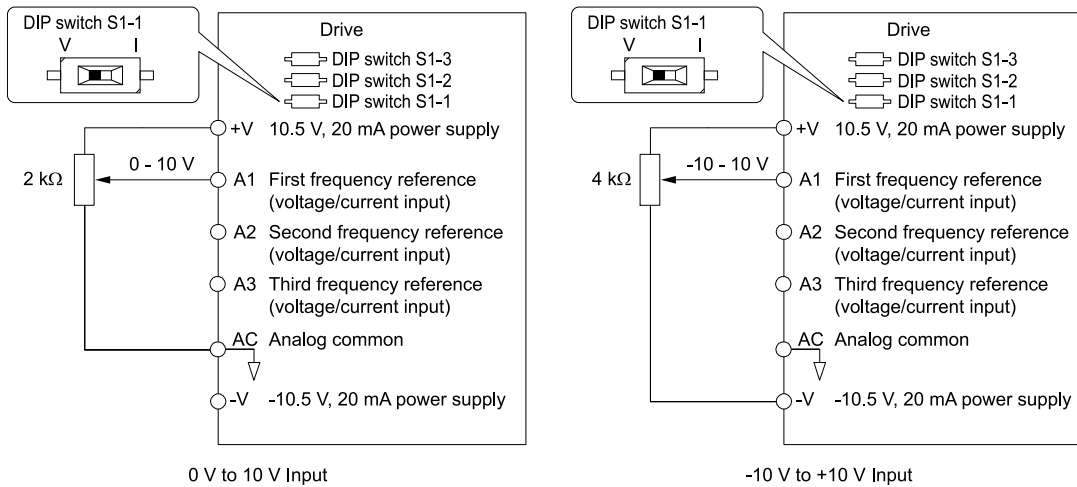

Figure 12.22 Example of Setting the Frequency Reference with a Voltage Signal to Terminal A1

Note:

You can also use this diagram to wire terminals A2 and A3.

• **Current Input**

Refer to [Table 12.21](#) to use a voltage signal input to one of the MFAI terminals.

Table 12.21 Frequency Reference Current Input

Terminal	Signal Level	Parameter Settings				Note
		Signal Level Selection	Function Selection	Gain	Bias	
A1	4 mA to 20 mA	H3-01 = 2	H3-02 = 0 [Frequency Reference]	H3-03	H3-04	Set DIP switch S1-1 to "I" for current input.
	0 - 20 mA	H3-01 = 3				
A2	4 mA to 20 mA	H3-09 = 2	H3-10 = 0 [Frequency Reference]	H3-11	H3-12	Set DIP switch S1-2 to "I" for current input.
	0 - 20 mA	H3-09 = 3				
A3	4 mA to 20 mA	H3-05 = 2	H3-06 = 0 [Frequency Reference]	H3-07	H3-08	Set DIP switch S1-3 to "I" for current input. Set DIP switch S4 to "AI" for analog input.
	0 - 20 mA	H3-05 = 3				

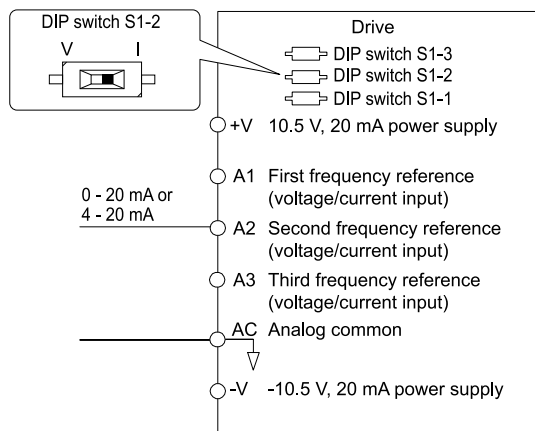

Figure 12.23 Example of Setting the Frequency Reference with a Current Signal to Terminal A2

Note:

You can also use this diagram to wire terminals A1 and A3.

Changing between Master and Auxiliary Frequency References

Use the multi-step speed reference function to change the frequency reference input between terminals A1, A2, and A3.

2 : Memobus/Modbus Communications

Use MEMOBUS/Modbus communications to enter the frequency reference.

3 : Option PCB

Use a communications option card or input option card connected to the drive to enter the Run command.

Refer to the instruction manual included with the option card to install and set the option card.

Note:

If $b1-15 = 3$ but no option card is connected, then $oPE03$ [Multi-Function Input Setting Err] will flash on the keypad.

4 : Pulse Train Input

Use a pulse train signal from the pulse train input terminal RP to enter the frequency reference.

Do this procedure to make sure that the pulse train signal is operating correctly.

1. Set $b1-15 = 4$, $H6-01 = 0$ [Terminal RP Pulse Train Function = Frequency Reference].
2. Set $H6-02$ [Terminal RP Frequency Scaling] to the number of pulses that determine 100% of the frequency reference.
3. The terminal assigned to $H1-xx = 2$ [MFDI Function Selection = External Reference 1/2 Selection] is activated.
4. Enter a pulse train signal on the terminal RP and make sure that the keypad shows a correct frequency reference.

■ b1-16: Run Command Selection 2

No. (Hex.)	Name	Description	Default (Range)
b1-16 (01C5)	Run Command Selection 2	<input type="checkbox"/> V/f <input type="checkbox"/> CL-V/f <input type="checkbox"/> OLV <input type="checkbox"/> CLV <input type="checkbox"/> AOLV <input type="checkbox"/> OL/PM <input type="checkbox"/> AOL/PM <input type="checkbox"/> CL/PM <input type="checkbox"/> EZOLV	0 (0 - 3)

Activate $H1-xx = 2$ [MFDI Function Selection = External Reference 1/2 Selection] to enable this parameter.

0 : Keypad

Use the keypad to enter the Run command.

You can use the JOG operation or the FWD/REV commands from the keypad.

Note:

The  is on while the keypad is the Run command source.

1 : Digital Input

12.3 b: Application

Use the control circuit terminals to enter the Run command. Select the input method for the Run command with an *H1-xx* parameter.

Set *H1-xx* = 0, 40 to 43 [*3-Wire Sequence, Run Command (2-Wire Sequence)*]. The default setting is 2-wire sequence 1.

- 2-wire Sequence 1
This sequence has two input types: FWD/Stop and REV/Stop. Set *A1-03* = 2220 [*Initialize Parameters = 2-Wire Initialization*] to initialize the drive and set terminals S1 and S2 for a 2-wire sequence.
- 2-wire Sequence 2
This sequence has two input types: Run/Stop and FWD/REV.
- 3-Wire Sequence
This sequence has three input types: Run, Stop, and FWD/REV. Set *A1-03* = 3330 [*Initialize Parameters = 3-Wire Initialization*] to initialize the drive and set terminals S1, S2, and S5 for a 3-wire sequence.

2 : Memobus/Modbus Communications

Use MEMOBUS/Modbus communications to enter the Run command.

3 : Option PCB

Use a communications option card or input option card connected to the drive to enter the Run command.

Refer to the instruction manual included with the option card to install and set the option card.

Note:

If *b1-16* = 3 but no option card is connected, then *oPE03* [*Multi-Function Input Setting Err*] will flash on the keypad.

■ b1-17: Run Command at Power Up

No. (Hex.)	Name	Description	Default (Range)
b1-17 (01C6)	Run Command at Power Up	 Sets drive response when energizing a drive that has an external Run command. Set this parameter in applications where energizing or de-energizing the drive enables the Run command.	0 (0, 1)

0 : Disregard Existing RUN Command

The drive does not start to operate the application when the power is switched ON, even when there is an existing Run command.

Enter the Run command again to operate the application.

Note:

When you energize the drive,  on the keypad will flash quickly if the Run command is already enabled from an external source.

1 : Accept Existing RUN Command

When there is an existing Run command, the drive starts to operate the application when the power is switched ON.

WARNING! *Sudden Movement Hazard.* When you use a 3-Wire sequence, set *A1-03* = 3330 [*Initialize Parameters = 3-Wire Initialization*] and make sure that *b1-17* = 0 [*Run Command at Power Up = Disregard Existing RUN Command*] (default). If you do not correctly set the drive parameters for 3-Wire operation before you energize the drive, the motor can suddenly rotate when you energize the drive.

■ b1-21: CLV Start Selection

No. (Hex.)	Name	Description	Default (Range)
b1-21 (0748) Expert	CLV Start Selection	 Sets the conditions for the drive to accept a Run command when <i>A1-02</i> = 3, 7 [<i>Control Method Selection = CLV, CLV/PM</i>]. Usually it is not necessary to change this setting.	0 (0, 1)

0 : Reject RUN if b2-01<U1-05<E1-09

If the motor speed $\geq b2-01$ or the motor speed $< E1-09$, the drive will not accept a Run command.

1 : Accept RUN Command at Any Speed

If the motor speed $\geq b2-01$ or the motor speed $< E1-09$, the drive will accept a Run command.

■ b1-35: Digital Input Deadband Time

No. (Hex.)	Name	Description	Default (Range)
b1-35 (1117) Expert	Digital Input Deadband Time	V/f CL-V/f OLV CLV AOLV OLV/PM AOLV/PM CLV/PM EZOLV Sets the deadband time for MFDIs.	0.0 ms (0.0 to 100.0 ms)

When the on/off time for MFDIs is longer than the time set in *b1-35*, the drive activates the MFDI. Set this parameter to prevent malfunctions caused by relay chattering for applications in which relays send input to MFDI terminals.

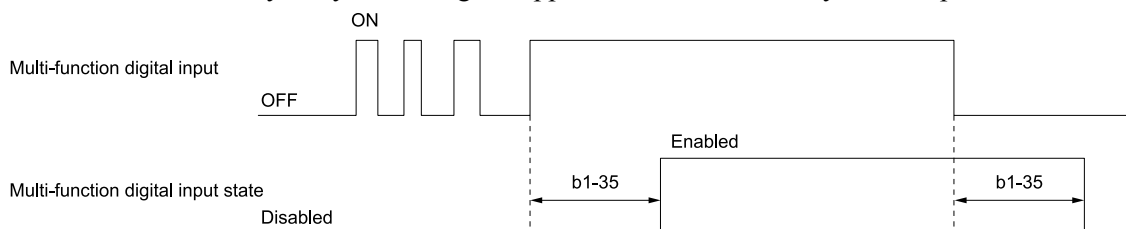

◆ b2: DC Injection Braking and Short Circuit Braking

b2 parameters set the DC Injection Braking and Short Circuit Braking functions.

- DC Injection Braking: A braking method that injects DC current into the motor windings. This function should not be used too frequently, because it generates a fair amount of heat in the motor.
- Short Circuit Braking: A braking method for PM motors.

■ b2-01: DC Injection/Zero SpeedThreshold

No. (Hex.)	Name	Description	Default (Range)
b2-01 (0189)	DC Injection/Zero SpeedThreshold	V/f CL-V/f OLV CLV AOLV OLV/PM AOLV/PM CLV/PM EZOLV Sets the frequency to start DC Injection Braking, Short Circuit Braking, and Zero Servo.	Determined by A1-02 (0.0 - 10.0 Hz)

Note:

This parameter is available when *b1-03* = 0 [Stopping Method Selection = Ramp to Stop].

When the control method selected in *A1-02* [Control Method Selection] changes, the *b2-01* function changes.

12.3 b: Application

Parameter Settings	Function of b2-01
<p>$A1-02 = 0, 1, 2$ [V/f, CL-V/f, OLV]</p> <p>$A1-02 = 4$ [AOLV] and $n4-72 = 0$ [Speed Feedback Mode = Without Encoder]</p>	<p>$b2-01$ sets the frequency to start DC Injection Braking at stop. When the output frequency is less than or equal to the value set in $b2-01$, the drive will inject the quantity of DC current set in $b2-02$ [DC Injection Braking Current] into the motor for the time set in $b2-04$ [DC Inject Braking Time at Stop].</p> <p>Figure 12.24 DC Injection Braking at Stop</p> <p>Note: When $b2-01 \leq E1-09$ [Minimum Output Frequency], the drive will start DC Injection Braking from the frequency set in $E1-09$.</p>
<p>$A1-02 = 5, 6, 8$ [OLV/PM, AOLV/PM, EZOLV]</p>	<p>$b2-01$ sets the frequency to start Short Circuit Braking at stop. When the output frequency is less than or equal to the value set in $b2-01$, the drive will do Short Circuit Braking for the time set in $b2-13$ [Short Circuit Brake Time @ Stop]. When $b2-04 > 0.00$ s, the drive will complete Short Circuit Braking, then do DC Injection Braking for the time set in $b2-04$.</p> <p>Figure 12.25 Short Circuit Braking at Stop</p> <p>Note: When $b2-01 \leq E1-09$, the drive will start Short Circuit Braking from the frequency set in $E1-09$. If $b2-01$ and $E1-09 = 0$ Hz, the drive will not do Short Circuit Braking.</p>
<p>$A1-02 = 3, 7$ [CLV, CLV/PM]</p> <p>$A1-02 = 4$ [AOLV] and $n4-72 = 1$ [With Encoder]</p>	<p>$b2-01$ sets the frequency to start Zero Speed Control at stop. When the output frequency is less than or equal to the value set in $b2-01$, the drive will do Zero Speed Control for the time set in $b2-04$.</p> <p>Figure 12.26 Zero Speed Control at Stop</p> <p>Note: When $b2-01 \leq E1-09$, the drive will start Zero Speed Control from the frequency set in $E1-09$.</p>

■ b2-02: DC Injection Braking Current

No. (Hex.)	Name	Description	Default (Range)
b2-02 (018A)	DC Injection Braking Current	<p>V/f CL-V/f OLV CLV AOLV QLV/PM AOLV/PM CLV/PM EZOLV</p> <p>Sets the DC Injection Braking current as a percentage of the drive rated current.</p>	50% (0 - 100%)

When the DC Injection Braking current is more than 50%, the drive decreases the carrier frequency to 1 kHz. The motor rated current determines how much DC Injection Braking current that the drive can use.

The DC Injection Braking current level has an effect on the strength of the magnetic field that locks the motor shaft. As the current level increases, the motor windings will supply more heat. Do not set this parameter higher than the level that is necessary to hold the motor shaft.

Note:

When $A1-02 = 4$ [Control Method Selection = AOLV] and $n4-72 = 1$ [Speed Feedback Mode = With Encoder], the drive ignores the $b2-02$ setting and does initial excitation.

■ b2-03: DC Inject Braking Time at Start

No. (Hex.)	Name	Description	Default (Range)
b2-03 (018B)	DC Inject Braking Time at Start	<p>V/f CL-V/f OLV CLV AOLV QLV/PM AOLV/PM CLV/PM EZOLV</p> <p>Sets the DC Injection Braking Time at stop. Sets the time of Zero Speed Control at start when $A1-02 = 3, 7$ [Control Method Selection = CLV, CLV/PM].</p>	<p>$A1-02 = 4$: 0.03 s</p> <p>Other than $A1-02 = 4$: 0.00 s (0.00 - 10.00 s)</p>

This function stops then restarts a coasting motor and increases motor flux to make high starting torque (a process called initial excitation). Set this parameter to 0.00 to disable the function.

Note:

- To restart a coasting motor, use DC Injection Braking to stop and then restart the motor, or enable Speed Search. Enable DC Injection Braking or Speed Search to prevent *ov* [Overvoltage] and *oC* [Overcurrent] faults.
- Sets the time of Initial Excitation at start when $A1-02 = 4$ [AOLV] and $n4-72 = 1$ [Speed Feedback Mode = With Encoder].

■ b2-04: DC Inject Braking Time at Stop

No. (Hex.)	Name	Description	Default (Range)
b2-04 (018C)	DC Inject Braking Time at Stop	V/f CL-V/f OLV CLV AOLV OLV/PM AOLV/PM CLV/PM EZOLV Sets the DC Injection Braking Time at stop. Sets the time of Zero Speed Control at stop when $A1-02 = 3, 7$ [Control Method Selection = CLV, CLV/PM].	Determined by A1-02 (0.00 - 10.00 s)

This function fully stops a motor with a large inertia during deceleration and will not let the inertia continue to rotate the motor.

Set this parameter to 0.00 to disable the function.

When a longer time is required to stop the motor, increase the value.

Note:

Sets the time of Zero Speed Control at stop when $A1-02 = 4$ [AOLV] and $n4-72 = 1$ [Speed Feedback Mode = With Encoder].

■ b2-08: Magnetic Flux Compensation Value

No. (Hex.)	Name	Description	Default (Range)
b2-08 (0190)	Magnetic Flux Compensation Value	V/f CL-V/f OLV CLV AOLV OLV/PM AOLV/PM CLV/PM EZOLV Sets how much current the drive injects when DC Injection Braking at Start starts (Initial Excitation) as a percentage of $E2-03$ [Motor No-Load Current].	0% (0 - 1000%)

This parameter is effective when you start a high-capacity motor (a motor with a large secondary circuit time constant). This function can quickly increase motor flux to make high starting torque (a process called initial excitation).

The current level for DC Injection Braking at start changes linearly from the setting of $b2-08$ to the setting of $b2-03$ as shown in Figure 12.27.

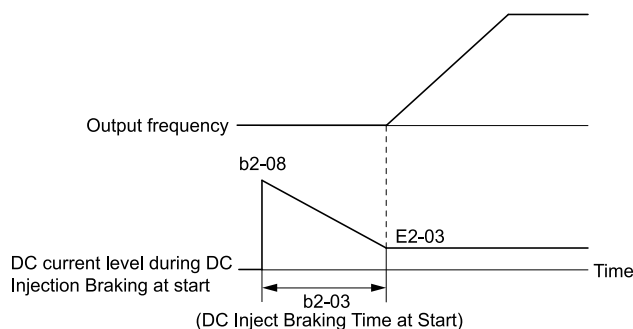

Figure 12.27 DC Current Level during DC Injection Braking at Start

Note:

- If $b2-08 < 100\%$, flux will develop very slowly.
- When $b2-08 = 0\%$, the DC current level will be the DC Injection current set in $b2-02$ [DC Injection Braking Current].
- If $b2-08$ is set too high, DC Injection Braking at start can cause a large noise. Adjust $b2-08$ to decrease the volume to the permitted level.

■ b2-12: Short Circuit Brake Time @ Start

No. (Hex.)	Name	Description	Default (Range)
b2-12 (01BA)	Short Circuit Brake Time @ Start	V/f CL-V/f OLV CLV AOLV OLV/PM AOLV/PM CLV/PM EZOLV Sets the Short Circuit Braking time at start.	0.00 s (0.00 - 25.50 s)

12.3 b: Application

This function stops and restarts a coasting PM motor. The drive short circuits all the three motor phases to make braking torque in the motor.

Set this parameter to 0.00 to disable the function.

Note:

- Short circuit Braking will let external forces rotate the PM motor. Use DC Injection Braking to prevent motor rotation from external forces.
- Motor speed and load conditions can make it necessary to install a dynamic braking option on the drive.

■ b2-13: Short Circuit Brake Time @ Stop

No. (Hex.)	Name	Description	Default (Range)
b2-13 (01BB)	Short Circuit Brake Time @ Stop	V/f CL-V/f OLV CLV AOLV OLV/PM AOLV/PM CLV/PM EZOLV Sets the Short Circuit Braking time at stop.	A1-02 = 8: 0.00 s Other than A1-02 = 8: 0.50 s (0.00 - 25.50 s)

This function fully stops a PM motor with a large inertia during deceleration and will not let the inertia continue to rotate the motor.

Short Circuit Braking operates for the time set in *b2-13* when output frequency is less than the value set in *b2-01* [DC Injection/Zero SpeedThreshold] or *E1-09* [Minimum Output Frequency].

Set this parameter to 0.00 to disable the function.

Note:

Motor speed and load conditions can make it necessary to install a dynamic braking option on the drive.

■ b2-18: Short Circuit Braking Current

No. (Hex.)	Name	Description	Default (Range)
b2-18 (0177)	Short Circuit Braking Current	V/f CL-V/f OLV CLV AOLV OLV/PM AOLV/PM CLV/PM EZOLV Sets the Short Circuit Braking Current as a percentage of the motor rated current.	100.0% (0.0 - 200.0%)

The Short Circuit Braking current cannot be higher than the drive rated current, although a higher current level can be set using *b2-18*. The maximum rated current is 120% when the drive is set for Normal Duty (*C6-01* = 1 [Normal Duty Rating]). The maximum rated current is 150% when the drive is set for Heavy Duty (*C6-01* = 0 [Heavy Duty Rating]).

◆ b3: Speed Search

The Speed Search function detects the actual speed of a coasting motor, then restarts the motor before the motor stops. Use Speed Search in these conditions:

- To continue operation after momentary power loss
- To switch from commercial power supply to drive power
- To restart a coasting fan

For example, the drive output turns off and the motor coasts when there is a momentary loss of power. After you return power, the drive does Speed Search on the coasting motor, and restarts the motor from the detected speed.

When you use a PM motor, enable *b3-01* [Speed Search at Start Selection].

There are two types of Speed Search for induction motors: Current Detection and Speed Estimation. Use parameter *b3-24* [Speed Search Method Selection] to select the type of Speed Search.

Parameter settings are different for different types of Speed Search. For details, refer to [Table 12.22](#).

Table 12.22 Speed Search and Related Parameters

Parameters	Speed Estimation	Current Detection 2
	b3-24 = 1	b3-24 = 2
b3-01 [Speed Search at Start Selection]	x	x
b3-03 [Speed Search Deceleration Time]	-	x
b3-05 [Speed Search Delay Time]	x	x

Parameters	Speed Estimation	Current Detection 2
	b3-24 = 1	b3-24 = 2
b3-06 [Speed Estimation Current Level 1]	x	-
b3-07 [Speed Estimation Current Level 2]	x	-
b3-08 [Speed Estimation ACR P Gain]	x	-
b3-09 [Speed Estimation ACR I Time]	x	-
b3-10 [Speed Estimation Detection Gain]	x	-
b3-14 [Bi-directional Speed Search]	x	o
b3-17 [Speed Est Retry Current Level]	x	x
b3-18 [Speed Est Retry Detection Time]	x	x
b3-19 [Speed Search Restart Attempts]	x	x
b3-24 [Speed Search Method Selection]	x (1)	x (2)
b3-25 [Speed Search Wait Time]	x	x
b3-26 [Direction Determination Level]	x	-
b3-27 [Speed Search RUN/BB Priority]	x	x
b3-29 [Speed Search Back-EMF Threshold]	-	-
b3-31 [Spd Search Current Reference Lvl]	-	x
b3-32 [Spd Search Current Complete Lvl]	-	x
b3-33 [Speed Search during Uv Selection]	x	x
b3-35 [Low Back EMF Detection Level]	x	x
b3-36 [High Back EMF Detection Level]	x	x
b3-54 [Search Time]	-	-
b3-55 [Current Increment Time]	-	-
b3-56 [InverseRotationSearch WaitTime]	-	x

Note:

- To use Speed Estimation Speed Search with V/f Control, do Rotational Auto-Tuning before you set the Speed Search function. If the wire length between the drive and motor changed since the last time you did Auto-Tuning, do Stationary Auto-Tuning for Line-to-Line Resistance process again.
- If $A1-02 = 5, 6$ [*PM Open Loop Vector, PM Advanced Open Loop Vector*] and the wiring distance between the motor and drive is long or if the motor is coasting at more than or equal to 200 Hz, do not use Speed Search to restart the motor. Use Short Circuit Braking.

■ Current Detection 2

Use this Speed Search function with induction motors. Set $b3-24 = 2$ [*Speed Search Method Selection = Current Detection 2*]. Current Detection Speed Search injects current into the motor to detect the speed of an induction motor. Speed Search increases the output voltage for the time set in $L2-04$ [*Powerloss V/f Recovery Ramp Time*], starting from the maximum output frequency or the frequency reference.

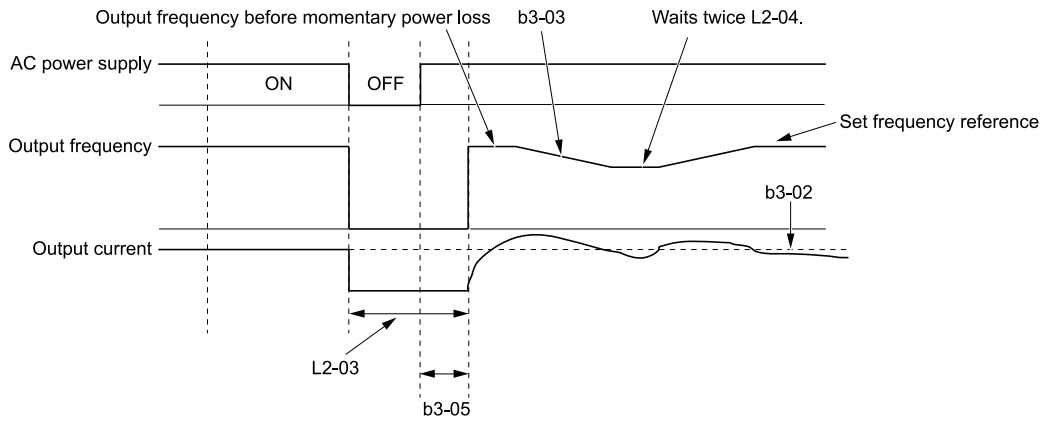

Figure 12.28 Current Detection 2 after a Momentary Power Loss

Note:

Once power is restored, the drive will not execute Speed Search until the time set in *b3-05* [Speed Search Delay Time] has passed. Thus, the drive will not always start Speed Search although the time set in *L2-03* [Minimum Baseblock Time] is expired.

If you enter the Run command at the same time as Speed Search, the drive will not do Speed Search until the time set in *L2-03* is expired. When the value set in *L2-03* < *b3-05*, the drive will use the wait time set in *b3-05*.

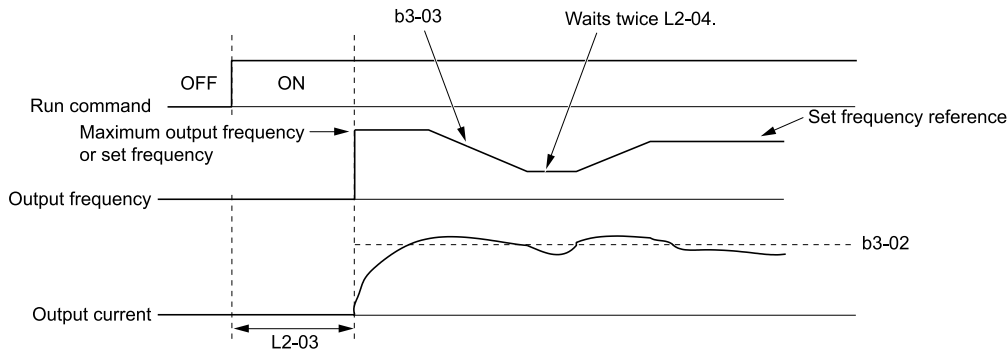

Figure 12.29 Speed Search Selection at Start (Current Detection Type)

WARNING! Sudden Movement Hazard. Do not do Current Detection Speed Search with light loads or a stopped motor. If you do Auto-Tuning in these conditions, the motor can suddenly accelerate and cause serious injury or death.

Note:

- You cannot use Current Detection Speed Search with PM motors.
- If the motor is rotating in reverse, you cannot do Speed Search.
- If the drive detects *oL1* [Motor Overload] during Current Detection Speed Search, decrease the value set in *b3-03*.
- If the drive detects *oC* [Overcurrent] or *ov* [Overvoltage] during Current Detection Speed Search after the drive recovers from a momentary power loss, increase the value set in *L2-03*.

■ Speed Estimation

Use this Speed Search function with induction motors. Set *b3-24* = 1 [Speed Search Method Selection = Speed Estimation]. This function uses less current and has a shorter search time than other functions. This function lets you do Speed Search when the motor is rotating in reverse. When you return power after a power loss, the motor will not suddenly accelerate.

Note:

You cannot do Speed Estimation Speed Search in these conditions:

- When you operate more than one motor with one drive
- When you use a high-speed motor (200 Hz or higher)
- When you use a 1.5 kW or smaller motor.
- When the motor output is more than 1 frame size smaller than the drive capacity
- When there is a long wiring distance between the drive and motor

For these conditions, use Current Detection Speed Search.

Speed Estimation Speed Search uses these two steps to estimate the motor speed:

1. Residual Voltage Search

When there is a short baseblock time, the drive searches for residual voltage. The drive uses the residual voltage in the motor to estimate the motor speed and direction of rotation. The drive outputs the estimated motor speed as frequency, then uses the deceleration rate set in *L2-04* to increase the voltage. When the output voltage aligns with the V/f pattern, the drive accelerates or decelerates the motor to the frequency reference. If the drive cannot estimate the motor speed because of low residual voltage, it will automatically do Current Injection.

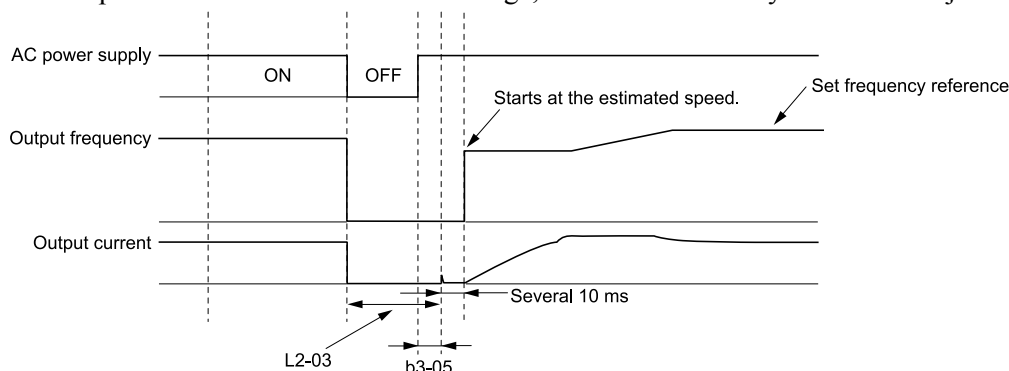

Figure 12.30 Speed Search after Baseblock

Note:

After you return power, the drive waits for the time set in *b3-05*. When power loss is longer than the time set in *L2-03*, the drive will start Speed Search when the time set in *b3-05* is expired after the power recovery.

2. Current Injection

If there is not sufficient residual voltage in the motor, the drive does Current Injection. The drive injects the quantity of DC current set in *b3-06* [*Speed Estimation Current Level 1*] into the motor windings to estimate the motor speed and direction of rotation. The drive outputs the estimated motor speed as frequency, then uses the deceleration rate set in *L2-04* to increase the voltage. When the output voltage aligns with the V/f pattern, the drive accelerates or decelerates the motor to the frequency reference.

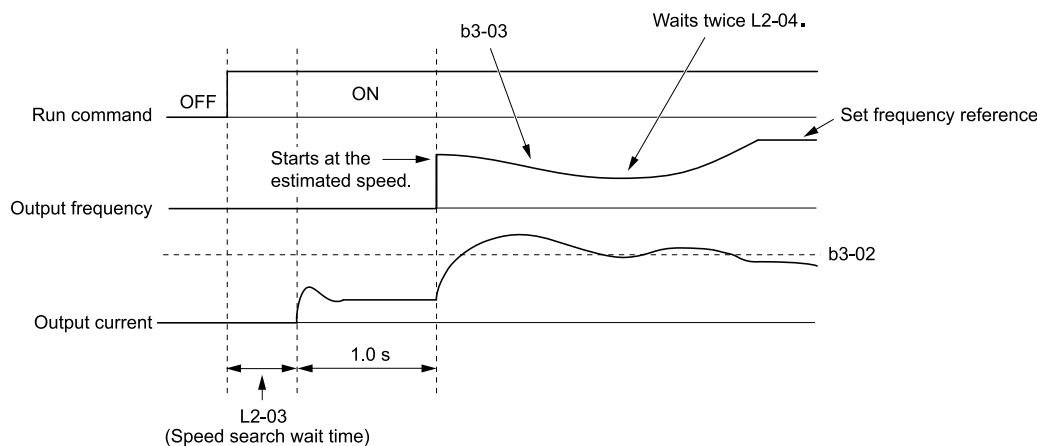

Figure 12.31 Speed Search Selection at Start

Note:

Set the lower limit of the delay time to *b3-05* for when Speed Search starts.

Speed Search and Operation Conditions

These conditions apply to Speed Search operation. When *A1-02 = 0, 1, 2* [*Control Method Selection = V/f Control, V/f Control with Encoder, Open Loop Vector*], set *b3-24* [*Speed Search Method Selection*] before you do Speed Search.

- Do Speed Search with each Run Command
The drive ignores a Speed Search command from the external terminals.
- Use an MFDI to do an External Speed Search Command
To use an MFDI to do Speed Search, input the Run command at the same time that terminal *Sx* set for Speed Search activates, or after Speed Search activates.

Set Speed Search to *H1-xx* to do the function externally. You cannot set external Speed Search 1 and 2 at the same time.

Table 12.23 Execute Speed Search via the Digital Input Terminals

H1-xx Setting	Name	Current Detection 2	Speed Estimation
61	Speed Search from Fmax	ON: Speed Search starts from <i>E1-04 [Maximum Output Frequency]</i> .	External Speed Search commands 1 and 2 work the same. The drive estimates the motor speed, then starts Speed Search from the estimated speed.
62	Speed Search from Fref	ON: Speed Search starts from the frequency reference immediately before you input the Speed Search command.	

- **Do Speed Search with Each Auto Restart**
Set *L5-01 [Number of Auto-Restart Attempts]* = 1 or more. After there is an Auto Restart fault, the drive automatically does Speed Search.
- **Do Speed Search after Momentary Power Loss**
Set *L2-01 = 1, 2 [Power Loss Ride Through Select = Enabled for L2-02 Time, Enabled while CPU Power Active]*.
- **Do Speed Search after You Clear the External Baseblock Command**
After you clear the external baseblock command, enable the Run command, and when the output frequency is higher than the minimum frequency, the drive does Speed Search.

■ **b3-01: Speed Search at Start Selection**

No. (Hex.)	Name	Description	Default (Range)
b3-01 (0191)	Speed Search at Start Selection	<div style="display: flex; justify-content: space-between; align-items: center;"> <input type="checkbox"/> V/f <input type="checkbox"/> CL-V/f <input type="checkbox"/> OLV <input type="checkbox"/> CLV <input type="checkbox"/> AOLV <input type="checkbox"/> OLV/PM <input type="checkbox"/> AOLV/PM <input type="checkbox"/> CLV/PM <input type="checkbox"/> EZOLV </div> Sets the Speed Search at Start function where the drive will perform Speed Search with each Run command.	Determined by A1-02 (0, 1)

0 : Disabled

Enter a Run command to start to operate the drive at the minimum output frequency.

When the Run command is enabled and the *Speed Search from Fmax or Fref [H1-xx = 61, 62]* is input from a multi-function input terminal, the drive will do Speed Search and start to operate the motor.

1 : Enabled

Enter the Run command to do Speed Search. The drive completes Speed Search then starts to operate the motor.

■ **b3-02: SpeedSearch Deactivation Current**

No. (Hex.)	Name	Description	Default (Range)
b3-02 (0192)	SpeedSearch Deactivation Current	<div style="display: flex; justify-content: space-between; align-items: center;"> <input type="checkbox"/> V/f <input type="checkbox"/> CL-V/f <input type="checkbox"/> OLV <input type="checkbox"/> CLV <input type="checkbox"/> AOLV <input type="checkbox"/> OLV/PM <input type="checkbox"/> AOLV/PM <input type="checkbox"/> CLV/PM <input type="checkbox"/> EZOLV </div> Sets the current level that stops Speed Search as a percentage of the drive rated output current. Usually it is not necessary to change this setting.	Determined by A1-02 (0 - 200%)

If the drive cannot restart the motor, decrease this setting.

■ **b3-03: Speed Search Deceleration Time**

No. (Hex.)	Name	Description	Default (Range)
b3-03 (0193)	Speed Search Deceleration Time	<div style="display: flex; justify-content: space-between; align-items: center;"> <input type="checkbox"/> V/f <input type="checkbox"/> CL-V/f <input type="checkbox"/> OLV <input type="checkbox"/> CLV <input type="checkbox"/> AOLV <input type="checkbox"/> OLV/PM <input type="checkbox"/> AOLV/PM <input type="checkbox"/> CLV/PM <input type="checkbox"/> EZOLV </div> Sets the deceleration time during Speed Search operation. Set the length of time to decelerate from the maximum output frequency to the minimum output frequency.	2.0 s (0.1 - 10.0 s)

This is the output frequency deceleration time used by Current Detection Speed Search and by the Current Injection Method of Speed Estimation Speed Search.

Note:

- When *A1-02 = 8 [Control Method Selection = EZOLV]*, this parameter takes effect only in Expert Mode.
- If the drive detects *oL1 [Motor Overload]* during Current Detection Speed Search, decrease the value set in *b3-03*.

■ b3-04: V/f Gain during Speed Search

No. (Hex.)	Name	Description	Default (Range)
b3-04 (0194)	V/f Gain during Speed Search	<div style="display: flex; justify-content: space-between; font-size: 0.8em; font-weight: bold; margin-bottom: 5px;"> V/f CL-V/f OLV CLV AOLV OLV/PM AOLV/PM CLV/PM EZOLV </div> Sets the ratio used to reduce the V/f during searches to reduce the output current during speed searches.	Determined by o2-04 (10 - 100)

Use the this formula to calculate the output voltage during Speed Search:

Output voltage during Speed Search = Configured V/f × b3-04

When the current detection search operates correctly, this configuration is not necessary.

■ b3-05: Speed Search Delay Time

No. (Hex.)	Name	Description	Default (Range)
b3-05 (0195)	Speed Search Delay Time	<div style="display: flex; justify-content: space-between; font-size: 0.8em; font-weight: bold; margin-bottom: 5px;"> V/f CL-V/f OLV CLV AOLV OLV/PM AOLV/PM CLV/PM EZOLV </div> Sets the Speed Search delay time to activate a magnetic contactor installed between the drive and motor.	0.2 s (0.0 - 100.0 s)

When you use a magnetic contactor between the drive and motor, you must close the contactor before the drive will do Speed Search. This parameter sets a delay time to activate the magnetic contactor.

■ b3-06: Speed Estimation Current Level 1

No. (Hex.)	Name	Description	Default (Range)
b3-06 (0196) Expert	Speed Estimation Current Level 1	<div style="display: flex; justify-content: space-between; font-size: 0.8em; font-weight: bold; margin-bottom: 5px;"> V/f CL-V/f OLV CLV AOLV OLV/PM AOLV/PM CLV/PM EZOLV </div> Sets the level of current that flows to the motor during Speed Estimation Speed Search as a coefficient of the motor rated current. Usually it is not necessary to change this setting.	Determined by o2-04 (0.0 - 2.0)

When the speed estimation value is the minimum output frequency, increase this setting. You can do this when the motor coasts at a high speed while the drive estimates the speed during Speed Estimation Speed Search. The limit of the output current during speed search is automatically the drive rated current.

Note:

When the drive cannot accurately estimate the speed after you adjust this parameter, use Current Detection Speed Search.

■ b3-07: Speed Estimation Current Level 2

No. (Hex.)	Name	Description	Default (Range)
b3-07 (0197) Expert	Speed Estimation Current Level 2	<div style="display: flex; justify-content: space-between; font-size: 0.8em; font-weight: bold; margin-bottom: 5px;"> V/f CL-V/f OLV CLV AOLV OLV/PM AOLV/PM CLV/PM EZOLV </div> Sets the level of current that flows to the motor during Speed Estimation Speed Search as a coefficient of E2-03 [Motor No-Load Current] or E4-03 [Motor 2 Rated No-Load Current]. Usually it is not necessary to change this setting.	1.0 (0.0 - 3.0)

During Speed Estimation Speed Searches, when the speed estimation value aligns with the minimum output frequency, increase the setting value in 0.1-unit increments. The limit of the output current during speed search is automatically the drive rated current.

■ b3-08: Speed Estimation ACR P Gain

No. (Hex.)	Name	Description	Default (Range)
b3-08 (0198)	Speed Estimation ACR P Gain	<div style="display: flex; justify-content: space-between; font-size: 0.8em; font-weight: bold; margin-bottom: 5px;"> V/f CL-V/f OLV CLV AOLV OLV/PM AOLV/PM CLV/PM EZOLV </div> Sets the proportional gain for the automatic current regulator during Speed Estimation Speed Search. Also adjusts speed search responsiveness. Usually it is not necessary to change this setting.	Determined by A1-02 and o2-04 (0.00 - 6.00)

■ b3-09: Speed Estimation ACR I Time

No. (Hex.)	Name	Description	Default (Range)
b3-09 (0199)	Speed Estimation ACR I Time	<div style="display: flex; justify-content: space-between; font-size: 0.8em; font-weight: bold;"> V/f CL-V/f OLV CLV AOLV OLV/PM AOLV/PM CLV/PM EZOLV </div> <p>Sets the integral time for the automatic current regulator during Speed Estimation Speed Search. Also adjusts speed search responsiveness. Usually it is not necessary to change this setting.</p>	Determined by A1-02 when A1-02 ≠ 5 20.0 when A1-02 = 5 (0.0 - 1000.0 ms)

■ b3-10: Speed Estimation Detection Gain

No. (Hex.)	Name	Description	Default (Range)
b3-10 (019A) Expert	Speed Estimation Detection Gain	<div style="display: flex; justify-content: space-between; font-size: 0.8em; font-weight: bold;"> V/f CL-V/f OLV CLV AOLV OLV/PM AOLV/PM CLV/PM EZOLV </div> <p>Sets the gain to correct estimated frequencies from Speed Estimation Speed Search.</p>	1.05 (1.00 - 1.20)

If the drive detects *ov* [DC Bus Overvoltage] when you restart the motor, increase the setting value.

■ b3-14: Bi-directional Speed Search

No. (Hex.)	Name	Description	Default (Range)
b3-14 (019E)	Bi-directional Speed Search	<div style="display: flex; justify-content: space-between; font-size: 0.8em; font-weight: bold;"> V/f CL-V/f OLV CLV AOLV OLV/PM AOLV/PM CLV/PM EZOLV </div> <p>Sets the direction of Speed Search to the direction of the frequency reference or in the motor rotation direction as detected by the drive.</p>	Determined by A1-02 and b3-24 (0, 1)

Note:

- Refer to [Parameters that Change from the Default Settings with A1-02 \[Control Method Selection\] on page 590](#) for information about the initial value of *b3-14* [Bi-directional Speed Search] that applies when you set these parameters:
 - A1-02 = 0, 2, 8 [Control Method Selection = V/f, OLV, EZOLV]
 - E9-01 = 0 [Motor Type Selection = Induction (IM)]
 - b3-24 = 1 [Speed Search Method Selection = Speed Estimation Speed Search]
- The initial value of *b3-14* is 0 when you set these parameters:
 - A1-02 = 0, 2, 8
 - E9-01 = 0
 - b3-24 = 2 [Current Detection 2]
- Refer to [Parameters that Change from the Default Settings with A1-02 \[Control Method Selection\] on page 590](#) for information about the initial value of *b3-14* that applies when you set these parameters:
 - A1-02 = 1, 4, 8 [CL-V/f, AOLV, EZOLV]
 - E9-01 = 1, 2 [Permanent Magnet (PM), Synchronous Reluctance (SynRM)]
- When you change *A1-02*, *b3-24*, and *E9-01*, also set *b3-14*.

0 : Disabled

The drive uses the frequency reference to detect the direction of motor rotation.

1 : Enabled

The drive detects the direction of motor rotation during Speed Search.

■ b3-17: Speed Est Retry Current Level

No. (Hex.)	Name	Description	Default (Range)
b3-17 (01F0) Expert	Speed Est Retry Current Level	<div style="display: flex; justify-content: space-between; font-size: 0.8em; font-weight: bold;"> V/f CL-V/f OLV CLV AOLV OLV/PM AOLV/PM CLV/PM EZOLV </div> <p>Sets the current level for the search retry function in Speed Estimation Speed Search as a percentage where drive rated current is a setting value of 100%.</p>	150% (0 - 200%)

When a large quantity of current flows during Speed Estimation Speed Search, the drive temporarily stops operation to prevent overvoltage and overcurrent. When the current is at the level set in *b3-17*, the drive tries speed search again.

■ b3-18: Speed Est Retry Detection Time

No. (Hex.)	Name	Description	Default (Range)
b3-18 (01F1) Expert	Speed Est Retry Detection Time	<div style="display: flex; justify-content: space-between; font-size: 0.8em; font-weight: normal;"> V/f CL-V/f OLV CLV AOLV OLV/PM AOLV/PM CLV/PM EZOLV </div> <p>Sets the length of time that the drive will wait to retry Speed Estimation Speed Search when too much current flow stopped the Speed Search.</p>	0.10 s (0.00 - 1.00 s)

When the current is more than the level set in *b3-17 [Speed Est Retry Current Level]* during the time set in *b3-18*, the drive tries speed search again.

■ b3-19: Speed Search Restart Attempts

No. (Hex.)	Name	Description	Default (Range)
b3-19 (01F2)	Speed Search Restart Attempts	<div style="display: flex; justify-content: space-between; font-size: 0.8em; font-weight: normal;"> V/f CL-V/f OLV CLV AOLV OLV/PM AOLV/PM CLV/PM EZOLV </div> <p>Sets the number of times to restart Speed Search if Speed Search does not complete.</p>	3 times (0 - 10 times)

If the drive does the number of Speed Search restarts set in this parameter, it will trigger an *SEr [Speed Search Retries Exceeded]* error.

■ b3-24: Speed Search Method Selection

No. (Hex.)	Name	Description	Default (Range)
b3-24 (01C0)	Speed Search Method Selection	<div style="display: flex; justify-content: space-between; font-size: 0.8em; font-weight: normal;"> V/f CL-V/f OLV CLV AOLV OLV/PM AOLV/PM CLV/PM EZOLV </div> <p>Sets the Speed Search method when you start the motor or when you return power after a momentary power loss.</p>	2 (1, 2)

Note:

- The default setting is different for different control methods.
 - A1-02 = 0, 2 [Control Method Selection = V/f, OLV]: 2
 - A1-02 = 1 [CL-V/f]: 1
 - A1-02 = 8 [EZOLV] and E9-01 = 0 [Motor Type Selection = Induction (IM)]: 2
 - A1-02 = 8 and E9-01 ≠ 0: 1
- Set *b3-24 = 1*. If *b3-24 = 2*, the drive will detect *oPE08 [Parameter Selection Error]*.

Set *b3-01 = 1 [Speed Search at Start Selection = Enabled]* to do Speed Search at start. Set *L2-01 = 1 [Power Loss Ride Through Select = Enabled for L2-02 Time]* to do Speed Search after you restore power after a momentary power loss.

1 : Speed Estimation

The drive uses the residual voltage from a short baseblock time to estimate the motor speed.

If there is not sufficient residual voltage, then the drive will inject DC current into the motor to estimate the motor speed.

2 : Current Detection 2

The drive will inject DC current into the motor to estimate motor speed.

■ b3-25: Speed Search Wait Time

No. (Hex.)	Name	Description	Default (Range)
b3-25 (01C8) Expert	Speed Search Wait Time	<div style="display: flex; justify-content: space-between; font-size: 0.8em; font-weight: normal;"> V/f CL-V/f OLV CLV AOLV OLV/PM AOLV/PM CLV/PM EZOLV </div> <p>Sets the length of time the drive will wait to start the Speed Search Retry function.</p>	0.5 s (0.0 - 30.0 s)

If the drive detects these faults during speed search, increase the setting value:

- oC [Overcurrent]*
- ov [Overvoltage]*
- SEr [Speed Search Retries Exceeded]*

■ b3-26: Direction Determination Level

No. (Hex.)	Name	Description	Default (Range)
b3-26 (01C7) Expert	Direction Determination Level	<div style="display: flex; justify-content: space-between; align-items: center;"> V/f CL-V/f OLV CLV AOLV OLV/PM AOLV/PM CLV/PM EZOLV </div> <p>Sets the level to find the motor rotation direction. Increase the value if the drive cannot find the direction.</p>	1000 (40 to 60000)

■ b3-27: Speed Search RUN/BB Priority

No. (Hex.)	Name	Description	Default (Range)
b3-27 (01C9) Expert	Speed Search RUN/BB Priority	<div style="display: flex; justify-content: space-between; align-items: center;"> V/f CL-V/f OLV CLV AOLV OLV/PM AOLV/PM CLV/PM EZOLV </div> <p>Sets the conditions necessary to start Speed Search.</p>	0 (0, 1)

Executes *Speed Search from Fmax or Fref* [$H1-xx = 61/62$] for initial speed searches or from the MFDI terminal.

0 : SS Only if RUN Applied Before BB

1 : SS Regardless of RUN/BB Sequence

■ b3-29: Speed Search Back-EMF Threshold

No. (Hex.)	Name	Description	Default (Range)
b3-29 (077C) Expert	Speed Search Back-EMF Threshold	<div style="display: flex; justify-content: space-between; align-items: center;"> V/f CL-V/f OLV CLV AOLV OLV/PM AOLV/PM CLV/PM EZOLV </div> <p>Sets the induced voltage for motors that use Speed Search. The drive will start Speed Search when the motor induced voltage level is the same as the setting value. Usually it is not necessary to change this setting.</p>	10% (0 - 10%)

To make adjustments, gradually decrease the setting value. If you decrease the setting value too much, speed search will not operate correctly.

■ b3-31: Spd Search Current Reference Lvl

No. (Hex.)	Name	Description	Default (Range)
b3-31 (0BC0) Expert	Spd Search Current Reference Lvl	<div style="display: flex; justify-content: space-between; align-items: center;"> V/f CL-V/f OLV CLV AOLV OLV/PM AOLV/PM CLV/PM EZOLV </div> <p>Sets the current level that decreases the output current during Current Detection Speed Search.</p>	1.50 (1.50 - 3.50)

Set this parameter as a ratio of $E2-03$ [*Motor No-Load Current*]. The setting is a ratio with respect to 30% of the motor rated current when $E2-03 \leq E2-01$ [*Motor Rated Current*] $\times 0.3$.

Note:

The setting is a ratio with respect to $E9-06$ [*Motor Rated Current (FLA)*] $\times 0.5$ when $A1-02 = 8$ [*Control Method Selection = EZOLV*].

■ b3-32: Spd Search Current Complete Lvl

No. (Hex.)	Name	Description	Default (Range)
b3-32 (0BC1) Expert	Spd Search Current Complete Lvl	<div style="display: flex; justify-content: space-between; align-items: center;"> V/f CL-V/f OLV CLV AOLV OLV/PM AOLV/PM CLV/PM EZOLV </div> <p>Sets the current level that completes Speed Search.</p>	1.20 (0.00 - 1.49)

The Current Detection Speed Search gradually decreases the output frequency to search for the motor speed when the output current is equal to or less than Speed Search Current Complete Level.

Set this parameter as a ratio of $E2-03$ [*Motor No-Load Current*]. The setting is a ratio with respect to 30% of the motor rated current when $E2-03 \leq E2-01$ [*Motor Rated Current*] $\times 0.3$.

Note:

The setting is a ratio with respect to $E9-06$ [*Motor Rated Current (FLA)*] $\times 0.5$ when $A1-02 = 8$ [*Control Method Selection = EZOLV*].

■ b3-33: Speed Search during Uv Selection

No. (Hex.)	Name	Description	Default (Range)
b3-33 (0B3F) Expert	Speed Search during Uv Selection	<div style="display: flex; justify-content: space-between; font-size: 0.8em;"> V/f CL-V/f OLV CLV AOLV OLV/PM AOLV/PM CLV/PM EZOLV </div> <p>Sets the function that starts Speed Search at start-up if the drive detects a <i>Uv</i> [Undervoltage] when it receives a Run command.</p>	1 (0, 1)

Set these three parameters as shown to enable *b3-33*:

- *L2-01* = 1, 2 [Power Loss Ride Through Select = Enabled for L2-02 Time, Enabled while CPU Power Active]
- *b3-01* = 1 [Speed Search at Start Selection = Enabled]
- *b1-03* = 1 [Stopping Method Selection = Coast to Stop]

0 : Disabled

1 : Enabled

■ b3-35: Low Back EMF Detection Level

No. (Hex.)	Name	Description	Default (Range)
b3-35 (0BC3) Expert	Low Back EMF Detection Level	<div style="display: flex; justify-content: space-between; font-size: 0.8em;"> V/f CL-V/f OLV CLV AOLV OLV/PM AOLV/PM CLV/PM EZOLV </div> <p>Sets the Low Back EMF Detection Level. Usually it is not necessary to change this setting.</p>	10% (5 - 50%)

■ b3-36: High Back EMF Detection Level

No. (Hex.)	Name	Description	Default (Range)
b3-36 (0BC4) Expert	High Back EMF Detection Level	<div style="display: flex; justify-content: space-between; font-size: 0.8em;"> V/f CL-V/f OLV CLV AOLV OLV/PM AOLV/PM CLV/PM EZOLV </div> <p>Sets the voltage level for Speed Search restart. Usually it is not necessary to change this setting.</p>	0.970 (0.500 - 1.000)

The drives wait for Speed Search to prevent failure when the induced voltage for the motor during coasting to a stop is larger than the voltage the drive can output. The drive will not restart the motor (Speed Search) if induced voltage \geq supply voltage \times *b3-36* after a Run command is entered. The drive will restart the motor when induced voltage $<$ supply voltage \times *b3-36*. For example, if the setting value is 0.83 and the voltage does not decrease to the induced voltage at approximately 183 V when the power supply voltage is 220 V, the drive will not restart.

■ b3-54: Search Time

No. (Hex.)	Name	Description	Default (Range)
b3-54 (3123)	Search Time	<div style="display: flex; justify-content: space-between; font-size: 0.8em;"> V/f CL-V/f OLV CLV AOLV OLV/PM AOLV/PM CLV/PM EZOLV </div> <p>Sets the length of time that the drive will run Speed Search.</p>	400 ms (10 - 2000 ms)

If you set this parameter too low, Speed Search will not operate correctly.

If the drive detects *oC* [Overcurrent] immediately after Speed Search Starts:

- Increase the value of *L2-03* [Minimum Baseblock Time] and decrease the motor speed you use to start Speed Search.
- Increases the setting value of *b3-08* [Speed Estimation ACR P Gain].
- Increase the value of *b3-54*.

If the drive detects *oC* or *ov* [DC Bus Overvoltage] during Speed Search, increase the value of *b3-08*.

■ b3-55: Current Increment Time

No. (Hex.)	Name	Description	Default (Range)
b3-55 (3124) Expert	Current Increment Time	<div style="display: flex; justify-content: space-between; font-size: 0.8em;"> V/f CL-V/f OLV CLV AOLV OLV/PM AOLV/PM CLV/PM EZOLV </div> <p>Sets the length of time that the drive will increase the current from zero current to the setting value of <i>b3-06</i> [Speed Estimation Current Level 1].</p>	10 ms (10 - 2000 ms)

Gradually increase the setting value when a large quantity of current flows after speed search starts. If you set this value too high, speed search will not operate correctly.

■ **b3-56: InverseRotationSearch WaitTime**

No. (Hex.)	Name	Description	Default (Range)
b3-56 (3126)	InverseRotationSearch WaitTime	<div style="display: flex; justify-content: space-between; font-size: small;"> V/f CL-V/f OLV CLV AOLV OLV/PM AOLV/PM CLV/PM EZOLV </div> <p>Sets the wait time until the drive starts inverse rotation search after it completes forward search when you do inverse rotation search during Current Detection Speed Search.</p>	Determined by o2-04 (0.1 - 5.0 s)

■ **b3-61: Init Magnet Pole Estimation Gain**

No. (Hex.)	Name	Description	Default (Range)
b3-61 (1B96) Expert	Init Magnet Pole Estimation Gain	<div style="display: flex; justify-content: space-between; font-size: small;"> V/f CL-V/f OLV CLV AOLV OLV/PM AOLV/PM CLV/PM EZOLV </div> <p>Adjusts the Initial Pole Detection response gain when $A1-02 = 6$ [Control Method Selection = AOLV/PM]. Set $b3-61 > 0.0$ for a general IPM motor.</p>	5.0 (-20.0 - +20.0)

Use this when $n8-35 = 1$ [Initial Pole Detection Method = High Frequency Injection]. Adjusts the response gain for Initial Pole Detection. Specify a positive value for an ordinary motor. The drive sets this value automatically when High Frequency Injection Tuning completes correctly.

◆ **b4: Timer Function**

The drive uses timers to delay activating and deactivating MFDO terminals.

Timers prevent sensors and switches from making chattering noise.

There are two types of timers:

- Timers that set a delay for timer inputs and timer outputs. These timers delay activating and deactivating of the MFDI and MFDOs. To enable this function, set $H1-xx = 18$ [MFDI Function Select = Timer Function], and set $H2-01$ to $H2-03 = 12$ [MFDO Function Select = Timer Output].
- Timers that set a delay to activate and deactivate MFDO terminals. These timers delay activating and deactivating MFDO terminals. To enable this function, set delay times in parameters $b4-03$ to $b4-08$.

■ **Timer Function Operation**

- Timers that Set a Delay for Timer Inputs and Timer Outputs
Triggers timer output if the timer input is active for longer than the time set in $b4-01$ [Timer Function ON-Delay Time]. Triggers timer output late for the time set in $b4-02$ [Timer Function OFF-Delay Time]. Figure 12.32 shows an example of how the timer function works.

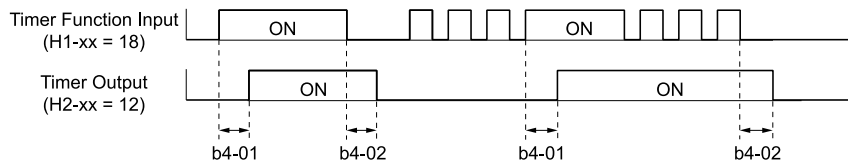

Figure 12.32 Example of Timer Function Operation

- Setting On/Off-delay Time for MFDO
Figure 12.33 uses H2-01 terminals to show an example of how the timer function works. Use $b4-03$ [Terminal M1-M2 ON-Delay Time] and $b4-04$ [Terminal M1-M2 OFF-Delay Time] to set this function.

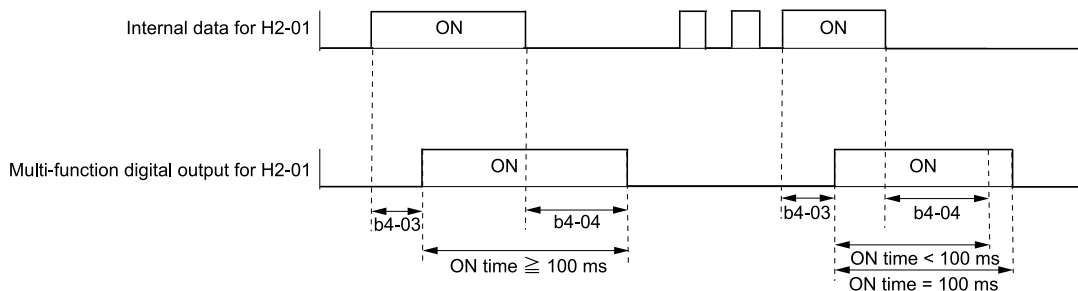

Figure 12.33 Example of How the Timer Function Works with H2-01 Terminals

Note:

When the terminal is triggered, it continues for a minimum of 100 ms. The on/off-delay time of MFDO terminal does not have an effect.

■ b4-01: Timer Function ON-Delay Time

No. (Hex.)	Name	Description	Default (Range)
b4-01 (01A3)	Timer Function ON-Delay Time	V/f CL-V/f OLV CLV AOLV OLV/PM AOLV/PM CLV/PM EZOLV Sets the ON-delay time for the timer input.	0.0 s (0.0 - 3000.0 s)

■ b4-02: Timer Function OFF-Delay Time

No. (Hex.)	Name	Description	Default (Range)
b4-02 (01A4)	Timer Function OFF-Delay Time	V/f CL-V/f OLV CLV AOLV OLV/PM AOLV/PM CLV/PM EZOLV Sets the OFF-delay time for the timer input.	0.0 s (0.0 - 3000.0 s)

■ b4-03: Terminal M1-M2 ON-Delay Time

No. (Hex.)	Name	Description	Default (Range)
b4-03 (0B30) Expert	Terminal M1-M2 ON-Delay Time	V/f CL-V/f OLV CLV AOLV OLV/PM AOLV/PM CLV/PM EZOLV Sets the delay time until the contact is turned ON after the function set with <i>H2-01</i> turns ON.	0 ms (0 - 65000 ms)

■ b4-04: Terminal M1-M2 OFF-Delay Time

No. (Hex.)	Name	Description	Default (Range)
b4-04 (0B31) Expert	Terminal M1-M2 OFF-Delay Time	V/f CL-V/f OLV CLV AOLV OLV/PM AOLV/PM CLV/PM EZOLV Sets the delay time to deactivate the contact after the function set in <i>H2-01</i> deactivates.	0 ms (0 - 65000 ms)

■ b4-05: Terminal M3-M4 ON-Delay Time

No. (Hex.)	Name	Description	Default (Range)
b4-05 (0B32) Expert	Terminal M3-M4 ON-Delay Time	V/f CL-V/f OLV CLV AOLV OLV/PM AOLV/PM CLV/PM EZOLV Sets the delay time to activate the contact after the function set in <i>H2-02</i> activates.	0 ms (0 - 65000 ms)

■ b4-06: Terminal M3-M4 OFF-Delay Time

No. (Hex.)	Name	Description	Default (Range)
b4-06 (0B33) Expert	Terminal M3-M4 OFF-Delay Time	V/f CL-V/f OLV CLV AOLV OLV/PM AOLV/PM CLV/PM EZOLV Sets the delay time to deactivate the contact after the function set in <i>H2-02</i> deactivates.	0 ms (0 - 65000 ms)

■ **b4-07: Terminal M5-M6 ON-Delay Time**

No. (Hex.)	Name	Description	Default (Range)
b4-07 (0B34) Expert	Terminal M5-M6 ON-Delay Time	V/f CL-V/f OLV CLV AOLV OLV/PM AOLV/PM CLV/PM EZOLV Sets the delay time to activate the contact after the function set in <i>H2-03</i> activates.	0 ms (0 - 65000 ms)

■ **b4-08: Terminal M5-M6 OFF-Delay Time**

No. (Hex.)	Name	Description	Default (Range)
b4-08 (0B35) Expert	Terminal M5-M6 OFF-Delay Time	V/f CL-V/f OLV CLV AOLV OLV/PM AOLV/PM CLV/PM EZOLV Sets the delay time to deactivate the contact after the function set in <i>H2-03</i> deactivates.	0 ms (0 - 65000 ms)

◆ **b5: PID Control**

The drive has a PID control function. You can control drive output to adjust the proportional gain, integral time, and derivative time that has an effect on the bias between the target value and the feedback value to align the target value with the detected value. Use this function to adjust the drive output to accurately match the flow, pressure, and temperature in the application match the target value.

Use a combination of these controls to increase the performance:

- **P control**
P control has a proportional effect on the deviation. It outputs the product (the controlled output) proportional to the deviation. You cannot use only the offset from P control to get to zero deviation.
- **I control**
I control is the integral of the deviation. It uses an integral value of the deviation to output the product (the controlled output). I control helps align the feedback value and the target value. If you use the proportional effect (P Control) only, it will cause offset. If you use the proportional effect with the integral operation, it will gradually remove the offset over time.
- **D control**
D control is the derivative of the deviation. If there are sudden, large changes in the deviation or feedback value, it will have an effect on drive output. It quickly returns drive output to the value before the sudden change. It multiplies a time constant by a derivative value of the deviation (slope of the deviation), and adds that result to PID input to calculate the deviation of the signal, then it corrects the deviation.

Note:

D control has causes less stable operation because the noise changes the deviation signal. Use D control only when necessary.

■ **PID Control Operation**

Figure 12.34 shows PID control operation. The modified output (output frequency) changes when the drive uses PID control to keep the deviation (the difference between the target value and the feedback value) constant.

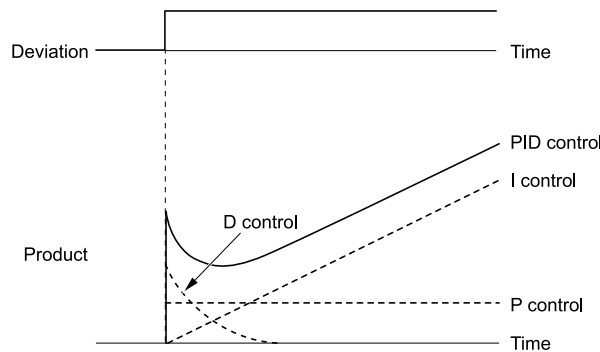

Figure 12.34 PID Control Operation

■ PID Control Applications

Table 12.24 shows applications for PID control.

Table 12.24 PID Control Applications

Application	Control Content	Sensors Used
Speed Control	<ul style="list-style-type: none"> The drive uses a feedback signal for the machine speed, and adjusts that speed to align with the target value. The drive uses speed data from other machinery as the target value to do synchronous control. The drive then adds that target value to the feedback from the machine it is operating to align its speed with the other machinery. 	Tacho generator
Pressure control	The drive uses feedback from the actual pressure to hold constant pressure.	Pressure sensor
Flow control	The drive uses feedback from the actual flow to hold constant flow.	Flow rate sensor
Temperature control	The drive uses feedback from the actual temperature to control a fan and hold constant temperature.	Thermocoupler, thermistor

■ Input Methods for the PID Setpoint

Use *b5-01 [PID Mode Setting]* to select how the PID setpoint is input to the drive.

When *b5-01 = 1 or 2 [Standard or Standard (D on feedback)]*, the frequency reference set in *b1-01 [Frequency Reference Selection 1]* or *b1-15 [Frequency Reference Selection 2]* will be the PID setpoint, or the one of the values shown in Table 12.25 will be the PID setpoint.

When *b5-01 = 3 or 4 [Fref + PID Trim or Fref + PID Trim (D on feedback)]*, one of the inputs in Table 12.25 will be the PID setpoint.

Table 12.25 Input Methods for the PID Setpoint

Input Methods for the PID Setpoint	Setting Value
Multi-function analog input terminal A1	Set <i>H3-02 = C [Terminal A1 Function Selection = PID Setpoint]</i> .
Multi-function analog input terminal A2	Set <i>H3-10 [Terminal A2 Function Selection] = C</i> .
Multi-function analog input terminal A3	Set <i>H3-06 [Terminal A3 Function Selection] = C</i> .
MEMOBUS/Modbus register 0006H	Sets MEMOBUS/Modbus register 000FH (Control Selection Setting) bit 1 to 1 (PID setpoint input). Enters the PID setpoint to MEMOBUS/Modbus register 0006H (PID Target, 0.01% units, signed).
Pulse train input terminal RP	Set <i>H6-01 = 2 [Terminal RP Pulse Train Function = PID Setpoint Value]</i> .
<i>b5-19 [PID Setpoint Value]</i>	Set <i>b5-18 = 1 [b5-19 PID Setpoint Selection = Enabled]</i> . Enters the PID setpoint to <i>b5-19</i> .

Note:

If you set two inputs for the PID setpoint, it will trigger operation error *oPE07 [Analog Input Selection Error]*.

■ Entering the PID Feedback Value

You can use two methods to input the PID feedback value to the drive. One method uses a single feedback signal for usual PID control. The other method uses two signals. The difference between those signals sets the deviation.

• Use one feedback signal.

Use Table 12.26 to select how the feedback signal is input to the drive for PID control.

Table 12.26 PID Feedback Input Method

PID Feedback Input Method	Setting Value
Multi-function analog input terminal A1	Set <i>H3-02 = B [PID Feedback]</i> .
Multi-function analog input terminal A2	Set <i>H3-10 = B</i> .
Multi-function analog input terminal A3	Set <i>H3-06 = B</i> .
Pulse train input terminal RP	Set <i>H6-01 = 1 [PID feedback value]</i> .

• The drive uses two feedback signals, and the difference between those signals becomes the deviation.

Use to select how the second feedback signal is input to the drive.

Use Table 12.27 to select how the second feedback value is input to the drive. The drive calculates the deviation of the second feedback value. Set H3-02, H3-06, or H3-10 = 16 [Terminal A1/A3/A2 Function Selection = Differential PID Feedback] to enable the second feedback signal used to calculate the deviation.

Table 12.27 PID Differential Feedback Input Method

PID Differential Feedback Input Method	Setting Value
Multi-function analog input terminal A1	Set H3-02 = 16 [Differential PID Feedback].
Multi-function analog input terminal A2	Set H3-10 = 16.
Multi-function analog input terminal A3	Set H3-06 = 16.

Note:

If you set more than one of H3-02, H3-06, and H3-10 to 16, the drive will detect oPE07 [Analog Input Selection Error].

■ PID Control Block Diagram

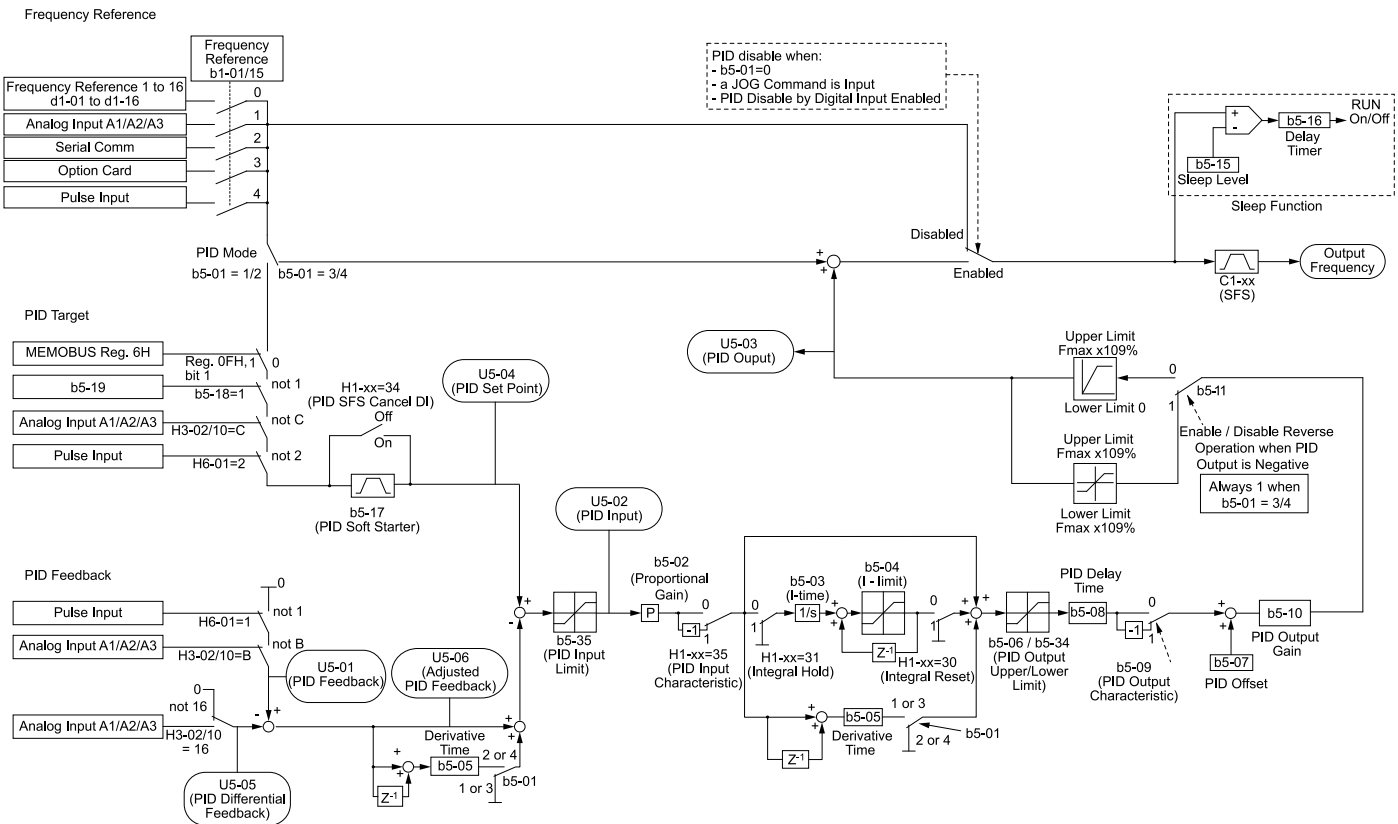

Figure 12.35 PID Block Diagram

■ PID Feedback Loss Detection

The PID feedback loss detection function detects broken sensors and defective wiring between the drive and sensors. Use the PID feedback loss detection function when you use PID control. If the feedback signal is too low, the motor can suddenly accelerate to the maximum output frequency. This function prevents such risks to the load.

The drive uses two methods to detect feedback loss:

• *PID Feedback Loss [FbL]*

Set these parameters for the PID feedback loss detection function.

The drive detects feedback loss when the feedback value is less than the value in b5-13 for longer than the time in b5-14.

- b5-12 [Feedback Loss Detection Select]
- b5-13 [PID Feedback Loss Detection Lvl]
- b5-14 [PID Feedback Loss Detection Time]

- *Excessive PID Feedback [FbH]*

Set these parameters to set how the drive detects a feedback level that is too high.

The drive detects too much PID feedback when the feedback value is more than the value in *b5-36* for longer than the time in *b5-37*.

- *b5-12 [Feedback Loss Detection Select]*

- *b5-36 [PID High Feedback Detection Lvl]*

- *b5-37 [PID High Feedback Detection Time]*

Figure 12.36 shows the operation principle when the feedback value is too low, and the drive detects feedback loss. The operation is the same when the drive detects too much feedback.

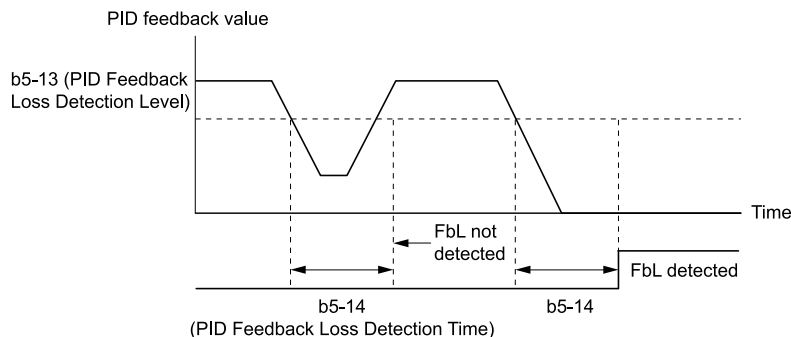

Figure 12.36 Time Chart for PID Feedback Loss Detection Time

■ PID Sleep

PID sleep stops drive operation when the PID output or the frequency reference is less than *b5-15 [PID Sleep Function Start Level]*. This function shuts off drive output after the motor decelerates to the set frequency.

The drive will automatically restart the motor when the PID output or the frequency reference is more than the *b5-15* value for the time set in *b5-16 [PID Sleep Delay Time]*.

Figure 12.37 shows the PID Sleep function.

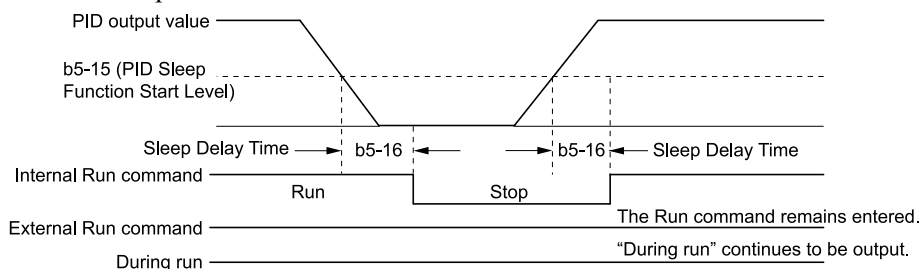

Figure 12.37 PID Sleep Time Chart

Note:

- The PID Sleep function is enabled when PID control is disabled.
- When the PID Sleep function is triggered, the drive will stop the motor as specified by *b1-03 [Stopping Method Selection]*.

■ Fine-Tuning PID

Fine-tune the following parameter settings to have PID control eliminate problems with overshoot and oscillation.

- *b5-02 [Proportional Gain (P)]*
- *b5-03 [Integral Time (I)]*
- *b5-05 [Derivative Time (D)]*
- *b5-08 [PID Primary Delay Time Constant]*

12.3 b: Application

Purpose	Procedure	Results
Prevent overshoot.	<ul style="list-style-type: none"> Set <i>b5-05</i> [Derivative Time (D)] to a smaller value. Set <i>b5-03</i> [Integral Time (I)] to a larger value. 	
Quickly stabilize control.	<ul style="list-style-type: none"> Set <i>b5-05</i> [Derivative Time (D)] to a larger value. Set <i>b5-03</i> [Integral Time (I)] to a smaller value. 	
Prevent long-cycle oscillations.	Set <i>b5-03</i> [Integral Time (I)] to a larger value.	
Prevent short-cycle oscillations.	<ul style="list-style-type: none"> Set <i>b5-05</i> [Derivative Time (D)] to a smaller value. If you set <i>b5-05</i> = 0.00 [Derivative Time (D) = disabling D control] and it does not stop oscillation, then set <i>b5-02</i> [Proportional Gain (P)] to a smaller value or set <i>b5-08</i> [PID Primary Delay Time Constant] to a larger value. 	

■ EZ Sleep/Wake-up Functionality

Set *b5-89* = 1 [Sleep Method Selection = EZ Sleep/Wake-up] to enable the EZ Sleep/Wake-up function.

Note:

- When *b5-89* = 0 [Sleep Mode Selection = Standard], the EZ Sleep function and related parameters are disabled. Parameter *b5-91* [EZ Minimum Speed] is not included in this rule.
- Set *b5-89* = 1 to disable *b5-15* [PID Sleep Function Start Level].

Configuration Parameter	Description
<i>b5-90</i> [EZ Sleep Unit]	Sets the unit of measure for <i>b5-92</i> [EZ Sleep Level]. When <i>b5-90</i> = 0 [0.1Hz units], the setting range of <i>b5-91</i> [EZ Minimum Speed] is 0.0 to 590.0 Hz. When <i>b5-90</i> = 1 [rev/min], the setting range is 0 to 35400 min ⁻¹ (r/min). Note: When you change <i>b5-90</i> , the value of <i>b5-92</i> is not automatically updated.
<i>b5-91</i> [EZ Minimum Speed]	This parameter sets the lower limit for PID output. The drive uses the largest value of <i>b5-91</i> , <i>b5-34</i> [PID Output Lower Limit], and <i>d2-02</i> [Frequency Reference Lower Limit] to internally set the lower limit of PID output. The <i>b5-89</i> setting does not have an effect.
<i>b5-92</i> [EZ Sleep Level]	When the output frequency or motor speed is less than the value of <i>b5-92</i> for longer than the value of <i>b5-93</i> [EZ Sleep Time], the drive does to sleep.
<i>b5-95</i> = 0 [EZ Wake-up Mode = Absolute]	When the PID feedback is less than the value of <i>b5-94</i> [EZ Wake-up Level] for longer than the time set in <i>b5-96</i> [EZ Sleep Wake-up Time], the drive restarts operation from sleep.
<i>b5-95</i> = 1 [EZ Wake-up Mode = Setpoint Delta]	When the PID feedback is less than the value set as the PID setpoint value minus <i>b5-94</i> for the time set in <i>b5-96</i> , the drive restarts operation from sleep.

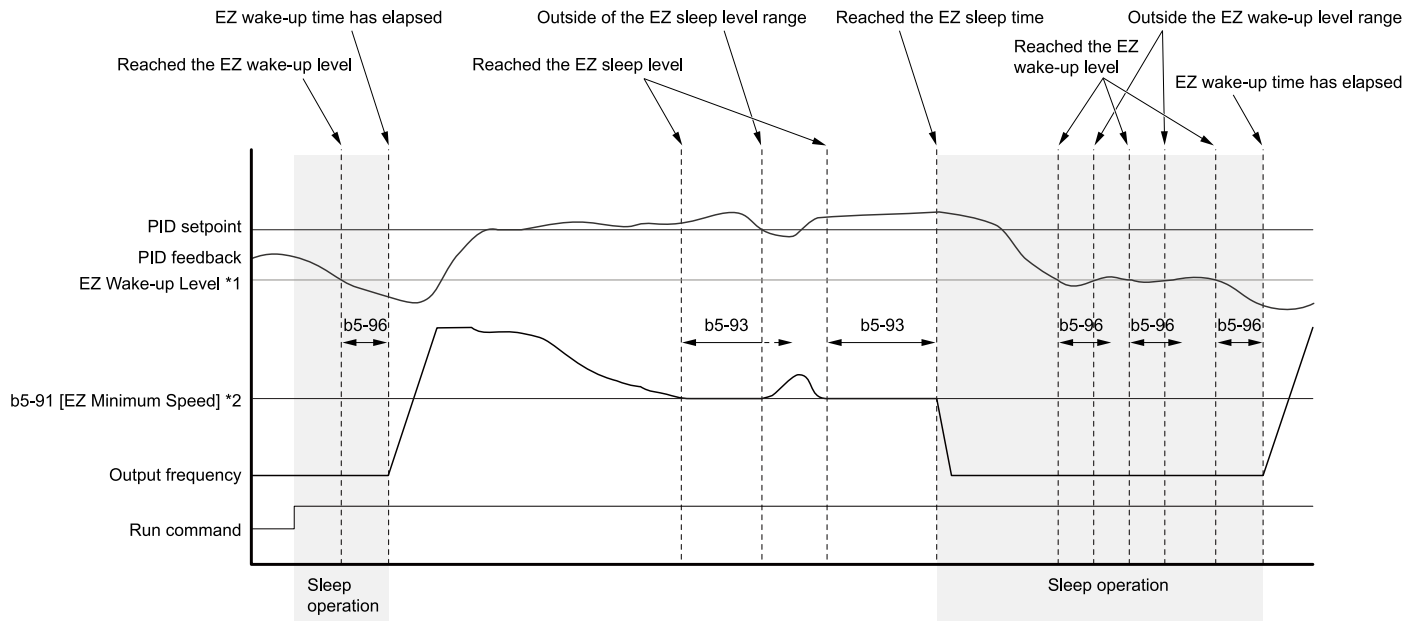

Figure 12.38 EZ Sleep/Wake-up Operation: PID Output is Normal and *b5-92* = 0.0 Hz

*1 The values of *b5-94* and *b5-95* set operation.

*2 In the example, *b5-92* is at the default setting of 0.0 Hz. *b5-91* is the EZ sleep level.

■ b5-01: PID Mode Setting

No. (Hex.)	Name	Description	Default (Range)
<i>b5-01</i> (01A5)	PID Mode Setting	V/f CL-V/f OLV CLV AOLV OLV/PM AOLV/PM CLV/PM EZOLV Sets the type of PID control.	0 (0 - 8)

0 : PID control disabled

1 : Standard

Enables PID control. The drive performs D control on the difference between the feedback value and the PID setpoint output via *U5-02* [PID Input].

2 : Standard (D on feedback)

Enables PID control. The drive performs D control on the feedback output via *U5-06* [PID Fdbk-Diff PID Fdbk].

3 : Fref + PID Trim

Enables PID control. The drive adds the frequency reference to the PID output. The drive performs D control on the difference between the feedback value and the PID setpoint output via *U5-02* [PID Input].

4 : Fref + PID Trim (D on feedback)

12.3 b: Application

Enables PID control. The drive adds the frequency reference to the PID output. The drive performs D control on the feedback output via *U5-06 [PID Fdbk-Diff PID Fdbk]*.

5 : Same as 7series & prior, b5-01=1

6 : Same as 7series & prior, b5-01=2

7 : Same as 7series & prior, b5-01=3

8 : Same as 7series & prior, b5-01=4

Note:

Use settings 5 to 8 when the drive is a replacement for a previous generation drive.

■ b5-02: Proportional Gain (P)

No. (Hex.)	Name	Description	Default (Range)
b5-02 (01A6) RUN	Proportional Gain (P)	V/f CL-V/f OLV CLV AOLV OLV/PM AOLV/PM CLV/PM EZOLV Sets the proportional gain (P) that is applied to PID input.	1.00 (0.00 - 25.00)

Larger values decrease errors, but can cause oscillations. Smaller values let too much offset between the setpoint and feedback.

Set *b5-02 = 0.00* to disable P control.

■ b5-03: Integral Time (I)

No. (Hex.)	Name	Description	Default (Range)
b5-03 (01A7) RUN	Integral Time (I)	V/f CL-V/f OLV CLV AOLV OLV/PM AOLV/PM CLV/PM EZOLV Sets the integral time (I) that is applied to PID input.	1.0 s (0.0 - 360.0 s)

Set a short integral time in *b5-03* to remove the offset more quickly. If the integral time is too short, overshoot or oscillation can occur.

Set *b5-03 = 0.00* to disable I control.

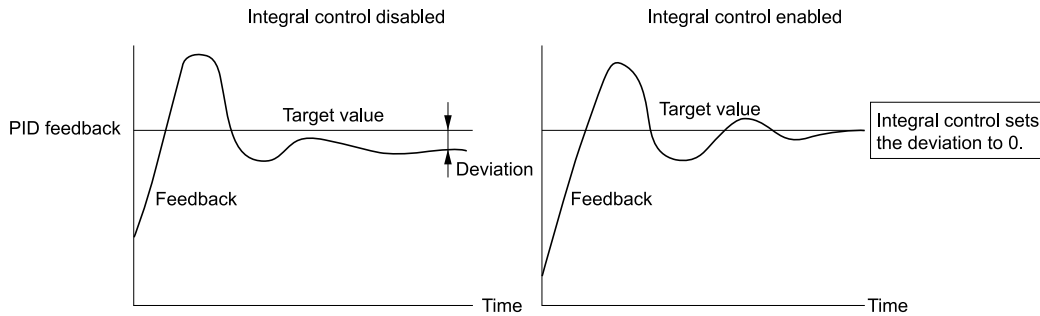

Figure 12.39 Integral Time and Deviation

■ b5-04: Integral Limit

No. (Hex.)	Name	Description	Default (Range)
b5-04 (01A8) RUN	Integral Limit	V/f CL-V/f OLV CLV AOLV OLV/PM AOLV/PM CLV/PM EZOLV Sets the upper limit for integral control (I) as a percentage of the Maximum Output Frequency.	100.0% (0.0 - 100.0%)

Applications with loads that quickly change will cause the output of the PID function to oscillate. Set this parameter to a low value to prevent oscillation, mechanical loss, and motor speed loss.

■ b5-05: Derivative Time (D)

No. (Hex.)	Name	Description	Default (Range)
b5-05 (01A9) RUN	Derivative Time (D)	<div style="display: flex; justify-content: space-between; gap: 5px;"> V/f CL-V/f OLV CLV AOLV OLV/PM AOLV/PM CLV/PM EZOLV </div> Sets the derivative time (D) for PID control. This parameter adjusts system responsiveness.	0.00 s (0.00 - 10.00 s)

When you increase the time setting, it will increase controller responsiveness, but it can also cause vibration. When you decrease the time setting, it will suppress overshoot and decrease controller responsiveness.

Set *b5-05 = 0.00* to disable D control.

■ b5-06: PID Output Limit

No. (Hex.)	Name	Description	Default (Range)
b5-06 (01AA) RUN	PID Output Limit	<div style="display: flex; justify-content: space-between; gap: 5px;"> V/f CL-V/f OLV CLV AOLV OLV/PM AOLV/PM CLV/PM EZOLV </div> Sets the maximum possible output from the PID controller as a percentage of the Maximum Output Frequency.	100.0% (0.0 - 100.0%)

■ b5-07: PID Offset Adjustment

No. (Hex.)	Name	Description	Default (Range)
b5-07 (01AB) RUN	PID Offset Adjustment	<div style="display: flex; justify-content: space-between; gap: 5px;"> V/f CL-V/f OLV CLV AOLV OLV/PM AOLV/PM CLV/PM EZOLV </div> Sets the offset for the PID control output as a percentage of the Maximum Output Frequency.	0.0% (-100.0 - +100.0%)

■ b5-08: PID Primary Delay Time Constant

No. (Hex.)	Name	Description	Default (Range)
b5-08 (01AC) RUN Expert	PID Primary Delay Time Constant	<div style="display: flex; justify-content: space-between; gap: 5px;"> V/f CL-V/f OLV CLV AOLV OLV/PM AOLV/PM CLV/PM EZOLV </div> Sets the primary delay time constant for the PID control output. Usually it is not necessary to change this setting.	0.00 s (0.00 - 10.00 s)

Prevents resonance if there is a large quantity of mechanical friction or if rigidity is unsatisfactory. Set the value larger than the resonant frequency cycle. A value that is too large will decrease drive responsiveness.

■ b5-09: PID Output Level Selection

No. (Hex.)	Name	Description	Default (Range)
b5-09 (01AD)	PID Output Level Selection	<div style="display: flex; justify-content: space-between; gap: 5px;"> V/f CL-V/f OLV CLV AOLV OLV/PM AOLV/PM CLV/PM EZOLV </div> Sets the polarity of the PID output.	0 (0, 1)

Use this parameter in applications that decrease the drive output frequency when you increase the PID setpoint.

0 : Normal Output (Direct Acting)

A positive PID input increases the PID output (direct acting).

1 : Reverse Output (Reverse Acting)

A positive PID input decreases the PID output (reverse acting).

■ b5-10: PID Output Gain Setting

No. (Hex.)	Name	Description	Default (Range)
b5-10 (01AE) RUN	PID Output Gain Setting	<div style="display: flex; justify-content: space-between; gap: 5px;"> V/f CL-V/f OLV CLV AOLV OLV/PM AOLV/PM CLV/PM EZOLV </div> Sets the amount of gain to apply to the PID output.	1.00 (0.00 - 25.00)

12.3 b: Application

Applies a gain to the PID output and can help when $b5-01 = 3$ or 4 [$PID\ Mode\ Setting = Fref + PID\ Trim, Fref + PID\ Trim\ (D\ on\ feedback)$].

■ b5-11: PID Output Reverse Selection

No. (Hex.)	Name	Description	Default (Range)
b5-11 (01AF)	PID Output Reverse Selection	<div style="display: flex; gap: 5px;"> V/f CL-V/f OLV CLV AOLV OLV/PM AOLV/PM CLV/PM EZOLV </div> Sets the function that enables and disables reverse motor rotation for negative PID control output.	0 (0, 1)

This parameter is disabled when $b5-01 = 3, 4$ [$PID\ Mode\ Setting = Fref + PID\ Trim, Fref + PID\ Trim\ (D\ on\ feedback)$]. There is no limit for PID output (PID output can be positive or negative). Operates the same as setting "1: Enabled: Negative lower limit".

0 : Lower Limit is Zero

When PID output is negative, PID output is limited to 0 and drive output is shut off.

1 : Negative Output Accepted

When the PID output is negative, the motor will rotate in reverse. When $b1-04 = 1$ [$Reverse\ Operation\ Selection = Reverse\ Disabled$], the lower limit is 0.

■ b5-12: Feedback Loss Detection Select

No. (Hex.)	Name	Description	Default (Range)
b5-12 (01B0)	Feedback Loss Detection Select	<div style="display: flex; gap: 5px;"> V/f CL-V/f OLV CLV AOLV OLV/PM AOLV/PM CLV/PM EZOLV </div> Sets the drive response to PID Feedback Low/High. Sets drive operation after the drive detects PID feedback Low/High.	0 (0 - 5)

0 : Digital Out Only, Always Detect

The MFDO terminal set for *PID Feedback Low* or *PID Feedback High* [$H2-01\ to\ H2-03 = 3E, 3F$] activates. When the drive detects Feedback Low/High, the keypad will not show a minor fault/alarm and the drive will continue operation.

When the feedback signal is less than the level set in $b5-13$ [$PID\ Feedback\ Loss\ Detection\ Lvl$] for longer than the time set in $b5-14$ [$PID\ Feedback\ Loss\ Detection\ Time$], the MFDO terminal set for a *PID Feedback Low* activates.

When the feedback signal is more than the level set in $b5-36$ [$PID\ High\ Feedback\ Detection\ Lvl$] for longer than the time set in $b5-37$ [$PID\ High\ Feedback\ Detection\ Time$] the MFDO terminal set for a *PID Feedback High* activates.

When the feedback value is not in the detection range, the drive resets the MFDO.

1 : Alarm + Digital Out, Always Det

The drive detects *FbL* [$PID\ Feedback\ Loss$] and *FbH* [$Excessive\ PID\ Feedback$]. The MFDO terminal set for *PID Feedback Low* or *PID Feedback High* [$H2-01\ to\ H2-03 = 3E, 3F$] activates. The output terminal set for *Alarm* [$H2-01\ to\ H2-03 = 10$] activates and the drive continues operation.

When the feedback signal is less than the level set in $b5-13$ for longer than the time set in $b5-14$, the MFDO terminal set for a *PID Feedback Low* activates.

When the feedback signal is less than the level set in $b5-36$ for longer than the time set in $b5-37$, the MFDO terminal set for a *PID Feedback High* activates.

When the feedback value is not in the detection range, the drive resets the MFDO.

2 : Fault + Digital Out, Always Det

The drive detects *FbL* and *FbH*. Fault relay output terminal MA-MC activates, MB-MC turns OFF, and the motor coasts to stop.

When the feedback signal is less than the level set in $b5-13$ for the time set in $b5-14$, the drive detects *FbL*.

When the feedback signal is less than the level set in $b5-36$ for the time set in $b5-37$, the drive detects *FbH*.

3 : Digital Out Only, @ PID Enable

The MFDO terminal set for *PID Feedback Low* or *PID Feedback High* activates. The keypad will not show a minor fault/alarm. The drive continues operation.

When the MFDI terminal set to *PID Disable* [$H1-xx = 19$] activates, the drive disables fault detection.

4 : Alarm + Digital Out, @PID Enable

The drive detects *FbL* and *FbH*. The MFDO terminal set for *PID Feedback Low* or *PID Feedback High* activates. The output terminal set for *Alarm [H2-01 to H2-03 = 10]* activates and the drive continues operation.

When the MFDI terminal set to *PID Disable [H1-xx = 19]* activates, the drive disables fault detection.

5 : Fault + Digital Out, @PID Enable

The drive detects *FbL* and *FbH*. Fault relay output terminal MA-MC activates, MB-MC turns OFF, and the drive coasts to stop.

When the MFDI terminal set to *PID Disable [H1-xx = 19]* activates, the drive disables fault detection.

■ b5-13: PID Feedback Loss Detection Lvl

No. (Hex.)	Name	Description	Default (Range)
b5-13 (01B1)	PID Feedback Loss Detection Lvl	<div style="display: flex; justify-content: space-between; gap: 5px;"> V/f CL-V/f OLV CLV AOLV OLV/PM AOLV/PM CLV/PM EZOLV </div> Sets the level that triggers <i>PID Feedback Loss [FbL]</i> detection as a percentage of the Maximum Output Frequency.	0% (0 - 100%)

The drive detects *PID Feedback Loss [FbL]* when the feedback signal decreases to less than the level set in *b5-13* for longer than the time set in *b5-14 [PID Feedback Loss Detection Time]*.

■ b5-14: PID Feedback Loss Detection Time

No. (Hex.)	Name	Description	Default (Range)
b5-14 (01B2)	PID Feedback Loss Detection Time	<div style="display: flex; justify-content: space-between; gap: 5px;"> V/f CL-V/f OLV CLV AOLV OLV/PM AOLV/PM CLV/PM EZOLV </div> Sets the length of time that PID Feedback must be less than <i>b5-13 [PID Feedback Loss Detection Lvl]</i> to detect <i>PID Feedback Loss [FbL]</i> .	1.0 s (0.0 - 25.5 s)

■ b5-15: PID Sleep Function Start Level

No. (Hex.)	Name	Description	Default (Range)
b5-15 (01B3)	PID Sleep Function Start Level	<div style="display: flex; justify-content: space-between; gap: 5px;"> V/f CL-V/f OLV CLV AOLV OLV/PM AOLV/PM CLV/PM EZOLV </div> Sets the output level that triggers the PID Sleep function.	Determined by A1-02 (0.0 - 590.0)

The drive goes into Sleep mode when the PID output or frequency reference is less than *b5-15* for longer than the time set to *b5-16 [PID Sleep Delay Time]*. The drive continues operation when the PID output or frequency reference is more than *b5-15* for longer than the time set to *b5-16*.

■ b5-16: PID Sleep Delay Time

No. (Hex.)	Name	Description	Default (Range)
b5-16 (01B4)	PID Sleep Delay Time	<div style="display: flex; justify-content: space-between; gap: 5px;"> V/f CL-V/f OLV CLV AOLV OLV/PM AOLV/PM CLV/PM EZOLV </div> Sets a delay time to start or stop the PID Sleep function.	0.0 s (0.0 - 25.5 s)

■ b5-17: PID Accel/Decel Time

No. (Hex.)	Name	Description	Default (Range)
b5-17 (01B5) RUN	PID Accel/Decel Time	<div style="display: flex; justify-content: space-between; gap: 5px;"> V/f CL-V/f OLV CLV AOLV OLV/PM AOLV/PM CLV/PM EZOLV </div> Raises or lowers the PID setpoint using the acceleration and deceleration times set to the drive. This is a soft-starter for the PID setpoint.	0.0 s (0.0 - 6000.0 s)

The drive usually uses the acceleration and deceleration times set in *CI-xx [Accel and Decel Times]*, but when PID control is enabled, the drive applies *CI-xx* after PID output. If you frequently change the PID setpoint, the drive responsiveness decreases. When resonance with PID control causes hunting, overshoot, or undershoot, set *b5-17* for longer acceleration and deceleration times.

Decrease *CI-xx* until hunting stops, then use *b5-17* to check the acceleration and deceleration. To enable and disable the setting in *b5-17* through an MFDI terminal, set *PID Soft Starter Disable [H1-xx = 34]*.

■ **b5-18: b5-19 PID Setpoint Selection**

No. (Hex.)	Name	Description	Default (Range)
b5-18 (01DC)	b5-19 PID Setpoint Selection	<div style="display: flex; gap: 5px;"> V/f CL-V/f OLV CLV AOLV OLV/PM AOLV/PM CLV/PM EZOLV </div> Sets the function that enables and disables <i>b5-19 [PID Setpoint Value]</i> .	0 (0, 1)

0 : Disabled

The drive does not use the value set in *b5-19* as the PID setpoint.

1 : Enabled

The drive uses the value set in *b5-19* as the PID setpoint.

■ **b5-19: PID Setpoint Value**

No. (Hex.)	Name	Description	Default (Range)
b5-19 (01DD) RUN	PID Setpoint Value	<div style="display: flex; gap: 5px;"> V/f CL-V/f OLV CLV AOLV OLV/PM AOLV/PM CLV/PM EZOLV </div> Sets the PID setpoint when <i>b5-18 = 1 [b5-19 PID Setpoint Selection = Enabled]</i> .	0.00% (0.00 - 100.00%)

■ **b5-20: PID Unit Selection**

No. (Hex.)	Name	Description	Default (Range)
b5-20 (01E2)	PID Unit Selection	<div style="display: flex; gap: 5px;"> V/f CL-V/f OLV CLV AOLV OLV/PM AOLV/PM CLV/PM EZOLV </div> Sets the number of digits to set and show the PID setpoint.	1 (0 - 3)

Set the units for these parameters and monitors:

- b5-19 [PID Setpoint Value]
- b5-58 [PID Setpoint2]
- b5-59 [PID Setpoint3]
- b5-60 [PID Setpoint4]
- U5-01 [PID Feedback]
- U5-04 [PID Setpoint]
- U5-99 [PID Setpoint Command]

0 : 0.01Hz units

The drive uses 0.01 Hz units.

1 : 0.01% units

The drive uses 0.01% units. Set the value as a percentage of *E1-04 [Maximum Output Frequency]*.

2 : rev/min

The drive uses 1 rev/min unit. Set *E2-04, E4-04, or E5-04 [Motor Pole Count]*.

3 : User Units

The drive uses the units set in *b5-38 [PID User Unit Display Scaling]* and *b5-39 [PID User Unit Display Digits]* to show the PID setpoint in *U5-01, U5-04, U5-06 [PID Feedback, PID Setpoint, PID Fdbk-Diff PID Fdbk]*.

■ **b5-34: PID Output Lower Limit Level**

No. (Hex.)	Name	Description	Default (Range)
b5-34 (019F) RUN	PID Output Lower Limit Level	<div style="display: flex; gap: 5px;"> V/f CL-V/f OLV CLV AOLV OLV/PM AOLV/PM CLV/PM EZOLV </div> Sets the output lower limit for the PID control as a percentage of the Maximum Output Frequency.	0.0% (-100.0 - +100.0%)

Use a lower limit to keep PID control output from dropping below a fixed level.

Set this parameter to 0.0% to disable this function.

■ b5-35: PID Input Limit Level

No. (Hex.)	Name	Description	Default (Range)
b5-35 (01A0) RUN	PID Input Limit Level	V/f CL-V/f OLV CLV AOLV OLV/PM AOLV/PM CLV/PM EZOLV Sets the output upper limit for the PID control as a percentage of the Maximum Output Frequency.	1000.0% (0.0 - 1000.0%)

A large input value for PID control makes a high output. The drive applies this limit to the negative and positive domains.

■ b5-36: PID High Feedback Detection Lvl

No. (Hex.)	Name	Description	Default (Range)
b5-36 (01A1)	PID High Feedback Detection Lvl	V/f CL-V/f OLV CLV AOLV OLV/PM AOLV/PM CLV/PM EZOLV Sets the level that triggers <i>Excessive PID Feedback [FbH]</i> as a percentage of the Maximum Output Frequency.	100% (0 - 100%)

When the feedback signal increases to more than the level set in *b5-36* for the time set in *b5-37* [*PID High Feedback Detection Time*], the drive will detect *Excessive PID Feedback [FbH]*.

■ b5-37: PID High Feedback Detection Time

No. (Hex.)	Name	Description	Default (Range)
b5-37 (01A2)	PID High Feedback Detection Time	V/f CL-V/f OLV CLV AOLV OLV/PM AOLV/PM CLV/PM EZOLV Sets the length of time that the PID feedback signal must be more than the level set in <i>b5-36</i> [<i>PID Feedback High Detection Lvl</i>] to cause <i>Excessive PID Feedback [FbH]</i> .	1.0 s (0.0 - 25.5 s)

■ b5-38: PID User Unit Display Scaling

No. (Hex.)	Name	Description	Default (Range)
b5-38 (01FE)	PID User Unit Display Scaling	V/f CL-V/f OLV CLV AOLV OLV/PM AOLV/PM CLV/PM EZOLV Sets the value that the drive sets or shows as the PID setpoint when at the maximum output frequency.	Determined by b5-20 (1 - 60000)

The drive uses this parameter and *b5-39* [*PID Setpoint Display Digits*] together.

When *b5-20* = 3 [*PID Unit Selection = User Units*], the drive applies user-set PID setpoint and display units to these parameters and monitors:

- b5-19 [PID Setpoint Value]
- b5-58 [PID Setpoint2]
- b5-59 [PID Setpoint3]
- b5-60 [PID Setpoint4]
- U5-01 [PID Feedback]
- U5-04 [PID Setpoint]
- U5-99 [PID Setpoint Command]

■ b5-39: PID User Unit Display Digits

No. (Hex.)	Name	Description	Default (Range)
b5-39 (01FF)	PID User Unit Display Digits	V/f CL-V/f OLV CLV AOLV OLV/PM AOLV/PM CLV/PM EZOLV Sets the number of digits to set and show the PID setpoint.	Determined by b5-20 (0 - 3)

The drive uses this parameter and *b5-38* [*PID Setpoint User Display*] together.

When *b5-20* = 3 [*PID Unit Selection = User Units*], the drive applies user-set PID setpoint and display units to these parameters and monitors:

- b5-19 [PID Setpoint Value]
- b5-58 [PID Setpoint2]

12.3 b: Application

- b5-59 [PID Setpoint3]
- b5-60 [PID Setpoint4]
- U5-01 [PID Feedback]
- U5-04 [PID Setpoint]
- U5-99 [PID Setpoint Command]

0 : No Decimal Places (XXXXX)

1 : One Decimal Places (XXXX.X)

2 : Two Decimal Places (XXX.XX)

3 : Three Decimal Places (XX.XXX)

■ b5-40: Frequency Reference Monitor @PID

No. (Hex.)	Name	Description	Default (Range)
b5-40 (017F)	Frequency Reference Monitor @PID	<input type="checkbox"/> V/f <input type="checkbox"/> CL-V/f <input type="checkbox"/> OLV <input type="checkbox"/> CLV <input type="checkbox"/> AOLV <input type="checkbox"/> OL/PM <input type="checkbox"/> AOL/PM <input type="checkbox"/> CLV/PM <input type="checkbox"/> EZOLV Sets the contents for monitor <i>U1-01</i> [Frequency Reference] in PID control.	0 (0, 1)

0 : U1-01 Includes PID Output

Monitor *U1-01* shows the frequency reference that was increased or decreased by the PID output.

1 : U1-01 Excludes PID Output

Monitor *U1-01* shows the actual frequency reference.

■ b5-47: PID Trim Mode Output Reverse Sel

No. (Hex.)	Name	Description	Default (Range)
b5-47 (017D)	PID Trim Mode Output Reverse Sel	<input type="checkbox"/> V/f <input type="checkbox"/> CL-V/f <input type="checkbox"/> OLV <input type="checkbox"/> CLV <input type="checkbox"/> AOLV <input type="checkbox"/> OL/PM <input type="checkbox"/> AOL/PM <input type="checkbox"/> CLV/PM <input type="checkbox"/> EZOLV Sets reverse motor rotation when the PID control output is negative.	1 (0, 1)

This parameter is enabled when $b5-01 = 3$ or 4 [PID Mode Setting = $F_{ref} + \text{PID Trim}$, $F_{ref} + \text{PID Trim}$ (D on feedback)].

0 : Lower Limit is Zero

When PID output is negative, PID output is limited to 0 and drive output is shut off.

1 : Negative Output Accepted

When the PID output is negative, the motor will rotate in reverse.

■ b5-53: PID Integrator Ramp Limit

No. (Hex.)	Name	Description	Default (Range)
b5-53 (0B8F) RUN	PID Integrator Ramp Limit	<input type="checkbox"/> V/f <input type="checkbox"/> CL-V/f <input type="checkbox"/> OLV <input type="checkbox"/> CLV <input type="checkbox"/> AOLV <input type="checkbox"/> OL/PM <input type="checkbox"/> AOL/PM <input type="checkbox"/> CLV/PM <input type="checkbox"/> EZOLV Sets the responsiveness of PID control when the PID feedback changes quickly.	0.0 Hz (0.0 - 10.0 Hz)

Note:

- This parameter is disabled when set to 0.0 Hz.
- When $b5-53 > 0.0$ Hz and the drive enables the integrator ramp limit, the PID integrator value limit is the range set by the output frequency $\pm b5-53$.
- When the PID feedback changes quickly, gradually decrease this parameter in 0.1 Hz increments to decrease the speed of the response of PID control.

■ b5-55: PID Feedback Monitor Selection

No. (Hex.)	Name	Description	Default (Range)
b5-55 (0BE1)	PID Feedback Monitor Selection	<input type="checkbox"/> V/f <input type="checkbox"/> CL-V/f <input type="checkbox"/> OLV <input type="checkbox"/> CLV <input type="checkbox"/> AOLV <input type="checkbox"/> OL/PM <input type="checkbox"/> AOL/PM <input type="checkbox"/> CLV/PM <input type="checkbox"/> EZOLV Sets the monitor (<i>Ux-xx</i>) used as the PID Feedback. Set the <i>x-xx</i> part of the <i>Ux-xx</i> [Monitor].	000 (000 - 999)

Note:

- You cannot select *parameter U5-xx*.
- This parameter is disabled when set to 000.

■ b5-56: PID Feedback Monitor Gain

No. (Hex.)	Name	Description	Default (Range)
b5-56 (0BE2)	PID Feedback Monitor Gain	V/f CL-V/f OLV CLV AOLV OLV/PM AOLV/PM CLV/PM EZOLV Sets the gain for the monitor set in b5-55 [PID Feedback Monitor Selection].	1.00 (0.00 - 10.00)

■ b5-57: PID Feedback Monitor Bias

No. (Hex.)	Name	Description	Default (Range)
b5-57 (11DD)	PID Feedback Monitor Bias	V/f CL-V/f OLV CLV AOLV OLV/PM AOLV/PM CLV/PM EZOLV Sets the bias for the monitor specified in b5-55 [PID Feedback Monitor Selection].	0.00 (-10.00 - +10.00)

■ b5-58 to b5-60: PID Setpoints 2 to 4

No. (Hex.)	Name	Description	Default (Range)
b5-58 to b5-60: (1182 - 1184) RUN	PID Setpoints 2 to 4	V/f CL-V/f OLV CLV AOLV OLV/PM AOLV/PM CLV/PM EZOLV Sets the PID setpoint when H1-xx = 3E or 3F [MFDI Function Selection = PID Setpoint Selection 1/2]. This value is a percentage of the maximum output frequency.	0.00% (0.00 - 100.00%)

Table 12.28 shows how the different MFDI H1-xx values (3E and 3F) have an effect on the PID setpoint value.

Table 12.28 Switching of MFDI and PID Setpoint Value

H1-xx = 3E	H1-xx = 3F	PID Setpoint Value
OFF	OFF	No switch
ON	OFF	b5-58 [PID Setpoint2]
OFF	ON	b5-59 [PID Setpoint3]
ON	ON	b5-60 [PID Setpoint4]

■ b5-61: PID Trim Mode Lower Limit Sel

No. (Hex.)	Name	Description	Default (Range)
b5-61 (119A)	PID Trim Mode Lower Limit Sel	V/f CL-V/f OLV CLV AOLV OLV/PM AOLV/PM CLV/PM EZOLV Sets the function that adjusts the PID output in relation to the frequency reference.	0 (0, 1)

0 : Disabled

Does not adjust the PID output with the frequency reference.

1 : Enabled

Adjusts the PID output in relation to the frequency reference. The setting value of b5-62 [PID Trim Mode Lower Limit Value] sets the lower limit of the post-adjustment value. The maximum output frequency sets the upper limit.

Note:

- Set b5-01 = 3, 4, 7, or 8 to enable this parameter.
- When b5-61 = 1, you can use this formula to adjust PID output proportional to the frequency reference:

$$U5-03 = U5-03 \times \left| \frac{Fref}{Fmax} \right|^{*1}$$

U5-03 [PID Output], Fref [Frequency Reference], and Fmax [Maximum Output Frequency]

*1 Lower limit = b5-62, Upper limit = Maximum output frequency

■ b5-62: PID Trim Mode Lower Limit Value

No. (Hex.)	Name	Description	Default (Range)
b5-62 (119B)	PID Trim Mode Lower Limit Value	<input type="checkbox"/> V/f <input type="checkbox"/> CL-V/f <input type="checkbox"/> OLV <input type="checkbox"/> CLV <input type="checkbox"/> AOLV <input type="checkbox"/> OLVP/M <input type="checkbox"/> AOLVP/M <input type="checkbox"/> CLVP/M <input type="checkbox"/> EZOLV Sets the PID Trim Mode Lower Limit Value as a percentage of the maximum output frequency.	0.00% (0.00 - 100.00%)

Note:

Set *b5-01* = 3, 4, 7, or 8 to enable this parameter.

■ b5-63: PID Differential FB Monitor Sel

No. (Hex.)	Name	Description	Default (Range)
b5-63 (119C)	PID Differential FB Monitor Sel	<input type="checkbox"/> V/f <input type="checkbox"/> CL-V/f <input type="checkbox"/> OLV <input type="checkbox"/> CLV <input type="checkbox"/> AOLV <input type="checkbox"/> OLVP/M <input type="checkbox"/> AOLVP/M <input type="checkbox"/> CLVP/M <input type="checkbox"/> EZOLV Selects the monitor (<i>Ux-xx</i>) used as the PID Differential Feedback. Set the <i>x-xx</i> part of the <i>Ux-xx</i> [Monitor].	000 (000 - 999)

Note:

- You cannot select parameter *U5-xx*.
- This parameter is disabled when set to 000.

■ b5-64: PID Differential FB Monitor Gain

No. (Hex.)	Name	Description	Default (Range)
b5-64 (119D)	PID Differential FB Monitor Gain	<input type="checkbox"/> V/f <input type="checkbox"/> CL-V/f <input type="checkbox"/> OLV <input type="checkbox"/> CLV <input type="checkbox"/> AOLV <input type="checkbox"/> OLVP/M <input type="checkbox"/> AOLVP/M <input type="checkbox"/> CLVP/M <input type="checkbox"/> EZOLV Sets the gain for the monitor specified in <i>b5-63</i> [PID Differential FB Monitor Sel].	1.00 (0.00 - 10.00)

■ b5-65: PID Differential FB Monitor Bias

No. (Hex.)	Name	Description	Default (Range)
b5-65 (119F)	PID Differential FB Monitor Bias	<input type="checkbox"/> V/f <input type="checkbox"/> CL-V/f <input type="checkbox"/> OLV <input type="checkbox"/> CLV <input type="checkbox"/> AOLV <input type="checkbox"/> OLVP/M <input type="checkbox"/> AOLVP/M <input type="checkbox"/> CLVP/M <input type="checkbox"/> EZOLV Sets the bias for the monitor specified in <i>b5-63</i> [PID Differential FB Monitor Sel].	0.00 (-10.00 - +10.00)

■ b5-66: PID Feedback Monitor Level

No. (Hex.)	Name	Description	Default (Range)
b5-66 (11DE)	PID Feedback Monitor Level	<input type="checkbox"/> V/f <input type="checkbox"/> CL-V/f <input type="checkbox"/> OLV <input type="checkbox"/> CLV <input type="checkbox"/> AOLV <input type="checkbox"/> OLVP/M <input type="checkbox"/> AOLVP/M <input type="checkbox"/> CLVP/M <input type="checkbox"/> EZOLV Sets the signal level for the monitor specified in <i>b5-55</i> [PID Feedback Monitor Selection].	0 (0, 1)

0 : Absolute

1 : Bi-directional (+/-)

■ b5-67: PID Differential FB Monitor Lvl

No. (Hex.)	Name	Description	Default (Range)
b5-67 (11DF)	PID Differential FB Monitor Lvl	<input type="checkbox"/> V/f <input type="checkbox"/> CL-V/f <input type="checkbox"/> OLV <input type="checkbox"/> CLV <input type="checkbox"/> AOLV <input type="checkbox"/> OLVP/M <input type="checkbox"/> AOLVP/M <input type="checkbox"/> CLVP/M <input type="checkbox"/> EZOLV Sets the signal level for the monitor specified in <i>b5-63</i> [PID Differential FB Monitor Sel].	0 (0, 1)

0 : Absolute

1 : Bi-directional (+/-)

■ b5-89: Sleep Method Selection

No. (Hex.)	Name	Description	Default (Range)
b5-89 (0B89) RUN	Sleep Method Selection	<input type="checkbox"/> V/f <input type="checkbox"/> CL-V/f <input type="checkbox"/> OLV <input type="checkbox"/> CLV <input type="checkbox"/> AOLV <input type="checkbox"/> OLVP/M <input type="checkbox"/> AOLVP/M <input type="checkbox"/> CLVP/M <input type="checkbox"/> EZOLV Sets sleep and wake up operation when using PID.	0 (0, 1)

0 : Standard**1 : EZ Sleep/Wake-up****■ b5-90: EZ Sleep Unit**

No. (Hex.)	Name	Description	Default (Range)
b5-90 (0B90)	EZ Sleep Unit	V/f CL-V/f OLV CLV AOLV OLV/PM AOLV/PM CLV/PM EZOLV Sets the measurement units for b5-91 [EZ Sleep Minimum Speed] and b5-92 [EZ Sleep Level].	0 (0, 1)

0 : 0.1Hz units**1 : rev/min****■ b5-91: EZ Sleep Minimum Speed**

No. (Hex.)	Name	Description	Default (Range)
b5-91 (0B91) RUN	EZ Sleep Minimum Speed	V/f CL-V/f OLV CLV AOLV OLV/PM AOLV/PM CLV/PM EZOLV Sets the minimum speed for the EZ Sleep/Wakeup function. This parameter uses the largest value from b5-91, b5-34 [PID Output Lower Limit Level], and d2-02 [Frequency Reference Lower Limit].	0.0 Hz or 0 min ⁻¹ (r/min) (0.0 to 590.0 Hz or 0 to 35400 min ⁻¹ (r/min))

Note:

The value of b5-90 [EZ Sleep Unit] sets the units. When b5-90 changes, this parameter does not automatically update. Set this parameter again after you change b5-90 is changed.

■ b5-92: EZ Sleep Level

No. (Hex.)	Name	Description	Default (Range)
b5-92 (0B92) RUN	EZ Sleep Level	V/f CL-V/f OLV CLV AOLV OLV/PM AOLV/PM CLV/PM EZOLV Sets the value that the output frequency or motor speed must be less than for longer than b5-93 [EZ Sleep Time] to enter Sleep Mode.	0.0 Hz or 0 min ⁻¹ (r/min) (0.0 to 590.0 Hz or 0 to 35400 min ⁻¹ (r/min))

Note:

When b5-90 [EZ Sleep Unit] changes, this parameter does not automatically update. Set this parameter again after you change b5-90.

■ b5-93: EZ Sleep Time

No. (Hex.)	Name	Description	Default (Range)
b5-93 (0B93) RUN	EZ Sleep Time	V/f CL-V/f OLV CLV AOLV OLV/PM AOLV/PM CLV/PM EZOLV Sets the length of time that the output frequency or motor speed must be less than b5-92 [EZ Sleep Level] to enter Sleep Mode.	5.0 s (0.0 - 1000.0 s)

■ b5-94: EZ Sleep Wake-up Level

No. (Hex.)	Name	Description	Default (Range)
b5-94 (0B94) RUN	EZ Sleep Wake-up Level	V/f CL-V/f OLV CLV AOLV OLV/PM AOLV/PM CLV/PM EZOLV Sets the level at which the drive resumes operation when exiting Sleep Mode.	0.00% (0.00 - 600.00%)

Note:

The values of b5-20 [PID Unit Selection], b5-38 [PID User Unit Display Scaling], and b5-39 [PID User Unit Display Digits] set the units. When b5-20, b5-38, and b5-39 change, this parameter does not automatically update. Set this parameter again after you change b5-20, b5-38, and b5-39 are changed.

- When b5-95 = 0 [EZ Sleep Wake-up Mode = Absolute]:
When b5-09 = 0 [PID Output Level Selection = Normal Output (Direct Acting)], and the PID Feedback [H3-xx = B] is less than the value of b5-94 for a time longer than the value of b5-96 [EZ Sleep Wake-up Time], the drive will exit sleep and start operation again. When b5-09 = 1 [Reverse Output (Reverse Acting)], and the PID feedback is more than setting value of b5-94 for a time longer than the setting value of b5-96, the drive will exit sleep and start operation again.
- When b5-95 = 1 [Setpoint Delta]:

When $b5-09 = 0$, and the PID feedback is less than the value of “PID setpoint value - $b5-94$ ” for a time longer than the value of $b5-96$, the drive will exit sleep and start operation again. When $b5-09 = 1$, and the PID feedback is more than the value of “PID setpoint value + $b5-94$ ” for a time longer than the setting value of $b5-96$, the drive will exit sleep and start operation again.

■ b5-95: EZ Sleep Wake-up Mode

No. (Hex.)	Name	Description	Default (Range)
b5-95 (0B95)	EZ Sleep Wake-up Mode	V/f CL-V/f OLV CLV AOLV OLV/PM AOLV/PM CLV/PM EZOLV Sets the wake-up mode to use when exiting Sleep Mode.	0 (0, 1)

0 : Absolute

1 : Setpoint Delta

■ b5-96: EZ Sleep Wake-up Time

No. (Hex.)	Name	Description	Default (Range)
b5-96 (0B96) RUN	EZ Sleep Wake-up Time	V/f CL-V/f OLV CLV AOLV OLV/PM AOLV/PM CLV/PM EZOLV Sets the EZ Wake-up time.	1.0 s (0.0 - 1000.0 s)

When the PID feedback is less than the value of $b5-94$ [EZ Sleep Wake-up Level] continuously for the time set in $b5-96$, the drive will exit sleep and start operation again.

◆ b6: Dwell Function

The Dwell function momentarily holds the output frequency at start and stop.

This prevents motor speed loss when you start and stop heavy loads. The Dwell function is also enabled when backlash on the machine side causes sudden movement at the start of acceleration and deceleration.

At the start of acceleration, the drive uses the output frequency and acceleration time set for the Dwell function to automatically operate at low speed to minimize the effects of backlash. Then, the drive can accelerate again. The Dwell function operates the same for deceleration.

For conveyor applications, the Dwell function also lets the drive interlock the output frequency and a delay time for the holding brake on the load side.

The Dwell function momentarily stops during acceleration to prevent a PM motor from stepping out. [Figure 12.40](#) shows how the Dwell function works.

Note:

When you use the Dwell function at stop, set $b1-03 = 0$ [Stopping Method Selection = Ramp to Stop].

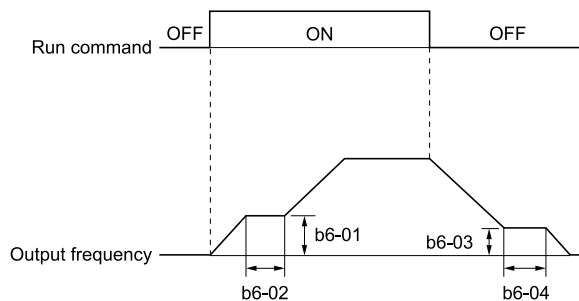

Figure 12.40 Time Chart for the Dwell Function at Start/Stop

■ b6-01: Dwell Reference at Start

No. (Hex.)	Name	Description	Default (Range)
b6-01 (01B6)	Dwell Reference at Start	V/f CL-V/f OLV CLV AOLV OLV/PM AOLV/PM CLV/PM EZOLV Sets the output frequency that the drive will hold momentarily when the motor starts.	0.0 (Determined by A1-02)

When the drive accelerates to the output frequency set in *b6-01*, it holds that frequency for the time set in *b6-02* [*Dwell Time at Start*], and starts to accelerate again.

■ b6-02: Dwell Time at Start

No. (Hex.)	Name	Description	Default (Range)
b6-02 (01B7)	Dwell Time at Start	V/f CL-V/f OLV CLV AOLV OLV/PM AOLV/PM CLV/PM EZOLV Sets the length of time that the drive will hold the output frequency when the motor starts.	0.0 s (0.0 - 10.0 s)

■ b6-03: Dwell Reference at Stop

No. (Hex.)	Name	Description	Default (Range)
b6-03 (01B8)	Dwell Reference at Stop	V/f CL-V/f OLV CLV AOLV OLV/PM AOLV/PM CLV/PM EZOLV Sets the output frequency that the drive will hold momentarily when ramping to stop the motor.	0.0 (Determined by A1-02)

When the drive decelerates to the output frequency set in *b6-03*, it holds that frequency for the time set in *b6-04* [*Dwell Time at Stop*] and starts to decelerate again.

■ b6-04: Dwell Time at Stop

No. (Hex.)	Name	Description	Default (Range)
b6-04 (01B9)	Dwell Time at Stop	V/f CL-V/f OLV CLV AOLV OLV/PM AOLV/PM CLV/PM EZOLV Sets the length of time for the drive to hold the output frequency when ramping to stop the motor.	0.0 s (0.0 - 10.0 s)

◆ b7: Droop Control

Droop control automatically balances the load level between two motors that operate the same load.

Droop control decreases motor speed as the load changes. You must enable the Droop control function for each motor it is operating.

To decrease motor speed, the Droop control function decreases the speed reference when an increase in the load increases the torque reference. To increase motor speed, the Droop control function increases the speed reference when a decrease in the load decreases the torque reference. The Droop control function adjusts motor speed as the torque reference changes to balance the load between the motors.

Note:

When you use Droop control, set *n5-01* = 0 [*Feed Forward Control Selection* = Disabled].

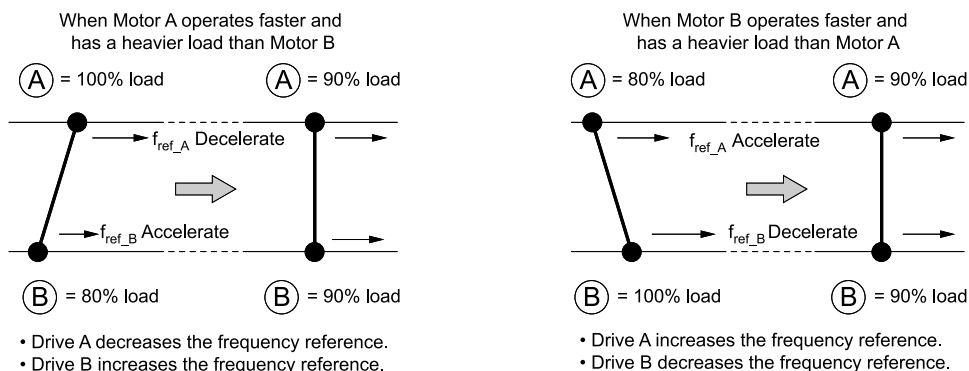

Figure 12.41 Droop Control Application

■ b7-01: Droop Control Gain

No. (Hex.)	Name	Description	Default (Range)
b7-01 (01CA) RUN	Droop Control Gain	<div style="display: flex; justify-content: space-between; font-size: small;"> V/f CL-V/f OLV CLV AOLV OLV/PM AOLV/PM CLV/PM EZOLV </div> <p>Sets the amount of deceleration when the torque reference is at 100% as a percentage of <i>E1-04</i> [Maximum Output Frequency].</p>	0.0% (0.0 - 100.0%)

To disable Droop control, set this parameter to 0.0%.

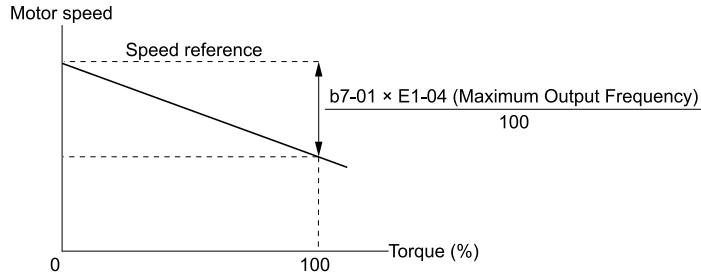

Figure 12.42 Droop Control Gain

■ b7-02: Droop Control Delay Time

No. (Hex.)	Name	Description	Default (Range)
b7-02 (01CB) RUN	Droop Control Delay Time	<div style="display: flex; justify-content: space-between; font-size: small;"> V/f CL-V/f OLV CLV AOLV OLV/PM AOLV/PM CLV/PM EZOLV </div> <p>Sets the responsiveness of Droop control. Decrease this setting when drive response is slow. Increase this setting when hunting or oscillation occur.</p>	0.05 s (0.03 - 2.00 s)

■ b7-03: Droop Control Limit Selection

No. (Hex.)	Name	Description	Default (Range)
b7-03 (017E)	Droop Control Limit Selection	<div style="display: flex; justify-content: space-between; font-size: small;"> V/f CL-V/f OLV CLV AOLV OLV/PM AOLV/PM CLV/PM EZOLV </div> <p>Sets the Droop control limit function.</p>	1 (0, 1)

0 : Disabled

1 : Enabled

◆ b8: Energy Saving

Energy-saving control improves overall system operating efficiency by operating the motor at its most efficient level. Set *b8-01* and the following parameters according to the control mode and the motor.

- Set parameters *b8-04*, *b8-05*, and *b8-06* when using V/f Control or Closed Loop V/f Control.
- Set parameters *b8-02*, *b8-03* when using vector control with an induction motor.
- Set parameters *b8-16*, *b8-17* when using a PM motor.

Note:

- Energy-saving control is not appropriate for applications with sudden changes in the load, or applications driving heavy loads such as a traverse car application.
- Energy-saving control maximizes operation based on precise motor data set to the drive. Be sure to perform Auto-Tuning and enter the correct information about the motor before using the Energy-saving control.

■ b8-01: Energy Saving Control Selection

No. (Hex.)	Name	Description	Default (Range)
b8-01 (01CC)	Energy Saving Control Selection	<div style="display: flex; justify-content: space-between; font-size: small;"> V/f CL-V/f OLV CLV AOLV OLV/PM AOLV/PM CLV/PM EZOLV </div> <p>Sets the Energy-saving control function.</p>	0 (0 - 2)

0 : Disabled

1 : Enabled**2 : Automatic Optimization****Note:**

Setting 2 is available only when $A1-02 = 6, 7$ [Control Method Selection = AOLV/PM, CLV/PM] and in Expert Mode.

■ b8-02: Energy Saving Gain

No. (Hex.)	Name	Description	Default (Range)
b8-02 (01CD) RUN Expert	Energy Saving Gain	<div style="display: flex; justify-content: space-between; font-size: 0.8em; margin-bottom: 5px;"> V/f CL-V/f OLV CLV AOLV OLV/PM AOLV/PM CLV/PM EZOLV </div> Sets the gain for Energy-saving control.	Determined by A1-02 (0.0 - 10.0)

Increase the setting value to increase energy saving. If the setting value is too large, the motor will stall.

■ b8-03: Energy Saving Filter Time

No. (Hex.)	Name	Description	Default (Range)
b8-03 (01CE) RUN Expert	Energy Saving Filter Time	<div style="display: flex; justify-content: space-between; font-size: 0.8em; margin-bottom: 5px;"> V/f CL-V/f OLV CLV AOLV OLV/PM AOLV/PM CLV/PM EZOLV </div> Sets the responsiveness for Energy-saving control.	Determined by A1-02 , C6-01 and o2-04 (0.00 - 10.00 s)

Decrease the setting value to increase responsiveness. If the setting value is too low, operation will not be stable.

■ b8-04: Energy Saving Coefficient Value

No. (Hex.)	Name	Description	Default (Range)
b8-04 (01CF) Expert	Energy Saving Coefficient Value	<div style="display: flex; justify-content: space-between; font-size: 0.8em; margin-bottom: 5px;"> V/f CL-V/f OLV CLV AOLV OLV/PM AOLV/PM CLV/PM EZOLV </div> Sets the Energy-saving control coefficient to maintain maximum motor efficiency. The default setting is for Yaskawa motors.	Determined by C6-01, E2-11, and o2-04 (0.00 - 655.00)

When you use a motor from a different manufacturer, increase the setting value in 5% increments to find the minimum value for $U1-08$ [Output Power] at light loads.

When you decrease the setting value, it decreases the output voltage and decreases power consumption. If the setting value is too low, the motor will stall.

Note:

When you do Rotational Auto-Tuning, the drive will automatically set the energy-saving coefficient.

■ b8-05: Power Detection Filter Time

No. (Hex.)	Name	Description	Default (Range)
b8-05 (01D0) Expert	Power Detection Filter Time	<div style="display: flex; justify-content: space-between; font-size: 0.8em; margin-bottom: 5px;"> V/f CL-V/f OLV CLV AOLV OLV/PM AOLV/PM CLV/PM EZOLV </div> Sets the time constant to measure output power.	20 ms (0 - 2000 ms)

Decrease the setting value to increase responsiveness to load changes. If you set the value too low during operation at light loads, motor speed is not stable.

■ b8-06: Search Operation Voltage Limit

No. (Hex.)	Name	Description	Default (Range)
b8-06 (01D1) Expert	Search Operation Voltage Limit	<div style="display: flex; justify-content: space-between; font-size: 0.8em; margin-bottom: 5px;"> V/f CL-V/f OLV CLV AOLV OLV/PM AOLV/PM CLV/PM EZOLV </div> Sets the voltage limit for Search Operation as a percentage of the motor rated voltage.	0% (0 - 100%)

12.3 b: Application

The Search Operation changes the output voltage in small increments to find a setpoint at which the drive can use minimum power to operate.

Set this parameter to 0 to disable Search Operation. This will not disable Energy-saving control.

If the setting value is too low, the motor will stall when loads suddenly increase.

■ b8-16: PM E-Save Coefficient Ki

No. (Hex.)	Name	Description	Default (Range)
b8-16 (01F8) Expert	PM E-Save Coefficient Ki	<div style="display: flex; justify-content: space-between; font-size: 0.8em; margin-bottom: 5px;"> V/f CL-V/f OLV CLV AOLV OLV/PM AOLV/PM CLV/PM EZOLV </div> Sets torque linearity. This parameter uses the Ki value from the motor nameplate. Usually it is not necessary to change this setting.	1.00 (0.00 - 3.00)

When $b8-16 = 1.00$ (default), the drive will automatically calculate and control the energy-saving coefficient. If the motor nameplate has a description for “Ki”, set this parameter to the Ki value.

Do this procedure to prevent oscillation when you set $b8-01 = 1$ [Energy Saving Control Selection = Enabled].

1. Check U5-21 [Energy Save Coeff Ki] and make sure that it aligns with the Ki value on the motor nameplate.
2. If the numbers are different, set $b8-16$ to the Ki value on the motor nameplate.

■ b8-17: PM E-Save Coefficient Kt

No. (Hex.)	Name	Description	Default (Range)
b8-17 (01F9) Expert	PM E-Save Coefficient Kt	<div style="display: flex; justify-content: space-between; font-size: 0.8em; margin-bottom: 5px;"> V/f CL-V/f OLV CLV AOLV OLV/PM AOLV/PM CLV/PM EZOLV </div> Sets torque linearity. This parameter uses the Kt value from the motor nameplate. Usually it is not necessary to change this setting.	1.00 (0.00 - 3.00)

When $E5-01 = 1xxx, 2xxx$ [PM Motor Code Selection = Yaskawa SSR1 or SST4 series IPM motor], the drive automatically calculates the energy-saving coefficient Kt and uses that value to control operation.

Do this procedure to prevent oscillation when you set $b8-01 = 1$ [Energy Saving Control Selection = Enabled].

1. Check U5-22 [Energy Save Coeff Kt] and make sure that it aligns with the Kt value on the motor nameplate.
2. If the numbers are different, set $b8-17$ to the Kt value on the motor nameplate.

■ b8-18: E-Save d-axis Current FilterTime

No. (Hex.)	Name	Description	Default (Range)
b8-18 (01FA) Expert	E-Save d-axis Current FilterTime	<div style="display: flex; justify-content: space-between; font-size: 0.8em; margin-bottom: 5px;"> V/f CL-V/f OLV CLV AOLV OLV/PM AOLV/PM CLV/PM EZOLV </div> Sets the d-axis current reference filter time constant.	0.100 s (0.000 - 5.000 s)

■ b8-19: E-Save Search Frequency

No. (Hex.)	Name	Description	Default (Range)
b8-19 (0B40) Expert	E-Save Search Frequency	<div style="display: flex; justify-content: space-between; font-size: 0.8em; margin-bottom: 5px;"> V/f CL-V/f OLV CLV AOLV OLV/PM AOLV/PM CLV/PM EZOLV </div> Sets the frequency of Energy-saving control search operations. Usually it is not necessary to change this setting.	Determined by A1-02 (10 - 300 Hz)

Note:

- If low inertia causes vibration in the machine, increase the setting value in 10 Hz increments and check the response. If $A1-02 = 8$ [Control Method Selection = EZOLV], increase the setting value in 1 Hz increments.
- To make the motor more efficient, decrease the setting value in 1 Hz increments until the point immediately before machine vibration starts to occur.

■ b8-20: E-Save Search Width

No. (Hex.)	Name	Description	Default (Range)
b8-20 (0B41) Expert	E-Save Search Width	<div style="display: flex; justify-content: space-between; font-size: 0.8em; margin-bottom: 5px;"> V/f CL-V/f OLV CLV AOLV OLV/PM AOLV/PM CLV/PM EZOLV </div> Sets the amplitude of Energy-saving control search operations.	1.0 degrees (0.1 - 5.0 degrees)

An increase in the value can make the operational efficiency better. However, if the load inertia is small, it may be necessary to adjust the value to prevent machine vibration.

Note:

- If low inertia causes vibration in the machine, decrease the setting value in 1.0-degree increments and check the response.
- To make the motor more efficient, increase the setting value in 1.0-degree increments until the point immediately before machine vibration starts to occur.

■ b8-21: PM E-Save Search Gain

No. (Hex.)	Name	Description	Default (Range)
b8-21 (0B42) Expert	PM E-Save Search Gain	<div style="display: flex; justify-content: space-between; font-size: 0.8em; margin-bottom: 5px;"> V/f CL-V/f OLV CLV AOLV OLV/PM AOLV/PM CLV/PM EZOLV </div> Sets the gain of Energy-saving control search operations.	0.3Hz (0.1 - 20.0 Hz)

When you decrease the value of *C5-01 [ASR Proportional Gain 1]*, also decrease the value of *b8-21* to keep the correct ratio.

■ b8-22: PM E-Save Search LPF Cutoff Freq

No. (Hex.)	Name	Description	Default (Range)
b8-22 (0B43) Expert	PM E-Save Search LPF Cutoff Freq	<div style="display: flex; justify-content: space-between; font-size: 0.8em; margin-bottom: 5px;"> V/f CL-V/f OLV CLV AOLV OLV/PM AOLV/PM CLV/PM EZOLV </div> Sets the frequency of the filter used to extract the high-efficiency phase from search operations. Usually it is not necessary to change this setting.	10.0 Hz (1.0 - 30.0 Hz)

■ b8-23: PM E-Save Search Limit

No. (Hex.)	Name	Description	Default (Range)
b8-23 (0B44) Expert	PM E-Save Search Limit	<div style="display: flex; justify-content: space-between; font-size: 0.8em; margin-bottom: 5px;"> V/f CL-V/f OLV CLV AOLV OLV/PM AOLV/PM CLV/PM EZOLV </div> Sets the search operations output limit. Usually it is not necessary to change this setting.	15.0 degrees (0.0 - 30.0 degrees)

When the motor characteristics are correct, increase this value to make the motor more efficient.

■ b8-24: PM E-Save High Freq ACR Gain

No. (Hex.)	Name	Description	Default (Range)
b8-24 (0B45) Expert	PM E-Save High Freq ACR Gain	<div style="display: flex; justify-content: space-between; font-size: 0.8em; margin-bottom: 5px;"> V/f CL-V/f OLV CLV AOLV OLV/PM AOLV/PM CLV/PM EZOLV </div> Sets the gain for high-frequency current control.	200.0 Hz (100.0 - 1000.0 Hz)

Note:

If the drive detects *oC [Overcurrent]*, decrease the value.

■ b8-25: PM E-Save Search Start Level

No. (Hex.)	Name	Description	Default (Range)
b8-25 (0B46) Expert	PM E-Save Search Start Level	<div style="display: flex; justify-content: space-between; font-size: 0.8em; margin-bottom: 5px;"> V/f CL-V/f OLV CLV AOLV OLV/PM AOLV/PM CLV/PM EZOLV </div> Sets the start level for search operations.	10.0% (0.0 - 100.0%)

12.3 b: Application

Note:

If there is vibration in the machine, increase the value.

■ b8-26: PM E-Save Power Setpoint

No. (Hex.)	Name	Description	Default (Range)
b8-26 (0B47) Expert	PM E-Save Power Setpoint	V/f CL-V/f OLV CLV AOLV OLV/PM AOLV/PM CLV/PM EZOLV Sets a value to increase torque accuracy.	0.0% (-10.0 - +10.0%)

■ b8-28: Over Excitation Action Selection

No. (Hex.)	Name	Description	Default (Range)
b8-28 (0B8B) Expert	Over Excitation Action Selection	V/f CL-V/f OLV CLV AOLV OLV/PM AOLV/PM CLV/PM EZOLV Sets the function for excitation operation.	0 (0, 1)

When operation is not stable at low speeds, set this parameter to 1 to enable the function.

0 : Disabled

1 : Enabled

■ b8-29: Energy Saving Priority Selection

No. (Hex.)	Name	Description	Default (Range)
b8-29 (0B8C)	Energy Saving Priority Selection	V/f CL-V/f OLV CLV AOLV OLV/PM AOLV/PM CLV/PM EZOLV Sets the priority of drive response between changes to the load or Energy-saving control. Enable this to prioritize energy-saving control. Disable this to prioritize tracking related to fast load changes, and prevent motor stall.	0 (0, 1)

Enable this parameter when there are small changes in the load. It is possible that the motor cannot respond correctly to changes in the load.

0 : Priority: Drive Response

1 : Priority: Energy Savings

■ b8-50: Standby Mode Selection

No. (Hex.)	Name	Description	Default (Range)
b8-50 (0B0D)	Standby Mode Selection	V/f CL-V/f OLV CLV AOLV OLV/PM AOLV/PM CLV/PM EZOLV Sets the Standby Mode function.	0 (0, 1)

0 : Disabled

1 : Enabled

Standby Mode decreases how much power the drive consumes when it is in standby.

Standby Mode waits for the drive to stop, uses the relay output of an MFDO terminal to shut off the input side electromagnetic contactor (MC), then shuts off the main circuit power supply.

Note:

These conditions are also necessary for Standby Mode:

- Connect an external 24 V power supply.
- Connect an electromagnetic contactor to the drive input side and connect the MFDO terminal set for $H2-xx = 65$ [Standby Output]. When the MFDO terminal is OFF, the electromagnetic contactor must be OFF.
- Frequently starting and stopping the drive and regularly opening and closing the electromagnetic contactor will decrease the service life of the drive.

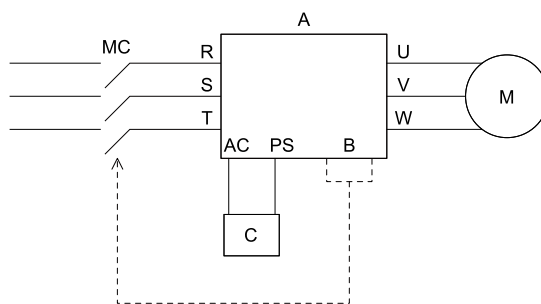

A - Drive
B - MFDO Terminal

C - External 24 V power supply

■ b8-51: Standby Mode Wait Time

No. (Hex.)	Name	Description	Default (Range)
b8-51 (0B01)	Standby Mode Wait Time	V/f CL-V/f OLV CLV AOLV OLV/PM AOLV/PM CLV/PM EZOLV	600 s (0 - 6000 s)

◆ b9: Zero Servo

Zero Servo is a position control function that stops and holds the motor shaft. The drive safeties the stopped motor and an external force will not move the motor.

When you enable the Zero Servo function, the drive will save the home position. The drive can correct the motor position and put the motor into the home position when the load rotates the motor.

To enable Zero Servo, set $H1-xx = 72$ [MFDI Function Selection = Zero Servo]. The drive starts Zero Servo when the MFDI terminal set for Zero Servo [$H1-xx = 72$] activates and the motor speed decreases to less than the value set in $b2-01$ [DC Injection/Zero SpeedThreshold]. The drive stops and holds the motor in the Zero Servo start position.

When Zero Servo is enabled, the drive will hold the motor in position when the frequency reference increases to more than the value set in $b2-01$. When Zero Servo is enabled, the drive will hold the motor in position when the frequency reference increases to more than the value set in $b2-01$.

Note:

Zero Servo is available when $A1-02 = 3, 7$ [Control Method Selection = Closed Loop Vector; PM Closed Loop Vector].

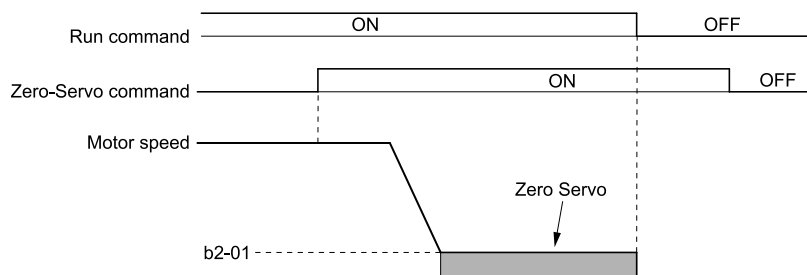

Figure 12.43 Zero Servo Time Chart

Monitor $U6-22$ [ZeroServoPulse Move] shows the difference between the position of the motor shaft and the Zero Servo start position when Zero Servo is enabled. To find the difference, divide the number of pulses shown in $U6-22$ by 4.

When the position of the motor shaft is in the range of "Zero Servo start position $\pm b9-02$ [Zero Servo Completion Window]", the drive will activate an MFDO set for Zero Servo Complete [$H2-xx = 33$].

NOTICE: Do not let the Zero Servo function hold 100% load for long periods of time. When the application must use Zero Servo to hold 100% load for long periods, operate in less than 50% of the drive rated output current or use a larger capacity drive. If Zero Servo holds the load for too long in 50% or more of the drive rated output current, it will cause damage to the drive.

Note:

- When you use the Zero Servo function, keep the Run command ON. If the Run command is OFF, the drive will not hold the motor shaft in position.
- When you turn oFF the Zero-Servo command, the terminal set for Zero Servo Complete will deactivate.
- If $A1-02 = 7$ [*PM Closed Loop Vector*] and an external force rotates the motor during Zero Servo, the drive will detect $dv4$ [*Inversion Prevention Detection*]. To prevent $dv4$ detection, increase $b9-01$ [*Zero Servo Gain*] or increase the number of pulses set in $F1-19$ [*Deviation 4 Detection Selection*].

■ b9-01: Zero Servo Gain

No. (Hex.)	Name	Description	Default (Range)
b9-01 (01DA)	Zero Servo Gain	<div style="display: flex; justify-content: space-between; align-items: center;"> V/f CL-V/f OLV CLV AOLV OLV/PM AOLV/PM CLV/PM EZOLV </div> <p>Sets the responsiveness for the Zero Servo function.</p>	5 (0 - 100)

If the drive is not responsive, or if there is too much deviation from the Zero Servo start point when you increase the load, increase this setting. If oscillation or hunting occurs, decrease this setting.

Note:

- Set $C5-xx$ [*Automatic Speed Regulator (ASR)*] parameters correctly before you adjust the Zero Servo gain.
- When you operate with the Zero Servo command enabled, oscillation and hunting must not occur.

■ b9-02: Zero Servo Completion Window

No. (Hex.)	Name	Description	Default (Range)
b9-02 (01DB)	Zero Servo Completion Window	<div style="display: flex; justify-content: space-between; align-items: center;"> V/f CL-V/f OLV CLV AOLV OLV/PM AOLV/PM CLV/PM EZOLV </div> <p>Sets the range to trigger an output terminal set for "Zero Servo Complete" during Zero Servo operation. Be sure to set the deviation from the Zero Servo start position.</p>	10 (0 - 16383)

When the position of the motor shaft is in the range of "Zero Servo start position $\pm b9-02$ ", the drive will activate a MFDO set for *Zero Servo Complete* [$H2-xx = 33$].

12.4 C: Tuning

C parameters adjust drive operation, including:

- Acceleration Time
- Deceleration Time
- Slip Compensation
- Torque Compensation
- Carrier Frequency

◆ C1: Accel & Decel Time

You can set four different acceleration and deceleration time pairs in the drive. When you activate and deactivate H1-xx = 7, 16, 1A [MFDI Function Select = Accel/Decel Time Selection 1, Motor 2 Selection, Accel/Decel Time Selection 2], you can switch acceleration and deceleration times during run.

Acceleration time parameters always set the time to accelerate from 0 Hz to *E1-04* [Maximum Output Frequency]. Deceleration time parameters always set the time to decelerate from *E1-04* to 0 Hz.

C1-01 [Acceleration Time 1] and *C1-02* [Deceleration Time 1] are the default active accel/decel settings.

Parameter	Range
C1-01 [Acceleration Time 1]	0.0 to 6000.0 s
C1-02 [Deceleration Time 1]	
C1-03 [Acceleration Time 2]	
C1-04 [Deceleration Time 2]	
C1-05 [Acceleration Time 3]	
C1-06 [Deceleration Time 3]	
C1-07 [Acceleration Time 4]	
C1-08 [Deceleration Time 4]	

Note:

The setting range for acceleration and deceleration times is 0.00 to 600.00 s when *C1-10* = 0 [Accel/Decel Time Setting Units = 0.01 s (0.00 to 600.00 s)].

■ Use MFDIs to Switch Acceleration Times

Table 12.29 shows the different acceleration and deceleration times.

Table 12.29 Accel/Decel Times and Active Parameters

H1-xx = 7 [Accel/Decel Time Selection 1]	H1-xx = 1A [Accel/Decel Time Selection 2]	Active Parameter	
		Acceleration Time	Deceleration Time
OFF	OFF	C1-01 [Acceleration Time 1]	C1-02 [Deceleration Time 1]
ON	OFF	C1-03 [Acceleration Time 2]	C1-04 [Deceleration Time 2]
OFF	ON	C1-05 [Acceleration Time 3]	C1-06 [Deceleration Time 3]
ON	ON	C1-07 [Acceleration Time 4]	C1-08 [Deceleration Time 4]

Figure 12.44 shows an operation example to change acceleration and deceleration times. It is necessary to set *b1-03* = 0 [Stopping Method Selection = Ramp to Stop] for this example.

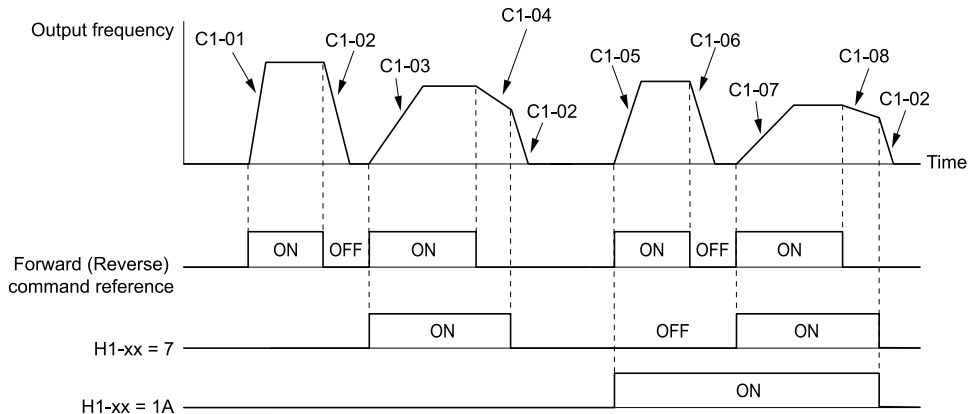

Figure 12.44 Timing Diagram of Acceleration and Deceleration Times

■ Use Motor Selection to Switch Acceleration and Deceleration Times

When you set $H1-xx = 16$ [MFDI Function Selection = Motor 2 Selection], you can activate and deactivate the input terminal to switch between motor 1 and motor 2.

Note:

You cannot use the Motor 2 Selection function with PM motors.

Table 12.30 shows the possible acceleration and deceleration time combinations when you use the Motor 2 Selection function.

Table 12.30 Motor Selection and Acceleration and Deceleration Times

H1-xx = 7 [Accel/Decel Time Selection 1]	H1-xx = 16 [Motor 2 Selection]			
	Motor 2 Selection: OFF		Motor 2 Selection: ON	
	Acceleration Time	Deceleration Time	Acceleration Time	Deceleration Time
OFF	C1-01	C1-02	C1-05	C1-06
ON	C1-03	C1-04	C1-07	C1-08

■ Use Output Frequency Level to Switch Acceleration and Deceleration Times

The drive can use output frequency to automatically switch between different acceleration and deceleration times. When the output frequency = $C1-11$ [Accel/Decel Time Switchover Freq], the drive automatically switches the acceleration and deceleration times. Set $C1-11 = 0.0$ Hz to disable this function.

Note:

- Acceleration and deceleration times set to MFDIs are more important than the automatic switch using the frequency level set in $C1-11$. For example, if you set the switchover frequency to $C1-11$, the drive will not automatically switch acceleration and deceleration times when the MFDI terminal set for *Accel/Decel Time Selection 1* [$H1-xx = 7$] is activated.
- If Motor 2 Selection [$H1-xx = 16$] is activated, the drive will set the acceleration/deceleration time to $C1-05$ and $C1-06$ for motor 2 when the output frequency is more than the frequency level set in $C1-11$.

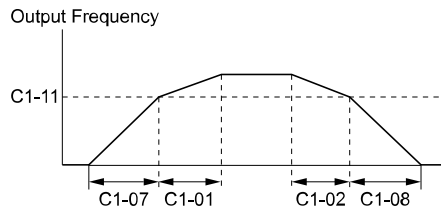

When the output frequency $\geq C1-11$, drive uses Accel/Decel Time 1 (C1-01, -02)
 When the output frequency $< C1-11$, drive uses Accel/Decel Time 2 (C1-07, -08)

Figure 12.45 Accel/Decel Time Switching Frequency

■ C1-01: Acceleration Time 1

No. (Hex.)	Name	Description	Default (Range)
C1-01 (0200) RUN	Acceleration Time 1	<div style="display: flex; justify-content: space-between; font-size: 0.8em; font-weight: bold;"> V/f CL-V/f OLV CLV AOLV OLV/PM AOLV/PM CLV/PM EZOLV </div> Sets the length of time to accelerate from zero to maximum output frequency.	10.0 s (0.0 - 6000.0 s)

Note:

When $C1-10 = 0$ [Accel/Decel Time Setting Units = 0.01 s (0.00 to 600.00 s)], the setting range is 0.00 to 600.00 s.

■ C1-02: Deceleration Time 1

No. (Hex.)	Name	Description	Default (Range)
C1-02 (0201) RUN	Deceleration Time 1	<div style="display: flex; justify-content: space-between; font-size: 0.8em; font-weight: bold;"> V/f CL-V/f OLV CLV AOLV OLV/PM AOLV/PM CLV/PM EZOLV </div> Sets the length of time to decelerate from maximum output frequency to zero.	10.0 s (0.0 - 6000.0 s)

Note:

When $C1-10 = 0$ [Accel/Decel Time Setting Units = 0.01 s (0.00 to 600.00 s)], the setting range is 0.00 to 600.00 s.

■ C1-03: Acceleration Time 2

No. (Hex.)	Name	Description	Default (Range)
C1-03 (0202) RUN	Acceleration Time 2	<div style="display: flex; justify-content: space-between; font-size: 0.8em; font-weight: bold;"> V/f CL-V/f OLV CLV AOLV OLV/PM AOLV/PM CLV/PM EZOLV </div> Sets the length of time to accelerate from zero to maximum output frequency.	10.0 s (0.0 - 6000.0 s)

Note:

When $C1-10 = 0$ [Accel/Decel Time Setting Units = 0.01 s (0.00 to 600.00 s)], the setting range is 0.00 to 600.00 s.

■ C1-04: Deceleration Time 2

No. (Hex.)	Name	Description	Default (Range)
C1-04 (0203) RUN	Deceleration Time 2	<div style="display: flex; justify-content: space-between; font-size: 0.8em; font-weight: bold;"> V/f CL-V/f OLV CLV AOLV OLV/PM AOLV/PM CLV/PM EZOLV </div> Sets the length of time to decelerate from maximum output frequency to zero.	10.0 s (0.0 - 6000.0 s)

Note:

When $C1-10 = 0$ [Accel/Decel Time Setting Units = 0.01 s (0.00 to 600.00 s)], the setting range is 0.00 to 600.00 s.

■ C1-05: Acceleration Time 3

No. (Hex.)	Name	Description	Default (Range)
C1-05 (0204) RUN	Acceleration Time 3	<div style="display: flex; justify-content: space-between; font-size: 0.8em; font-weight: bold;"> V/f CL-V/f OLV CLV AOLV OLV/PM AOLV/PM CLV/PM EZOLV </div> Sets the length of time to accelerate from zero to maximum output frequency.	10.0 s (0.0 - 6000.0 s)

Note:

When $C1-10 = 0$ [Accel/Decel Time Setting Units = 0.01 s (0.00 to 600.00 s)], the setting range is 0.00 to 600.00 s.

■ C1-06: Deceleration Time 3

No. (Hex.)	Name	Description	Default (Range)
C1-06 (0205) RUN	Deceleration Time 3	<div style="display: flex; justify-content: space-between; font-size: 0.8em; font-weight: bold;"> V/f CL-V/f OLV CLV AOLV OLV/PM AOLV/PM CLV/PM EZOLV </div> Sets the length of time to decelerate from maximum output frequency to zero.	10.0 s (0.0 - 6000.0 s)

Note:

When $C1-10 = 0$ [Accel/Decel Time Setting Units = 0.01 s (0.00 to 600.00 s)], the setting range is 0.00 to 600.00 s.

■ **C1-07: Acceleration Time 4**

No. (Hex.)	Name	Description	Default (Range)
C1-07 (0206) RUN	Acceleration Time 4	<div style="display: flex; justify-content: space-between; font-size: 0.8em; font-weight: bold;"> V/f CL-V/f OLV CLV AOLV OLV/PM AOLV/PM CLV/PM EZOLV </div> <p>Sets the length of time to accelerate from zero to maximum output frequency.</p>	10.0 s (0.0 - 6000.0 s)

Note:

When $C1-10 = 0$ [Accel/Decel Time Setting Units = 0.01 s (0.00 to 600.00 s)], the setting range is 0.00 to 600.00 s.

■ **C1-08: Deceleration Time 4**

No. (Hex.)	Name	Description	Default (Range)
C1-08 (0207) RUN	Deceleration Time 4	<div style="display: flex; justify-content: space-between; font-size: 0.8em; font-weight: bold;"> V/f CL-V/f OLV CLV AOLV OLV/PM AOLV/PM CLV/PM EZOLV </div> <p>Sets the length of time to decelerate from maximum output frequency to zero.</p>	10.0 s (0.0 - 6000.0 s)

Note:

When $C1-10 = 0$ [Accel/Decel Time Setting Units = 0.01 s (0.00 to 600.00 s)], the setting range is 0.00 to 600.00 s.

■ **C1-09: Fast Stop Time**

No. (Hex.)	Name	Description	Default (Range)
C1-09 (0208) RUN	Fast Stop Time	<div style="display: flex; justify-content: space-between; font-size: 0.8em; font-weight: bold;"> V/f CL-V/f OLV CLV AOLV OLV/PM AOLV/PM CLV/PM EZOLV </div> <p>Sets the length of time that the drive will decelerate to zero for a Fast Stop.</p>	10.0 s (0.0 - 6000.0 s)

Note:

- When $C1-10 = 0$ [Accel/Decel Time Setting Units = 0.01 s (0.00 to 600.00 s)], the setting range is 0.00 to 600.00 s.
- When $L2-29 = 0$ [Kinetic Energy Backup Method = Single Drive KEB Ride-Thru 1] and you do KEB Auto-Tuning, the drive will automatically set $C1-09$. If you must not change the Fast Stop time, do not do KEB Auto-Tuning.

The Fast Stop function will be triggered in the following circumstances.

- The Fast Stop operation will be triggered by the input of the Fast Stop command via the multi-function digital input terminal.
- The Fast Stop operation is will be triggered when by the input of the Fast Stop command is input via the multi-function digital input terminal.

Set $H1-xx = 15, 17$ [MFDI Function Select = Fast Stop (N.O.), Fast Stop (N.C.)].

When the Fast Stop command is input, the Fast Stop operation will be triggered at the deceleration time set to $C1-09$. The drive cannot be restarted after initiating a Fast Stop operation until deceleration is complete. Complete deceleration and cycle the Run command to clear the Fast Stop input.

The terminal set for $H2-xx = 4C$ [MFDO Function Select = During Fast Stop] will be ON during Fast Stop.

Note:

Decelerating too quickly can cause an *ov* [Overvoltage] fault that shuts off the drive while the motor to coasts to a stop. Set a Fast Stop time in $C1-09$ that prevents motor coasting and makes sure that the motor stops quickly and safely.

■ **C1-10: Accel/Decel Time Setting Units**

No. (Hex.)	Name	Description	Default (Range)
C1-10 (0209)	Accel/Decel Time Setting Units	<div style="display: flex; justify-content: space-between; font-size: 0.8em; font-weight: bold;"> V/f CL-V/f OLV CLV AOLV OLV/PM AOLV/PM CLV/PM EZOLV </div> <p>Sets the setting units for $C1-01$ to $C1-08$ [Accel/Decel Times 1 to 4], $C1-09$ [Fast Stop Time], $L2-06$ [Kinetic Energy Backup Decel Time], and $L2-07$ [Kinetic Energy Backup Accel Time].</p>	1 (0, 1)

0 : 0.01 s (0.00 to 600.00 s)

Sets acceleration and deceleration times in 0.01 s units. The setting range is 0.0 to 6000.0 s.

If one of these parameters is set to 1000.0 s or longer, you cannot set $C1-10 = 0$:

- $C1-01$ to $C1-09$

- L2-06
- L2-07

When one of those parameters is set to a value between 600.1 s and 1000.0 s, you can set $C1-10 = 0$, but the time will change to 600.00 s.

1 : 0.1 s (0.0 to 6000.0 s)

Sets acceleration and deceleration times in 0.1 s units. The setting range is 0.0 to 6000.0 s.

■ C1-11: Accel/Decel Time Switchover Freq

No. (Hex.)	Name	Description	Default (Range)
C1-11 (020A)	Accel/Decel Time Switching Frequency	V/f CL-V/f OLV CLV AOLV OLV/PM AOLV/PM CLV/PM EZOLV Sets the frequency at which the drive will automatically change acceleration and deceleration times.	Determined by A1-02 (0.0 - 590.0 Hz)

When output frequency get $C1-11$ value, the drive automatically switches the acceleration and deceleration times. Set this parameter to 0.0 to disable this function.

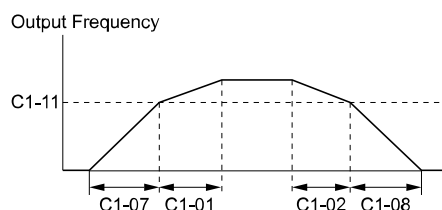

When the output frequency $\geq C1-11$, drive uses Accel/Decel Time 1 (C1-01, -02)
When the output frequency $< C1-11$, drive uses Accel/Decel Time 2 (C1-07, -08)

Figure 12.46 Accel/Decel Time Switching Frequency

Table 12.31 lists the possible combinations of acceleration and deceleration time switchover frequencies and the acceleration times for the Motor 2 Selection function.

Table 12.31 Motor and Acceleration and Deceleration Time Combination

C1-11	Motor 1		Motor 2	
	Acceleration Time	Deceleration Time	Acceleration Time	Deceleration Time
Less than the setting value	C1-07 [Acceleration Time 4]	C1-08 [Deceleration Time 4]	C1-07 [Acceleration Time 4]	C1-08 [Deceleration Time 4]
Equal to or more than the setting value	C1-01 [Acceleration Time 1]	C1-02 [Deceleration Time 1]	C1-05 [Acceleration Time 3]	C1-06 [Deceleration Time 3]

■ C1-14: Accel/Decel Rate Frequency

No. (Hex.)	Name	Description	Default (Range)
C1-14 (0264) RUN	Accel/Decel Rate Frequency	V/f CL-V/f OLV CLV AOLV OLV/PM AOLV/PM CLV/PM EZOLV Sets the base frequency used to calculate acceleration and deceleration rates.	0.0 Hz (0.0 - 590.0 Hz)

The acceleration and deceleration rates set in $C1-01$ to $C1-09$ [Acceleration/Deceleration Times 1 to 4, Fast Stop Time] will change when the value of $C1-14$ changes.

- When $C1-14 = 0.0$ Hz
 - $C1-01$, $C1-03$, $C1-05$, $C1-07$ [Acceleration Times 1 to 4]: Time to accelerate from 0 Hz to $E1-04$ [Maximum Output Frequency]
 - $C1-02$, $C1-04$, $C1-06$, $C1-08$ [Deceleration Times 1 to 4], $C1-09$ [Fast Stop Time]: Time to decelerate from $E1-04$ to 0 Hz.

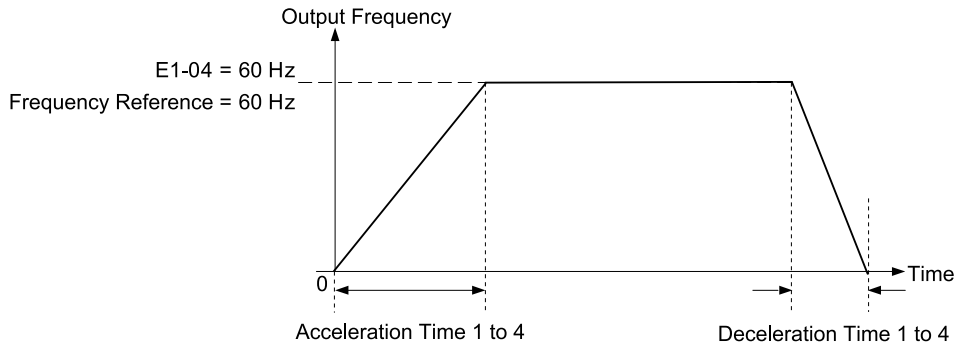

Figure 12.47 Example 1: Acceleration/Deceleration Rate (When C1-14 = 0 Hz, E1-04 = 60 Hz, and the Frequency Reference is 60 Hz)

- When $C1-14 \neq 0.0$ Hz
 - C1-01, C1-03, C1-05, C1-07: Time to accelerate from 0 Hz to C1-14
 - C1-02, C1-04, C1-06, C1-08, C1-09: Time to decelerate from C1-14 to 0 Hz

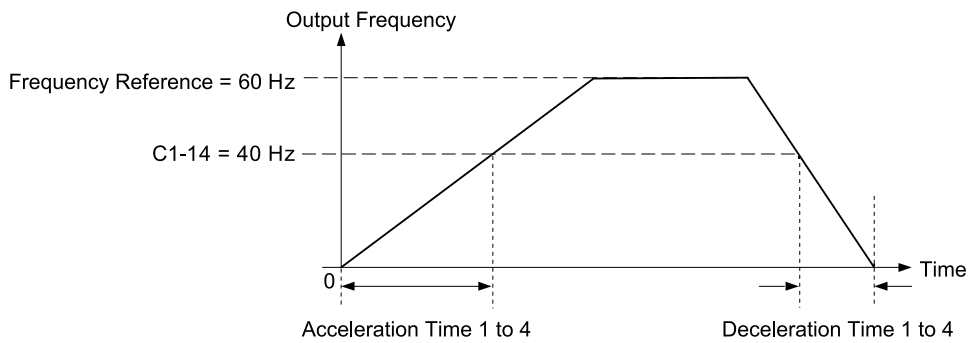

Figure 12.48 Example 2: Acceleration/Deceleration Rate (When C1-14 = 40 Hz, E1-04 = 60 Hz, and the Frequency Reference is 60 Hz)

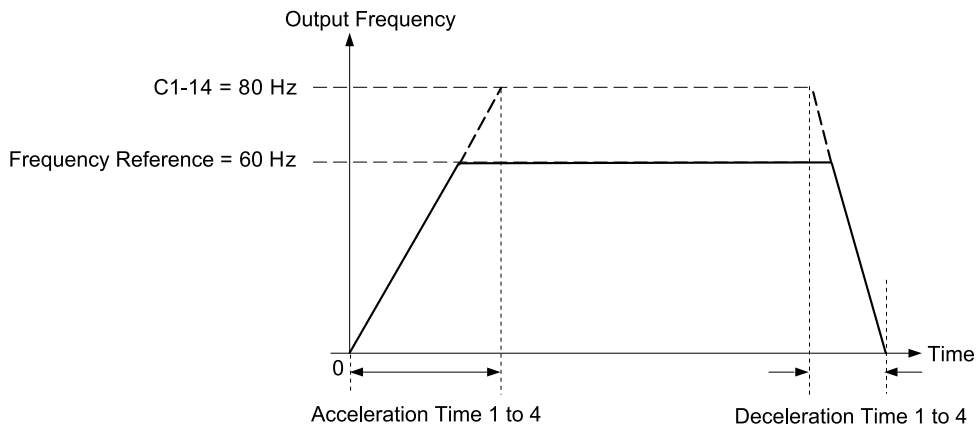

Figure 12.49 Example 3: Acceleration/Deceleration Rate (When C1-14 = 80 Hz, E1-04 = 60 Hz, and the Frequency Reference is 60 Hz)

Note:

- Figure 12.47 to Figure 12.49 show the accel/decel times when C2-01 to C2-04 [S-Curve Times @ Start/End of Accel/Decel] = 0.00 s.
- When L3-01 $\neq 0$ [Stall Prevention during Accel \neq Disabled], Stall Prevention could cause the acceleration time to be longer than the set value.
- When L3-04 $\neq 0$ [Stall Prevention during Decel \neq Disabled], Stall Prevention could cause the deceleration time to be longer than the set value.

◆ **C2: S-Curve Characteristics**

Use S-curve characteristics to smooth acceleration and deceleration and to minimize abrupt shock to the load.

Set S-curve characteristic time during acceleration/deceleration at start and acceleration/deceleration at stop. The following figure explains how S-curves are applied.

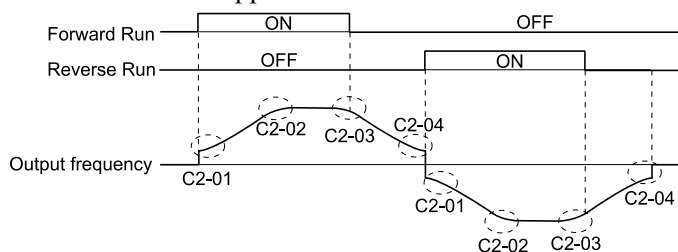

Figure 12.50 S-Curve Timing Diagram - Forward/Reverse Operation

Note:

- If STPo [Motor Step-Out Detected] occurs when starting a PM motor, try increasing the value set to C2-01.
- Setting the S-curve will increase the acceleration and deceleration times.

$$\text{Acceleration time} = \text{Selected acceleration time} + \frac{C2-01 + C2-02}{2}$$

$$\text{Deceleration time} = \text{Selected deceleration time} + \frac{C2-03 + C2-04}{2}$$

■ C2-01: S-Curve Time @ Start of Accel

No. (Hex.)	Name	Description	Default (Range)
C2-01 (020B)	S-Curve Time @ Start of Accel	V/f CL-V/f OLV CLV AOLV OLV/PM AOLV/PM CLV/PM EZOLV Sets the S-curve acceleration time at start.	Determined by A1-02 (0.00 - 10.00 s)

■ C2-02: S-Curve Time @ End of Accel

No. (Hex.)	Name	Description	Default (Range)
C2-02 (020C)	S-Curve Time @ End of Accel	V/f CL-V/f OLV CLV AOLV OLV/PM AOLV/PM CLV/PM EZOLV Sets the S-curve acceleration time at completion.	0.20 s (0.00 - 10.00 s)

■ C2-03: S-Curve Time @ Start of Decel

No. (Hex.)	Name	Description	Default (Range)
C2-03 (020D)	S-Curve Time @ Start of Decel	V/f CL-V/f OLV CLV AOLV OLV/PM AOLV/PM CLV/PM EZOLV Sets the S-curve deceleration time at start.	0.20 s (0.00 - 10.00 s)

■ C2-04: S-Curve Time @ End of Decel

No. (Hex.)	Name	Description	Default (Range)
C2-04 (020E)	S-Curve Time @ End of Decel	V/f CL-V/f OLV CLV AOLV OLV/PM AOLV/PM CLV/PM EZOLV Sets the S-curve deceleration time at completion.	0.00 s (0.00 - 10.00 s)

◆ C3: Slip Compensation

The Slip Compensation function improves the speed accuracy of an induction motor. As loads on induction motors increase, motor slip increases and motor speed decreases. By adjusting the output frequency in accordance with the motor load, it compensates the slip and makes the motor speed equal to the frequency reference.

■ C3-01: Slip Compensation Gain

No. (Hex.)	Name	Description	Default (Range)
C3-01 (020F) RUN	Slip Compensation Gain	<div style="display: flex; justify-content: space-between; font-size: 0.8em; margin-bottom: 5px;"> V/f CL-V/f OLV CLV AOLV OLV/PM AOLV/PM CLV/PM EZOLV </div> Sets the gain for the slip compensation function. Usually it is not necessary to change this setting.	Determined by A1-02 (0.0 - 2.5)

Note:

- Correctly set these parameters before changing the slip compensation gain:
 - E2-01 [Motor Rated Current (FLA)]
 - E2-02 [Motor Rated Slip]
 - E2-03 [Motor No-Load Current]
- When $A1-02 = 3$ [CLV], the slip compensation gain becomes the motor temperature compensation gain. When the motor temperature increases, the motor internal constant changes and increases the slip. When you set this parameter, the drive adjusts the slip with the increase in temperature. Adjust this parameter in these conditions: When the setting value increases, the compensation also increases:
 - The drive is doing torque control.
 - There are torque limits.
 - Output torque changes when the temperature changes.

Use these settings to adjust this parameter as necessary:

- If the motor speed is slower than the frequency reference, increase C3-01 in 0.1 unit increments.
- If the motor speed is higher than the frequency reference, decrease the setting of this parameter in 0.1-unit increments.

■ C3-02: Slip Compensation Delay Time

No. (Hex.)	Name	Description	Default (Range)
C3-02 (0210) RUN	Slip Compensation Delay Time	<div style="display: flex; justify-content: space-between; font-size: 0.8em; margin-bottom: 5px;"> V/f CL-V/f OLV CLV AOLV OLV/PM AOLV/PM CLV/PM EZOLV </div> Sets the slip compensation delay time when speed is unstable or when the slip compensation response is too slow. Usually it is not necessary to change this setting.	Determined by A1-02 (0 - 10000 ms)

Use these settings to adjust this parameter as necessary:

- When the speed is not stable, increase the setting.
- When the slip compensation response is too slow, decrease the setting.

■ C3-03: Slip Compensation Limit

No. (Hex.)	Name	Description	Default (Range)
C3-03 (0211)	Slip Compensation Limit	<div style="display: flex; justify-content: space-between; font-size: 0.8em; margin-bottom: 5px;"> V/f CL-V/f OLV CLV AOLV OLV/PM AOLV/PM CLV/PM EZOLV </div> Sets the upper limit for the slip compensation function as a percentage of the motor rated slip.	200% (0 - 250%)

If you increase the value of C3-01 [Slip Compensation Gain] and the motor speed is slow, use this parameter. The drive uses this parameter when the slip is at the upper limit of slip compensation. Make sure that you measure the motor speed when you increase this parameter value. Set this parameter to make the frequency reference and the slip compensation limit less than the permitted range of the machine.

The slip compensation limit is constant in the constant torque range (frequency reference \leq E1-06 [Base Frequency]). In the constant output range where the frequency reference $>$ E1-06, the slip compensation limit increases with the C3-03 value and the output frequency as shown in [Figure 12.51](#).

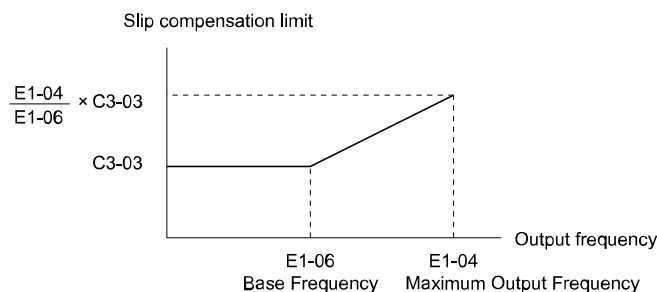

Figure 12.51 Slip Compensation Limit

■ C3-04: Slip Compensation at Regen

No. (Hex.)	Name	Description	Default (Range)
C3-04 (0212)	Slip Compensation at Regen	<input type="checkbox"/> V/f <input type="checkbox"/> CL-V/f <input checked="" type="checkbox"/> OLV <input type="checkbox"/> CLV <input type="checkbox"/> AOLV <input type="checkbox"/> OLV/PM <input type="checkbox"/> AOLV/PM <input type="checkbox"/> CLV/PM <input type="checkbox"/> EZOLV Sets the slip compensation function during regenerative operation.	0 (0 - 2)

If you apply a regenerative load when slip compensation function during regeneration is active, the quantity of regeneration can increase immediately. In this condition, it is necessary to use a dynamic braking option (braking resistor or braking resistor unit).

0 : Disabled

The drive does not provide slip compensation during regeneration.

The load and operation status (regenerative operation) can cause the motor speed to be higher or lower than the frequency reference.

1 : Enabled Above 6Hz

Slip compensation function is enabled during regeneration. Slip compensation is disabled at output frequencies of 6 Hz or less.

2 : Enabled Above C3-15

The drive uses *E2-02 [Motor Rated Slip]* to automatically calculate the frequency range where it will disable slip compensation function during regenerative operation.

Slip compensation is enabled at frequencies as low as 2 Hz.

■ C3-05: Output Voltage Limit Selection

No. (Hex.)	Name	Description	Default (Range)
C3-05 (0213)	Output Voltage Limit Selection	<input type="checkbox"/> V/f <input type="checkbox"/> CL-V/f <input checked="" type="checkbox"/> OLV <input type="checkbox"/> CLV <input type="checkbox"/> AOLV <input type="checkbox"/> OLV/PM <input type="checkbox"/> AOLV/PM <input type="checkbox"/> CLV/PM <input type="checkbox"/> EZOLV Sets the automatic reduction of motor magnetic flux when the output voltage is saturated.	0 (0, 1)

The drive will decrease flux and increase current to compensate torque when voltage is saturated. Make sure that the drive has sufficient output current capacity before you enable this parameter. When this parameter = 1 [Enabled], the output current will increase by 10% at a maximum (at rated load) before it is enabled.

Enable this parameter to increase speed precision when you move heavy loads at high speeds in these conditions:

- Power supply voltage is low
- Motor rated voltage is high

Do not enable this parameter in these conditions:

- Operating a motor in the middle speed range or low speed range
- Power supply voltage is a minimum of 10% more than the motor rated voltage

When you enable this parameter, if the power supply voltage is much less than the motor rated voltage, torque control will not be accurate.

0 : Disabled

1 : Enabled

■ C3-16: Vout Modulation Limit Start Lvl

No. (Hex.)	Name	Description	Default (Range)
C3-16 (0261) Expert	Vout Modulation Limit Start Lvl	<div style="display: flex; justify-content: space-between; font-size: 0.8em;"> V/f CL-V/f OLV CLV AOLV OLV/PM AOLV/PM CLV/PM EZOLV </div> Sets the modulation factor that starts the output voltage limit operation when $C3-05 = 1$ [Output Voltage Limit Selection = Enabled].	90.0% (70.0 - 90.0%)

■ C3-17: Vout Modulation Limit Max Level

No. (Hex.)	Name	Description	Default (Range)
C3-17 (0262) Expert	Vout Modulation Limit Max Level	<div style="display: flex; justify-content: space-between; font-size: 0.8em;"> V/f CL-V/f OLV CLV AOLV OLV/PM AOLV/PM CLV/PM EZOLV </div> Sets the modulation factor used with $C3-18$ [Output Voltage Limit Level] for the output voltage limit operation when $C3-05 = 1$ [Output Voltage Limit Selection = Enabled].	100.0% (85.0 - 100.0%)

■ C3-18: Output Voltage Limit Level

No. (Hex.)	Name	Description	Default (Range)
C3-18 (0263) Expert	Output Voltage Limit Level	<div style="display: flex; justify-content: space-between; font-size: 0.8em;"> V/f CL-V/f OLV CLV AOLV OLV/PM AOLV/PM CLV/PM EZOLV </div> Sets the maximum drop width of the voltage reference when $C3-05 = 1$ [Output Voltage Limit Selection = Enabled].	90.0% (50.0 - 100.0%)

■ C3-21: Motor 2 Slip Compensation Gain

No. (Hex.)	Name	Description	Default (Range)
C3-21 (033E) RUN	Motor 2 Slip Compensation Gain	<div style="display: flex; justify-content: space-between; font-size: 0.8em;"> V/f CL-V/f OLV CLV AOLV OLV/PM AOLV/PM CLV/PM EZOLV </div> Sets the gain for the motor 2 slip compensation function. Usually it is not necessary to change this setting.	Determined by E3-01 (0.0 - 2.5)

Note:

Correctly set these parameters before changing the slip compensation gain:

- E4-01 [Motor 2 Rated Current]
- E4-02 [Motor 2 Rated Slip]
- E4-03 [Motor 2 Rated No-Load Current]

Use these settings to adjust this parameter as necessary:

- If the motor speed is slower than the frequency reference, increase C3-01 in 0.1 unit increments.
- If the motor speed is higher than the frequency reference, decrease the setting of this parameter in 0.1-unit increments.

■ C3-22: Motor 2 Slip Comp Delay Time

No. (Hex.)	Name	Description	Default (Range)
C3-22 (0241) RUN	Motor 2 Slip Comp Delay Time	<div style="display: flex; justify-content: space-between; font-size: 0.8em;"> V/f CL-V/f OLV CLV AOLV OLV/PM AOLV/PM CLV/PM EZOLV </div> Sets the slip compensation delay time for motor 2 when speed is unstable or when the slip compensation response is too slow. Usually it is not necessary to change this setting.	Determined by E3-01 (0 - 10000 ms)

Use these settings to adjust this parameter as necessary:

- When the speed is not stable, increase the setting.
- When the slip compensation response is too slow, decrease the setting.

■ C3-23: Motor 2 Slip Compensation Limit

No. (Hex.)	Name	Description	Default (Range)
C3-23 (0242)	Motor 2 Slip Compensation Limit	<div style="display: flex; justify-content: space-between; font-size: 0.8em;"> V/f CL-V/f OLV CLV AOLV OLV/PM AOLV/PM CLV/PM EZOLV </div> Sets the upper limit for the slip compensation function as a percentage of the motor 2 rated slip.	200% (0 - 250%)

If you increase the value of *C3-21 [Motor 2 Slip Compensation Gain]* and the motor speed is slow, use this parameter. The drive uses this parameter when the slip is at the upper limit of slip compensation. Make sure that you measure the motor speed when you increase this parameter value. Set this parameter to make the frequency reference and the slip compensation limit less than the permitted range of the machine.

The slip compensation limit is constant in the constant torque range (frequency reference $\leq E3-06$ [*Motor 2 Base Frequency*]). In the constant power range where the frequency reference $> E3-06$, the slip compensation limit increases with the *C3-23* value and the output frequency as shown in [Figure 12.52](#).

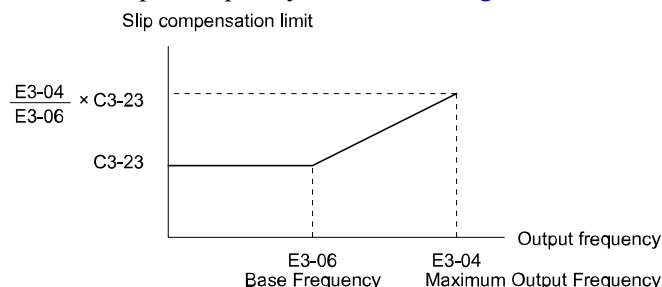

Figure 12.52 Motor 2 Slip Compensation Limit

■ C3-24: Motor 2 Slip Comp during Regen

No. (Hex.)	Name	Description	Default (Range)
C3-24 (0243)	Motor 2 Slip Comp during Regen	<input type="checkbox"/> V/f <input type="checkbox"/> CL-V/f <input type="checkbox"/> OLV <input checked="" type="checkbox"/> CLV <input type="checkbox"/> AOLV <input type="checkbox"/> OLV/PM <input type="checkbox"/> AOLV/PM <input type="checkbox"/> CLV/PM <input type="checkbox"/> EZOLV Sets the slip compensation during regenerative operation function for motor 2.	0 (0 - 2)

If you enable the slip compensation function during regeneration, the quantity of regeneration can increase immediately. In this condition, it is necessary to use a dynamic braking option (braking resistor or braking resistor unit).

0 : Disabled

The drive will not do Slip compensation during regeneration.

The load and operation status (regenerative operation) can cause the motor speed to be higher or lower than the frequency reference.

1 : Enabled Above 6Hz

The slip compensation function is enabled during regeneration. Slip compensation is disabled at output frequencies of 6 Hz or less.

2 : Enabled Above C3-15

The drive uses *E2-02 [Motor Rated Slip]* to automatically calculate the frequency range where it will disable slip compensation function during regeneration.

Slip compensation is enabled at frequencies as low as 2 Hz.

■ C3-28: Adaptive Slip Control Mode

No. (Hex.)	Name	Description	Default (Range)
C3-28 (1B5B) Expert	Adaptive Slip Control Mode	<input type="checkbox"/> V/f <input type="checkbox"/> CL-V/f <input type="checkbox"/> OLV <input checked="" type="checkbox"/> CLV <input type="checkbox"/> AOLV <input type="checkbox"/> OLV/PM <input type="checkbox"/> AOLV/PM <input type="checkbox"/> CLV/PM <input type="checkbox"/> EZOLV Sets the slip compensation function mode.	0 (0, 1)

0 : Normal

1 : Advanced

Note:

Set $C3-28 = 0$ for better torque precision. If the torque precision does not get better, set $C3-28 = 1$ and increase the value of *n4-65 [Flux Estimate Response@High Freq]* or *n4-66 [Flux Estimate Response @Low Freq]* in 0.1-unit increments. Then, you must do Rotational Auto-Tuning.

◆ C4: Torque Compensation

Torque compensation is a function that increases voltage to increase output torque as compensation for insufficient torque production at start-up or low-speed operation.

Voltage drops due to motor winding resistance cause torque generating voltage to decrease, which causes insufficient torque. If the main circuit cable connecting the drive and motor is long, this can also cause insufficient torque due to voltage drops.

Note:

Set the motor parameters and V/f pattern properly before setting *C4 parameters*.

■ C4-01: Torque Compensation Gain

No. (Hex.)	Name	Description	Default (Range)
C4-01 (0215) RUN	Torque Compensation Gain	<div style="display: flex; justify-content: space-between; font-size: 0.8em;"> V/f CL-V/f OLV CLV AOLV OLV/PM AOLV/PM CLV/PM EZOLV </div> <p>Sets the gain for the torque compensation function. Use this parameter value for motor 1 when operating multiple motors.</p>	Determined by A1-02 (0.00 - 2.50)

Adjust the setting in these control methods and conditions:

A1-02 [Control Method Selection]	Status	Adjustment
0 [V/f Control]	Torque is not sufficient during low-speed operation of 10 Hz or less.	Increase the setting in 0.05-unit increments.
1 [V/f Control with Encoder]	There is vibration in the motor when operating the drive with a light load.	Decrease the setting in 0.05-unit decrements.
8 [EZ Vector Control]	The cable between the drive and motor is too long.	Increase the setting in 0.05-unit increments.

Note:

- Adjust *C4-01* to make sure that the output current is not more than the drive rated current during low-speed operation.
- When *A1-02 = 2 [Open Loop Vector]*, usually it is not necessary to change this setting. If you change this parameter in that control method, it can decrease the torque precision.
- When *A1-02 = 5 [PM Open Loop Vector]*, usually it is not necessary to change this setting. Setting this value too high can cause overcompensation and motor oscillation.
- When *A1-02 = 8 [EZ Vector Control]*, you cannot change the setting while the drive is running.

■ C4-02: Torque Compensation Delay Time

No. (Hex.)	Name	Description	Default (Range)
C4-02 (0216) RUN	Torque Compensation Delay Time	<div style="display: flex; justify-content: space-between; font-size: 0.8em;"> V/f CL-V/f OLV CLV AOLV OLV/PM AOLV/PM CLV/PM EZOLV </div> <p>Sets the torque compensation delay time. Usually it is not necessary to change this setting.</p>	Determined by A1-02 (0 - 60000 ms)

Note:

If *A1-02 = 8 [Control Method Selection = EZOLV]*, you cannot change the setting while the drive is running.

Set this parameter in these conditions:

- If there is vibration in the motor, increase the setting.
- If the motor speed or motor torque response is too slow, decrease the setting.

■ C4-03: Torque Compensation @ FWD Start

No. (Hex.)	Name	Description	Default (Range)
C4-03 (0217)	Torque Compensation @ FWD Start	<div style="display: flex; justify-content: space-between; font-size: 0.8em;"> V/f CL-V/f OLV CLV AOLV OLV/PM AOLV/PM CLV/PM EZOLV </div> <p>Set the amount of torque reference for forward start as a percentage of the motor rated torque.</p>	0.0% (0.0 - 200.0%)

The torque compensation function is performed using the time constant set in *C4-05 [Torque Compensation Time]*.

This is available only when you start the motor with the forward command. Set this parameter to 0.0 to disable this function.

■ C4-04: Torque Compensation @ REV Start

No. (Hex.)	Name	Description	Default (Range)
C4-04 (0218)	Torque Compensation @ REV Start	V/f CL-V/f OLV CLV AOLV OLV/PM AOLV/PM CLV/PM EZOLV Sets the amount of torque reference for reverse start as a percentage of the motor rated torque.	0.0% (-200.0 - 0.0%)

The drive uses the time constant set in *C4-05 [Torque Compensation Time]* to do the torque compensation function. This is available only when you start the motor with the reverse Run command.

■ C4-05: Torque Compensation Time

No. (Hex.)	Name	Description	Default (Range)
C4-05 (0219)	Torque Compensation Time	V/f CL-V/f OLV CLV AOLV OLV/PM AOLV/PM CLV/PM EZOLV Sets the starting torque constant to use with <i>C4-03</i> and <i>C4-04 [Torque Compensation @ FWD/REV Start]</i> .	10 ms (0 - 200 ms)

■ C4-06: Motor 2 Torque Comp Delay Time

No. (Hex.)	Name	Description	Default (Range)
C4-06 (021A)	Motor 2 Torque Comp Delay Time	V/f CL-V/f OLV CLV AOLV OLV/PM AOLV/PM CLV/PM EZOLV Sets the value if <i>ov</i> [Overvoltage] occurs with sudden changes in the load, at the end of acceleration, or at the start of deceleration.	150 ms (0 - 10000 ms)

Sets the time constant used during Speed Search or during regenerative operation when *ov* occurs.

Adjust this parameter in the following circumstances.

- Gradually reduce the setting in 10 ms increments and check the performance to improve motor torque speed response when *ov* occurs.

Note:

- Ensure that $C4-06 \geq C4-02$ [Torque Compensation Delay Time].
- Increase the setting value of *n2-03 [Automatic Freq Regulator Time 2]* proportional to *C4-06*.

■ C4-07: Motor 2 Torque Compensation Gain

No. (Hex.)	Name	Description	Default (Range)
C4-07 (0341) RUN	Motor 2 Torque Compensation Gain	V/f CL-V/f OLV CLV AOLV OLV/PM AOLV/PM CLV/PM EZOLV Sets the gain for motor 2 torque compensation function when using the Motor Switch function.	1.00 (0.00 - 2.50)

In V/f Control or CL-V/f Control, adjust the value in 0.05 unit increments for these conditions:

- When torque is not sufficient during low-speed operation of 10 Hz or less, increase the setting value
- When there is vibration in the motor or when the motor hunts when operating the drive with a light load, decrease the setting value
- When you use a long motor cable, increase the setting.

Note:

- Adjust *C4-07* and make sure that the output current is not more than the drive rated current during low-speed operation.
- When $A1-02 = 2$ [Open Loop Vector], usually it is not necessary to change this setting. If you change this parameter in that control method, it can decrease the torque precision.

■ C4-19: Torque Ripple Suppress Min Freq

No. (Hex.)	Name	Description	Default (Range)
C4-19 (0B8D) RUN Expert	Torque Ripple Suppress Min Freq	V/f CL-V/f OLV CLV AOLV OLV/PM AOLV/PM CLV/PM EZOLV Adjust this if slow oscillation occurs at low speeds. Increase this parameter in 1.0 Hz increments when current ripples and torque ripples occur during low-speed operation. Set this parameter to 0.0 to disable the function if increasing the value does not fix the problem. Usually it is not necessary to change this setting.	0.1 Hz (0.0 - 10.0 Hz)

Note:

Set C4-20 [Voltage Compensation Adjust 1] $\neq 0$ to enable this parameter.

■ **C4-20: Voltage Compensation Adjust 1**

No. (Hex.)	Name	Description	Default (Range)
C4-20 (0BCB) Expert	Voltage Compensation Adjust 1	V/f CL-V/f OLV CLV AOLV OLV/PM AOLV/PM CLV/PM EZOLV Sets voltage precision compensation. Usually it is not necessary to change this setting.	120 (0 - 200)

Note:

Set C4-20 = 0 when noise occurs during low-speed operation.

■ **C4-21: Voltage Compensation Adjust 2**

No. (Hex.)	Name	Description	Default (Range)
C4-21 (0BCC) RUN Expert	Voltage Compensation Adjust 2	V/f CL-V/f OLV CLV AOLV OLV/PM AOLV/PM CLV/PM EZOLV Sets voltage precision compensation. Usually it is not necessary to change this setting.	5 (0 - 10)

Note:

Set C4-21 = 0 when noise occurs during high-speed operation.

■ **C4-23: Current Control Gain**

No. (Hex.)	Name	Description	Default (Range)
C4-23 (1583) RUN Expert	Current Control Gain	V/f CL-V/f OLV CLV AOLV OLV/PM AOLV/PM CLV/PM EZOLV Current control gain. Usually it is not necessary to change this parameter.	1.00 (0.50 - 2.50)

◆ **C5: Auto Speed Regulator (ASR)**

The ASR adjusts the output frequency or torque reference to decrease the difference between frequency reference and motor speed. The control method sets the parameter that you must adjust.

A1-02 [Control Method Selection]	Targets of Adjustment
1: Closed Loop V/f Control (CL-V/f)	Output Frequency
• 3: Closed Loop Vector Control (CLV) • 4: Advanced Open Loop Vector Control (AOLV) • 6: PM Advanced Open Loop Vector Control (AOLV/PM) • 7: PM Closed Loop Vector Control (CLV/PM) • 8: EZ Vector Control (EZOLV)	Torque Reference

The speed control block diagrams of the respective control methods are shown in [Figure 12.53](#) and [Figure 12.54](#).

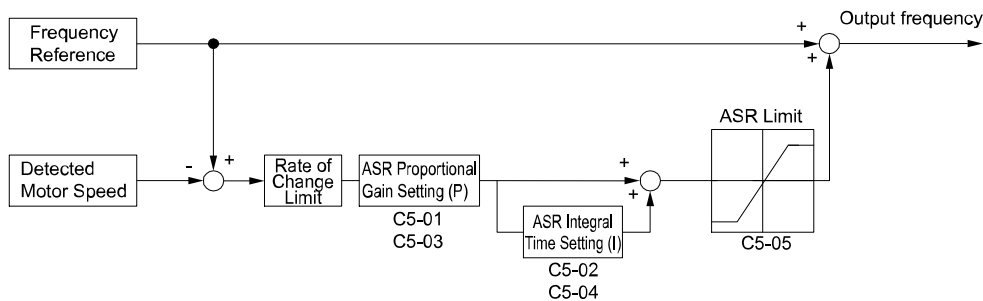

Figure 12.53 Speed Control Block Diagram for CL-V/f

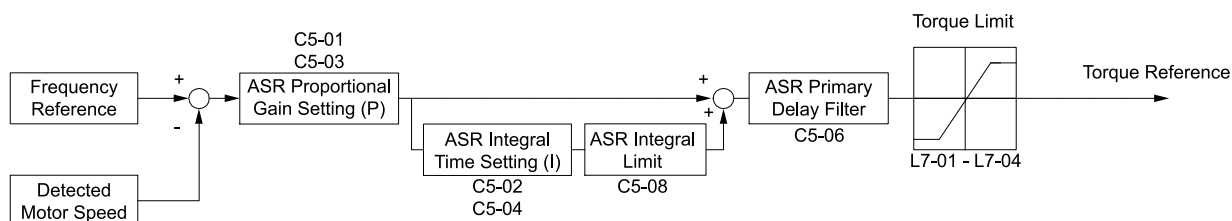

Figure 12.54 Speed Control Block Diagrams for CLV, AOLV, CLV/PM, AOLV/PM, and EZOLV

Note:

The detected speed is the speed estimation value when configured such that $A1-02 = 4, 6, \text{ or } 8$ [Control Method Selection = AOLV, AOLV/PM, or EZOLV].

■ Before You Adjust ASR Parameters

- Do Auto-Tuning and set up all motor data correctly.
- Always make adjustments with the load connected to the motor.
- Use analog output signals to monitor $U1-16$ [SFS Output Frequency] and $U1-05$ [Motor Speed] when you adjust the ASR.

■ ASR Adjustment Procedure for CL-V/f

Do this procedure to adjust ASR parameters:

1. Run the motor at minimum speed and increase $C5-03$ [ASR Proportional Gain 2] as much as possible without oscillation.

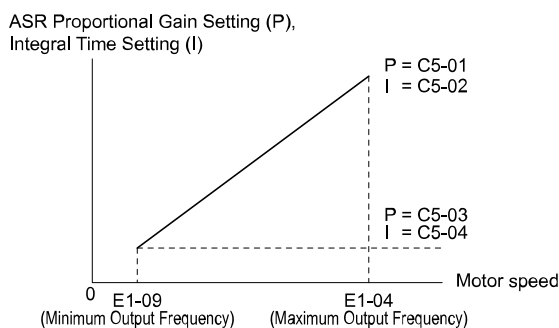

Figure 12.55 ASR Gain and Integral Time Adjustment

2. Run the motor at minimum speed and decrease $C5-04$ [ASR Integral Time 2] as much as possible without oscillation.
3. Check the output current monitor to make sure that the output current is less than 50% of the drive rated current. If the setting value is higher than 50%, decrease $C5-03$ and increase $C5-04$.
4. Run the motor at maximum speed and increase $C5-01$ [ASR Proportional Gain 1] as much as possible without oscillations.
5. Run the motor at maximum speed and decrease $C5-02$ [ASR Integral Time 1] as much as possible without oscillations.
6. If higher speed precision and faster response during acceleration or deceleration are necessary, set $C5-12 = 1$ [Integral Operation @ Accel/Decel = Enabled] to enable integral control during acceleration/decel.

Note:

- If overshooting occurs when acceleration ends, decrease the value set in $C5-01$ and increase the value set in $C5-02$.
- If there is undershoot at stop, decrease $C5-03$ and increase $C5-04$.
- If you adjust the gain and it does not correct overshooting and undershooting, decrease the value set in $C5-05$ [ASR Limit] to decrease the upper limit of the frequency reference compensation.

■ ASR Adjustment Procedure for CLV, AOLV, AOLV/PM, CLV/PM, and EZOLV

Do this procedure to adjust ASR parameters:

1. Run the motor at zero speed or low speed and increase $C5-01$ [ASR Proportional Gain 1] until immediately before vibration starts to occur.

2. Run the motor at zero speed or low speed and decrease *C5-02* [ASR Integral Time 1] until immediately before vibration starts to occur.
3. Check for oscillation when you run the motor at maximum speed.
4. If oscillation occurs, increase *C5-02* and decrease *C5-01*.
When there is no oscillation, the adjustment procedure is complete.
5. Set the low-speed gain. Run the motor at zero speed or low speed and increase *C5-03* [ASR Proportional Gain 2] until immediately before vibration starts to occur.

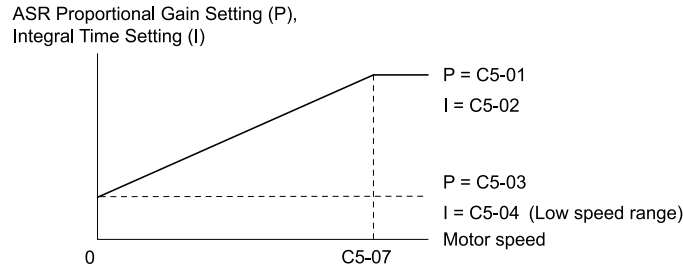

Figure 12.56 Low-speed/High-speed Gain Settings

6. Set the low-speed integral time. Run the motor at zero speed or low speed and decrease *C5-04* [ASR Integral Time 2] until immediately before vibration starts to occur.
7. Set *C5-07* [ASR Gain Switchover Frequency].
8. Check for oscillation when you run the motor at speeds more than the setting in *C5-07*.

Note:

- If overshooting occurs when acceleration ends, decrease the value set in *C5-01* and increase the value set in *C5-02*.
- If there is undershoot at stop, decrease *C5-03* and increase *C5-04*.

■ Use MFDI Switch for Proportional Gain

Note:

If *A1-02* = 1 [Control Method Selection = V/f Control with Encoder], you cannot use this function.

You can use the input terminals set for ASR Gain (*C5-03*) Select [*H1-xx* = 77] to switch the proportional gains set with *C5-01* and *C5-03*. When the configured input terminal is deactivated, the proportional gain set for *C5-01* is selected. When the terminal is activated, the proportional gain set for *C5-03* is selected. The proportional gain changes linearly over the time set in *C5-02* [ASR Integral Time 1]. The signals from this MFDI are more important than *C5-07* [ASR Gain Switchover Frequency].

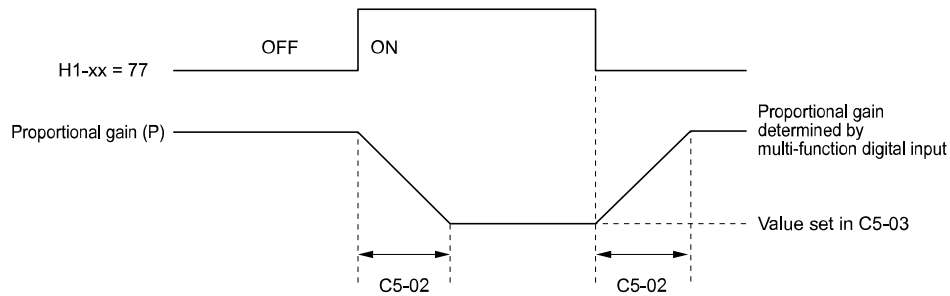

Figure 12.57 Proportional Gain through Multi-function Digital Input Switch

■ Speed Waveform Monitoring Method

To make small adjustments of ASR parameters, monitor the speed waveforms when you make the adjustments. [Table 12.32](#) shows example settings of parameters to monitor speed waveforms.

Table 12.32 Example Settings of MFAO Terminals to Monitor Speed Waveforms

No.	Name	Setting Value	Description
H4-01	Terminal FM Analog Output Select	116	Lets you use terminal FM to monitor U1-16 [SFS Output Frequency].
H4-02	Terminal FM Analog Output Gain	100.0%	
H4-03	Terminal FM Analog Output Bias	0.0%	
H4-04	Terminal AM Analog Output Select	105	Lets you use the terminal AM to monitor U1-05 [Motor Speed].
H4-05	Terminal AM Analog Output Gain	50.0%	
H4-06	Terminal AM Analog Output Bias	0.0%	
H4-07	Terminal FM Signal Level Select	1	Lets you monitor in a -10 to +10 V range.
H4-08	Terminal AM Signal Level Select	1	

These settings cause this MFAO configuration. The MFAO common is terminal AC:

- Terminal FM: Outputs the output frequency after SFS in a -10 V to +10 V (-100% to +100%) range.
- Terminal AM: Outputs the motor speed in a -10 V to +10 V (-200% to +200%) range.

Yaskawa recommends that you monitor the output frequency after SFS and the motor speed for delays in response and differences in reference values.

■ Adjust ASR Parameters

Use Table 12.33 to adjust ASR. The table shows the parameters for motor 1. To operate motor 2, set the motor 2 parameters in the same method.

Note:

When adjusting the proportional gain and integral time, adjust the proportional gain first.

Table 12.33 ASR Response and Possible Solutions

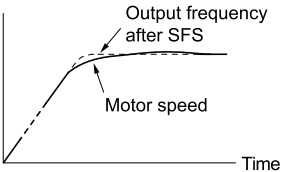
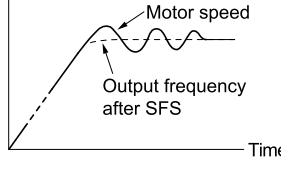
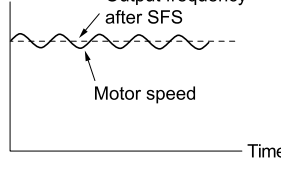
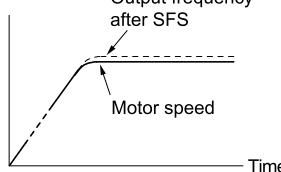
Problem		Possible Solutions
Speed response is slow.		<ul style="list-style-type: none"> • Increase C5-01/C5-03 [ASR Proportional Gain]. • Decrease C5-02/C5-04 [ASR Integral Time].
Overshoot or undershoot occurs at the end of acceleration or deceleration.		<ul style="list-style-type: none"> • Decrease C5-01/C5-03. • Increase C5-02/C5-04.
Vibration and oscillation occur at constant speed.		<ul style="list-style-type: none"> • Decrease C5-01/C5-03. • Increase C5-02/C5-04. • Increase C5-06 [ASR Delay Time].
Speed accuracy is unsatisfactory when you operate a motor that has a large quantity of rated slip in Closed Loop V/f Control.		<ul style="list-style-type: none"> • Check the pulse number set to F1-01 [Encoder 1 Pulse Count (PPR)] and the gear ratio set to F1-12 [Encoder 1 Gear Teeth 1] and F1-13 [Encoder 1 Gear Teeth 2]. • Make sure that you correctly set the pulse signal from the encoder. • Check U6-04 [ASR Output] to make sure that the ASR operates at its output limit set to C5-05 [ASR Limit]. If the ASR is at the output limit, increase C5-05.

Problem		Possible Solutions
If C5-12 = 1 or C5-32 = 1 [Enabled] in Closed Loop V/f Control, over/undershoot occurs when you change speeds.	-	<ul style="list-style-type: none"> Decrease C5-01/C5-03. Increase C5-02/C5-04. Decrease the value set to C5-05.
Oscillation at low speed and response is too slow at high speed. Oscillation at high speed and response is too slow at low speed.	-	<ul style="list-style-type: none"> Closed Loop V/f Control Mode: Use C5-03 and C5-04 at maximum speed and C5-01 and C5-02 at minimum speed to set different ASR settings. Closed Loop Vector Control, PM Advanced Open Loop Vector Control, and PM Closed Loop Vector Control: Use C5-01 to C5-04 to set the best ASR settings for high and low speed. Use C5-07 [ASR Gain Switchover Frequency] to switch the ASR proportional gain and ASR integral time as specified by the output frequency.

■ C5-01: ASR Proportional Gain 1

No. (Hex.)	Name	Description	Default (Range)
C5-01 (021B) RUN	ASR Proportional Gain 1	<div style="display: flex; justify-content: space-between; font-size: small;"> V/f CL-V/f OLV CLV AOLV OLV/PM AOLV/PM CLV/PM EZOLV </div> Sets the gain to adjust ASR response.	Determined by A1-02 (0.00 - 300.00)

A higher gain provides a higher speed response. Usually, the gain increases with larger loads. Too much gain will cause vibration.

Note:

- The drive usually sets Motor 1 ASR with C5-01 and C5-02 [ASR Integral Time 1]. You can switch between C5-01 and C5-03 [ASR Proportional Gain 2] by setting H1-xx = 77 [MFDI Function Selection = ASR Gain (C5-03) Select]. You can also use C5-01 and C5-02 as alternatives to C5-03 and C5-04, respectively, when the speed is less than or equal to the frequency set in C5-07 [ASR Gain Switchover Frequency].
- The drive automatically adjusts C5-01 in ASR Tuning.

■ C5-02: ASR Integral Time 1

No. (Hex.)	Name	Description	Default (Range)
C5-02 (021C) RUN	ASR Integral Time 1	<div style="display: flex; justify-content: space-between; font-size: small;"> V/f CL-V/f OLV CLV AOLV OLV/PM AOLV/PM CLV/PM EZOLV </div> Sets the ASR integral time.	Determined by A1-02 (0.000 - 60.000 s)

When you increase the integral time, the responsiveness will decrease. An integral time that is too short can cause oscillation.

■ C5-03: ASR Proportional Gain 2

No. (Hex.)	Name	Description	Default (Range)
C5-03 (021D) RUN	ASR Proportional Gain 2	<div style="display: flex; justify-content: space-between; font-size: small;"> V/f CL-V/f OLV CLV AOLV OLV/PM AOLV/PM CLV/PM EZOLV </div> Sets the gain to adjust ASR response.	Determined by A1-02 (0.00 - 300.00)

A higher gain provides a higher speed response. Usually, the gain increases with larger loads. Too much gain will cause vibration.

■ C5-04: ASR Integral Time 2

No. (Hex.)	Name	Description	Default (Range)
C5-04 (021E) RUN	ASR Integral Time 2	<div style="display: flex; justify-content: space-between; font-size: small;"> V/f CL-V/f OLV CLV AOLV OLV/PM AOLV/PM CLV/PM EZOLV </div> Sets the ASR integral time.	Determined by A1-02 (0.000 - 60.000 s)

When you increase the integral time, the responsiveness will decrease. An integral time that is too short can cause oscillation.

■ C5-05: ASR Limit

No. (Hex.)	Name	Description	Default (Range)
C5-05 (021F)	ASR Limit	V/f <input type="checkbox"/> CL-V/f <input checked="" type="checkbox"/> OLV <input type="checkbox"/> CLV <input type="checkbox"/> AOLV <input type="checkbox"/> OLV/PM <input type="checkbox"/> AOLV/PM <input type="checkbox"/> CLV/PM <input type="checkbox"/> EZOLV <input type="checkbox"/> Set the ASR output limit as a percentage of E1-04 [Maximum Output Frequency].	5.0% (0.0 - 20.0%)

If the motor rated slip is high, it is necessary to increase the setting for correct motor speed control. Use U6-04 [ASR Output] to make sure that ASR is operating at the limit set in this parameter. When ASR is operating at the limit, correctly set the PG signal and these parameters before you make changes to C5-05.

- F1-01 [Encoder 1 Pulse Count (PPR)]
- F1-12 [Encoder 1 Gear Teeth 1]
- F1-13 [Encoder 1 Gear Teeth 2]

■ C5-06: ASR Delay Time

No. (Hex.)	Name	Description	Default (Range)
C5-06 (0220)	ASR Delay Time	V/f <input type="checkbox"/> CL-V/f <input type="checkbox"/> OLV <input type="checkbox"/> CLV <input checked="" type="checkbox"/> AOLV <input type="checkbox"/> OLV/PM <input type="checkbox"/> AOLV/PM <input type="checkbox"/> CLV/PM <input type="checkbox"/> EZOLV <input type="checkbox"/> Sets the filter time constant of the torque reference output from the speed loop. Usually it is not necessary to change this setting.	Determined by A1-02 (0.000 - 0.500 s)

If you have a load with low rigidity or if oscillation is a problem, decrease C5-01 in 2-unit decrements or decrease C5-06 in 0.001-unit decrements.

■ C5-07: ASR Gain Switchover Frequency

No. (Hex.)	Name	Description	Default (Range)
C5-07 (0221)	ASR Gain Switchover Frequency	V/f <input type="checkbox"/> CL-V/f <input type="checkbox"/> OLV <input type="checkbox"/> CLV <input checked="" type="checkbox"/> AOLV <input type="checkbox"/> OLV/PM <input type="checkbox"/> AOLV/PM <input type="checkbox"/> CLV/PM <input type="checkbox"/> EZOLV <input type="checkbox"/> Sets the frequency where the drive will switch between these parameters: C5-01 and C5-03 [ASR Proportional Gain 1/2] C5-02 and C5-04 [ASR Integral Time 1/2]	Determined by A1-02 (Determined by A1-02)

Switching the proportional gain and integral time in the low or high speed range can help operation become stable. A good switching point is 80% of the frequency where oscillation occurs or at 80% of the maximum output frequency.

Note:

An MFDI set for H1-xx = 77 [MFDI Function Selection = ASR Gain (C5-03) Select] will have priority over the ASR gain switching frequency.

■ C5-08: ASR Integral Limit

No. (Hex.)	Name	Description	Default (Range)
C5-08 (0222)	ASR Integral Limit	V/f <input type="checkbox"/> CL-V/f <input type="checkbox"/> OLV <input type="checkbox"/> CLV <input checked="" type="checkbox"/> AOLV <input type="checkbox"/> OLV/PM <input type="checkbox"/> AOLV/PM <input type="checkbox"/> CLV/PM <input type="checkbox"/> EZOLV <input type="checkbox"/> Set the upper limit of the ASR integral amount as a percentage of the rated load.	400% (0 - 400%)

■ C5-12: Integral Operation @ Accel/Decel

No. (Hex.)	Name	Description	Default (Range)
C5-12 (0386)	Integral Operation @ Accel/Decel	V/f <input type="checkbox"/> CL-V/f <input checked="" type="checkbox"/> OLV <input type="checkbox"/> CLV <input type="checkbox"/> AOLV <input type="checkbox"/> OLV/PM <input type="checkbox"/> AOLV/PM <input type="checkbox"/> CLV/PM <input type="checkbox"/> EZOLV <input type="checkbox"/> Sets ASR integral operation during acceleration and deceleration.	0 (0, 1)

When it is necessary for the motor speed to be as near the frequency reference as possible during acceleration or deceleration, set this parameter to 1.

Note:

If you enable integral control, overshoot or undershoot can occur when acceleration or deceleration complete. If there are problems with overshooting and undershooting, set this parameter to 0.

0 : Disabled

Integral operation is always enabled during constant speed. The drive will not enable integral operation during acceleration or deceleration.

1 : Enabled

Integral operation is always enabled.

■ C5-17: Motor Inertia

No. (Hex.)	Name	Description	Default (Range)
C5-17 (0276) Expert	Motor Inertia	<div style="display: flex; justify-content: space-between; font-size: small;"> V/f CL-V/f OLV CLV AOLV OLV/PM AOLV/PM CLV/PM EZOLV </div> <p>Sets the motor inertia.</p>	Determined by o2-04, C6-01, and E5-01 (0.0001 - 600.00 kgm ²)

Note:

The default settings and the display units for setting ranges are different for different drive models.

- 0.0001 kgm² units (setting range: 0.0001 kgm² to 6.0000 kgm²): 2004 to 2021, 4002 to 4012
- 0.001 kgm² units (setting range: 0.001 kgm² to 60.000 kgm²): 2030 to 2211, 4018 to 4103
- 0.01 kgm² units (setting range: 0.01 kgm² to 600.00 kgm²): 2257 to 2415, 4140 to 4720

When *AI-02 = 3* or *7* [*Control Method Selection = CLV or CLV/PM*], the drive automatically sets *C5-17* to the value of [Motor Inertia] when you do Inertia Tuning or ASR Tuning.

■ C5-18: Load Inertia Ratio

No. (Hex.)	Name	Description	Default (Range)
C5-18 (0277) Expert	Load Inertia Ratio	<div style="display: flex; justify-content: space-between; font-size: small;"> V/f CL-V/f OLV CLV AOLV OLV/PM AOLV/PM CLV/PM EZOLV </div> <p>Sets the load inertia ratio for the motor inertia.</p>	1.0 (0.0 - 6000.0)

When *AI-02 = 3* or *7* [*Control Method Selection = CLV or CLV/PM*], the drive automatically sets *C5-18* to the load inertia ratio when you do Inertia Tuning or ASR Tuning.

■ C5-21: Motor 2 ASR Proportional Gain 1

No. (Hex.)	Name	Description	Default (Range)
C5-21 (0356) RUN	Motor 2 ASR Proportional Gain 1	<div style="display: flex; justify-content: space-between; font-size: small;"> V/f CL-V/f OLV CLV AOLV OLV/PM AOLV/PM CLV/PM EZOLV </div> <p>Sets the gain to adjust ASR response for motor 2.</p>	Determined by E3-01 (0.00 - 300.00)

A higher gain provides a higher speed response. Usually, the gain increases with larger loads. Too much gain will cause vibration.

Note:

- The drive usually sets Motor 2 ASR with *C5-21* and *C5-22* [*Motor 2 ASR Integral Time 1*]. You can also use *C5-23* [*Motor 2 ASR Proportional Gain 2*] instead of *C5-21* when the speed is less than or equal to the frequency set in *C5-27* [*Motor 2 ASR Gain Switchover Freq*]. You can switch between *C5-21* and *C5-23* by setting *H1-xx = 77* [*MFDI Function Selection = ASR Gain (C5-03) Select*].
- The drive automatically adjusts *C5-21* in ASR Tuning.

■ C5-22: Motor 2 ASR Integral Time 1

No. (Hex.)	Name	Description	Default (Range)
C5-22 (0357) RUN	Motor 2 ASR Integral Time 1	<div style="display: flex; justify-content: space-between; font-size: small;"> V/f CL-V/f OLV CLV AOLV OLV/PM AOLV/PM CLV/PM EZOLV </div> <p>Sets the ASR integral time for motor 2.</p>	Determined by E3-01 (0.000 - 60.000 s)

When you increase the integral time, the responsiveness will decrease. An integral time that is too short can cause oscillation.

Note:

The drive usually sets Motor 2 ASR with *C5-21* [*Motor 2 ASR Proportional Gain 1*] and *C5-22*. You can also use *C5-24* [*Motor 2 ASR Integral Time 2*] instead of *C5-22* when the speed is less than or equal to the frequency set in *C5-27* [*Motor 2 ASR Gain Switchover Freq*].

■ C5-23: Motor 2 ASR Proportional Gain 2

No. (Hex.)	Name	Description	Default (Range)
C5-23 (0358) RUN	Motor 2 ASR Proportional Gain 2	V/f <input type="checkbox"/> CL-V/f <input checked="" type="checkbox"/> OLV <input type="checkbox"/> CLV <input checked="" type="checkbox"/> AOLV <input type="checkbox"/> OLV/PM <input type="checkbox"/> AOLV/PM <input type="checkbox"/> CLV/PM <input type="checkbox"/> EZOLV <input type="checkbox"/> Sets the gain to adjust ASR response for motor 2.	Determined by E3-01 (0.00 - 300.00)

A higher gain provides a higher speed response. Usually, the gain increases with larger loads. Too much gain causes vibration.

■ C5-24: Motor 2 ASR Integral Time 2

No. (Hex.)	Name	Description	Default (Range)
C5-24 (0359) RUN	Motor 2 ASR Integral Time 2	V/f <input type="checkbox"/> CL-V/f <input checked="" type="checkbox"/> OLV <input type="checkbox"/> CLV <input checked="" type="checkbox"/> AOLV <input type="checkbox"/> OLV/PM <input type="checkbox"/> AOLV/PM <input type="checkbox"/> CLV/PM <input type="checkbox"/> EZOLV <input type="checkbox"/> Sets the ASR integral time for motor 2.	Determined by E3-01 (0.000 - 60.000 s)

When you increase the integral time, the responsiveness will decrease. An integral time that is too short can cause oscillation.

Note:

The drive usually sets Motor 2 ASR with C5-21 [Motor 2 ASR Proportional Gain 1] and C5-22 [Motor 2 ASR Integral Time 1]. You can also use C5-24 [Motor 2 ASR Integral Time 2] instead of C5-22 when the speed is less than or equal to the frequency set in C5-27 [Motor 2 ASR Gain Switchover Freq].

■ C5-25: Motor 2 ASR Limit

No. (Hex.)	Name	Description	Default (Range)
C5-25 (035A)	Motor 2 ASR Limit	V/f <input type="checkbox"/> CL-V/f <input checked="" type="checkbox"/> OLV <input type="checkbox"/> CLV <input checked="" type="checkbox"/> AOLV <input type="checkbox"/> OLV/PM <input type="checkbox"/> AOLV/PM <input type="checkbox"/> CLV/PM <input type="checkbox"/> EZOLV <input type="checkbox"/> Set the motor 2 ASR output limit as a percentage of E1-04 [Maximum Output Frequency].	5.0% (0.0 - 20.0%)

If the motor rated slip is high, it is necessary to increase the setting for correct motor speed control. Use U6-04 [ASR Output] to make sure that ASR is operating at the limit set in this parameter. When ASR is operating at the limit, correctly set the PG signal and these parameters before you make changes to C5-25.

- F1-31 [Encoder 2 Pulse Count (PPR)]
- F1-33 [Encoder 2 Gear Teeth 1]
- F1-34 [Encoder 2 Gear Teeth 2]

■ C5-26: Motor 2 ASR Delay Time

No. (Hex.)	Name	Description	Default (Range)
C5-26 (035B)	Motor 2 ASR Delay Time	V/f <input type="checkbox"/> CL-V/f <input type="checkbox"/> OLV <input type="checkbox"/> CLV <input checked="" type="checkbox"/> AOLV <input type="checkbox"/> OLV/PM <input type="checkbox"/> AOLV/PM <input type="checkbox"/> CLV/PM <input type="checkbox"/> EZOLV <input type="checkbox"/> Sets the motor 2 filter time constant of the torque reference output from the speed loop. Usually it is not necessary to change this setting.	Determined by E3-01 (0.000 - 0.500 s)

If you have a load with low rigidity or if oscillation is a problem, decrease C5-21 in 2-unit decrements or decrease C5-26 in 0.001-unit decrements.

■ C5-27: Motor 2 ASR Gain Switchover Freq

No. (Hex.)	Name	Description	Default (Range)
C5-27 (035C)	Motor 2 ASR Gain Switchover Freq	V/f <input type="checkbox"/> CL-V/f <input type="checkbox"/> OLV <input type="checkbox"/> CLV <input checked="" type="checkbox"/> AOLV <input type="checkbox"/> OLV/PM <input type="checkbox"/> AOLV/PM <input type="checkbox"/> CLV/PM <input type="checkbox"/> EZOLV <input type="checkbox"/> Sets the frequency where the drive will switch between these parameters: C5-21 and C5-23 [Motor 2 ASR Proportional Gain 1/2] C5-22 and C5-24 [Motor 2 ASR Integral Time 1/2]	0.0 (0.0 - 400.0)

Switching the proportional gain and integral time in the low or high speed range can help operation become stable. A good switching point is 80% of the frequency where oscillation occurs or at 80% of the maximum output frequency.

Note:

An MFDI set for $H1-xx = 77$ [MFDI Function Selection = ASR Gain (C5-03) Select] will have priority over the ASR gain switching frequency.

■ **C5-28: Motor 2 ASR Integral Limit**

No. (Hex.)	Name	Description	Default (Range)
C5-28 (035D)	Motor 2 ASR Integral Limit	<div style="display: flex; justify-content: space-between; font-size: small;"> V/f CL-V/f OLV CLV AOLV OLV/PM AOLV/PM CLV/PM EZOLV </div> Set the upper limit of the motor 2 ASR integral amount as a percentage of the rated load.	400% (0 - 400%)

■ **C5-29: Speed Control Response**

No. (Hex.)	Name	Description	Default (Range)
C5-29 (0B18) Expert	Speed Control Response	<div style="display: flex; justify-content: space-between; font-size: small;"> V/f CL-V/f OLV CLV AOLV OLV/PM AOLV/PM CLV/PM EZOLV </div> Sets the level of speed control responsiveness. Usually it is not necessary to change this setting.	0 (0, 1)

If a high level of speed control responsiveness is necessary, set $C5-29 = 1$, then adjust the speed control (ASR) parameter.

0 : Standard

1 : High Performance 1

■ **C5-32: Motor 2 Integral Oper at Acc/Dec**

No. (Hex.)	Name	Description	Default (Range)
C5-32 (0361)	Motor 2 Integral Oper at Acc/Dec	<div style="display: flex; justify-content: space-between; font-size: small;"> V/f CL-V/f OLV CLV AOLV OLV/PM AOLV/PM CLV/PM EZOLV </div> Sets ASR integral operation during acceleration and deceleration for motor 2.	0 (0, 1)

When it is necessary for the motor speed to be as near the frequency reference as possible during acceleration or deceleration, set this parameter to 1.

Note:

If you enable integral control, overshoot or undershoot can occur when acceleration or deceleration complete. If there are problems with overshooting and undershooting, set this parameter to 0.

0 : Disabled

Integral operation is not enabled during acceleration or deceleration. Integral operation is always enabled during constant speed.

1 : Enabled

Integral operation is always enabled.

■ **C5-37: Motor 2 Inertia**

No. (Hex.)	Name	Description	Default (Range)
C5-37 (0278) Expert	Motor 2 Inertia	<div style="display: flex; justify-content: space-between; font-size: small;"> V/f CL-V/f OLV CLV AOLV OLV/PM AOLV/PM CLV/PM EZOLV </div> Sets the motor inertia for motor 2.	Determined by o2-04, C6-01 (0.0001 - 600.00 kgm ²)

Note:

The default settings and the display units for setting ranges are different for different drive models.

- 0.0001 kgm² units (setting range: 0.0001 kgm² to 6.0000 kgm²): 2004 to 2021, 4002 to 4012
- 0.001 kgm² units (setting range: 0.001 kgm² to 60.0000 kgm²): 2030 to 2211, 4018 to 4103
- 0.01 kgm² units (setting range: 0.01 kgm² to 600.00 kgm²): 2257 to 2415, 4140 to 4720

The drive automatically sets C5-37 to the value of [Motor Inertia] when you do Inertia Tuning or ASR Tuning.

■ C5-38: Motor 2 Load Inertia Ratio

No. (Hex.)	Name	Description	Default (Range)
C5-38 (0279) Expert	Motor 2 Load Inertia Ratio	V/f CL-V/f OLV CLV AOLV OLV/PM AOLV/PM CLV/PM EZOLV Sets the load inertia ratio for the motor 2 inertia.	1.0 (0.0 - 6000.0)

The drive automatically sets C5-38 to the value of [Load Inertia Ratio] when you do Inertia Tuning or ASR Tuning.

■ C5-39: ASR Primary Delay Time Const 2

No. (Hex.)	Name	Description	Default (Range)
C5-39 (030D)	ASR Primary Delay Time Const 2	V/f CL-V/f OLV CLV AOLV OLV/PM AOLV/PM CLV/PM EZOLV Sets the filter time constant used when the torque reference is output from ASR. Usually it is not necessary to change this parameter.	0.000 s (0.000 - 0.500 s)

If you have a load with low rigidity or if oscillation is a problem, increase this setting in 0.01 unit increments.

■ C5-50: Notch Filter Frequency

No. (Hex.)	Name	Description	Default (Range)
C5-50 (0B14) Expert	Notch Filter Frequency	V/f CL-V/f OLV CLV AOLV OLV/PM AOLV/PM CLV/PM EZOLV Sets the machine resonance frequency.	0 Hz (0, or 2 to 100 Hz)

Machine resonance can cause high-frequency noise and vibration during operation. A notch filter can help prevent the noise and vibration. Notch filters set the resonant frequency of the machine to remove specific vibrational frequency components caused by machine resonance.

Note:

- Correctly set the value for the notch filter frequency. If the frequency value is too low for the speed loop response frequency, the speed control function will not function correctly. Set the frequency to be a minimum of 4 times the speed loop response frequency.
- Set C5-50 = 0 [0 Hz] to disable the notch filter.

■ C5-51: Notch Filter Bandwidth

No. (Hex.)	Name	Description	Default (Range)
C5-51 (0B15) Expert	Notch Filter Bandwidth	V/f CL-V/f OLV CLV AOLV OLV/PM AOLV/PM CLV/PM EZOLV Sets the notch width of the notch filter.	1.0 (0.5 - 5.0)

Note:

Set C5-50 = 0 [Notch Filter Frequency = 0 Hz] to disable the notch filter.

◆ C6: Duty & Carrier Frequency

C6 parameters are used to set the selection of drive duty rating, selection of carrier frequency, and upper and lower limits of carrier frequencies.

■ C6-01: Normal / Heavy Duty Selection

No. (Hex.)	Name	Description	Default (Range)
C6-01 (0223)	Normal / Heavy Duty Selection	V/f CL-V/f OLV CLV AOLV OLV/PM AOLV/PM CLV/PM EZOLV Sets the drive duty rating.	1 (0, 1)

0 : Heavy Duty Rating

The overload tolerance is 150% of the rated output current for 60 seconds.

1 : Normal Duty Rating

12.4 C: Tuning

The overload tolerance is 110% of the rated output current for 60 seconds.

There are two types of load ratings for this product depending on the load characteristics of the application: Heavy Duty Rating (HD) and Normal Duty Rating (ND).

The drive rated output current, overload tolerance, and acceleration stall prevention level change when the duty rating changes. Set the drive to agree with the duty rating of the selected drive capacity. In HD, the tolerance is 150% overload for 60 seconds. In ND, the tolerance is 110% overload for 60 seconds. The rated output current for ND drives is higher than the rated output current for HD drives. Refer to “Model Specifications (200 V Class)” and “Model Specifications (400 V Class)” for more information about rated output current.

Table 12.34 Differences between Heavy Duty Rating and Normal Duty Rating

Item	Heavy Duty Rating (HD)	Normal Duty Rating (ND)
C6-01 Setting	0	1
Load Characteristics		
Application	<p>A high overload tolerance is necessary during start up, acceleration, deceleration, and equivalent conditions.</p> <ul style="list-style-type: none"> • Extruder • Conveyor • Constant torque or high overload capacity are necessary. 	<p>Overload tolerance is not necessary.</p> <ul style="list-style-type: none"> • Fan • Pump • Blower
Overload Tolerance	150% - 60 seconds	110% - 60 seconds
Stall Prevent Level during Accel	150%	110%
Stall Prevent Level during Run	150%	110%
Carrier Frequency	2 kHz	2 kHz Swing-PWM

Note:

- Set the stall prevention level during acceleration with *L3-02* and the stall prevention level during run with *L3-06*.
- Changing *C6-01* also changes the maximum capacity of applicable drive motors. The drive automatically changes the setting values *E2-xx* and *E4-xx* to applicable values. The drive also automatically changes these parameters that depend on motor output:
 - b8-04* [Energy Saving Coefficient Value]
 - C5-17* [Motor Inertia]
 - C5-37* [Motor 2 Inertia]
 - L2-03* [Minimum Baseblock Time]
 - L3-24* [Motor Accel Time @ Rated Torque]
 - n5-02* [Motor Inertia Acceleration Time]

■ C6-02: Carrier Frequency Selection

No. (Hex.)	Name	Description	Default (Range)
C6-02 (0224)	Carrier Frequency Selection	V/f CL-V/f OLV CLV AOLV OLV/PM AOLV/PM CLV/PM EZOLV Sets the carrier frequency for the transistors in the drive.	Determined by A1-02, C6-01, and o2-04 (Determined by A1-02)

Changes to the switching frequency will decrease audible noise and decrease leakage current.

Note:

Increasing the carrier frequency to more than the default setting will automatically decrease the drive current rating.

1 : 2.0 kHz

2 : 5.0 kHz (4.0 kHz AOLV/PM)

3 : 8.0 kHz (6.0 kHz AOLV/PM)

4 : 10.0 kHz (8.0 kHz AOLV/PM)

5 : 12.5 kHz (10.0 kHz AOLV/PM)

6 : 15.0 kHz (12.0 kHz AOLV/PM)

7 : Swing PWM1 (Audible Sound 1)

8 : Swing PWM2 (Audible Sound 2)

9 : Swing PWM3 (Audible Sound 3)

A : Swing PWM4 (Audible Sound 4)

F : User Defined (C6-03 to C6-05)

Use *C6-03 to C6-05* to set detailed setting values.

Note:

- The carrier frequency for Swing PWM 1 is equivalent to 2.0 kHz. Swing PWM applies a special PWM pattern to decrease the audible noise.
- The setting range changes when the *A1-02 [Control Method Selection]* value changes:
 - 3, 5, 7, 8 [*CLV, OLV/PM, CLV/PM, EZOLV*]: You cannot set to 7 to A.
 - 4 [*AOLV*]: You cannot set to 6, 7 to A, or F.
 - 6 [*AOLV/PM*]: You cannot set to 7 to A or F.

Table 12.35 Guidelines for Carrier Frequency Parameter Setup

Symptom	Remedy
Speed and torque are not stable at low speed.	Decrease the carrier frequency.
Speed and torque are not stable at low speed.	Decrease the carrier frequency.
Too much leakage current from the drive.	Decrease the carrier frequency.
Wiring between the drive and motor is too long.	Decrease the carrier frequency. Note: If the motor cable is too long, it can be necessary to decrease the carrier frequency. Refer to Table 12.36 for the wiring distance and decrease the carrier frequency.
Audible motor noise is too loud.	Increase the carrier frequency. Use Swing PWM. Note: The default carrier frequency in ND is Swing PWM 1 (<i>C6-02 = 7</i>), with a 2 kHz base. You can increase the carrier frequency in Normal Duty mode, but this will also decrease the drive rated current.

Table 12.36 Wiring Distance

Wiring Distance	Up to 50 m	Up to 100 m	Greater than 100 m
C6-02 [Carrier Frequency Selection]	1 to F (up to 15 kHz)	1 to 2 (up to 5 kHz), 7	1 (up to 2 kHz), 7

Note:

When *A1-02 = 5 or 6 [Control Method Selection = OLV/PM or AOLV/PM]*, the maximum cable length is 100 m (328 ft).

■ C6-03: Carrier Frequency Upper Limit

No. (Hex.)	Name	Description	Default (Range)
C6-03 (0225)	Carrier Frequency Upper Limit	<div style="display: flex; justify-content: space-between; font-size: small;"> V/f CL-V/f OLV CLV AOLV OLV/PM AOLV/PM CLV/PM EZOLV </div> Sets the upper limit of the carrier frequency. Set <i>C6-02 = F [Carrier Frequency Selection = User Defined (C6-03 to C6-05)]</i> to set this parameter.	Determined by C6-02 (1.0 - 15.0 kHz)

Setting a Fixed User-Defined Carrier Frequency

When you cannot use *C6-02* to set a carrier frequency between set selectable values, you can set the value in *C6-03*. The carrier frequency will be fixed to the value set to *C6-03*.

When *A1-02 = 0, 1 [Control Method Selection = V/f, CL-V/f]*, set *C6-03 = C6-04 [Carrier Frequency Lower Limit]* to fix the carrier frequency.

Setting a Variable Carrier Frequency to Agree with the Output Frequency

When *A1-02 = 0, 1*, set *C6-03, C6-04, and C6-05 [Carrier Freq Proportional Gain]* as shown in [Figure 12.58](#) to make the carrier frequency change linearly with the output frequency.

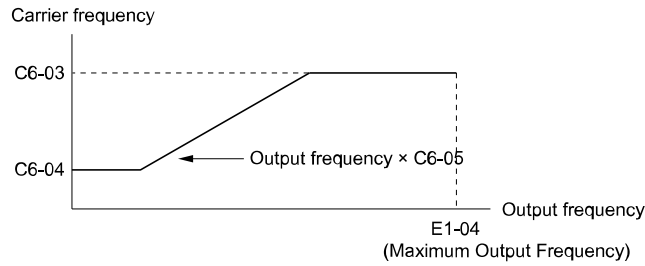

Figure 12.58 Setting a Variable Carrier Frequency to Agree with the Output Frequency

Note:

- When $C6-05 \leq 7$, the drive disables $C6-04$. The carrier frequency is fixed to the value set to $C6-03$.
- The drive detects *oPE11 [Carrier Frequency Setting Error]* when these conditions are correct at the same time:
 - $C6-05 \geq 6$
 - $C6-04 \geq C6-03$

■ C6-04: Carrier Frequency Lower Limit

No. (Hex.)	Name	Description	Default (Range)
C6-04 (0226)	Carrier Frequency Lower Limit	<input type="checkbox"/> V/f <input checked="" type="checkbox"/> CL-V/f <input type="checkbox"/> OLV <input type="checkbox"/> CLV <input type="checkbox"/> AOLV <input type="checkbox"/> OLV/PM <input type="checkbox"/> AOLV/PM <input type="checkbox"/> CLV/PM <input type="checkbox"/> EZOLV Sets the lower limit of the carrier frequency. Set $C6-02 = F$ [<i>Carrier Frequency Selection = User Defined (C6-03 to C6-05)</i>] to set this parameter.	Determined by C6-02 (1.0 - 15.0 kHz)

Set $C6-03$ [*Carrier Frequency Upper Limit*], $C6-04$, and $C6-05$ [*Carrier Freq Proportional Gain*] to make the carrier frequency change linearly with the output frequency.

Note:

- The drive detects *oPE11 [Carrier Frequency Setting Error]* when these conditions are correct at the same time:
- $C6-04 \geq C6-03$
 - $C6-05 \geq 6$

■ C6-05: Carrier Freq Proportional Gain

No. (Hex.)	Name	Description	Default (Range)
C6-05 (0227)	Carrier Freq Proportional Gain	<input type="checkbox"/> V/f <input checked="" type="checkbox"/> CL-V/f <input type="checkbox"/> OLV <input type="checkbox"/> CLV <input type="checkbox"/> AOLV <input type="checkbox"/> OLV/PM <input type="checkbox"/> AOLV/PM <input type="checkbox"/> CLV/PM <input type="checkbox"/> EZOLV Sets the proportional gain for the carrier frequency. Set $C6-02 = F$ [<i>Carrier Frequency Selection = User Defined (C6-03 to C6-05)</i>] to set this parameter.	Determined by C6-02 (0 - 99)

Set $C6-03$ [*Carrier Frequency Upper Limit*], $C6-04$ [*Carrier Frequency Lower Limit*], and $C6-05$ to make the carrier frequency change linearly with the output frequency.

■ C6-09: Carrier Freq at Rotational Tune

No. (Hex.)	Name	Description	Default (Range)
C6-09 (022B)	Carrier Freq at Rotational Tune	<input type="checkbox"/> V/f <input type="checkbox"/> CL-V/f <input checked="" type="checkbox"/> OLV <input type="checkbox"/> CLV <input type="checkbox"/> AOLV <input type="checkbox"/> OLV/PM <input type="checkbox"/> AOLV/PM <input type="checkbox"/> CLV/PM <input type="checkbox"/> EZOLV Sets the Auto-Tuning carrier frequency. Usually it is not necessary to change this setting.	0 (0, 1)

If you set $C6-09 = 0$ for a high-frequency or low-impedance motor, it can cause *oC [Overcurrent]*. To prevent *oC*, set the carrier frequency to a high value and set $C6-09 = 1$ before you do Auto-Tuning.

The procedure to set the carrier frequency when the $A1-02$ [*Control Method Selection*] setting changes.

- When $A1-02 = 2, 3$ [*OLV, CLV*], set $C6-02 = F$ [*Carrier Frequency Selection = User Defined (C6-03 to C6-05)*] and then increase the value set to $C6-03$ [*Carrier Frequency Upper Limit*].
- When $A1-02 = 4$ to 7 [*AOLV, OLV/PM, AOLV/PM, or CLV/PM*], use $C6-02$ to increase the carrier frequency.

0 : 5kHz

Note:

When $A1-02 = 5, 6, 7$ [*Control Method Selection = OLV/PM, AOLV/PM, CLV/PM*], the carrier frequency is 2 kHz.

1 : use C6-03

Note:

When $A1-02 = 5, 6, 7$ [*Control Method Selection = OLV/PM, AOLV/PM, CLV/PM*], the carrier frequency is as specified in $C6-02$.

12.5 d: References

d parameters [References] set the frequency reference input method and dead band range. They also set torque control, field weakening, and field forcing functions.

WARNING! Sudden Movement Hazard. Use fast stop circuits to safely and quickly stop the drive. After you wire the fast stop circuits, you must check their operation. Test the operation of the fast stop function before you use the drive. If you do not test the fast stop circuit before you operate the drive, it can cause serious injury or death.

◆ d1: Frequency Reference

Figure 12.59 shows the frequency reference input method, command source selection method and priority descriptions.

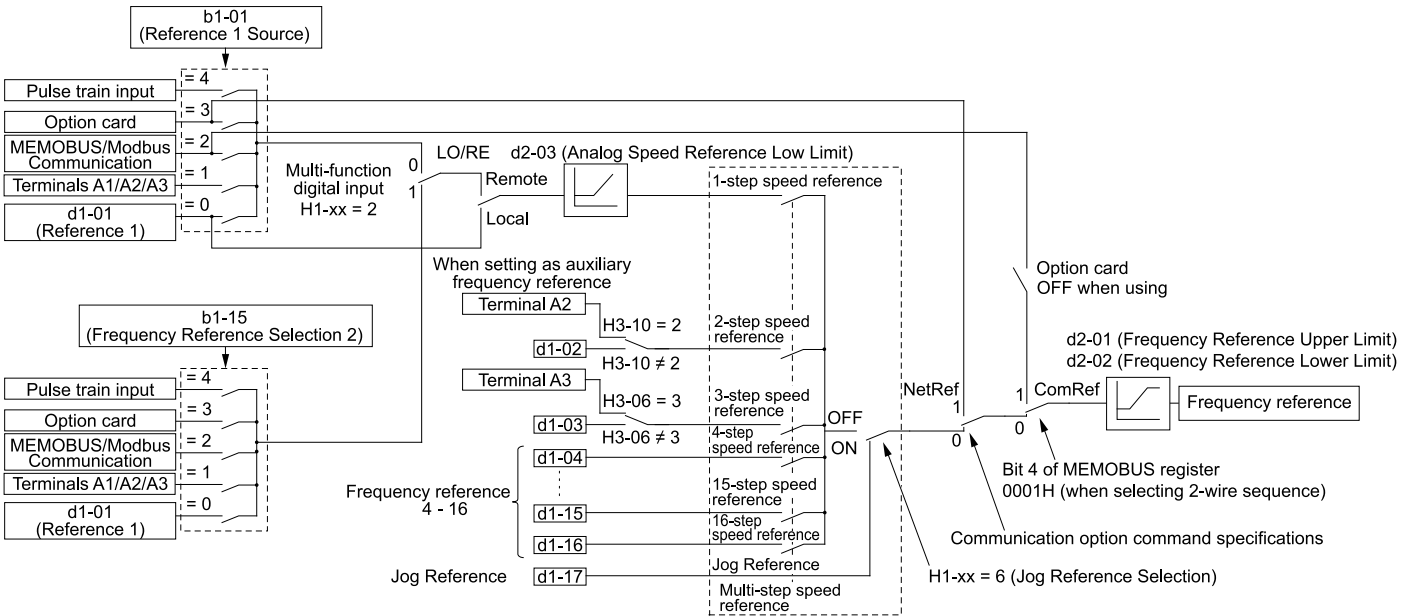

Figure 12.59 Frequency Reference Setting Hierarchy

■ Multi-Step Speed Operation

The drive has a multi-step speed operation function that can set many frequency references in advance. Set frequency references in *d1-xx* parameters. You can select the set frequency references with MFDI signals from an external source. Activate and deactivate the digital input to select the frequency reference to change the motor speed in steps. You can use the 16-step frequency reference and one Jog Frequency Reference (JOG command) to switch the speed to the maximum 17-step speeds.

Note:

- The Jog Frequency Reference (JOG command) overrides all other frequency references.
- You can use the MFDI to switch the frequency reference when the motor is running. The drive will apply the enabled acceleration and deceleration times.
- The default settings for Multi-Step Speed Reference 1 (master frequency reference) and Multi-Step Speed Reference 2 (auxiliary frequency reference) are the analog frequency reference.

Also, voltage command input terminal A1 and current input terminal A2 for Multi-Step Speed Reference 1 (master frequency reference) are added internally by default. The drive uses Multi-Step Speed Reference 1 when the signal is connected to an analog input terminal.

■ Setting Procedures for Multi-step Speed Operation

Use an Analog Input as Reference 1 and 2

This section gives information about the procedures to set these examples:

- Multi-Step Speed 6 (6 types of frequency references)
- When you set the voltage input of analog inputs from terminals A1 and A3 to -10 V to +10 V

Procedure	Configuration Parameter	Task Contents
1	Reference 1	<ol style="list-style-type: none"> Set $b1-01 = 1$ [Frequency Reference Selection 1 = Analog Input]. Set $H3-02 = 0$ [Terminal A1 Function Selection = Frequency Reference]. Set $H3-01 = 1$ [Terminal A1 Signal Level Select = -10 to +10V (Bipolar Reference)].
2	Reference 2	<ol style="list-style-type: none"> Set $H3-06 = 2$ [Terminal A3 Function Selection = Auxiliary Frequency Reference 1]. Set $H3-05 = 1$ [Terminal A3 Signal Level Select = -10 to +10V (Bipolar Reference)].
3	Signal type of analog input	Set DIP switches S1-1 and S1-3 on the control circuit board to the V-side (voltage). Note: Set this before you energize the drive.
4	Reference 3	Set the value of $d1-03$ [Reference 3].
5	Reference 4	Set the value of $d1-04$ [Reference 4].
6	Reference 5	Set the value of $d1-05$ [Reference 5].
7	Jog Reference	Set $d1-17$ [Jog Reference] to the jog speed.
8	External digital input (3 inputs)	Set the Multi-Step Speed Reference 1 to 3 [$H1-xx = 3, 4, 5$] to one of the MFDI terminals S1 to S8.
9	JOG command	Set the Jog Reference Selection [$H1-xx = 6$] to one of the MFDI terminals S1 to S8.

Use the Maximum 17-Step Speed with All Digital Inputs

This section is the procedure to set the 17-step speeds (17 types of frequency references) without an analog input.

Procedure	Configuration Parameter	Task Contents
1	Reference 1	<ol style="list-style-type: none"> Set $b1-01 = 0$ [Frequency Reference Selection 1 = Keypad]. Set the value of $d1-01$ [Reference 1].
2	Reference 2	<ol style="list-style-type: none"> Set $H3-06 = F$ [Terminal A3 Function Selection = Not Used], and disables the analog reference. Set the value of $d1-02$ [Reference 2].
3	Reference 3	<ol style="list-style-type: none"> Set $H3-10 = F$ [Terminal A2 Function Selection = Not Used], and disables the analog reference. Set the value of $d1-03$ [Reference 3].
4	Reference 4	Set the value of $d1-04$ [Reference 4].
5	Reference 5 to 16	Sets the values of $d1-05$ to $d1-16$ [Reference 5 to 16].
6	Jog Reference	Set $d1-17$ [Jog Reference] to the jog speed.
7	External digital input (4 inputs)	Set Multi-Step Speed Reference 1 to 4 [$H1-xx = 3, 4, 5, 32$] to one of the MFDI terminals S1 to S8.
8	JOG command	Set the Jog Reference Selection [$H1-xx = 6$] to one of the MFDI terminals S1 to S8.

Multi-step Speed Operation Combinations

Refer to [Table 12.37](#) and [Figure 12.60](#) for information about multi-step speed reference combinations. The selected frequency reference changes when the combination of digital input signals from an external source changes.

Table 12.37 Multi-step Speed Reference and MFDI Terminal Combinations

Related Parameters	Multi-Step Speed Reference 1 $H1-xx = 3$	Multi-Step Speed Reference 2 $H1-xx = 4$	Multi-Step Speed Reference 3 $H1-xx = 5$	Multi-Step Speed Reference 4 $H1-xx = 32$	Jog Reference $H1-xx = 6$
Reference 1 (set in $b1-01$)	OFF	OFF	OFF	OFF	OFF
Reference 2 ($d1-02$ or terminals A1, A2, A3)	ON	OFF	OFF	OFF	OFF
Reference 3 ($d1-03$ or terminals A1, A2, A3)	OFF	ON	OFF	OFF	OFF
Reference 4 ($d1-04$)	ON	ON	OFF	OFF	OFF
Reference 5 ($d1-05$)	OFF	OFF	ON	OFF	OFF
Reference 6 ($d1-06$)	ON	OFF	ON	OFF	OFF
Reference 7 ($d1-07$)	OFF	ON	ON	OFF	OFF
Reference 8 ($d1-08$)	ON	ON	ON	OFF	OFF
Reference 9 ($d1-09$)	OFF	OFF	OFF	ON	OFF
Reference 10 ($d1-10$)	ON	OFF	OFF	ON	OFF

Related Parameters	Multi-Step Speed Reference 1 H1-xx = 3	Multi-Step Speed Reference 2 H1-xx = 4	Multi-Step Speed Reference 3 H1-xx = 5	Multi-Step Speed Reference 4 H1-xx = 32	Jog Reference H1-xx = 6
Reference 11 (d1-11)	OFF	ON	OFF	ON	OFF
Reference 12 (d1-12)	ON	ON	OFF	ON	OFF
Reference 13 (d1-13)	OFF	OFF	ON	ON	OFF
Reference 14 (d1-14)	ON	OFF	ON	ON	OFF
Reference 15 (d1-15)	OFF	ON	ON	ON	OFF
Reference 16 (d1-16)	ON	ON	ON	ON	OFF
Jog Reference (d1-17) *1	-	-	-	-	ON

*1 The Jog Frequency Reference (JOG command) overrides all other frequency references.

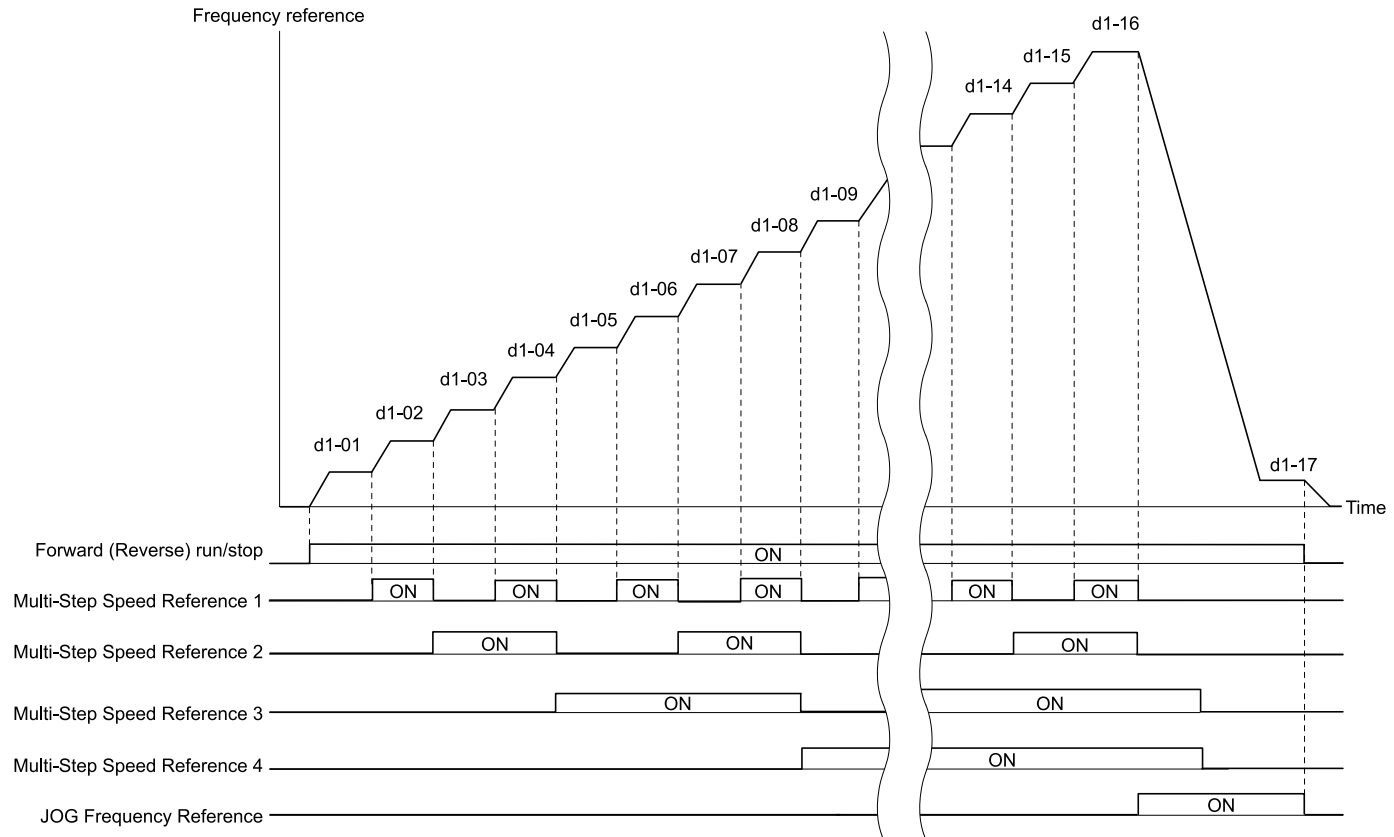

Figure 12.60 Time Chart for Multi-step Speed Reference/JOG Reference

■ d1-01: Reference 1

No. (Hex.)	Name	Description	Default (Range)
d1-01 (0280) RUN	Reference 1	<p>V/f CL-V/f OLV CLV AQLV QLV/PM AQLV/PM CLV/PM EZOLV</p> <p>Sets the frequency reference in the units from o1-03 [Frequency Display Unit Selection].</p>	0.00 Hz (0.00 - 590.00 Hz)

Note:

- The upper limit value changes when the E1-04 [Maximum Output Frequency] and d2-01 [Frequency Reference Upper Limit] values change. Calculate the upper limit value with this formula:
Upper limit value = (E1-04) × (d2-01) / 100
- When A1-02 = 6, 7 [Control Method Selection = AQLV/PM, CLV/PM], the drive changes o1-03 = 1 [0.01% (100% = E1-04)].
- To set d1-01 to 1-step speed parameter in a multi-step speed operation, set b1-01 = 0 [Frequency Reference Selection 1 = Keypad].

■ d1-02: Reference 2

No. (Hex.)	Name	Description	Default (Range)
d1-02 (0281) RUN	Reference 2	<div style="display: flex; justify-content: space-between; align-items: center;"> V/f CL-V/f OLV CLV AOLV OLV/PM AOLV/PM CLV/PM EZOLV </div> Sets the frequency reference in the units from o1-03 [Frequency Display Unit Selection].	0.00 Hz (0.00 - 590.00 Hz)

Note:

- The upper limit value changes when the E1-04 [Maximum Output Frequency] and d2-01 [Frequency Reference Upper Limit] values change.
- When A1-02 = 6, 7 [Control Method Selection = AOLV/PM, CLV/PM], the drive changes o1-03 = 1 [0.01% (100% = E1-04)].
- To set d1-02 to Multi-Step Speed 2, set H3-02, H3-06, and H3-10 ≠ 2 [MFAI Function Select ≠ Auxiliary Frequency Reference 1]. When the status is the default setting, set H3-06 = F [Terminal A3 Function Selection = Not Used].

■ d1-03: Reference 3

No. (Hex.)	Name	Description	Default (Range)
d1-03 (0282) RUN	Reference 3	<div style="display: flex; justify-content: space-between; align-items: center;"> V/f CL-V/f OLV CLV AOLV OLV/PM AOLV/PM CLV/PM EZOLV </div> Sets the frequency reference in the units from o1-03 [Frequency Display Unit Selection].	0.00 Hz (0.00 - 590.00 Hz)

Note:

- The upper limit value changes when the E1-04 [Maximum Output Frequency] and d2-01 [Frequency Reference Upper Limit] values change.
- When A1-02 = 6, 7 [Control Method Selection = AOLV/PM, CLV/PM], the drive changes o1-03 = 1 [0.01% (100% = E1-04)].
- To set d1-03 to Multi-Step Speed 3, set H3-02, H3-06, and H3-10 ≠ 3 [MFAI Function Select ≠ Auxiliary Frequency Reference 2].

■ d1-04: Reference 4

No. (Hex.)	Name	Description	Default (Range)
d1-04 (0283) RUN	Reference 4	<div style="display: flex; justify-content: space-between; align-items: center;"> V/f CL-V/f OLV CLV AOLV OLV/PM AOLV/PM CLV/PM EZOLV </div> Sets the frequency reference in the units from o1-03 [Frequency Display Unit Selection].	0.00 Hz (0.00 - 590.00 Hz)

Note:

- The upper limit value changes when the E1-04 [Maximum Output Frequency] and d2-01 [Frequency Reference Upper Limit] values change.
- When A1-02 = 6, 7 [Control Method Selection = AOLV/PM, CLV/PM], the drive changes o1-03 = 1 [0.01% (100% = E1-04)].
- This parameter sets the frequency reference of Multi-Step Speed 4.

■ d1-05: Reference 5

No. (Hex.)	Name	Description	Default (Range)
d1-05 (0284) RUN	Reference 5	<div style="display: flex; justify-content: space-between; align-items: center;"> V/f CL-V/f OLV CLV AOLV OLV/PM AOLV/PM CLV/PM EZOLV </div> Sets the frequency reference in the units from o1-03 [Frequency Display Unit Selection].	0.00 Hz (0.00 - 590.00 Hz)

Note:

- The upper limit value changes when the E1-04 [Maximum Output Frequency] and d2-01 [Frequency Reference Upper Limit] values change.
- When A1-02 = 6, 7 [Control Method Selection = AOLV/PM, CLV/PM], the drive changes o1-03 = 1 [0.01% (100% = E1-04)].
- This parameter sets the frequency reference of Multi-Step Speed 5.

■ d1-06: Reference 6

No. (Hex.)	Name	Description	Default (Range)
d1-06 (0285) RUN	Reference 6	<div style="display: flex; justify-content: space-between; align-items: center;"> V/f CL-V/f OLV CLV AOLV OLV/PM AOLV/PM CLV/PM EZOLV </div> Sets the frequency reference in the units from o1-03 [Frequency Display Unit Selection].	0.00 Hz (0.00 - 590.00 Hz)

Note:

- The upper limit value changes when the *E1-04* [Maximum Output Frequency] and *d2-01* [Frequency Reference Upper Limit] values change.
- When *A1-02* = 6, 7 [Control Method Selection = AOLV/PM, CLV/PM], the drive changes *o1-03* = 1 [0.01% (100% = *E1-04*)].
- This parameter sets the frequency reference of Multi-Step Speed 6.

■ **d1-07: Reference 7**

No. (Hex.)	Name	Description	Default (Range)
d1-07 (0286) RUN	Reference 7	<div style="display: flex; justify-content: space-between; font-size: 0.8em; font-weight: bold;"> V/f CL-V/f OLV CLV AOLV OLV/PM AOLV/PM CLV/PM EZOLV </div> Sets the frequency reference in the units from <i>o1-03</i> [Frequency Display Unit Selection].	0.00 Hz (0.00 - 590.00 Hz)

Note:

- The upper limit value changes when the *E1-04* [Maximum Output Frequency] and *d2-01* [Frequency Reference Upper Limit] values change.
- When *A1-02* = 6, 7 [Control Method Selection = AOLV/PM, CLV/PM], the drive changes *o1-03* = 1 [0.01% (100% = *E1-04*)].
- This parameter sets the frequency reference of Multi-Step Speed 7.

■ **d1-08: Reference 8**

No. (Hex.)	Name	Description	Default (Range)
d1-08 (0287) RUN	Reference 8	<div style="display: flex; justify-content: space-between; font-size: 0.8em; font-weight: bold;"> V/f CL-V/f OLV CLV AOLV OLV/PM AOLV/PM CLV/PM EZOLV </div> Sets the frequency reference in the units from <i>o1-03</i> [Frequency Display Unit Selection].	0.00 Hz (0.00 - 590.00 Hz)

Note:

- The upper limit value changes when the *E1-04* [Maximum Output Frequency] and *d2-01* [Frequency Reference Upper Limit] values change.
- When *A1-02* = 6, 7 [Control Method Selection = AOLV/PM, CLV/PM], the drive changes *o1-03* = 1 [0.01% (100% = *E1-04*)].
- This parameter sets the frequency reference of Multi-Step Speed 8.

■ **d1-09: Reference 9**

No. (Hex.)	Name	Description	Default (Range)
d1-09 (0288) RUN	Reference 9	<div style="display: flex; justify-content: space-between; font-size: 0.8em; font-weight: bold;"> V/f CL-V/f OLV CLV AOLV OLV/PM AOLV/PM CLV/PM EZOLV </div> Sets the frequency reference in the units from <i>o1-03</i> [Frequency Display Unit Selection].	0.00 Hz (0.00 - 590.00 Hz)

Note:

- The upper limit value changes when the *E1-04* [Maximum Output Frequency] and *d2-01* [Frequency Reference Upper Limit] values change.
- When *A1-02* = 6, 7 [Control Method Selection = AOLV/PM, CLV/PM], the drive changes *o1-03* = 1 [0.01% (100% = *E1-04*)].
- This parameter sets the frequency reference of Multi-Step Speed 9.

■ **d1-10: Reference 10**

No. (Hex.)	Name	Description	Default (Range)
d1-10 (028B) RUN	Reference 10	<div style="display: flex; justify-content: space-between; font-size: 0.8em; font-weight: bold;"> V/f CL-V/f OLV CLV AOLV OLV/PM AOLV/PM CLV/PM EZOLV </div> Sets the frequency reference in the units from <i>o1-03</i> [Frequency Display Unit Selection].	0.00 Hz (0.00 - 590.00 Hz)

Note:

- The upper limit value changes when the *E1-04* [Maximum Output Frequency] and *d2-01* [Frequency Reference Upper Limit] values change.
- When *A1-02* = 6, 7 [Control Method Selection = AOLV/PM, CLV/PM], the drive changes *o1-03* = 1 [0.01% (100% = *E1-04*)].
- This parameter sets the frequency reference of Multi-Step Speed 10.

■ d1-11: Reference 11

No. (Hex.)	Name	Description	Default (Range)
d1-11 (028C) RUN	Reference 11	<div style="display: flex; justify-content: space-between; font-size: 0.8em; font-weight: bold; background-color: #f0f0f0; padding: 2px;"> V/f CL-V/f OLV CLV AOLV OLV/PM AOLV/PM CLV/PM EZOLV </div> Sets the frequency reference in the units from o1-03 [Frequency Display Unit Selection].	0.00 Hz (0.00 - 590.00 Hz)

Note:

- The upper limit value changes when the E1-04 [Maximum Output Frequency] and d2-01 [Frequency Reference Upper Limit] values change.
- When A1-02 = 6, 7 [Control Method Selection = AOLV/PM, CLV/PM], the drive changes o1-03 = 1 [0.01% (100% = E1-04)].
- This parameter sets the frequency reference of Multi-Step Speed 11.

■ d1-12: Reference 12

No. (Hex.)	Name	Description	Default (Range)
d1-12 (028D) RUN	Reference 12	<div style="display: flex; justify-content: space-between; font-size: 0.8em; font-weight: bold; background-color: #f0f0f0; padding: 2px;"> V/f CL-V/f OLV CLV AOLV OLV/PM AOLV/PM CLV/PM EZOLV </div> Sets the frequency reference in the units from o1-03 [Frequency Display Unit Selection].	0.00 Hz (0.00 - 590.00 Hz)

Note:

- The upper limit value changes when the E1-04 [Maximum Output Frequency] and d2-01 [Frequency Reference Upper Limit] values change.
- When A1-02 = 6, 7 [Control Method Selection = AOLV/PM, CLV/PM], the drive changes o1-03 = 1 [0.01% (100% = E1-04)].
- This parameter sets the frequency reference of Multi-Step Speed 12.

■ d1-13: Reference 13

No. (Hex.)	Name	Description	Default (Range)
d1-13 (028E) RUN	Reference 13	<div style="display: flex; justify-content: space-between; font-size: 0.8em; font-weight: bold; background-color: #f0f0f0; padding: 2px;"> V/f CL-V/f OLV CLV AOLV OLV/PM AOLV/PM CLV/PM EZOLV </div> Sets the frequency reference in the units from o1-03 [Frequency Display Unit Selection].	0.00 Hz (0.00 - 590.00 Hz)

Note:

- The upper limit value changes when the E1-04 [Maximum Output Frequency] and d2-01 [Frequency Reference Upper Limit] values change.
- When A1-02 = 6, 7 [Control Method Selection = AOLV/PM, CLV/PM], the drive changes o1-03 = 1 [0.01% (100% = E1-04)].
- This parameter sets the frequency reference of Multi-Step Speed 13.

■ d1-14: Reference 14

No. (Hex.)	Name	Description	Default (Range)
d1-14 (028F) RUN	Reference 14	<div style="display: flex; justify-content: space-between; font-size: 0.8em; font-weight: bold; background-color: #f0f0f0; padding: 2px;"> V/f CL-V/f OLV CLV AOLV OLV/PM AOLV/PM CLV/PM EZOLV </div> Sets the frequency reference in the units from o1-03 [Frequency Display Unit Selection].	0.00 Hz (0.00 - 590.00 Hz)

Note:

- The upper limit value changes when the E1-04 [Maximum Output Frequency] and d2-01 [Frequency Reference Upper Limit] values change.
- When A1-02 = 6, 7 [Control Method Selection = AOLV/PM, CLV/PM], the drive changes o1-03 = 1 [0.01% (100% = E1-04)].
- This parameter sets the frequency reference of Multi-Step Speed 14.

■ d1-15: Reference 15

No. (Hex.)	Name	Description	Default (Range)
d1-15 (0290) RUN	Reference 15	<div style="display: flex; justify-content: space-between; font-size: 0.8em; font-weight: bold; background-color: #f0f0f0; padding: 2px;"> V/f CL-V/f OLV CLV AOLV OLV/PM AOLV/PM CLV/PM EZOLV </div> Sets the frequency reference in the units from o1-03 [Frequency Display Unit Selection].	0.00 Hz (0.00 - 590.00 Hz)

Note:

- The upper limit value changes when the *E1-04* [Maximum Output Frequency] and *d2-01* [Frequency Reference Upper Limit] values change.
- When *A1-02* = 6, 7 [Control Method Selection = AOLV/PM, CLV/PM], the drive changes *o1-03* = 1 [0.01% (100% = *E1-04*)].
- This parameter sets the frequency reference of Multi-Step Speed 15.

■ **d1-16: Reference 16**

No. (Hex.)	Name	Description	Default (Range)
d1-16 (0291) RUN	Reference 16	<div style="display: flex; justify-content: space-between; font-size: 0.8em; font-weight: bold; background-color: #333; color: white; padding: 2px;"> V/f CL-V/f OLV CLV AOLV OLV/PM AOLV/PM CLV/PM EZOLV </div> Sets the frequency reference in the units from <i>o1-03</i> [Frequency Display Unit Selection].	0.00 Hz (0.00 - 590.00 Hz)

Note:

- The upper limit value changes when the *E1-04* [Maximum Output Frequency] and *d2-01* [Frequency Reference Upper Limit] values change.
- When *A1-02* = 6, 7 [Control Method Selection = AOLV/PM, CLV/PM], the drive changes *o1-03* = 1 [0.01% (100% = *E1-04*)].
- This parameter sets the frequency reference of Multi-Step Speed 16.

■ **d1-17: Jog Reference**

No. (Hex.)	Name	Description	Default (Range)
d1-17 (0292) RUN	Jog Reference	<div style="display: flex; justify-content: space-between; font-size: 0.8em; font-weight: bold; background-color: #333; color: white; padding: 2px;"> V/f CL-V/f OLV CLV AOLV OLV/PM AOLV/PM CLV/PM EZOLV </div> Sets the Jog frequency reference in the units from <i>o1-03</i> [Frequency Display Unit Selection]. Set <i>H1-xx</i> = 6 [MFDI Function Select = Jog Reference Selection] to use the Jog frequency reference.	6.00 Hz (0.00 - 590.00 Hz)

Note:

- The upper limit value changes when the *E1-04* [Maximum Output Frequency] and *d2-01* [Frequency Reference Upper Limit] values change.
- When *A1-02* = 6, 7 [Control Method Selection = AOLV/PM, CLV/PM], the drive changes *o1-03* = 1 [0.01% (100% = *E1-04*)].

◆ **d2: Reference Limits**

d2 parameters set the upper and lower frequency limits to control the motor speed. Apply these parameters to for example, run the motor at low-speed due to mechanical strength concerns, or if the motor should not be run at low speed because of lubrication issues with the gears and bearings.

The upper frequency limit is set in *d2-01* [Frequency Reference Upper Limit] and the lower limit is set in *d2-02* [Frequency Reference Lower Limit].

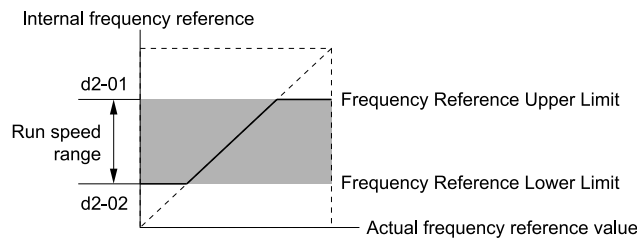

Figure 12.61 Upper and Lower Frequency Limits

■ **d2-01: Frequency Reference Upper Limit**

No. (Hex.)	Name	Description	Default (Range)
d2-01 (0289)	Frequency Reference Upper Limit	<div style="display: flex; justify-content: space-between; font-size: 0.8em; font-weight: bold; background-color: #333; color: white; padding: 2px;"> V/f CL-V/f OLV CLV AOLV OLV/PM AOLV/PM CLV/PM EZOLV </div> Sets maximum limit for all frequency references. The maximum output frequency is 100%.	100.0% (0.0 - 110.0%)

When the frequency reference is more than the value set in *d2-01* the drive will continue to operate at the value set in *d2-01*.

■ d2-02: Frequency Reference Lower Limit

No. (Hex.)	Name	Description	Default (Range)
d2-02 (028A)	Frequency Reference Lower Limit	V/f CL-V/f OLV CLV AOLV OLV/PM AOLV/PM CLV/PM EZOLV Sets minimum limit for all frequency references. The maximum output frequency is 100%.	0.0% (0.0 - 110.0%)

When the frequency reference is less than the value set in *d2-02*, the drive will continue to operate at the value set in *d2-02*. The motor will accelerate to the *d2-02* value after the drive receives a Run command and a lower frequency reference than *d2-02* has been entered.

■ d2-03: Analog Frequency Ref Lower Limit

No. (Hex.)	Name	Description	Default (Range)
d2-03 (0293)	Analog Frequency Ref Lower Limit	V/f CL-V/f OLV CLV AOLV OLV/PM AOLV/PM CLV/PM EZOLV Sets the lower limit for the master frequency reference (the first frequency of the multi-step speed reference) as a percentage. The maximum output frequency is 100%.	0.0% (0.0 - 110.0%)

This parameter does not change the lower limit of Jog reference, frequency reference for multi-step speed operation, or the auxiliary frequency reference.

The drive operates at the value set in *d2-03* when the frequency reference decreases to less than the value set in *d2-03*.

Note:

When lower limits are set to parameters *d2-02* [Frequency Reference Lower Limit] and *d2-03*, the drive uses the larger value as the lower limit.

◆ d3: Jump Frequency

The Jump frequency is a function that sets the dead band to a specified frequency band. If a machine that operated at constant speed is operated with variable speed, it can make resonance. To operate the machine without resonance from the natural frequency of the machinery mechanical system, use a frequency band jump.

You can program the drive to have three different Jump frequencies. Set *d3-01* to *d3-03* [Jump Frequencies] to the median value for the jumped frequency and set *d3-04* [Jump Frequency Width] to the Jump frequency width.

When you input a frequency reference that is the same as or near the Jump frequency width, the frequency reference changes automatically.

The drive accelerates or decelerates the motor smoothly until the frequency reference is not in the range of the Jump frequency band. The drive will use the active accel/decel time to go through the specified dead band range. If the frequency reference is not in the range of the Jump frequency band, switch to constant speed operation.

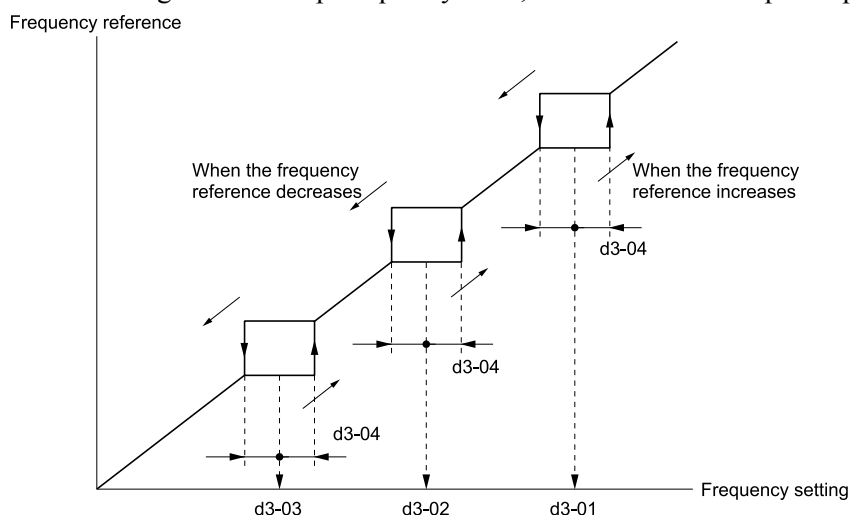

Figure 12.62 Jump Frequency

Note:

- When you set Jump Frequencies 1 to 3, make sure that the parameters do not overlap.
- When the drive is in the range of the Jump frequency, the frequency reference changes automatically. When Jump is executed, the output frequency changes smoothly as specified by the values set in *C1-01 [Acceleration Time 1]* and *C1-02 [Deceleration Time 1]*.

■ **d3-01: Jump Frequency 1**

No. (Hex.)	Name	Description	Default (Range)
d3-01 (0294)	Jump Frequency 1	<div style="display: flex; justify-content: space-between; gap: 5px;"> V/f CL-V/f OLV CLV AOLV OLV/PM AOLV/PM CLV/PM EZOLV </div> Sets the median value of the frequency band that the drive will avoid.	0.0 Hz (Determined by A1-02)

Note:

Set this parameter to 0.0 Hz to disable the Jump frequency.

■ **d3-02: Jump Frequency 2**

No. (Hex.)	Name	Description	Default (Range)
d3-02 (0295)	Jump Frequency 2	<div style="display: flex; justify-content: space-between; gap: 5px;"> V/f CL-V/f OLV CLV AOLV OLV/PM AOLV/PM CLV/PM EZOLV </div> Sets the median value of the frequency band that the drive will avoid.	0.0 Hz (Determined by A1-02)

Note:

Set this parameter to 0.0 Hz to disable the Jump frequency.

■ **d3-03: Jump Frequency 3**

No. (Hex.)	Name	Description	Default (Range)
d3-03 (0296)	Jump Frequency 3	<div style="display: flex; justify-content: space-between; gap: 5px;"> V/f CL-V/f OLV CLV AOLV OLV/PM AOLV/PM CLV/PM EZOLV </div> Sets the median value of the frequency band that the drive will avoid.	0.0 Hz (Determined by A1-02)

Note:

Set this parameter to 0.0 Hz to disable the Jump frequency.

■ **d3-04: Jump Frequency Width**

No. (Hex.)	Name	Description	Default (Range)
d3-04 (0297)	Jump Frequency Width	<div style="display: flex; justify-content: space-between; gap: 5px;"> V/f CL-V/f OLV CLV AOLV OLV/PM AOLV/PM CLV/PM EZOLV </div> Sets the width of the frequency band that the drive will avoid.	1.0 Hz (Determined by A1-02)

◆ **d4: Frequency Ref Up/Down & Hold**

The *d4 parameters* set the Frequency Reference Hold function and Up/Down and Up/Down 2 commands.

- Frequency Reference Hold Function Command: This acceleration/deceleration ramp hold command uses an MFDI to momentarily stop the acceleration/deceleration of the motor, and continues to operate the motor at the output frequency at which the command reference was input. Turn OFF the acceleration/deceleration ramp hold command to continue acceleration/deceleration.
- Up/Down command: The Up/Down command is a function to activate and deactivate an MFDI to increase and decrease the frequency reference. The Up/Down command overrides frequency references from the analog input terminal, pulse train input terminal, and keypad.
- Up/Down 2 command: The Up/Down 2 command is a function that adds a set bias value to the frequency reference to accelerate or decelerate. The Up/Down 2 command activates and deactivates the MFDI to add a bias value.

■ **d4-01: Freq Reference Hold Selection**

No. (Hex.)	Name	Description	Default (Range)
d4-01 (0298)	Freq Reference Hold Selection	<div style="display: flex; justify-content: space-between; gap: 5px;"> V/f CL-V/f OLV CLV AOLV OLV/PM AOLV/PM CLV/PM EZOLV </div> Sets the function that saves the frequency reference or the frequency bias (Up/Down 2) after a Stop command or when de-energizing the drive.	0 (0, 1)

Set $H1-xx$ [MFDI Function Selection] to one of these values to enable this parameter:

- A [Accel/Decel Ramp Hold]
- $10/11$ [Up/Down Command]
- $75/76$ [Up/Down 2 Command]

0 : Disabled

- Acceleration/Deceleration Ramp Hold
When you enter a Stop command or de-energize the drive, the hold value is reset to 0 Hz. The drive will use the active frequency reference when it restarts.
- Up/Down Command
When you enter a Stop command or de-energize the drive, the frequency reference value is reset to 0 Hz. The drive will start from 0 Hz when it restarts.
- Up/Down 2 Command
When you enter the Stop command or 5 s after you release the Up/Down 2 command, the drive does not save the frequency bias. The Up/Down 2 function will start with a bias of 0% when the drive restarts.

1 : Enabled

- Acceleration/Deceleration Ramp Hold
When you clear the Run command or de-energize the drive, it will save the last hold value. The drive will use the saved value as the frequency reference when it restarts.

Note:

When you energize the drive, continuously enable the MFDI terminal set for *Accel/Decel Ramp Hold* [$H1-xx = A$]. If the digital input does not activate, the drive will clear the hold value and set it to 0 Hz.

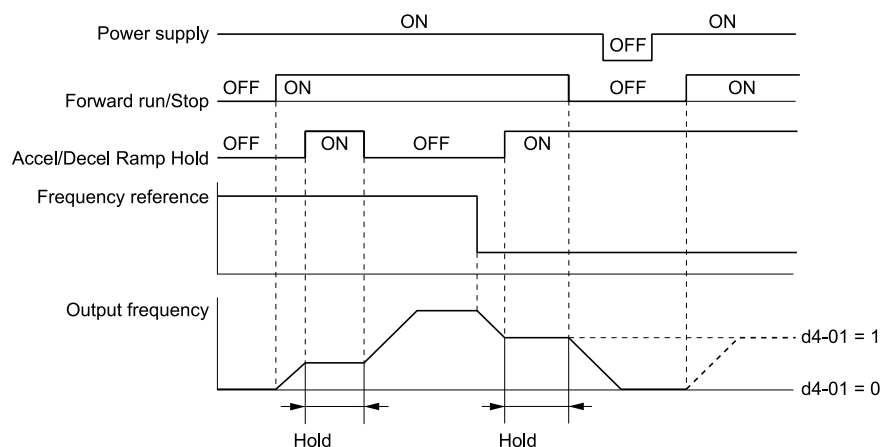

Figure 12.63 Frequency Reference Hold with Accel/Decel Hold Function

- Up/Down Command
When you clear the Run command or de-energize the drive, it will save the frequency reference value. The drive will use the saved value as the frequency reference when it restarts.
- Up/Down 2 Command with Frequency Reference from Keypad
When a Run command is active and you release the Up/Down 2 command for longer than 5 s, the drive adds the Up/Down 2 bias value to the frequency reference and sets it to 0. The drive saves the frequency reference value to which the bias value was added. The drive will use the new value as the frequency reference when it restarts.

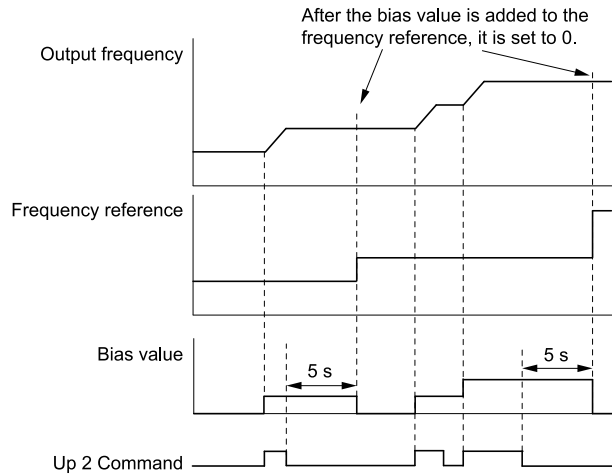

Figure 12.64 Up/Down 2 Example with Reference from Keypad and d4-01 = 1

- Up/Down 2 Command with Frequency Reference from Input Sources Other Than the Keypad
When a Run command is active and you release the Up/Down 2 command for longer than 5 s, the drive will save the bias value in d4-06 [Frequency Ref Bias (Up/Down 2)]. The drive saves the frequency reference + d4-06 as a frequency reference value. The drive will use the new value as the frequency reference when it restarts.

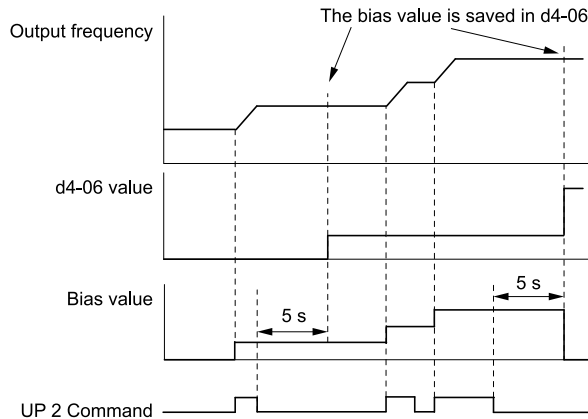

Figure 12.65 Up/Down 2 Example with Other Reference than Keypad and d4-01 = 1

Note:

To use the combination of the frequency reference hold function and the Up/Down 2 function, configure the Up/Down 2 upper limit [d4-08] and lower limit [d4-09] correctly.

Remove the Saved Frequency Reference Value

The procedure to remove the saved frequency reference value is different for different functions. Use these methods to remove the value:

- Release the input programmed for *Accel/Decel Ramp Hold* [H1-xx = A].
- Set an Up or Down command while no Run command is active.
- Use the Up/Down 2 Command to set d4-06 = 0.0 or set d4-06 = 0.0 during stop.

■ **d4-03: Up/Down 2 Bias Step Frequency**

No. (Hex.)	Name	Description	Default (Range)
d4-03 (02AA) RUN	Up/Down 2 Bias Step Frequency	V/f CL-V/f OLV CLV AOLV OLV/PM AOLV/PM CLV/PM EZOLV Sets the bias that the Up/Down 2 function adds to or subtracts from the frequency reference.	0.00 Hz (0.00 - 99.99 Hz)

The operation is different for different setting values:

- **Setting d4-03 = 0.00 Hz**

When the *Up/Down 2 Command* [$H1-xx = 75, 76$] is active, the drive uses the accel/decel times set in $d4-04$ [*Up/Down 2 Ramp Selection*] to increase or decrease the bias value.

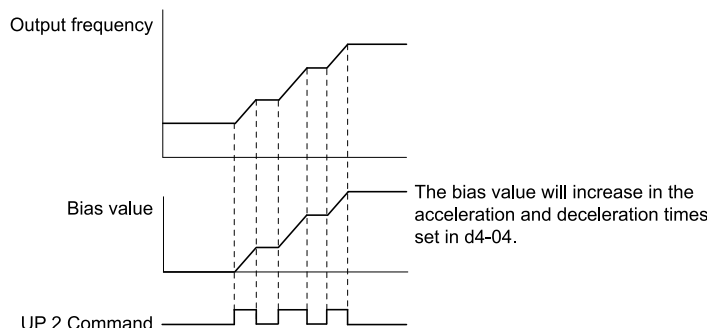

Figure 12.66 Up/Down 2 Bias when $d4-03 = 0.00$ Hz

- **Setting $d4-03 \neq 0.00$ Hz**

When the *Up/Down 2 Command* [$H1-xx = 75, 76$] is active, the drive increases or decreases the bias in steps for the value set in $d4-03$. The drive uses the acceleration and deceleration times set in $d4-04$.

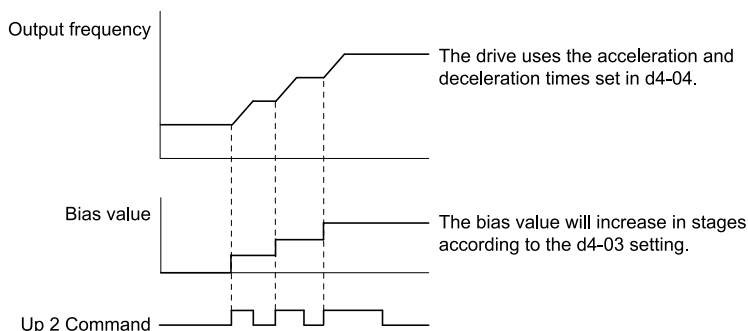

Figure 12.67 Up/Down 2 Bias when $d4-03 \neq 0.00$ Hz

■ $d4-04$: Up/Down 2 Ramp Selection

No. (Hex.)	Name	Description	Default (Range)
$d4-04$ (02AB) RUN	Up/Down 2 Ramp Selection	<input type="checkbox"/> V/f <input type="checkbox"/> CL-V/f <input type="checkbox"/> OLV <input type="checkbox"/> CLV <input type="checkbox"/> AOLV <input type="checkbox"/> OLV/PM <input type="checkbox"/> AOLV/PM <input type="checkbox"/> CLV/PM <input type="checkbox"/> EZOLV Sets the acceleration and deceleration times for the Up/Down 2 function to apply the bias to the frequency reference.	0 (0, 1)

0 : Use Selected Accel/Decel Time

Use the active acceleration and deceleration times to increase or decrease the bias.

1 : Use Accel/Decel Time 4

Use $C1-07$ [*Acceleration Time 4*] and $C1-08$ [*Deceleration Time 4*] to increase or decrease the bias.

■ $d4-05$: Up/Down 2 Bias Mode Selection

No. (Hex.)	Name	Description	Default (Range)
$d4-05$ (02AC) RUN	Up/Down 2 Bias Mode Selection	<input type="checkbox"/> V/f <input type="checkbox"/> CL-V/f <input type="checkbox"/> OLV <input type="checkbox"/> CLV <input type="checkbox"/> AOLV <input type="checkbox"/> OLV/PM <input type="checkbox"/> AOLV/PM <input type="checkbox"/> CLV/PM <input type="checkbox"/> EZOLV Sets the function that saves the bias value to the drive when you open or close the two <i>Up/Down 2 Commands</i> [$H1-xx = 75, 76$]. Set $d4-03$ [<i>Up/Down 2 Bias Step Frequency</i>] = 0.00 before you set this parameter.	0 (0, 1)

0 : Hold when Neither Up/Down Closed

When the two MFDI terminals set for *Up/Down 2 Command* [$H1-xx = 75, 76$] activate or deactivate, the drive will hold the bias value.

1 : Reset when Neither / Both Closed

When the two MFDI terminals set for *Up/Down 2 Command* [$H1-xx = 75, 76$] activate or deactivate, the drive will reset the bias value to 0. The drive will use the acceleration and deceleration times set in $d4-04$ [*Up/Down 2 Ramp Selection*] to accelerate and decelerate the motor to the selected output frequency.

■ d4-06: Frequency Ref Bias (Up/Down 2)

No. (Hex.)	Name	Description	Default (Range)
d4-06 (02AD)	Frequency Ref Bias (Up/Down 2)	<div style="display: flex; justify-content: space-between; font-size: 0.8em; font-weight: bold;"> V/f CL-V/f OLV CLV AOLV OLV/PM AOLV/PM CLV/PM EZOLV </div> Saves the bias value from the Up/Down 2 Command where the Maximum Output Frequency is 100%.	0.0% (-99.9 - +100.0%)

The Up/Down 2 function setting changes the function of *d4-06*:

Note:

When the keypad sets the frequency reference, you do not usually use parameter *d4-06*.

- When *d4-01 = 0* [*Freq Reference Hold Selection = Disabled*] and a source other than the keypad sets the frequency reference, the drive adds the value set in *d4-06* to the frequency reference. If the value set in *d4-06* is a negative number, the drive will subtract it from frequency reference.
- When *d4-01 = 1* [*Enabled*] and a source other than the keypad sets the frequency reference, the drive will store the bias value adjusted with the Up/Down 2 command in *d4-06* 5 seconds after you release the Up/Down 2 command. The drive adds or subtracts the value set in *d4-06* to the frequency reference.

Conditions that Reset or Disable d4-06

The drive resets and disables the bias value in these conditions:

- *d4-01 = 0* and the Run command was cleared.
- *H1-xx = 75, 76* [*MFDI Function Select = Up/Down 2 Command*] is not set.
- The frequency reference source was changed.
This includes switching LOCAL/REMOTE and multi-step speed reference.
- A digital input changed the frequency reference value.
- *d4-03* [*Up/Down 2 Bias Step Frequency*] = 0 and *d4-05 = 1* [*Up/Down 2 Bias Mode Selection = Reset when Neither / Both Closed*], and the two MFDI terminals set for *Up/Down 2 Command* [*H1-xx = 75/76*] are activated or deactivated.
- The value of *E1-04* [*Maximum Output Frequency*] was changed.

■ d4-07: Analog Freq Ref Fluctuate Limit

No. (Hex.)	Name	Description	Default (Range)
d4-07 (02AE) RUN	Analog Freq Ref Fluctuate Limit	<div style="display: flex; justify-content: space-between; font-size: 0.8em; font-weight: bold;"> V/f CL-V/f OLV CLV AOLV OLV/PM AOLV/PM CLV/PM EZOLV </div> If the frequency reference changes for more than the level set to this parameter, then the bias value will be held. The value is set as a percentage of the Maximum Output Frequency.	1.0% (0.1 - 100.0%)

Handles frequency reference changes while *Up/Down 2 Command* [*H1-xx = 75, 76*] is activated. When the frequency reference changes for more than the level set in *d4-07*, the drive will hold the bias value, and the drive will accelerate or decelerate to the frequency reference. When the drive is at the frequency reference, it releases the bias hold and the bias follows the Up/Down 2 input commands.

This parameter is applicable only when an analog or pulse input sets the frequency reference.

■ d4-08: Up/Down 2 Bias Upper Limit

No. (Hex.)	Name	Description	Default (Range)
d4-08 (02AF) RUN	Up/Down 2 Bias Upper Limit	<div style="display: flex; justify-content: space-between; font-size: 0.8em; font-weight: bold;"> V/f CL-V/f OLV CLV AOLV OLV/PM AOLV/PM CLV/PM EZOLV </div> Sets the upper limit of the Up/Down 2 bias as a percentage of the Maximum Output Frequency.	100.0% (0.0 - 100.0%)

The drive saves the set bias upper limit in *d4-06* [*Frequency Ref Bias (Up/Down 2)*]. Set *d4-08* an applicable value before you use the Up/Down 2 function.

Note:

When *d4-01 = 1* [*Freq Reference Hold Selection = Enabled*] and *b1-01 = 0* [*Frequency Reference Selection 1 = Keypad*], the drive will add the bias value to the frequency reference when it does not receive an Up/Down 2 command for 5 s. Then the drive will reset the value to 0 at which time you can increase the bias to the limit set in *d4-08* again.

■ d4-09: Up/Down 2 Bias Lower Limit

No. (Hex.)	Name	Description	Default (Range)
d4-09 (02B0) RUN	Up/Down 2 Bias Lower Limit	V/f CL-V/f OLV CLV AOLV OLV/PM AOLV/PM CLV/PM EZOLV Sets the lower limit of the Up/Down 2 bias as a percentage of the Maximum Output Frequency.	0.0% (-99.9 - 0.0%)

The drive saves the set bias lower limit in *d4-06* [*Frequency Ref Bias (Up/Down 2)*]. Set *d4-09* to an applicable value before you use the Up/Down 2 function.

Note:

When *d4-01* = 1 [*Freq Reference Hold Selection = Enabled*] and *b1-01* = 0 [*Frequency Reference Selection 1 = Keypad*], the drive will add the bias value to the frequency reference when it does not receive an Up/Down 2 command for 5 s. Then the drive will reset the value to 0.

If you increase the bias with the Up 2 command and *d4-09* = 0, you cannot use a Down 2 command to decrease the frequency reference. To decrease speed in this condition, set a negative lower limit in *d4-09*.

■ d4-10: Up/Down Freq Lower Limit Select

No. (Hex.)	Name	Description	Default (Range)
d4-10 (02B6)	Up/Down Freq Lower Limit Select	V/f CL-V/f OLV CLV AOLV OLV/PM AOLV/PM CLV/PM EZOLV Sets the lower frequency limit for the Up/Down function.	0 (0, 1)

0 : Greater of d2-02 or Analog

The higher value between *d2-02* [*Frequency Reference Lower Limit*] and an analog input programmed for *Frequency Reference* [*H3-02, H3-06, H3-10* = 0] sets the lower frequency reference limit.

Note:

When you use *External Reference 1/2 Selection* [*H1-xx* = 2] to switch between the Up/Down function and an analog input as the reference source, the analog value becomes the lower reference limit when the Up/Down 2 command is active. Set *d4-10* = 1 to isolate the Up/Down function and the analog input value.

1 : d2-02

You can only use *d2-02* to set the lower limit of the frequency reference.

◆ d5: Torque Control

d5 parameters set the Torque Control function.

The Torque Control function controls the output torque of the motor. You can use Torque Control for roller drives, winders, unwinders, conveyors and other machines that use tension control and push/pull applications. When there is no more material and the machine suddenly has no load, the drive uses Torque Control and the speed limit function to keep the rotation speed of the motor from increasing.

Set *A1-02* [*Control Method Selection*] to one of these values to use Torque Control:

- 3 [Closed Loop Vector]
- 4 [Advanced Open Loop Vector]
- 6 [PM Advanced Open Loop Vector]
- 7 [PM Closed Loop Vector]

Note:

When you use Torque Control and *A1-02* = 4, use a motor designed for winding applications.

Use one of these methods to enable Torque Control:

- Set *d5-01* = 1 [*Torque Control Selection = Torque Control*].
- Set *H1-xx* = 71 [*Torque Control*] ON.

■ Torque Control Operation

Figure 12.68 shows the operation principle of Torque Control.

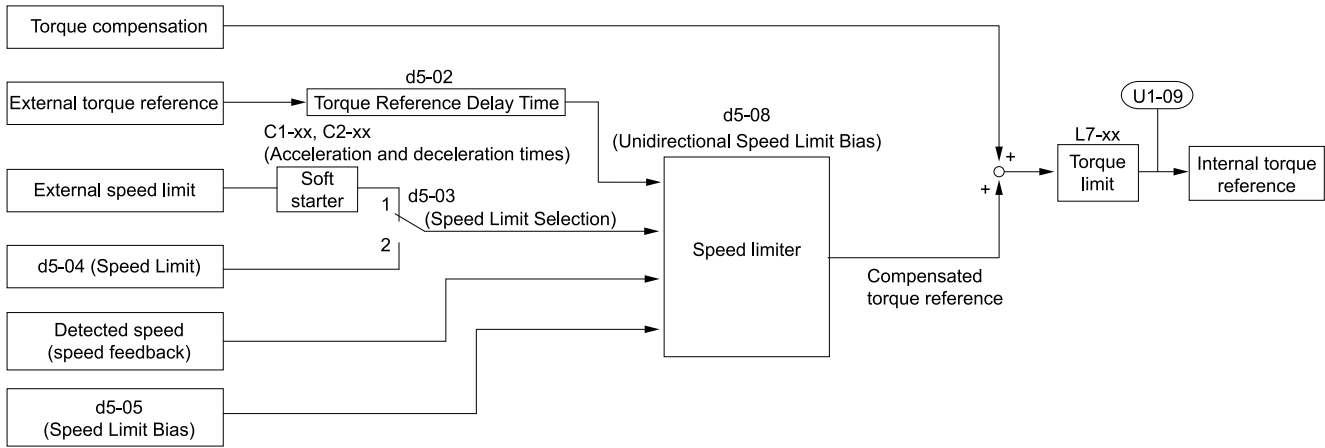

Figure 12.68 Torque Control Block Diagram

The externally input torque reference is the target value for the motor output torque. If the motor output torque and load torque are not balanced during Torque Control, the motor accelerates or decelerates. To prevent operation beyond the speed limit, the drive corrects the external torque reference if the motor speed reaches the speed limit. The speed limit, speed feedback, and the speed limit bias are the values that calculate the compensation value.

When an external torque compensation value is input, the drive adds that value to the speed limit compensated torque reference value. The values L7-01 to L7-04 [Torque Limit] limit the resulting torque reference. The drive uses the value as the internal torque reference. You can use U1-09 [Torque Reference] to monitor the calculated torque reference. The torque limit values set in L7-01 to L7-04 are most important. Although you can set a higher external torque reference from an external source, the motor will not operate a torque output higher than the values set in L7-01 to L7-04.

■ Setting the Torque Reference, Speed Limit, and Torque Compensation Values

Torque Control Input Value Selection

Table 12.38 lists the method for torque control input signals.

Table 12.38 The Method for Torque Control Input Signals

Configuration Parameter	Signal Input Method	Parameter Settings	Notes
Torque Reference	Drive analog input terminals A1, A2, A3	H3-02, H3-10, H3-06 = 13 [MFAI Function Select = Torque Reference / Torque Limit] *	The level of the set input signal must align with the polarity of the external signals.
	Analog reference option cards AI-A3	<ul style="list-style-type: none"> F2-01 = 0 [Analog Input Function Selection = 3 Independent Channels] H3-02, H3-10, and H3-06 = 13 * 	H3-02, H3-10, or H3-06 settings are enabled for the option card input terminal. The level of the set input signal must align with the polarity of the external signals.
	MEMOBUS register 0004H	<ul style="list-style-type: none"> b1-01 = 2 [Frequency Reference Selection 1 = Memobus/Modbus Communications] When register bit 2 of 000FH = 1, the torque reference and torque limit from register 0004H is enabled. 	-
	Communication option card	<ul style="list-style-type: none"> b1-01 = 3 [Option PCB] F6-06 = 1 [Torque Reference/Limit by Comm = Enabled] Refer to the communication option card manual for more information about the torque reference setting.	-
Speed Limit	Frequency Reference Selection (Reference source selected with b1-01)	d5-03 = 1 [Speed Limit Selection = Active Frequency Reference] The drive gets the speed limit from the frequency reference source input in b1-01 or b1-15 [Frequency Reference Selection 2]. *	The drive applies the settings in C1-01 to C1-08 [Acceleration/Deceleration Times] and C2-01 to C2-04 [S-Curve Time @ Start/End of Accel/Decel] to the speed limit.
	d5-04 [Speed Limit]	d5-03 = 2 [d5-04 Setting]	-

Configuration Parameter	Signal Input Method	Parameter Settings	Notes
Torque Compensation	Drive analog input terminals A1, A2, A3	<i>H3-02, H3-10, or H3-06 = 14 [Torque Compensation] *1</i>	The level of the set input signal must align with the polarity of the external signals.
	Analog reference option cards AI-A3	<ul style="list-style-type: none"> <i>F2-01 = 0</i> <i>H3-02, H3-10, or H3-06 = 14 *1</i> 	<i>H3-02, H3-10, or H3-06</i> settings are enabled for the option card input terminal. The level of the set input signal must align with the polarity of the external signals.
	MEMOBUS register 0005H	<ul style="list-style-type: none"> <i>b1-01 = 2</i> When register bit 3 of 000FH = 1, the torque reference and torque limit from register 0005H is enabled. 	-
	Communication option card	<i>b1-01 = 3</i> Refer to the communication option card manual for more information about the torque reference setting.	-

*1 Sets analog input terminals A1, A2, and A3 to supply the speed limit, torque reference, or torque compensation. If you set the same function to A1 to A3 terminals with *H3-02, H3-10, or H3-06*, the drive will detect *oPE07 [Analog Input Selection Error]*.

Input Signal Polarity

The positive and negative torque references set the motor rotation direction. The direction of the Run command does not set it. The positive and negative torque reference signals and the direction of the Run command have an effect on the internal torque reference.

Table 12.39 Torque Control Signal Polarity

Run Command Direction	Torque Reference Signal Polarity	Direction of Motor Rotation	Polarity of the Internal Torque Reference [U1-09]
Forward run	+ (Positive)	Forward direction	+ (Positive)
	- (Negative)	Reverse direction	- (Negative)
Reverse run	+ (Positive)	Reverse direction	- (Negative)
	- (Negative)	Forward direction	+ (Positive)

Note:

For Yaskawa motors, the forward run direction is counterclockwise direction when seen from the load shaft.

When you use analog inputs, you can get negative input values with these methods:

- Apply negative voltage input signals.
- Use positive voltage input signals and set the analog input bias to negative values.
- Apply positive voltage input signals and use a digital input programmed for *Analog TorqueRef Polarity Invert [H1-xx = 78]*.

When you use MEMOBUS/Modbus communication or a communication option card, set the positive or negative signed torque reference.

When the level of the analog signal input is 0 V to 10 V or 4 mA to 20 mA, the torque reference is the forward direction. To reverse the polarity of the torque reference, use one of these two methods:

- Use a -10 V to +10 V voltage input
- Set *H1-xx = 78 [MFDI Function Select = Analog TorqueRef Polarity Invert]*.

■ Speed Limit and Speed Limit Bias

The drive reads the speed limit setting from the input selected in *d5-03 [Speed Limit Selection]*. You can use *d5-05 [Speed Limit Bias]* to add a bias to this speed. Parameter *d5-08 [Uni-directional Speed Limit Bias]* sets how the drive applies bias to the speed limit.

Table 12.40 shows the relation between these settings:

Table 12.40 Speed Limit, Speed Bias and Speed Limit Priority Selection

Run command	Operating Conditions							
	Forward	Reverse	Forward	Reverse	Forward	Reverse	Forward	Reverse
Torque reference direction	+ (Positive)	+ (Positive)	- (Negative)	- (Negative)	- (Negative)	- (Negative)	+ (Positive)	+ (Positive)

Operating Conditions								
Speed limit direction	+ (Positive)	- (Negative)	- (Negative)	+ (Positive)	+ (Positive)	- (Negative)	- (Negative)	+ (Positive)
Direction of motor rotation	Forward		Reverse		Forward		Reverse	
Generated torque (d5-08 = 0 [Disabled])								
Generated torque (d5-08 = 1 [Enabled])								
Application example	Wind up				Rewind			

*1 The C5 parameter set the Δn value.

Show Speed Limit Operation

When the motor is at the speed limit or more than the speed limit, the drive sends a signal to the PLC or other such control devices to tell you that an error has occurred. To enable this function, set an MFDO function [H2-01 to H2-03] to 32 [In Speed Limit During Trq Ctrl].

Switch Between Torque Control and Speed Control

Use a digital input to switch Torque Control and Speed Control. To enable this function, set H1-xx = 71 [MFDI Function Select = Torque Control] to enable this function.

When you switch from Speed Control to Torque Control, the torque limit becomes the torque reference and the speed reference becomes the speed limit. When you switch from Torque Control to Speed Control, the torque reference becomes the torque limit and the speed limit becomes the speed reference. When you must use a delay time to switch between Speed Control and Torque Control, set d5-06 [Speed/Torque Changeover Time]. During this switch delay time, the drive keeps the reference value of the Torque Control and Speed Control when the switch signal was input. Change the reference values from an external control device during this delay time.

Note:

- When you switch between Torque Control and Speed Control, set d5-01 = 0 [Torque Control Selection = Speed Control]. If d5-01 = 1 [Torque Control] and H1-xx = 71 at the same time, the drive will detect oPE15 [Torque Control Setting Error].
- If the Stop command is input, the drive will not apply the delay time set in d5-06. Torque Control will immediately switch to Speed Control and ramp to stop.

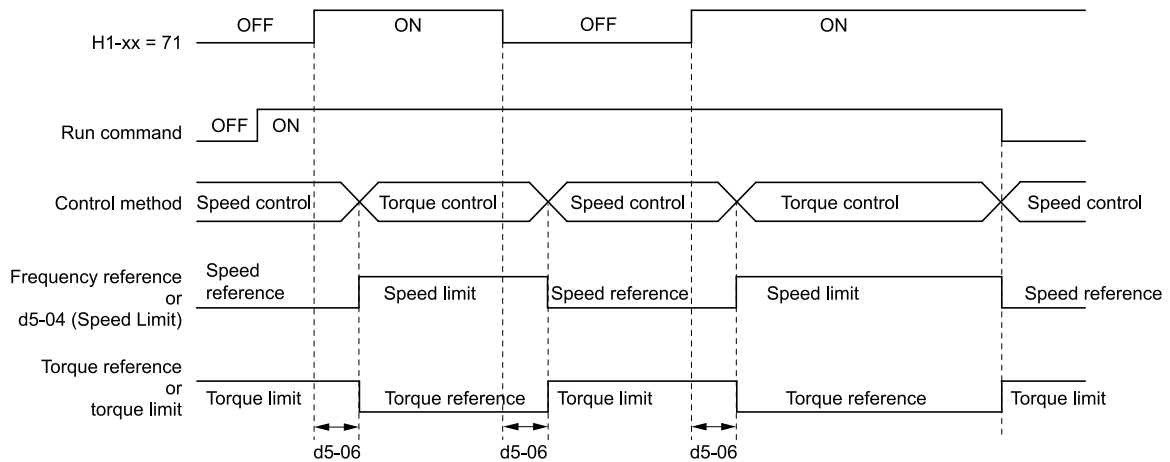

Figure 12.69 Speed/Torque Control Switching Time

■ d5-01: Torque Control Selection

No. (Hex.)	Name	Description	Default (Range)
d5-01 (029A)	Torque Control Selection	<input type="checkbox"/> V/f <input type="checkbox"/> CL-V/f <input type="checkbox"/> OLV <input checked="" type="checkbox"/> CLV <input type="checkbox"/> AOLV <input type="checkbox"/> OLVP/M <input type="checkbox"/> AOLVP/M <input type="checkbox"/> CLVP/M <input type="checkbox"/> EZOLV Sets the drive for torque control or speed control.	0 (0, 1)

0 : Speed Control

Enables Speed Control. The drive controls the speed as specified by *C5-01 to C5-07 [Speed Control (ASR) Setting Parameters]*.

Also use this setting when you use *H1-xx = 71 [MFDI Function Select = Torque Control]* to change between Speed Control and Torque Control.

1 : Torque Control

Always enables Torque Control.

■ d5-02: Torque Reference Delay Time

No. (Hex.)	Name	Description	Default (Range)
d5-02 (029B)	Torque Reference Delay Time	<input type="checkbox"/> V/f <input type="checkbox"/> CL-V/f <input type="checkbox"/> OLV <input checked="" type="checkbox"/> CLV <input type="checkbox"/> AOLV <input type="checkbox"/> OLVP/M <input type="checkbox"/> AOLVP/M <input type="checkbox"/> CLVP/M <input type="checkbox"/> EZOLV Sets the primary delay time constant for the torque reference filter.	Determined by A1-02 (0 - 1000 ms)

This parameter applies a primary delay filter to the torque reference signal to stop oscillation caused by a torque reference signal that is not stable. This also helps remove electrical interference from the torque reference signal and helps adjust the responsiveness between host controllers.

If oscillation occurs during Torque Control, increase the setting value. If the setting value is too high, responsiveness becomes unsatisfactory.

■ d5-03: Speed Limit Selection

No. (Hex.)	Name	Description	Default (Range)
d5-03 (029C)	Speed Limit Selection	<input type="checkbox"/> V/f <input type="checkbox"/> CL-V/f <input type="checkbox"/> OLV <input checked="" type="checkbox"/> CLV <input type="checkbox"/> AOLV <input type="checkbox"/> OLVP/M <input type="checkbox"/> AOLVP/M <input type="checkbox"/> CLVP/M <input type="checkbox"/> EZOLV Sets the torque control speed limit method.	1 (1, 2)

1 : Active Frequency Reference

The enabled frequency reference set in *b1-01 [Frequency Reference Selection 1]* or *b1-15 [Frequency Reference Selection 2]* will be the speed limit. The drive applies the values set in *C1-01 to C1-08 [Acceleration/Deceleration Times 1 to 4]* and *C2-01 to C2-04 [S-Curve Time @ Start/End of Accel]* as speed limits.

2 : d5-04 Setting

The speed limit is the value set in *d5-04*.

■ d5-04: Speed Limit

No. (Hex.)	Name	Description	Default (Range)
d5-04 (029D)	Speed Limit	<div style="display: flex; justify-content: space-between; align-items: center;"> V/f CL-V/f OLV CLV AOLV OLV/PM AOLV/PM CLV/PM EZOLV </div> <p>Sets the speed limit during Torque Control as a percentage of <i>E1-04 [Maximum Output Frequency]</i>. Set <i>d5-03 = 2 [Speed Limit Selection = d5-04 Setting]</i> before you set this parameter.</p>	0% (-120 - +120%)

The speed limit is a positive value when it is in the same direction as the Run command. The speed limit is a negative value when it is in the opposite direction of the Run command.

■ d5-05: Speed Limit Bias

No. (Hex.)	Name	Description	Default (Range)
d5-05 (029E)	Speed Limit Bias	<div style="display: flex; justify-content: space-between; align-items: center;"> V/f CL-V/f OLV CLV AOLV OLV/PM AOLV/PM CLV/PM EZOLV </div> <p>Sets the speed limit bias value as a percentage of <i>E1-04 [Maximum Output Frequency]</i>.</p>	10% (0 - 120%)

Adjusts the margin for the speed limit.

■ d5-06: Speed/Torque Changeover Time

No. (Hex.)	Name	Description	Default (Range)
d5-06 (029F)	Speed/Torque Changeover Time	<div style="display: flex; justify-content: space-between; align-items: center;"> V/f CL-V/f OLV CLV AOLV OLV/PM AOLV/PM CLV/PM EZOLV </div> <p>Sets the delay time to switch between Speed Control and Torque Control. Set <i>H1-xx = 71 [MFDI Function Selection = Torque Control]</i> before you set this parameter.</p>	0 ms (0 - 1000 ms)

The analog input (torque reference, speed limit value) holds at the value when the drive switched between Speed and Torque Control in the time of the Speed/Torque Changeover Timer. During this time, prepare to switch to an external source.

■ d5-08: Uni-directional Speed Limit Bias

No. (Hex.)	Name	Description	Default (Range)
d5-08 (02B5)	Uni-directional Speed Limit Bias	<div style="display: flex; justify-content: space-between; align-items: center;"> V/f CL-V/f OLV CLV AOLV OLV/PM AOLV/PM CLV/PM EZOLV </div> <p>Sets the direction of the speed limit reference to which Speed Limit Bias [<i>d5-05</i>] applies.</p>	1 (0, 1)

0 : Disabled

The drive applies the speed limit bias in the speed limit direction and the opposite direction.

1 : Enabled

The drive applies the speed limit bias in the opposite direction of the speed limit only.

◆ d6: Field Weakening /Forcing

d6 parameters set the field weakening and field forcing functions.

The field weakening function decreases the energy consumption of the motor. It decreases the output voltage of the drive to a set level. The function decreases the motor excitation current inversely proportional to speed in a constant output range, and does not let the induced voltage of the motor become more than the power supply voltage. To enable this function, set *Field Weakening [H1-xx = 63]* ON.

Note:

Use the Field Weakening function in constant light-load applications. To control the energy consumption of the motor for other load conditions, use the *b8 parameters [Energy Saving]*.

The Field Forcing function adjusts the delaying influence of the motor time constant when the drive changes the excitation current reference and it also increases motor responsiveness. This function uses a high motor excitation current reference for drive start-up only to help develop actual motor excitation current. Enable the Field Forcing function to increase motor responsiveness.

Note:

You cannot use Field Forcing during DC Injection Braking.

■ d6-01: Field Weakening Level

No. (Hex.)	Name	Description	Default (Range)
d6-01 (02A0)	Field Weakening Level	<div style="display: flex; justify-content: space-between; gap: 5px;"> V/f CL-V/f OLV CLV AOLV OLV/PM AOLV/PM CLV/PM EZOLV </div> Sets the drive output voltage as a percentage of <i>E1-05 [Maximum Output Voltage]</i> when <i>H1-xx = 63 [Field Weakening]</i> is activated.	80% (0 - 100%)

■ d6-02: Field Weakening Frequency Limit

No. (Hex.)	Name	Description	Default (Range)
d6-02 (02A1)	Field Weakening Frequency Limit	<div style="display: flex; justify-content: space-between; gap: 5px;"> V/f CL-V/f OLV CLV AOLV OLV/PM AOLV/PM CLV/PM EZOLV </div> Sets the minimum output frequency to start field weakening.	0.0 Hz (0.0 - 590.0 Hz)

Make sure that these two conditions are correct to enable the Field Weakening command:

- The output frequency \geq *d6-02*.
- There is a speed agreement status.

■ d6-03: Field Forcing Selection

No. (Hex.)	Name	Description	Default (Range)
d6-03 (02A2)	Field Forcing Selection	<div style="display: flex; justify-content: space-between; gap: 5px;"> V/f CL-V/f OLV CLV AOLV OLV/PM AOLV/PM CLV/PM EZOLV </div> Sets the field forcing function.	0 (0, 1)

0 : Disabled

1 : Enabled

■ d6-06: Field Forcing Limit

No. (Hex.)	Name	Description	Default (Range)
d6-06 (02A5)	Field Forcing Limit	<div style="display: flex; justify-content: space-between; gap: 5px;"> V/f CL-V/f OLV CLV AOLV OLV/PM AOLV/PM CLV/PM EZOLV </div> Sets the limit value for field forcing to increase the motor excitation current reference as a percentage of <i>E2-03 [Motor No-Load Current]</i> . Usually it is not necessary to change this setting.	400% (100 - 400%)

Note:

You cannot use Field Forcing during DC Injection Braking.

◆ d7: Offset Frequency

The drive will use 3 digital signal inputs, to add or subtract the set frequency (Offset frequency) to/from the frequency reference and correct the speed. The drive uses the terminal set in *H1-xx = 44 to 46 [MFDI Function Select = Add Offset Frequency 1 to 3]* to set the Offset frequency. When you close more than one input at the same time, the drive adds the selected offset values together.

Figure 12.70 shows the Offset frequency function:

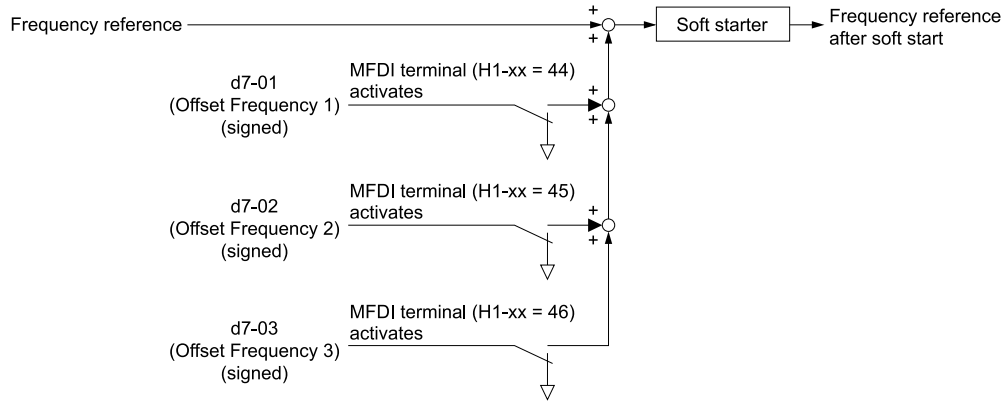

Figure 12.70 Offset Frequency Operation

■ d7-01: Offset Frequency 1

No. (Hex.)	Name	Description	Default (Range)
d7-01 (02B2) RUN	Offset Frequency 1	V/f CL-V/f OLV CLV AOLV OLV/PM AOLV/PM CLV/PM EZOLV Uses H1-xx = 44 [MFDI Function Select = Add Offset Frequency 1 (d7-01)] as a percentage of the Maximum Output Frequency to add or subtract the set frequency to/from the frequency reference.	0.0% (-100.0 - +100.0%)

■ d7-02: Offset Frequency 2

No. (Hex.)	Name	Description	Default (Range)
d7-02 (02B3) RUN	Offset Frequency 2	V/f CL-V/f OLV CLV AOLV OLV/PM AOLV/PM CLV/PM EZOLV Uses H1-xx = 45 [MFDI Function Select = Add Offset Frequency 2 (d7-02)] as a percentage of the Maximum Output Frequency to add or subtract the set frequency to/from the frequency reference.	0.0% (-100.0 - +100.0%)

■ d7-03: Offset Frequency 3

No. (Hex.)	Name	Description	Default (Range)
d7-03 (02B4) RUN	Offset Frequency 3	V/f CL-V/f OLV CLV AOLV OLV/PM AOLV/PM CLV/PM EZOLV Uses H1-xx = 46 [MFDI Function Select = Add Offset Frequency 3 (d7-03)] as a percentage of the Maximum Output Frequency to add or subtract the set frequency to/from the frequency reference.	0.0% (-100.0 - +100.0%)

12.6 E: Motor Parameters

E parameters cover drive input voltage, V/f pattern, and motor parameters.

◆ E1: V/f Pattern for Motor 1

E1 parameters are used to set the drive input voltage and motor V/f characteristics. To switch drive operation from one motor to another motor, set the V/f characteristics for motor 1.

■ V/f Pattern Settings

The drive uses a V/f pattern to adjust the output voltage relative to the frequency reference.

This product has been preconfigured with 15 voltage/frequency (V/f) patterns. Use *E1-03 [V/f Pattern Selection]* to select the V/f pattern that is appropriate for the application.

Additionally, one custom V/f pattern is available. Set *E1-03 = F [Custom]* and then manually set parameters *E1-04* to *E1-10*.

Table 12.41 Predefined V/f Patterns

Setting Value	Specification	Characteristic	Application
0	VT, 50Hz	Constant torque	For general purpose applications. This pattern is used when the load torque is constant without any rotation speed such as that used for linear conveyor systems.
1	VT, 60 Hz		
2	Const Trq, 50Hz base, 60Hz max		
3	Const Trq, 60 Hz base, 72 Hz max		
4	VT, 50 Hz, 65% Vmid reduction	Derated Torque Characteristics	This pattern is used for torque loads proportional to 2 or 3 times the rotation speed, such as is the case with fans and pumps.
5	VT, 50 Hz, 50% Vmid reduction		
6	VT, 60 Hz, 65% Vmid reduction		
7	VT, 60 Hz, 50% Vmid reduction		
8	High Trq, 50 Hz, 25% Vmin Boost	High starting torque	This pattern is used when strong torque is required during startup.
9	High Trq, 50 Hz, 65% Vmin Boost		
A	High Trq, 60 Hz, 25% Vmin Boost		
B	High Trq, 60 Hz, 65% Vmin Boost		
C	Const Trq, 60 Hz base, 90 Hz max	Constant output	This pattern is used to rotate motors at greater than 60 Hz. Output voltage is constant when operating at greater than 60 Hz.
D	Const Trq, 60 Hz base, 120 Hz max		
E	Const Trq, 60 Hz base, 180 Hz max		
F	V/f Pattern Selection	Constant torque	Enables a custom V/f pattern by changing <i>E1-04</i> to <i>E1-13 [V/f Pattern for Motor 1]</i> . The default settings for <i>E1-04</i> to <i>E1-13</i> are the same as <i>Setting Value 1 [Const Trq, 60Hz base, 60Hz max]</i> .

Note:

Be aware of the following points when manually setting V/f patterns.

- To set linear V/f characteristics at frequencies lower than E1-06 [Base Frequency], set E1-07 = E1-09 [Mid Point A Frequency = Minimum Output Frequency]. In this application, the drive ignores E1-08 [Mid Point A Voltage].
- Set the five frequencies as specified by these rules: Incorrect settings will cause oPE10 [V/f Data Setting Error].
 $E1-09 \leq E1-07 < E1-06 \leq E1-11 \leq E1-04$ [Minimum Output Frequency \leq Mid Point A Frequency $<$ Base Frequency \leq Mid Point B Frequency \leq Maximum Output Frequency]
- Setting E1-11 = 0 [Mid Point B Frequency = 0 Hz] disables E1-12 [Mid Point B Voltage]. Ensure that the four frequencies are set according to the following rules;
 $E1-09 \leq E1-07 < E1-06 \leq E1-04$
- When you use A1-03 [Initialize] to initialize the drive, it will not reset E1-03.

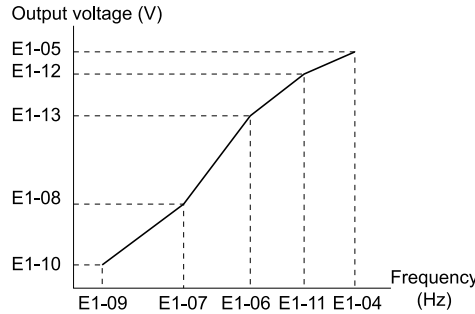

Figure 12.71 V/f Pattern

■ **E1-01: Input AC Supply Voltage**

No. (Hex.)	Name	Description	Default (Range)
E1-01 (0300)	Input AC Supply Voltage	V/f CL-V/f OLV CLV AOLV OLV/PM AOLV/PM CLV/PM EZOLV Sets the drive input voltage.	200 V Class: 240 V, 400 V: 480 V (200 V Class: 155 to 255 V, 400 V Class: 310 to 510 V)

NOTICE: Set parameter E1-01 to align with the drive input voltage (not motor voltage). If this parameter is incorrect, the protective functions of the drive will not operate correctly and it can cause damage to the drive.

Values Related to the Drive Input Voltage

The value set in E1-01 is the base value that the drive uses for the motor protective functions in Table 12.42. With a 400 V class drive, the detection level changes for some motor protective functions.

Table 12.42 Values Related to the Drive Input Voltage

Voltage	E1-01 Setting	Approximate Values				
		ov Detection Level	BTR Operation Level (rr Detection Level) *	L2-05 [Undervoltage Detection Lvl (Uv1)]	L2-11 [KEB DC Bus Voltage Setpoint]	L3-17 [DC Bus Regulation Level]
200 V class	All settings	410 V	394 V	190 V	260 V	375 V
400 V class	Setting value \geq 400 V	820 V	788 V	380 V	500 V	750 V
	Setting value $<$ 400 V	820 V	788 V	350 V	460 V	750 V

*1 This is the protection function enabled in drives with built-in braking transistors. These values show the level that will trigger the built-in braking transistor. Refer to “YASKAWA AC Drive 72060001 Series Option Braking Unit and Braking Resistor Unit Installation Manual (TOBPC72060001)” for more information.

■ **E1-03: V/f Pattern Selection**

No. (Hex.)	Name	Description	Default (Range)
E1-03 (0302)	V/f Pattern Selection	V/f CL-V/f OLV CLV AOLV OLV/PM AOLV/PM CLV/PM EZOLV Sets the V/f pattern for the drive and motor. You can use one of the preset patterns or you can make a custom pattern.	F (Determined by A1-02)

Note:

- When $A1-02 = 2$ [Control Method Selection = OLV], settings 0 to E are not available.
- Set the correct V/f pattern for the application and operation area. An incorrect V/f pattern can decrease motor torque and increase current from overexcitation.
- Parameter $A1-03$ [Initialize Parameters] will not reset the value of $E1-03$.

0 : Const Trq, 50Hz base, 50Hz max

Use this constant torque pattern for general applications. This pattern is used when the load torque is constant without any rotation speed such as that used for linear conveyor systems.

Note:

The voltage values in the figures are for 200 V class drives. Multiply the values by 2 for 400 V class drives.

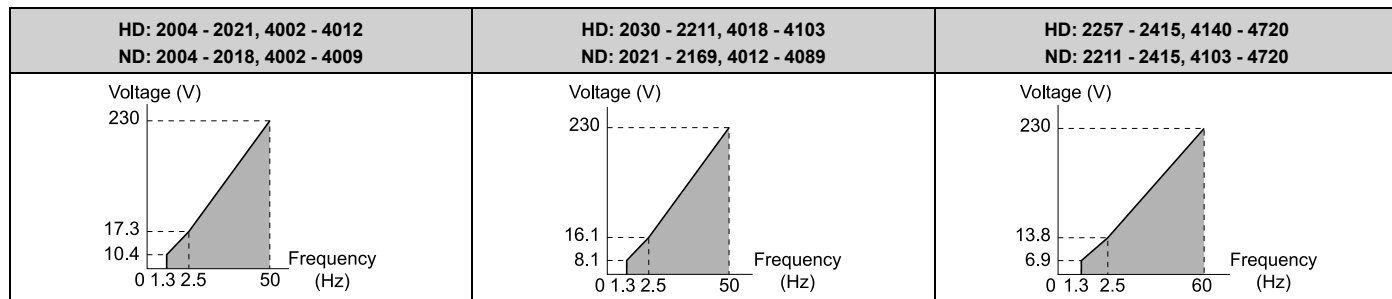

1 : Const Trq, 60Hz base, 60Hz max

Use this constant torque pattern for general applications. This pattern is used when the load torque is constant without any rotation speed such as that used for linear conveyor systems.

Note:

The voltage values in the figures are for 200 V class drives. Multiply the values by 2 for 400 V class drives.

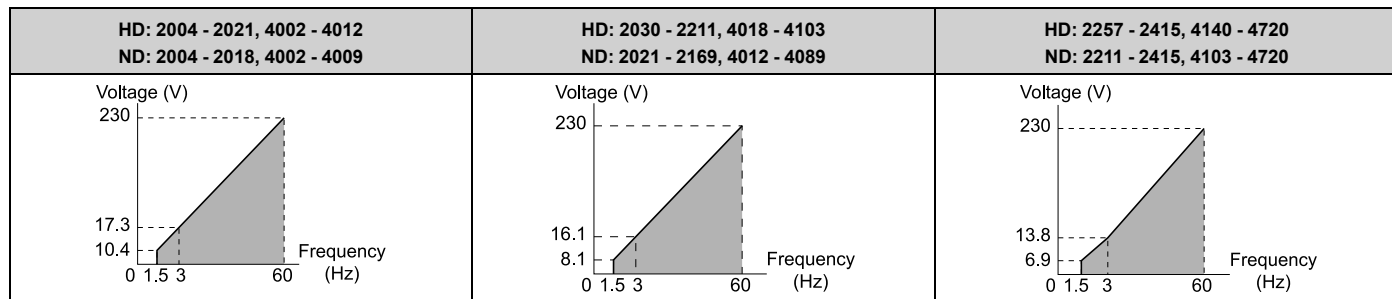

2 : Const Trq, 50Hz base, 60Hz max

Use this constant torque pattern for general applications. This pattern is used when the load torque is constant without any rotation speed such as that used for linear conveyor systems.

Note:

The voltage values in the figures are for 200 V class drives. Multiply the values by 2 for 400 V class drives.

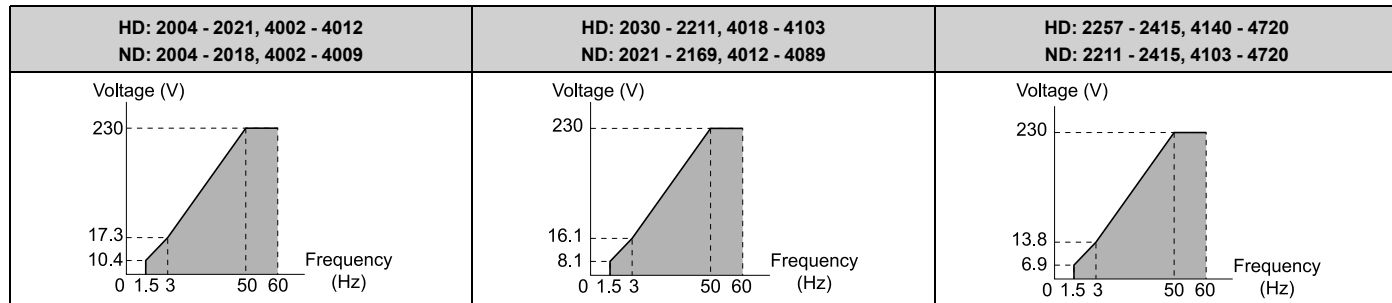

3 : Const Trq, 60 Hz base, 72 Hz max

12.6 E: Motor Parameters

Use this constant torque pattern for general applications. This pattern is used when the load torque is constant without any rotation speed such as that used for linear conveyor systems.

Note:

The voltage values in the figures are for 200 V class drives. Multiply the values by 2 for 400 V class drives.

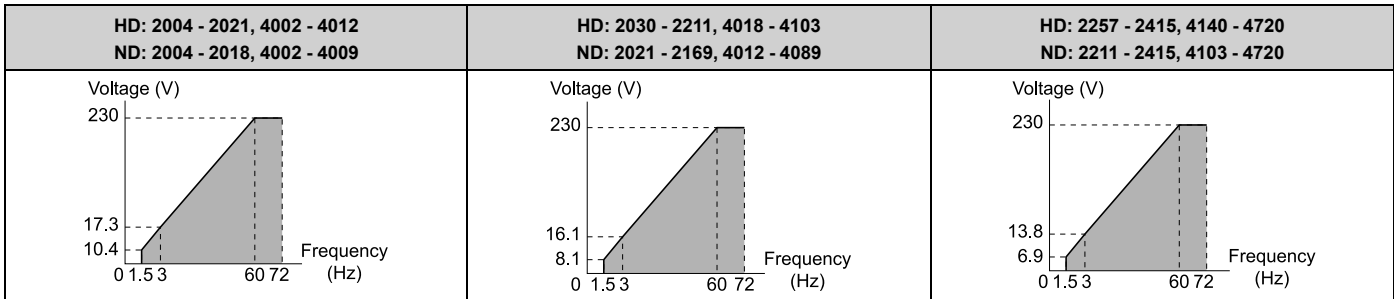

4 : VT, 50Hz, 65% Vmid reduction

Use this derated torque pattern for torque loads proportional to three times the rotation speed. For example, fans and pumps.

Note:

The voltage values in the figures are for 200 V class drives. Multiply the values by 2 for 400 V class drives.

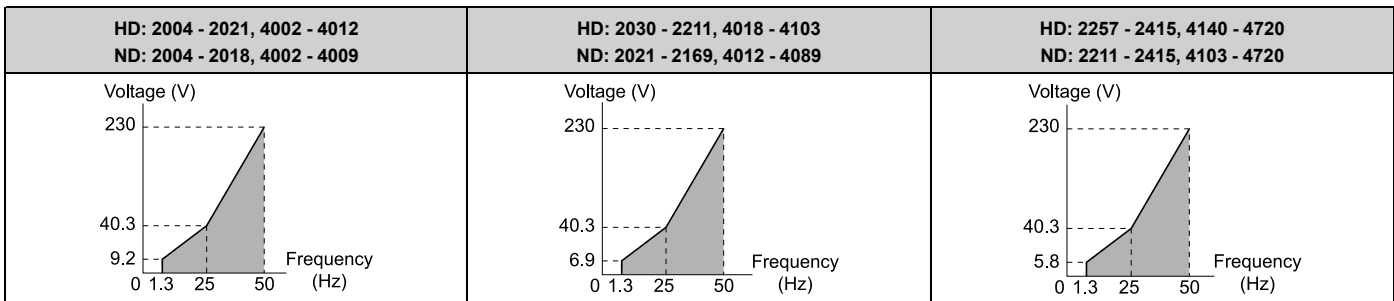

5 : VT, 50Hz, 50% Vmid reduction

Use this derated torque pattern for torque loads proportional to two times the rotation speed. For example, fans and pumps.

Note:

The voltage values in the figures are for 200 V class drives. Multiply the values by 2 for 400 V class drives.

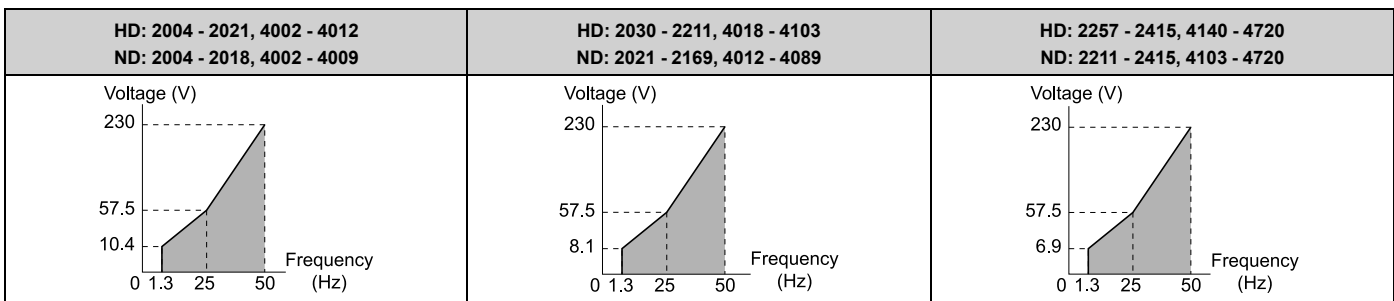

6 : VT, 60 Hz, 65% Vmid reduction

Use this derated torque pattern for torque loads proportional to three times the rotation speed. For example, fans and pumps.

Note:

The voltage values in the figures are for 200 V class drives. Multiply the values by 2 for 400 V class drives.

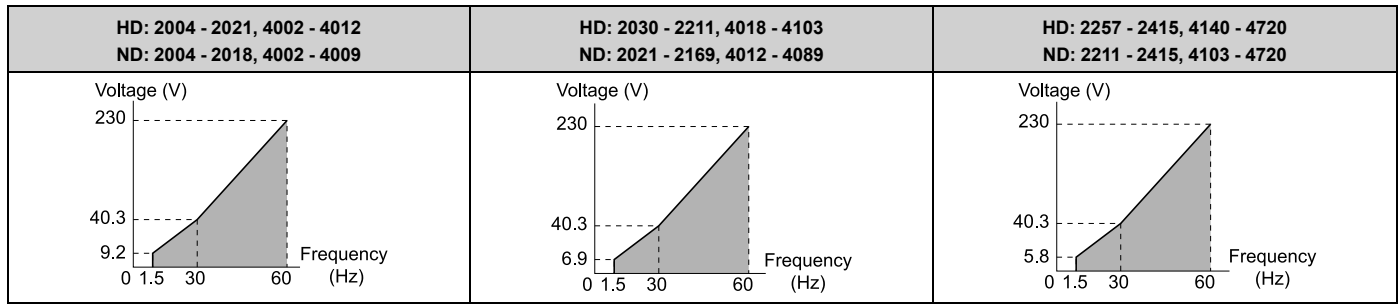

7 : VT, 60 Hz, 50% Vmid reduction

Use this derated torque pattern for torque loads proportional to two times the rotation speed. For example, fans and pumps.

Note:

The voltage values in the figures are for 200 V class drives. Multiply the values by 2 for 400 V class drives.

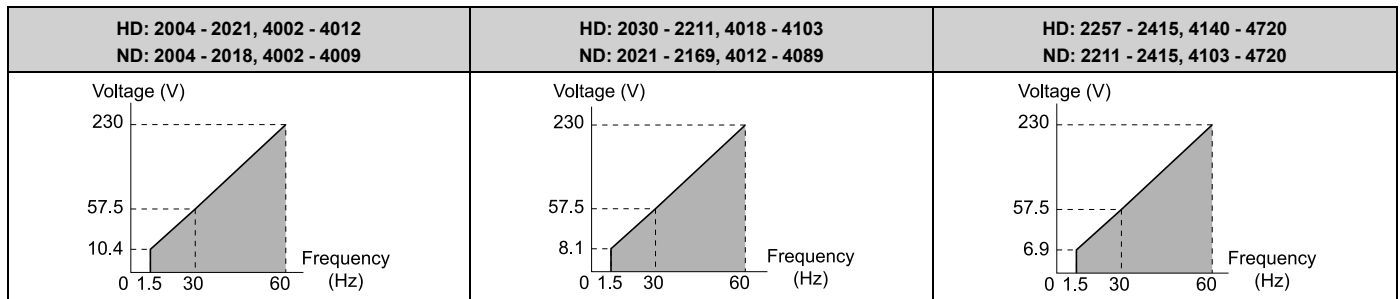

8 : High Trq, 50 Hz, 25% Vmin Boost

Use this pattern when moderate torque is necessary during start up.

Select this pattern only in these conditions:

- The wiring distance between the drive and motor is 150 m (492.1 ft) minimum.
- There is an AC reactor connected to the drive output.

Note:

The voltage values in the figures are for 200 V class drives. Multiply the values by 2 for 400 V class drives.

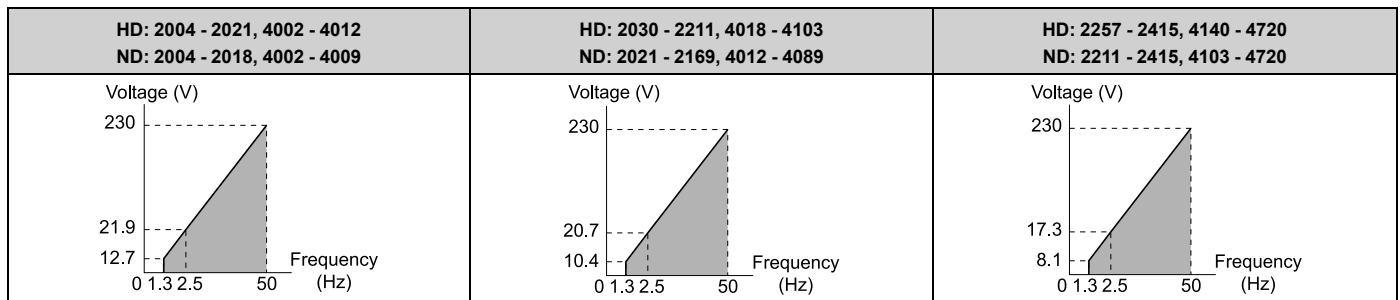

9 : High Trq, 50 Hz, 65% Vmin Boost

Use this pattern when high torque is necessary during start up.

Select this pattern only in these conditions:

- The wiring distance between the drive and motor is 150 m (492.1 ft) minimum.
- There is an AC reactor connected to the drive output.

Note:

The voltage values in the figures are for 200 V class drives. Multiply the values by 2 for 400 V class drives.

12.6 E: Motor Parameters

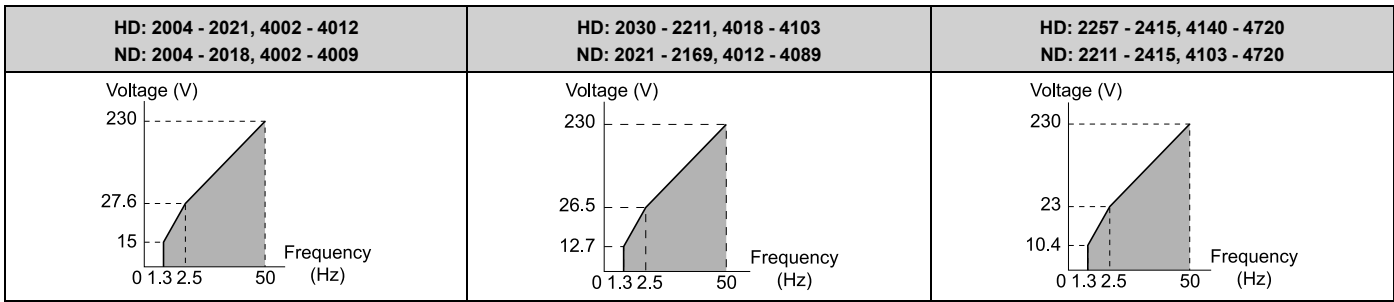

A : High Trq, 60 Hz, 25% Vmin Boost

Use this pattern when moderate torque is necessary during start up.

Select this pattern only in these conditions:

- The wiring distance between the drive and motor is 150 m (492.1 ft) minimum.
- There is an AC reactor connected to the drive output.

Note:

The voltage values in the figures are for 200 V class drives. Multiply the values by 2 for 400 V class drives.

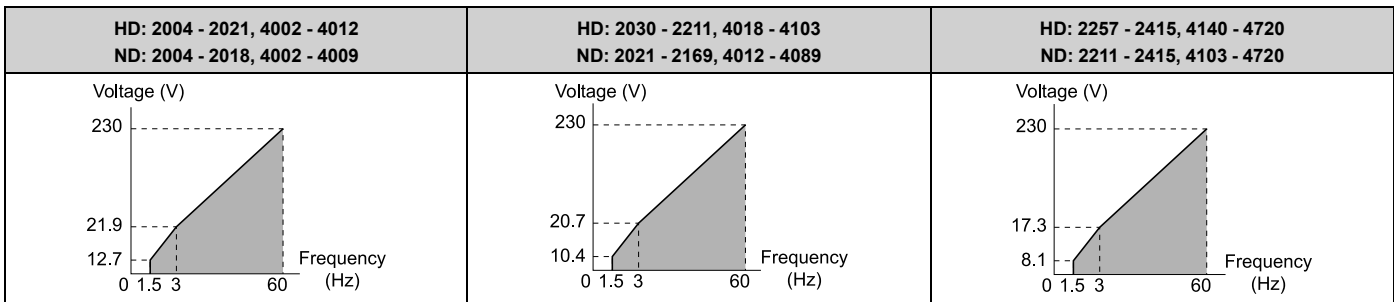

B : High Trq, 60 Hz, 65% Vmin Boost

Use this pattern when high torque is necessary during start up.

Select this pattern only in these conditions:

- The wiring distance between the drive and motor is 150 m (492.1 ft) minimum.
- There is an AC reactor connected to the drive output.

Note:

The voltage values in the figures are for 200 V class drives. Multiply the values by 2 for 400 V class drives.

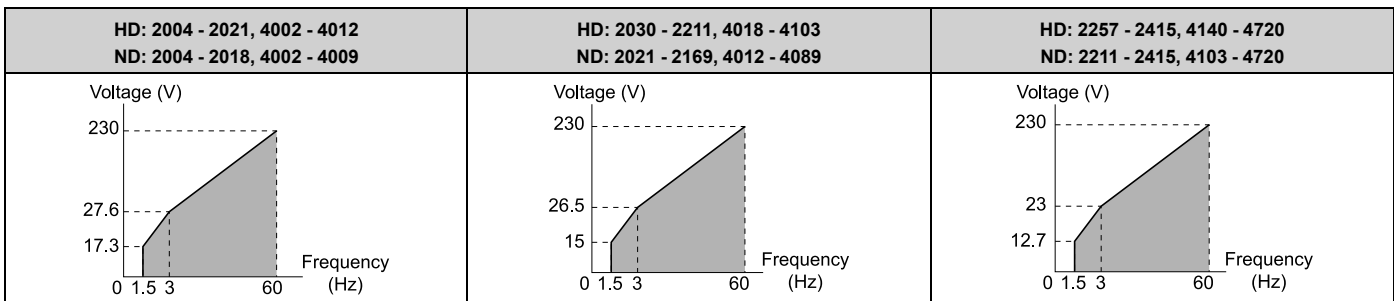

C : Const Trq, 60 Hz base, 90 Hz max

Use this constant output pattern to rotate motors at more than 60 Hz. Output voltage is constant when you operate at more than 60 Hz.

Note:

The voltage values in the figures are for 200 V class drives. Multiply the values by 2 for 400 V class drives.

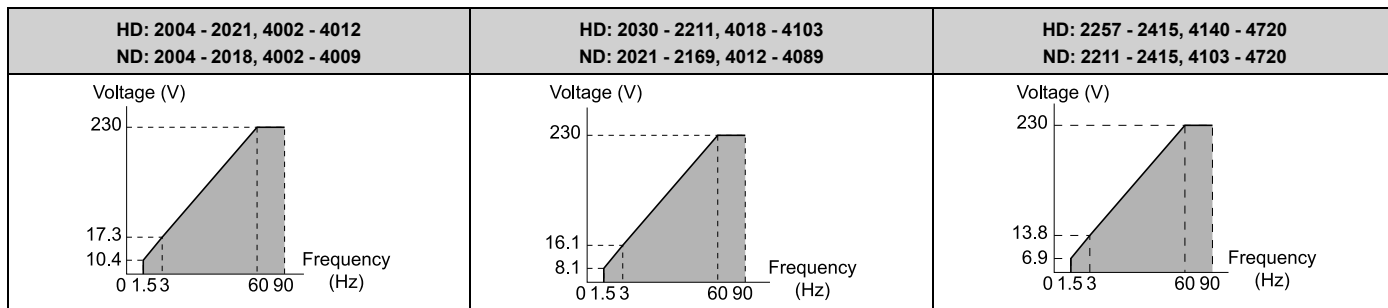

D : Const Trq, 60 Hz base, 120 Hz max

Use this constant output pattern to rotate motors at more than 60 Hz. Output voltage is constant when you operate at more than 60 Hz.

Note:

The voltage values in the figures are for 200 V class drives. Multiply the values by 2 for 400 V class drives.

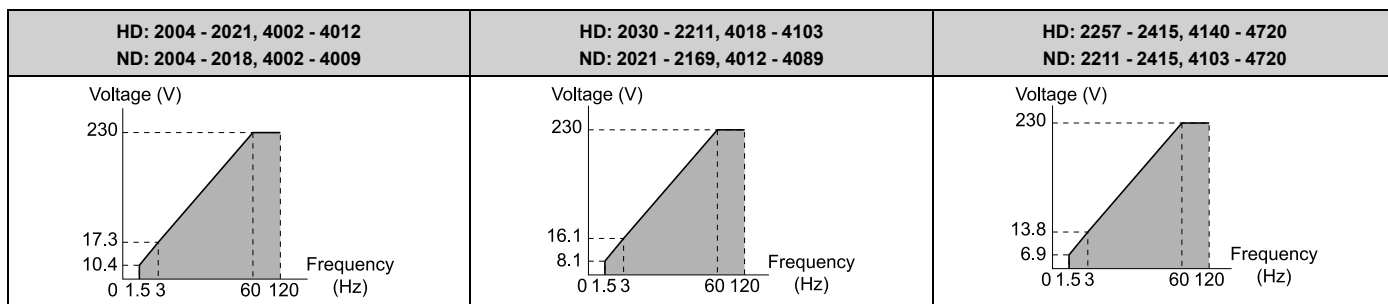

E : Const Trq, 60 Hz base, 180 Hz max

Use this constant output pattern to rotate motors at more than 60 Hz. Output voltage is constant when you operate at more than 60 Hz.

Note:

The voltage values in the figures are for 200 V class drives. Multiply the values by 2 for 400 V class drives.

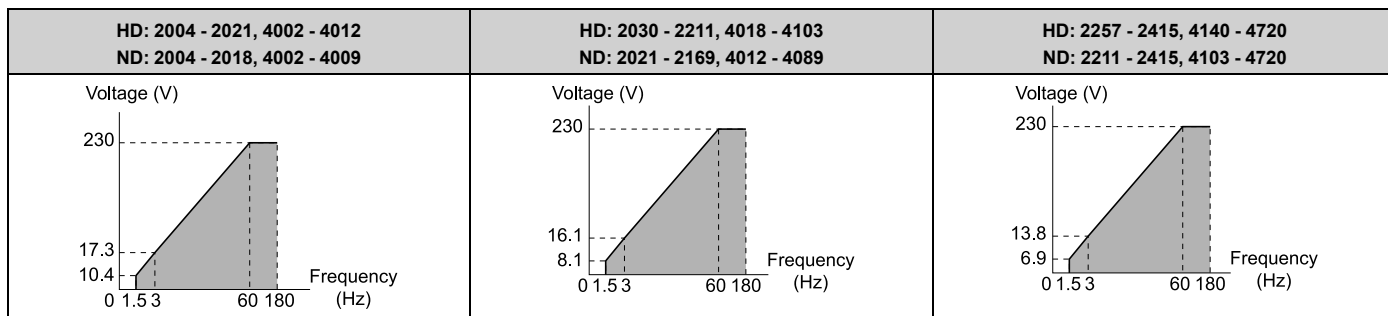

F : V/f Pattern Selection

Set E1-04 to E1-13 [V/f Pattern for Motor 1] to set the values for this custom pattern.

The default settings are the same as Setting Value 1 [Const Trq, 60Hz base, 60Hz max].

E1-04: Maximum Output Frequency

No. (Hex.)	Name	Description	Default (Range)
E1-04 (0303)	Maximum Output Frequency	V/f CL-V/f OLV CLV AOLV OLV/PM AOLV/PM CLV/PM EZOLV Sets the maximum output frequency for the V/f pattern.	Determined by A1-02 and E5-01 (Determined by A1-02 and E5-01)

■ E1-05: Maximum Output Voltage

No. (Hex.)	Name	Description	Default (Range)
E1-05 (0304)	Maximum Output Voltage	<div style="display: flex; justify-content: space-between; font-size: 0.8em;"> V/f CL-V/f OLV CLV AOLV OLV/PM AOLV/PM CLV/PM EZOLV </div> Sets the maximum output voltage for the V/f pattern.	200 V Class: 230.0 V, 400 V: 460.0 V (200 V Class: 0.0 - 255.0 V, 400 V Class: 0.0 - 510.0 V)

■ E1-06: Base Frequency

No. (Hex.)	Name	Description	Default (Range)
E1-06 (0305)	Base Frequency	<div style="display: flex; justify-content: space-between; font-size: 0.8em;"> V/f CL-V/f OLV CLV AOLV OLV/PM AOLV/PM CLV/PM EZOLV </div> Sets the base frequency for the V/f pattern.	Determined by A1-02 and E5-01 (0.0 - E1-04)

■ E1-07: Mid Point A Frequency

No. (Hex.)	Name	Description	Default (Range)
E1-07 (0306)	Mid Point A Frequency	<div style="display: flex; justify-content: space-between; font-size: 0.8em;"> V/f CL-V/f OLV CLV AOLV OLV/PM AOLV/PM CLV/PM EZOLV </div> Sets a middle output frequency for the V/f pattern.	Determined by A1-02 (0.0 - E1-04)

■ E1-08: Mid Point A Voltage

No. (Hex.)	Name	Description	Default (Range)
E1-08 (0307)	Mid Point A Voltage	<div style="display: flex; justify-content: space-between; font-size: 0.8em;"> V/f CL-V/f OLV CLV AOLV OLV/PM AOLV/PM CLV/PM EZOLV </div> Sets a middle output voltage for the V/f pattern.	Determined by A1-02, C6-01 and o2-04 (200 V Class: 0.0 - 255.0 V, 400 V Class: 0.0 - 510.0 V)

Note:

Default setting is determined by *A1-02 [Control Method Selection]*, *C6-01 [Normal / Heavy Duty Selection]*, and *o2-04 [Drive Model Selection]*.

■ E1-09: Minimum Output Frequency

No. (Hex.)	Name	Description	Default (Range)
E1-09 (0308)	Minimum Output Frequency	<div style="display: flex; justify-content: space-between; font-size: 0.8em;"> V/f CL-V/f OLV CLV AOLV OLV/PM AOLV/PM CLV/PM EZOLV </div> Sets the minimum output frequency for the V/f pattern.	Determined by A1-02 and E5-01 (Determined by A1-02, E1-04, and E5-01)

■ E1-10: Minimum Output Voltage

No. (Hex.)	Name	Description	Default (Range)
E1-10 (0309)	Minimum Output Voltage	<div style="display: flex; justify-content: space-between; font-size: 0.8em;"> V/f CL-V/f OLV CLV AOLV OLV/PM AOLV/PM CLV/PM EZOLV </div> Sets the minimum output voltage for the V/f pattern.	Determined by A1-02 (200 V Class: 0.0 to 255.0 V, 400 V Class: 0.0 to 510.0 V)

■ E1-11: Mid Point B Frequency

No. (Hex.)	Name	Description	Default (Range)
E1-11 (030A) Expert	Mid Point B Frequency	<div style="display: flex; justify-content: space-between; font-size: 0.8em;"> V/f CL-V/f OLV CLV AOLV OLV/PM AOLV/PM CLV/PM EZOLV </div> Sets a middle output frequency for the V/f pattern.	0.0 Hz (0.0 - E1-04)

Note:

Set this parameter to *0.0* to disable the function.

■ E1-12: Mid Point B Voltage

No. (Hex.)	Name	Description	Default (Range)
E1-12 (030B) Expert	Mid Point B Voltage	<div style="display: flex; justify-content: space-between; font-size: 0.8em; font-weight: bold;"> V/f CL-V/f OLV CLV AOLV OLV/PM AOLV/PM CLV/PM EZOLV </div> Sets a middle point voltage for the V/f pattern.	0.0 V (200 V Class: 0.0 to 255.0 V, 400 V Class: 0.0 to 510.0 V)

Note:

Set this parameter to 0.0 to disable the function.

■ E1-13: Base Voltage

No. (Hex.)	Name	Description	Default (Range)
E1-13 (030C) Expert	Base Voltage	<div style="display: flex; justify-content: space-between; font-size: 0.8em; font-weight: bold;"> V/f CL-V/f OLV CLV AOLV OLV/PM AOLV/PM CLV/PM EZOLV </div> Sets the base voltage for the V/f pattern.	0.0 V (200 V Class: 0.0 - 255.0 V, 400 V Class: 0.0 - 510.0 V)

Note:

- After Auto-Tuning, the value of *E1-13* = *E1-05* [Maximum Output Voltage].
- When *E1-13* = 0.0, use the value of *E1-05* to control the voltage.

◆ E2: Motor Parameters

E2 parameters [Motor Parameters] are used to set induction motor data. To switch drive operation from one motor to another motor, configure the first motor (motor 1).

Performing Auto-Tuning automatically sets the *E2 parameters* to the optimal values. If Auto-Tuning cannot be performed, set the *E2 parameters* manually.

Note:

If *A1-02* [Control Method Selection] is set to the following control modes, the keypad does not display *E2-xx*.

- 5 [PM Open Loop Vector]
- 6 [PM Advanced Open Loop Vector]
- 7 [PM Closed Loop Vector]
- 8 [EZ Vector Control]

■ E2-01: Motor Rated Current (FLA)

No. (Hex.)	Name	Description	Default (Range)
E2-01 (030E)	Motor Rated Current (FLA)	<div style="display: flex; justify-content: space-between; font-size: 0.8em; font-weight: bold;"> V/f CL-V/f OLV CLV AOLV OLV/PM AOLV/PM CLV/PM EZOLV </div> Sets the motor rated current in amps.	Determined by o2-04, C6-01 (10% to 200% of the drive rated current)

Note:

- If *E2-01* < *E2-03* [Motor No-Load Current], the drive will detect *oPE02* [Parameter Range Setting Error].
- When the drive model changes, the display units for this parameter also change.
 - 0.01 A: models 2004 to 2042, 4002 to 4023
 - 0.1 A: models 2056 to 2415, 4031 to 4720

The value set for *E2-01* becomes the reference value for motor protection, the torque limit, and torque control. Enter the motor rated current shown on the motor nameplate. Auto-Tuning the drive will automatically set *E2-01* to the value input for “Motor Rated Current”.

■ E2-02: Motor Rated Slip

No. (Hex.)	Name	Description	Default (Range)
E2-02 (030F)	Motor Rated Slip	<div style="display: flex; justify-content: space-between; font-size: 0.8em; font-weight: bold;"> V/f CL-V/f OLV CLV AOLV OLV/PM AOLV/PM CLV/PM EZOLV </div> Sets motor rated slip.	Determined by o2-04, C6-01 (0.000 - 20.000 Hz)

12.6 E: Motor Parameters

This parameter value becomes the base slip compensation value. The drive automatically sets this parameter during Auto-Tuning. When you cannot do Auto-Tuning, calculate the motor rated slip with the information on the motor nameplate and this formula:

$$E2-02 = f - (n \times p) / 120$$

- f: Motor rated frequency (Hz)
- n: Rated motor speed (min^{-1} (r/min))
- p: Number of motor poles

■ E2-03: Motor No-Load Current

No. (Hex.)	Name	Description	Default (Range)
E2-03 (0310)	Motor No-Load Current	<input type="checkbox"/> V/f <input type="checkbox"/> CL-V/f <input type="checkbox"/> OLV <input type="checkbox"/> CLV <input type="checkbox"/> AOLV <input type="checkbox"/> OLV/PM <input type="checkbox"/> AOLV/PM <input type="checkbox"/> CLV/PM <input type="checkbox"/> EZOLV Sets the no-load current for the motor in amps when operating at the rated frequency and the no-load voltage.	Determined by o2-04, C6-01 (0 to E2-01)

Note:

The default settings and setting ranges are in these units:

- 0.01 A: 2004 to 2042, 4002 to 4023
- 0.1 A: 2056 to 2415, 4031 to 4720

The drive automatically sets this parameter during Auto-Tuning. When you cannot do Auto-Tuning, you can also use the motor no-load current on the motor test report to enter this value manually. Contact the motor manufacturer to receive a copy of the motor test report.

Note:

The default setting of the no-load current is for operation with a 4-pole motor recommended by Yaskawa.

■ E2-04: Motor Pole Count

No. (Hex.)	Name	Description	Default (Range)
E2-04 (0311)	Motor Pole Count	<input type="checkbox"/> V/f <input type="checkbox"/> CL-V/f <input type="checkbox"/> OLV <input type="checkbox"/> CLV <input type="checkbox"/> AOLV <input type="checkbox"/> OLV/PM <input type="checkbox"/> AOLV/PM <input type="checkbox"/> CLV/PM <input type="checkbox"/> EZOLV Sets the number of motor poles.	4 (2 - 120)

Note:

- When $A1-02 = 0, 1, 3$ [Control Method Selection = V/f, CL-V/f, CLV], the maximum value is 120.
- When $A1-02 = 2, 4$ [OLV, AOLV], the maximum value is 48.

Auto-Tuning automatically sets this parameter to the value of [Number of Motor Poles].

■ E2-05: Motor Line-to-Line Resistance

No. (Hex.)	Name	Description	Default (Range)
E2-05 (0312)	Motor Line-to-Line Resistance	<input type="checkbox"/> V/f <input type="checkbox"/> CL-V/f <input type="checkbox"/> OLV <input type="checkbox"/> CLV <input type="checkbox"/> AOLV <input type="checkbox"/> OLV/PM <input type="checkbox"/> AOLV/PM <input type="checkbox"/> CLV/PM <input type="checkbox"/> EZOLV Sets the line-to-line resistance for the motor stator windings.	Determined by o2-04, C6-01 (0.000 - 65.000 Ω)

Note:

This value is the motor line-to-line resistance. Do not set this parameter with the per-phase resistance.

Auto-Tuning automatically sets this parameter. If you cannot do Auto-Tuning, use the test report from the motor manufacturer to configure the settings. You can calculate the motor line-to-line resistance with one of these formulas:

- E-type insulation: [the resistance value (Ω) shown on the test report at 75 °C] \times 0.92
- B-type insulation: [the resistance value (Ω) shown on the test report at 75 °C] \times 0.92
- F-type insulation: [the resistance value (Ω) shown on the test report at 115 °C] \times 0.87

■ E2-06: Motor Leakage Inductance

No. (Hex.)	Name	Description	Default (Range)
E2-06 (0313)	Motor Leakage Inductance	<div style="display: flex; justify-content: space-between; font-size: 0.8em; font-weight: normal;"> V/f CL-V/f OLV CLV AOLV OLV/PM AOLV/PM CLV/PM EZOLV </div> <p>Sets the voltage drop from motor leakage inductance when the motor is operating at the rated frequency and rated current. This value is a percentage of Motor Rated Voltage.</p>	Determined by o2-04, C6-01 (0.0 - 60.0%)

The drive automatically sets this parameter during Auto-Tuning.

Note:

The motor nameplate does not usually show the quantity of voltage drop. If you do not know the value of the motor leakage inductance, contact the motor manufacturer to receive a copy of the motor test report.

■ E2-07: Motor Saturation Coefficient 1

No. (Hex.)	Name	Description	Default (Range)
E2-07 (0314)	Motor Saturation Coefficient 1	<div style="display: flex; justify-content: space-between; font-size: 0.8em; font-weight: normal;"> V/f CL-V/f OLV CLV AOLV OLV/PM AOLV/PM CLV/PM EZOLV </div> <p>Sets the motor iron-core saturation coefficient at 50% of the magnetic flux.</p>	0.50 (0.00 - 0.50)

The drive uses this coefficient when it operates with constant output. The drive uses this coefficient when it operates the motor in the constant output range.

■ E2-08: Motor Saturation Coefficient 2

No. (Hex.)	Name	Description	Default (Range)
E2-08 (0315)	Motor Saturation Coefficient 2	<div style="display: flex; justify-content: space-between; font-size: 0.8em; font-weight: normal;"> V/f CL-V/f OLV CLV AOLV OLV/PM AOLV/PM CLV/PM EZOLV </div> <p>Sets the motor iron-core saturation coefficient at 75% of the magnetic flux.</p>	0.75 (E2-07 - 0.75)

The drive uses this coefficient when it operates with constant output. The drive uses this coefficient when it operates the motor in the constant output range.

■ E2-09: Motor Mechanical Loss

No. (Hex.)	Name	Description	Default (Range)
E2-09 (0316) Expert	Motor Mechanical Loss	<div style="display: flex; justify-content: space-between; font-size: 0.8em; font-weight: normal;"> V/f CL-V/f OLV CLV AOLV OLV/PM AOLV/PM CLV/PM EZOLV </div> <p>Sets the mechanical loss of the motor. It is set as a percentage of E2-11 [Motor Rated Power]. Usually it is not necessary to change this setting.</p>	0.0% (0.0 - 10.0%)

Adjust this parameter in these conditions. The drive adds the configured mechanical loss to the torque reference value as a torque compensation value:

- There is a large quantity of torque loss from motor bearing friction.
- There is a large quantity of torque loss in fans and pumps.

■ E2-10: Motor Iron Loss

No. (Hex.)	Name	Description	Default (Range)
E2-10 (0317)	Motor Iron Loss	<div style="display: flex; justify-content: space-between; font-size: 0.8em; font-weight: normal;"> V/f CL-V/f OLV CLV AOLV OLV/PM AOLV/PM CLV/PM EZOLV </div> <p>Sets the motor iron loss.</p>	Determined by o2-04, C6-01 (0 - 65535 W)

■ E2-11: Motor Rated Power

No. (Hex.)	Name	Description	Default (Range)
E2-11 (0318)	Motor Rated Power	<div style="display: flex; justify-content: space-between; font-size: 0.8em; font-weight: normal;"> V/f CL-V/f OLV CLV AOLV OLV/PM AOLV/PM CLV/PM EZOLV </div> <p>Sets the motor rated output in the units from o1-58 [Motor Power Unit Selection].</p>	Determined by o2-04, C6-01 (0.00 - 650.00 HP)

The drive automatically sets this parameter to the value input for “Motor Rated Power” during Auto-Tuning.

◆ E3: V/f Pattern for Motor 2

E3 parameters [V/f Pattern for Motor 2] set the control mode and V/f pattern used for motor 2.

Note:

V/f preset patterns equivalent to those set with E1-03 [V/f Pattern Selection] are not available for E3 parameters. Use E3-04 [Motor 2 Maximum Output Frequency] to E3-10 [Motor 2 Minimum Output Voltage] to manually set the V/f pattern.

■ Notes on Manually Setting V/f Patterns

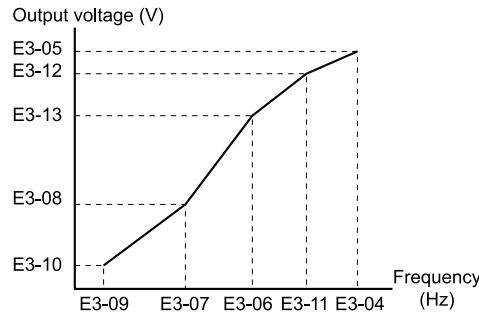

Figure 12.72 Motor 2 V/f Pattern Diagram

- To configure a linear V/f pattern at frequencies lower than E3-06 [Motor 2 Base Frequency], set E3-07 = E3-09 [Motor 2 Mid Point A Frequency = Motor 2 Minimum Output Frequency]. In this application, the drive ignores E1-08 [Mid Point A Voltage].
- Set the five frequencies as specified by these rules:
 $E3-09 \leq E3-07 < E3-06 \leq E3-11 \leq E3-04$ [Motor 2 Minimum Output Frequency ≤ Motor 2 Mid Point A Frequency < Motor 2 Base Frequency ≤ Motor 2 Mid Point B Frequency ≤ Motor 2 Maximum Output Frequency]
 Incorrect settings will trigger oPE10 [V/f Data Setting Error].
- If E3-11 = 0.0 Hz, the drive will ignore the V/f pattern settings.
- When you use A1-03 [Initialize Parameters] to initialize the drive, the drive will reset the manually set values for E3-04 to E3-13 [Motor 2 Base Voltage] to default values.

■ E3-01: Motor 2 Control Mode Selection

No. (Hex.)	Name	Description	Default (Range)
E3-01 (0319)	Motor 2 Control Mode Selection	<input checked="" type="radio"/> V/f <input type="radio"/> CL-V/f <input type="radio"/> OLV <input type="radio"/> CLV <input type="radio"/> AOLV <input type="radio"/> OLV/PM <input type="radio"/> AOLV/PM <input type="radio"/> CLV/PM <input type="radio"/> EZOLV Sets the control method for motor 2.	0 (0 - 3)

Note:

- When you change this setting, the drive will set all parameters that are dependent on this parameter to their default settings.
- Parameter L1-01 [Motor Overload (oL1) Protection] sets the protection operation of oL1 [Motor Overload] the same as Motor 1.
- When you use parameter A1-03 [Initialize Parameters] to initialize the drive, this parameter is not reset.

0 : V/f Control

1 : V/f Control with Encoder

2 : Open Loop Vector

3 : Closed Loop Vector

■ E3-04: Motor 2 Maximum Output Frequency

No. (Hex.)	Name	Description	Default (Range)
E3-04 (031A)	Motor 2 Maximum Output Frequency	<input checked="" type="radio"/> V/f <input type="radio"/> CL-V/f <input type="radio"/> OLV <input type="radio"/> CLV <input type="radio"/> AOLV <input type="radio"/> OLV/PM <input type="radio"/> AOLV/PM <input type="radio"/> CLV/PM <input type="radio"/> EZOLV Set the maximum output frequency for the motor 2 V/f pattern.	Determined by E3-01 (40.0 - 590.0 Hz)

■ E3-05: Motor 2 Maximum Output Voltage

No. (Hex.)	Name	Description	Default (Range)
E3-05 (031B)	Motor 2 Maximum Output Voltage	<div style="display: flex; justify-content: space-between; align-items: center;"> V/f CL-V/f OLV CLV AOLV OLV/PM AOLV/PM CLV/PM EZOLV </div> Sets the maximum output voltage for the motor 2 V/f pattern.	Determined by E3-01 (200 V Class: 0.0 - 255.0 V, 400 V Class: 0.0 - 510.0 V)

■ E3-06: Motor 2 Base Frequency

No. (Hex.)	Name	Description	Default (Range)
E3-06 (031C)	Motor 2 Base Frequency	<div style="display: flex; justify-content: space-between; align-items: center;"> V/f CL-V/f OLV CLV AOLV OLV/PM AOLV/PM CLV/PM EZOLV </div> Sets the base frequency for the motor 2 V/f pattern.	Determined by E3-01 (0.0 - E3-04)

■ E3-07: Motor 2 Mid Point A Frequency

No. (Hex.)	Name	Description	Default (Range)
E3-07 (031D)	Motor 2 Mid Point A Frequency	<div style="display: flex; justify-content: space-between; align-items: center;"> V/f CL-V/f OLV CLV AOLV OLV/PM AOLV/PM CLV/PM EZOLV </div> Sets a middle output frequency for the motor 2 V/f pattern.	Determined by E3-01 (0.0 - E3-04)

■ E3-08: Motor 2 Mid Point A Voltage

No. (Hex.)	Name	Description	Default (Range)
E3-08 (031E)	Motor 2 Mid Point A Voltage	<div style="display: flex; justify-content: space-between; align-items: center;"> V/f CL-V/f OLV CLV AOLV OLV/PM AOLV/PM CLV/PM EZOLV </div> Sets a middle output voltage for the motor 2 V/f pattern.	Determined by E3-01 (200 V Class: 0.0 - 255.0 V, 400 V Class: 0.0 - 510.0 V)

■ E3-09: Motor 2 Minimum Output Frequency

No. (Hex.)	Name	Description	Default (Range)
E3-09 (031F)	Motor 2 Minimum Output Frequency	<div style="display: flex; justify-content: space-between; align-items: center;"> V/f CL-V/f OLV CLV AOLV OLV/PM AOLV/PM CLV/PM EZOLV </div> Sets the minimum output frequency for the motor 2 V/f pattern.	Determined by E3-01 (0.0 - E3-04)

■ E3-10: Motor 2 Minimum Output Voltage

No. (Hex.)	Name	Description	Default (Range)
E3-10 (0320)	Motor 2 Minimum Output Voltage	<div style="display: flex; justify-content: space-between; align-items: center;"> V/f CL-V/f OLV CLV AOLV OLV/PM AOLV/PM CLV/PM EZOLV </div> Sets the minimum output voltage for the motor 2 V/f pattern.	Determined by E3-01 (200 V Class: 0.0 - 255.0 V, 400 V Class: 0.0 - 510.0 V)

■ E3-11: Motor 2 Mid Point B Frequency

No. (Hex.)	Name	Description	Default (Range)
E3-11 (0345) Expert	Motor 2 Mid Point B Frequency	<div style="display: flex; justify-content: space-between; align-items: center;"> V/f CL-V/f OLV CLV AOLV OLV/PM AOLV/PM CLV/PM EZOLV </div> Sets a middle output frequency for the motor 2 V/f pattern. Set this parameter to adjust the V/f pattern for the constant output range. Usually it is not necessary to change this parameter.	0.0 Hz (0.0 - E3-04)

Note:

- Set this parameter to 0.0 to disable the function.
- When you initialize the drive, this parameter is reset to the default value.

■ **E3-12: Motor 2 Mid Point B Voltage**

No. (Hex.)	Name	Description	Default (Range)
E3-12 (0346) Expert	Motor 2 Mid Point B Voltage	<div style="display: flex; justify-content: space-between; font-size: 0.8em;"> V/f CL-V/f OLV CLV AOLV OLV/PM AOLV/PM CLV/PM EZOLV </div> <p>Sets a middle output voltage for the motor 2 V/f pattern. Set this parameter to adjust the V/f pattern for the constant output range. Usually it is not necessary to change this parameter.</p>	0.0 V (200 V Class: 0.0 to 255.0 V, 400 V Class: 0.0 to 510.0 V)

Note:

- Set this parameter to 0.0 to disable the function.
- When you initialize the drive, this parameter is reset to the default value.
- The setting value changes automatically when you do Auto-Tuning (rotational and stationary 1 or 2).

■ **E3-13: Motor 2 Base Voltage**

No. (Hex.)	Name	Description	Default (Range)
E3-13 (0347) Expert	Motor 2 Base Voltage	<div style="display: flex; justify-content: space-between; font-size: 0.8em;"> V/f CL-V/f OLV CLV AOLV OLV/PM AOLV/PM CLV/PM EZOLV </div> <p>Sets the base voltage for the motor 2 V/f pattern. Set this parameter to adjust the V/f pattern for the constant output range. Usually it is not necessary to change this parameter.</p>	0.0 V (200 V Class: 0.0 to 255.0 V, 400 V Class: 0.0 to 510.0 V)

Note:

- When you initialize the drive, this parameter is reset to the default value.
- The setting value changes automatically when you do Auto-Tuning (rotational and stationary 1 or 2).

◆ **E4: Motor 2 Parameters**

E4 parameters [Motor 2 Parameters] set induction motor data. To switch drive operation from one motor to a different motor, configure motor 2.

Auto-Tuning automatically sets the *E4 parameters* to the best values for the application. If you cannot do Auto-Tuning, set the *E4 parameters* manually.

Note:

E3-xx and *E4-xx* are available when *H1-xx = 16 [MFDI Function Select = Motor 2 Selection]*.

■ **E4-01: Motor 2 Rated Current**

No. (Hex.)	Name	Description	Default (Range)
E4-01 (0321)	Motor 2 Rated Current	<div style="display: flex; justify-content: space-between; font-size: 0.8em;"> V/f CL-V/f OLV CLV AOLV OLV/PM AOLV/PM CLV/PM EZOLV </div> <p>Sets the motor rated current for motor 2 in amps.</p>	Determined by o2-04, C6-01 (10% to 200% of the drive rated current)

Note:

- If $E4-01 \leq E4-03$ [*Motor 2 Rated No-Load Current*], the drive will detect *oPE02 [Parameter Range Setting Error]* will be detected.
- The default settings and setting ranges are in these units:
 –0.01 A: 2004 to 2042, 4002 to 4023
 –0.1 A: 2056 to 2415, 4031 to 4720

The value set for *E4-01* becomes the reference value for motor protection, the torque limit, and torque control. Enter the motor rated current written on the motor nameplate. Auto-Tuning automatically sets the value of *E4-01* to the value input for [Motor Rated Current].

■ **E4-02: Motor 2 Rated Slip**

No. (Hex.)	Name	Description	Default (Range)
E4-02 (0322)	Motor 2 Rated Slip	<div style="display: flex; justify-content: space-between; font-size: 0.8em;"> V/f CL-V/f OLV CLV AOLV OLV/PM AOLV/PM CLV/PM EZOLV </div> <p>Sets the motor rated slip for motor 2.</p>	Determined by o2-04, C6-01 (0.000 - 20.000 Hz)

The value set in *E4-02* becomes the base slip compensation value. The drive sets this parameter during Rotational Auto-Tuning and Stationary Auto-Tuning. If you cannot do Auto-Tuning, use the information written on the motor nameplate and this formula to calculate the motor rated slip:

$$E4-02 = f - (n \times p) / 120$$

- f: Motor rated frequency (Hz)
- n: Rated motor speed (min^{-1} (r/min))
- p: Number of motor poles

■ E4-03: Motor 2 Rated No-Load Current

No. (Hex.)	Name	Description	Default (Range)
E4-03 (0323)	Motor 2 Rated No-Load Current	<div style="display: flex; justify-content: space-between; font-size: 0.8em; font-weight: normal;"> V/f CL-V/f OLV CLV AOLV OLV/PM AOLV/PM CLV/PM EZOLV </div> Sets the no-load current for motor 2 in amps when operating at the rated frequency and the no-load voltage.	Determined by o2-04, C6-01 (Less than 0 - E4-01)

Note:

When the drive model changes, the display units for this parameter also change.

- 0.01 A: 2004 to 2042, 4002 to 4023
- 0.1 A: 2056 to 2415, 4031 to 4720

You can also manually enter the motor no-load current shown on the motor test report to *E4-03*. Contact the motor manufacturer to receive a copy of the motor test report.

Note:

The default setting of the no-load current is for a 4-pole motor recommended by Yaskawa.

■ E4-04: Motor 2 Motor Poles

No. (Hex.)	Name	Description	Default (Range)
E4-04 (0324)	Motor 2 Motor Poles	<div style="display: flex; justify-content: space-between; font-size: 0.8em; font-weight: normal;"> V/f CL-V/f OLV CLV AOLV OLV/PM AOLV/PM CLV/PM EZOLV </div> Sets the number of poles for motor 2.	4 (2 - 120)

Auto-Tuning automatically sets *E4-04* to the value input for [Number of Motor Poles].

■ E4-05: Motor 2 Line-to-Line Resistance

No. (Hex.)	Name	Description	Default (Range)
E4-05 (0325)	Motor 2 Line-to-Line Resistance	<div style="display: flex; justify-content: space-between; font-size: 0.8em; font-weight: normal;"> V/f CL-V/f OLV CLV AOLV OLV/PM AOLV/PM CLV/PM EZOLV </div> Sets the line-to-line resistance for the motor 2 stator windings.	Determined by o2-04, C6-01 (0.000 - 65.000 Ω)

Note:

This value is the line-to-line resistance for motor 2. Do not set this parameter with the per-phase resistance.

The drive automatically calculates this value when Auto-Tuning completes successfully. If you cannot do Auto-Tuning, get the test report from the motor manufacturer. To calculate the motor line-to-line resistance, use the information shown on the motor nameplate with one of these formulas:

- E-type insulation: the resistance value (Ω) shown on the test report at $75\text{ }^\circ\text{C} \times 0.92$
- B-type insulation: the resistance value (Ω) shown on the test report at $75\text{ }^\circ\text{C} \times 0.92$
- F-type insulation: the resistance value (Ω) shown on the test report at $115\text{ }^\circ\text{C} \times 0.87$

■ E4-06: Motor 2 Leakage Inductance

No. (Hex.)	Name	Description	Default (Range)
E4-06 (0326)	Motor 2 Leakage Inductance	<div style="display: flex; justify-content: space-between; font-size: 0.8em; font-weight: normal;"> V/f CL-V/f OLV CLV AOLV OLV/PM AOLV/PM CLV/PM EZOLV </div> Sets the voltage drop from motor 2 leakage inductance as a percentage of Motor Rated Voltage when motor 2 operates at the rated frequency and rated current.	Determined by o2-04, C6-01 (0.0 - 60.0%)

The drive sets this parameter during Rotational Auto-Tuning and Stationary Auto-Tuning.

Note:

You cannot usually find the quantity of voltage drop on the motor nameplate. If you do not know the value of the motor 2 leakage inductance, get the test report from the motor manufacturer.

■ E4-07: Motor 2 Saturation Coefficient 1

No. (Hex.)	Name	Description	Default (Range)
E4-07 (0343)	Motor 2 Saturation Coefficient 1	<div style="display: flex; justify-content: space-between; font-size: 0.8em;"> V/f CL-V/f OLV CLV AOLV OLV/PM AOLV/PM CLV/PM EZOLV </div> Sets the motor 2 iron-core saturation coefficient at 50% of the magnetic flux.	0.50 (0.00 - 0.50)

The drive sets this parameter during Rotational Auto-Tuning. The drive uses this value when it operates the motor in the constant output range.

■ E4-08: Motor 2 Saturation Coefficient 2

No. (Hex.)	Name	Description	Default (Range)
E4-08 (0344)	Motor 2 Saturation Coefficient 2	<div style="display: flex; justify-content: space-between; font-size: 0.8em;"> V/f CL-V/f OLV CLV AOLV OLV/PM AOLV/PM CLV/PM EZOLV </div> Sets the motor 2 iron-core saturation coefficient at 75% of the magnetic flux.	0.75 (E4-07 - 0.75)

The drive sets this parameter during Rotational Auto-Tuning. The drive uses this value when it operates the motor in the constant output range.

■ E4-09: Motor 2 Mechanical Loss

No. (Hex.)	Name	Description	Default (Range)
E4-09 (033F) Expert	Motor 2 Mechanical Loss	<div style="display: flex; justify-content: space-between; font-size: 0.8em;"> V/f CL-V/f OLV CLV AOLV OLV/PM AOLV/PM CLV/PM EZOLV </div> Sets the mechanical loss of motor 2. It is set as a percentage of <i>E4-11 [Motor 2 Rated Power]</i> . Usually it is not necessary to change this setting.	0.0% (0.0 - 10.0%)

Adjust this parameter in these conditions. The drive adds the configured mechanical loss to the torque reference value as a torque compensation value:

- There is a large quantity of torque loss from motor bearing friction.
- There is a large quantity of torque loss in fans and pumps.

■ E4-10: Motor 2 Iron Loss

No. (Hex.)	Name	Description	Default (Range)
E4-10 (0340)	Motor 2 Iron Loss	<div style="display: flex; justify-content: space-between; font-size: 0.8em;"> V/f CL-V/f OLV CLV AOLV OLV/PM AOLV/PM CLV/PM EZOLV </div> Sets the motor iron loss for motor 2.	Determined by o2-04, C6-01 (0 - 65535 W)

■ E4-11: Motor 2 Rated Power

No. (Hex.)	Name	Description	Default (Range)
E4-11 (0327)	Motor 2 Rated Power	<div style="display: flex; justify-content: space-between; font-size: 0.8em;"> V/f CL-V/f OLV CLV AOLV OLV/PM AOLV/PM CLV/PM EZOLV </div> Sets the motor rated power in the units from <i>o1-58 [Motor Power Unit Selection]</i> .	Determined by o2-04, C6-01 (0.00 - 650.00 HP)

Auto-Tuning automatically sets this parameter to the value input for [Motor Rated Power].

◆ E5: PM Motor Settings

E5 parameters are used to set PM motor data.

Set *E5-01* to the motor code when using PM motors recommended by Yaskawa. *E5* and other related motor parameters will be automatically set to the optimal values.

Perform Auto-Tuning for all other PM motors. If information from motor nameplates or test reports is available, the *E5 parameters* can be manually entered.

Note:

- The keypad displays *E5-xx* only when *A1-02 = 5, 6, 7 [Control Method Selection = OLV/PM, AOLV/PM, CLV/PM]*.
- *E5-xx parameters* are not reset when the drive is initialized using parameter *A1-03 [Initialize Parameters]*.

■ E5-01: PM Motor Code Selection

No. (Hex.)	Name	Description	Default (Range)
E5-01 (0329)	PM Motor Code Selection	<div style="display: flex; justify-content: space-between; font-size: small;"> V/f CL-V/f OLV CLV AOLV OLV/PM AOLV/PM CLV/PM EZOLV </div> <p>Sets the motor code for Yaskawa PM motors. The drive uses the motor code to automatically set some parameters to their correct settings.</p>	FFFF (0000 - FFFF)

Note:

- If the drive hunts or shows an alarm after you use a motor code, use the keypad to enter the value shown on the nameplate to *E5-xx*.
- When you use a PM motor other than a Yaskawa SMRA, SSR1, or SST4 series, set *E5-01* = *FFFF*.

Figure 12.73 gives information about the motor code setting digits.

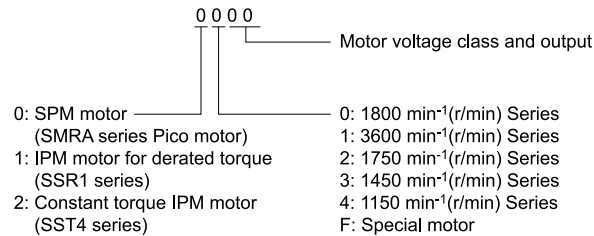

Figure 12.73 PM Motor Code

■ E5-02: PM Motor Rated Power

No. (Hex.)	Name	Description	Default (Range)
E5-02 (032A)	PM Motor Rated Power	<div style="display: flex; justify-content: space-between; font-size: small;"> V/f CL-V/f OLV CLV AOLV OLV/PM AOLV/PM CLV/PM EZOLV </div> <p>Sets the PM motor rated output in the units set in <i>o1-58</i> [Motor Power Unit Selection].</p>	Determined by <i>o2-04</i> , <i>C6-01</i> (0.10 - 650.00 HP)

The drive will automatically set this parameter the next time you do Auto-Tuning.

- PM Motor Parameter Settings
- PM Stationary Auto-Tuning
- PM Rotational Auto-Tuning

■ E5-03: PM Motor Rated Current (FLA)

No. (Hex.)	Name	Description	Default (Range)
E5-03 (032B)	PM Motor Rated Current (FLA)	<div style="display: flex; justify-content: space-between; font-size: small;"> V/f CL-V/f OLV CLV AOLV OLV/PM AOLV/PM CLV/PM EZOLV </div> <p>Sets the PM motor rated current (FLA).</p>	Determined by <i>o2-04</i> , <i>C6-01</i> (10% to 200% of the drive rated current)

Note:

When the drive model changes, the display units for this parameter also change.

- 0.01 A: models 2004 to 2042, 4002 to 4023
- 0.1 A: models 2056 to 2415, 4031 to 4720

After you do these types of Auto-Tuning, the drive automatically will set *E5-03* to the value input for “PM Motor Rated Current”:

- PM Motor Parameter Settings
- PM Stationary Auto-Tuning
- PM StaTun for Stator Resistance
- PM Rotational Auto-Tuning

■ E5-04: PM Motor Pole Count

No. (Hex.)	Name	Description	Default (Range)
E5-04 (032C)	PM Motor Pole Count	<div style="display: flex; justify-content: space-between; font-size: small;"> V/f CL-V/f OLV CLV AOLV OLV/PM AOLV/PM CLV/PM EZOLV </div> <p>Sets the number of PM motor poles.</p>	4 (2 - 120)

12.6 E: Motor Parameters

Note:

- When $A1-02 = 7$ [Control Method Selection = CLV/PM], the maximum value is 120.
- When $A1-02 = 5, 6$ or 8 [OLV/PM, AOLV/PM or EZOLV], the maximum value is 48.

These types of Auto-Tuning will automatically set this parameter to the value of [Number of Motor Poles]:

- PM Motor Parameter Settings
- PM Stationary Auto-Tuning
- PM Rotational Auto-Tuning

■ E5-05: PM Motor Resistance (ohms/phase)

No. (Hex.)	Name	Description	Default (Range)
E5-05 (032D)	PM Motor Resistance (ohms/phase)	<div style="display: flex; justify-content: space-between; font-size: small;"> V/f CL-V/f OLV CLV AOLV OLV/PM AOLV/PM CLV/PM EZOLV </div> Sets the resistance per phase of a PM motor. Set 50% of the line-to-line resistance.	0.100 Ω (0.000 - 65.000 Ω)

PM motor Auto-Tuning automatically sets this parameter to the value of [PM Motor Stator Resistance].

Note:

Do not change the setting calculated by Auto-Tuning unless it is necessary.

■ E5-06: PM d-axis Inductance (mH/phase)

No. (Hex.)	Name	Description	Default (Range)
E5-06 (032E)	PM d-axis Inductance (mH/phase)	<div style="display: flex; justify-content: space-between; font-size: small;"> V/f CL-V/f OLV CLV AOLV OLV/PM AOLV/PM CLV/PM EZOLV </div> Sets the PM motor d-axis inductance.	1.00 mH (0.00 - 300.00 mH)

PM motor Auto-Tuning automatically sets this parameter to the value of [PM Motor d-Axis Inductance].

Note:

Do not change the setting calculated by Auto-Tuning unless it is necessary.

■ E5-07: PM q-axis Inductance (mH/phase)

No. (Hex.)	Name	Description	Default (Range)
E5-07 (032F)	PM q-axis Inductance (mH/phase)	<div style="display: flex; justify-content: space-between; font-size: small;"> V/f CL-V/f OLV CLV AOLV OLV/PM AOLV/PM CLV/PM EZOLV </div> Sets the PM motor q-axis inductance.	1.00 mH (0.00 - 600.00 mH)

PM motor Auto-Tuning automatically sets this parameter to the value of [PM Motor q-Axis Inductance].

Note:

Do not change the setting calculated by Auto-Tuning unless it is necessary.

■ E5-09: PM Back-EMF Vpeak (mV/(rad/s))

No. (Hex.)	Name	Description	Default (Range)
E5-09 (0331)	PM Back-EMF Vpeak (mV/(rad/s))	<div style="display: flex; justify-content: space-between; font-size: small;"> V/f CL-V/f OLV CLV AOLV OLV/PM AOLV/PM CLV/PM EZOLV </div> Sets the peak value of PM motor induced voltage.	0.0 mV/(rad/sec) (0.0 - 2000.0 mV/(rad/s))

Set this parameter when you use an IPM motor with derated torque (SSR1-series) or an IPM motor with constant torque (SST4-series).

PM motor Auto-Tuning automatically sets this parameter to the value of [Back-EMF Voltage Constant (Ke)].

When $E5-01 = FFFF$, only set $E5-09$ or $E5-24$ [PM Back-EMF L-L V_{rms} (mV/rpm)] as the induced voltage constant.

Note:

When you set this parameter, also set $E5-24 = 0.0$. The drive will detect $oPE08$ [Parameter Selection Error] in these conditions:

- $E5-09 = 0.0$ and $E5-24 = 0.0$
- $E5-09 \neq 0.0$ and $E5-24 \neq 0.0$

■ E5-11: Encoder Z-Pulse Offset

No. (Hex.)	Name	Description	Default (Range)
E5-11 (0333)	Encoder Z-Pulse Offset	<div style="display: flex; justify-content: space-between; font-size: small;"> V/f CL-V/f OLV CLV AOLV OLV/PM AOLV/PM CLV/PM EZOLV </div> Sets the encoder Z-pulse offset.	0.0 degrees (-180.0 - +180.0 degrees)

The drive uses the PM motor parameter settings and PM Stationary Auto-Tuning to set *E5-11* to the value input for “Encoder Z-Pulse Offset” automatically. The drive uses Z Pulse Offset Tuning or the Rotational Auto-Tuning to set *E5-11*.

■ E5-24: PM Back-EMF L-L Vrms (mV/rpm)

No. (Hex.)	Name	Description	Default (Range)
E5-24 (0353)	PM Back-EMF L-L Vrms (mV/rpm)	<div style="display: flex; justify-content: space-between; font-size: small;"> V/f CL-V/f OLV CLV AOLV OLV/PM AOLV/PM CLV/PM EZOLV </div> Sets the RMS value for PM motor line voltage.	0.1 mV/min ⁻¹ (0.0 - 6500.0 mV/min ⁻¹)

Set this parameter when you use an SPM motor (SMRA-Series Pico motor).

PM motor Auto-Tuning automatically sets this parameter to the value of [Back-EMF Voltage Constant (Ke)].

When *E5-01* = *FFFF*, only set *E5-09* [PM Back-EMF *Vpeak* (mV/(rad/s))] or *E5-24* as the induced voltage constant.

Note:

When you set this parameter, also set *E5-09* = 0.0. The drive will detect *oPE08* [Parameter Selection Error] in these conditions:

- *E5-09* = 0.0 and *E5-24* = 0.0
- *E5-09* ≠ 0.0 and *E5-24* ≠ 0.0

■ E5-25: Polarity Estimation Timeout

No. (Hex.)	Name	Description	Default (Range)
E5-25 (035E) Expert	Polarity Estimation Timeout	<div style="display: flex; justify-content: space-between; font-size: small;"> V/f CL-V/f OLV CLV AOLV OLV/PM AOLV/PM CLV/PM EZOLV </div> Sets the function that switches polarity for initial polarity estimation. Usually it is not necessary to change this setting.	0 (0, 1)

When “Sd = 1” is shown on the motor nameplate or test report for Yaskawa motors, set this parameter to 1.

0 : Disabled

1 : Enabled

◆ E9: Motor Setting

E9 parameters set SynRM motors. Set these parameters to derate torque applications when a high level of responsiveness and accurate speed control are not necessary. Auto-Tuning the drive will automatically set the *E9 parameters*.

If you cannot do EZ Tuning, you can also manually set the *E9 parameters*.

■ E9-01: Motor Type Selection

No. (Hex.)	Name	Description	Default (Range)
E9-01 (11E4)	Motor Type Selection	<div style="display: flex; justify-content: space-between; font-size: small;"> V/f CL-V/f OLV CLV AOLV OLV/PM AOLV/PM CLV/PM EZOLV </div> Sets the type of motor.	0 (0 to 2)

EZ Tuning automatically sets this parameter to the value of [Motor Type Selection].

0 : Induction (IM)

1 : Permanent Magnet (PM)

2 : Synchronous Reluctance (SynRM)

■ E9-02: Maximum Speed

No. (Hex.)	Name	Description	Default (Range)
E9-02 (11E5)	Maximum Speed	<div style="display: flex; justify-content: space-between; font-size: 0.8em;"> V/f CL-V/f OLV CLV AOLV OLV/PM AOLV/PM CLV/PM EZOLV </div> Sets the maximum speed of the motor.	Determined by E9-01 (40.0 - 120.0 Hz)

Note:

The unit of measure changes when the setting of *o1-04 [V/f Pattern Display Unit]*.

EZ Tuning automatically sets this parameter to the value of [Motor Max Revolutions].

■ E9-03: Rated Speed

No. (Hex.)	Name	Description	Default (Range)
E9-03 (11E6)	Rated Speed	<div style="display: flex; justify-content: space-between; font-size: 0.8em;"> V/f CL-V/f OLV CLV AOLV OLV/PM AOLV/PM CLV/PM EZOLV </div> Sets the rated rotation speed of the motor.	Determined by E9-01 (100 - 7200 min ⁻¹)

EZ Tuning automatically sets this parameter to the value of [Rated Speed].

Note:

Set *E9-01 = 0 [Motor Type Selection = Induction (IM)]* before you set this parameter.

■ E9-04: Base Frequency

No. (Hex.)	Name	Description	Default (Range)
E9-04 (11E7)	Base Frequency	<div style="display: flex; justify-content: space-between; font-size: 0.8em;"> V/f CL-V/f OLV CLV AOLV OLV/PM AOLV/PM CLV/PM EZOLV </div> Sets the rated frequency of the motor.	Determined by E9-01 (40.0 - 120.0 Hz)

Note:

The unit of measure changes when the setting of *o1-04 [V/f Pattern Display Unit]*.

EZ Tuning automatically sets this parameter to the value of [Base Frequency].

■ E9-05: Base Voltage

No. (Hex.)	Name	Description	Default (Range)
E9-05 (11E8)	Motor Rated Voltage	<div style="display: flex; justify-content: space-between; font-size: 0.8em;"> V/f CL-V/f OLV CLV AOLV OLV/PM AOLV/PM CLV/PM EZOLV </div> Sets the rated voltage of the motor.	200 V Class: 230.0 V, 400 V: 460.0 V (200 V Class: 0.0 - 255.0 V, 400 V Class: 0.0 - 510.0 V)

EZ Tuning automatically sets this parameter to the value of [Base Voltage].

■ E9-06: Motor Rated Current (FLA)

No. (Hex.)	Name	Description	Default (Range)
E9-06 (11E9)	Motor Rated Current (FLA)	<div style="display: flex; justify-content: space-between; font-size: 0.8em;"> V/f CL-V/f OLV CLV AOLV OLV/PM AOLV/PM CLV/PM EZOLV </div> Sets the motor rated current in amps.	Determined by E9-01 and o2-04 (10% to 200% of the drive rated current)

Note:

When the drive model changes, the display units for this parameter also change.

- 0.01 A: models 2004 to 2042, 4002 to 4023
- 0.1 A: models 2056 to 2415, 4031 to 4720

The value set for *E9-06* becomes the reference value for motor protection. Enter the motor rated current shown on the motor nameplate. Auto-Tuning the drive will automatically set *E9-06* to the value input for "Motor Rated Current".

■ E9-07: Motor Rated Power

No. (Hex.)	Name	Description	Default (Range)
E9-07 (11EA)	Motor Rated Power	<div style="display: flex; justify-content: space-between; font-size: 0.8em; font-weight: normal;"> V/f CL-V/f OLV CLV AOLV OLV/PM AOLV/PM CLV/PM EZOLV </div> Sets the motor rated output in the units from 01-58 [Motor Power Unit Selection].	Determined by E9-02 and o2-04 (0.00 - 650.00 kW)

Auto-Tuning automatically sets this parameter to the value of [Motor Rated Power (kW)].

■ E9-08: Motor Pole Count

No. (Hex.)	Name	Description	Default (Range)
E9-08 (11EB)	Motor Pole Count	<div style="display: flex; justify-content: space-between; font-size: 0.8em; font-weight: normal;"> V/f CL-V/f OLV CLV AOLV OLV/PM AOLV/PM CLV/PM EZOLV </div> Sets the number of motor poles.	4 (2 to 120)

Auto-Tuning automatically sets this parameter to the value of [Number of Motor Poles].

■ E9-09: Motor Rated Slip

No. (Hex.)	Name	Description	Default (Range)
E9-09 (11EC)	Motor Rated Slip	<div style="display: flex; justify-content: space-between; font-size: 0.8em; font-weight: normal;"> V/f CL-V/f OLV CLV AOLV OLV/PM AOLV/PM CLV/PM EZOLV </div> Sets the motor rated slip.	0.000 Hz (0.000 - 20.000 Hz)

The setting value of this parameter is the slip compensation reference value.

The drive uses the setting values of E9-03, E9-04, and E9-08 to calculate this parameter. When Motor Rated Slip = 0, Auto-Tuning automatically sets this parameter to the value of [Motor Rated Slip].

Note:

Set E9-01 = 0 [Motor Type Selection = Induction (IM)] before you set this parameter.

■ E9-10: Motor Line-to-Line Resistance

No. (Hex.)	Name	Description	Default (Range)
E9-10 (11ED)	Motor Line-to-Line Resistance	<div style="display: flex; justify-content: space-between; font-size: 0.8em; font-weight: normal;"> V/f CL-V/f OLV CLV AOLV OLV/PM AOLV/PM CLV/PM EZOLV </div> Sets the line-to-line resistance for the motor stator windings.	Determined by o2-04 (0.000 - 65.000 Ω)

Note:

This value is the motor line-to-line resistance. Do not set this parameter with the per-phase resistance.

Stationary Auto-Tuning automatically sets this parameter. If you cannot do Stationary Auto-Tuning, use the test report from the motor manufacturer. You can calculate the motor line-to-line resistance with one of these formulas:

- E-type insulation: the resistance value (Ω) shown on the test report at 75 °C × 0.92
- B-type insulation: the resistance value (Ω) shown on the test report at 75 °C × 0.92
- F-type insulation: the resistance value (Ω) shown on the test report at 115 °C × 0.87

12.7 F: Options

F parameters are used to set option cards, which function as interfaces for encoders, analog I/O, digital I/O, and fieldbus communication.

◆ F1: Encoder Option Setup

F1 parameters are used to set the operation of and protective function for the encoder option card. The following table lists the setting parameters available for each option card.

Refer to the instruction manual packaged with the encoder option card for more information on installing, wiring, and setting the encoder option cards.

WARNING! Sudden Movement Hazard. Do test runs and examine the drive to make sure that the command references are correct. If you set the command reference incorrectly, it can cause damage to the drive or serious injury or death.

WARNING! Sudden Movement Hazard. Make sure that the host controller circuitry has correct safety design that will let you keep control of the motor if the drive loses speed feedback. If you do not have control of the motor, it can cause serious injury or death.

Table 12.43 Encoder Option Card Setting Parameters

Setting Parameter	Encoder Option Card			
	PG-B3	PG-X3	PG-F3	PG-RT3
F1-01	x	x	x	-
F1-02	x	x	x	x
F1-03	x	x	x	x
F1-04	x	x	x	x
F1-05	x	x	x	x
F1-06	x	x	x	-
F1-08	x	x	x	x
F1-09	x	x	x	x
F1-10	x	x	x	x
F1-11	x	x	x	x
F1-12 *1	x	x	-	-
F1-13 *1	x	x	-	-
F1-14	x	x	x	x
F1-18	x	x	x	x
F1-19	x	x	x	x
F1-20	-	x	x	-
F1-21	x	x	-	-
F1-30	x	x	-	-
F1-31 *2	x	x	-	-
F1-32 *2	x	x	-	-
F1-33 *1 *2	x	x	-	-
F1-34 *1 *2	x	x	-	-
F1-35 *2	x	x	-	-
F1-36	-	x	-	-
F1-37 *2	x	x	-	-
F1-50	-	-	x	-
F1-51	-	-	x	-

Setting Parameter	Encoder Option Card			
	PG-B3	PG-X3	PG-F3	PG-RT3
F1-52	-	-	x	-
Number of cards that can be installed in a drive	2	2	1	1

*1 Parameters set when using the Closed Loop V/f Control method.

*2 Parameters to set an option card connected to CN5-B.

■ F1-01: Encoder 1 Pulse Count (PPR)

No. (Hex.)	Name	Description	Default (Range)
F1-01 (0380)	Encoder 1 Pulse Count (PPR)	V/f CL-V/f OLV CLV AOLV OLV/PM AOLV/PM CLV/PM EZOLV Sets the number of output pulses for each motor revolution.	1024 ppr (1 - 60000 ppr)

■ F1-02: Encoder Signal Loss Detect Sel

No. (Hex.)	Name	Description	Default (Range)
F1-02 (0381)	Encoder Signal Loss Detect Sel	V/f CL-V/f OLV CLV AOLV OLV/PM AOLV/PM CLV/PM EZOLV Sets the method to stop the motor or let the motor continue operating when the drive detects <i>PGo</i> [Encoder (PG) Feedback Loss].	1 (0 - 4)

If the drive does not detect output pulses from the encoder for the time set in *F1-14* [Encoder Open-Circuit Detect Time], it will trigger *PGo*.

Note:

- Motor speed and load conditions can cause *ov* [Overvoltage] and *oC* [Overcurrent] faults.
- In AOLV control, set *n4-72 = 1* [Speed Feedback Mode = With Encoder].

0 : Ramp to Stop

The drive ramps the motor to stop in the deceleration time. Fault relay output terminal MA-MC turns ON, and MB-MC turns OFF.

1 : Coast to Stop

The output turns off and the motor coasts to stop. Fault relay output terminal MA-MC turns ON, and MB-MC turns OFF.

2 : Fast Stop (Use C1-09)

The drive stops the motor in the deceleration time set in *C1-09* [Fast Stop Time]. Fault relay output terminal MA-MC turns ON, and MB-MC turns OFF.

3 : Alarm Only

The keypad shows *PGo* and the drive continues operation. Only use this setting in special conditions to prevent damage to the motor and machinery. The output terminal set for *Alarm* [H2-01 to H2-03 = 10] activates.

4 : No Alarm Display

The drive continues operation and does not show *PGo* on the keypad. Only use this setting in special conditions to prevent damage to the motor and machinery.

■ F1-03: Overspeed Detection Selection

No. (Hex.)	Name	Description	Default (Range)
F1-03 (0382)	Overspeed Detection Selection	V/f CL-V/f OLV CLV AOLV OLV/PM AOLV/PM CLV/PM EZOLV Sets the method to stop the motor or let the motor continue operating when the drive detects <i>oS</i> [Overspeed].	1 (0 - 3)

When the motor speed is more than the value set in *F1-08* [Overspeed Detection Level] for longer than the time set in *F1-09* [Overspeed Detection Delay Time], the drive will detect *oS*.

0 : Ramp to Stop

The drive ramps the motor to stop in the deceleration time. Fault relay output terminal MA-MC turns ON, and MB-MC turns OFF.

1 : Coast to Stop

The output turns off and the motor coasts to stop. Fault relay output terminal MA-MC turns ON, and MB-MC turns OFF.

2 : Fast Stop (Use C1-09)

The drive stops the motor in the deceleration time set in *C1-09 [Fast Stop Time]*. Fault relay output terminal MA-MC turns ON, and MB-MC turns OFF.

3 : Alarm Only

The keypad shows *oS* and the drive continues operation. Only use this setting in special conditions to prevent damage to the motor and machinery. The output terminal set for *Alarm [H2-01 to H2-03 = 10]* activates.

Note:

When *A1-02 = 6 [Control Method Selection = AOLV/PM]*, the drive will automatically set *F1-03 = 1 [Coast to Stop]*. You cannot change this value.

■ F1-04: Speed Deviation Detection Select

No. (Hex.)	Name	Description	Default (Range)
F1-04 (0383)	Speed Deviation Detection Select	<div style="display: flex; justify-content: space-between; align-items: center;"> V/f CL-V/f OLV CLV AOLV OLV/PM AOLV/PM CLV/PM EZOLV </div> <p>Sets the method to stop the motor or let the motor continue operating when the drive detects <i>dEv</i> [Speed Deviation].</p>	3 (0 - 3)

When the difference between the frequency reference and the motor speed is more than the value set in *F1-10 [Speed Deviation Detection Level]* for longer than the time set in *F1-11 [Speed Deviation Detect DelayTime]*, the drive will detect *dEv*.

0 : Ramp to Stop

The drive ramps the motor to stop in the deceleration time. Fault relay output terminal MA-MC turns ON, and MB-MC turns OFF.

1 : Coast to Stop

The output turns off and the motor coasts to stop. Fault relay output terminal MA-MC turns ON, and MB-MC turns OFF.

2 : Fast Stop (Use C1-09)

The drive stops the motor in the deceleration time set in *C1-09 [Fast Stop Time]*. Fault relay output terminal MA-MC turns ON, and MB-MC turns OFF.

3 : Alarm Only

The keypad shows *dEv* and the drive continues operation. Only use this setting in special conditions to prevent damage to the motor and machinery. The output terminal set for *Alarm [H2-01 to H2-03 = 10]* activates.

■ F1-05: Encoder 1 Rotation Selection

No. (Hex.)	Name	Description	Default (Range)
F1-05 (0384)	Encoder 1 Rotation Selection	<div style="display: flex; justify-content: space-between; align-items: center;"> V/f CL-V/f OLV CLV AOLV OLV/PM AOLV/PM CLV/PM EZOLV </div> <p>Sets the output sequence for the A and B pulses from the encoder, assuming that the motor is operating in the forward direction.</p>	Determined by A1-02 (0, 1)

Refer to the option card installation manual for more information about how to set the encoder pulse output sequence and make sure that it is correct.

0 : Pulse A leads in FWD Direction

1 : Pulse B leads in FWD Direction

■ F1-06: Encoder 1 Pulse Monitor Scaling

No. (Hex.)	Name	Description	Default (Range)
F1-06 (0385)	Encoder 1 Pulse Monitor Scaling	<div style="display: flex; justify-content: space-between; font-size: 0.8em;"> V/f CL-V/f OLV CLV AOLV OLV/PM AOLV/PM CLV/PM EZOLV </div> <p>Sets the ratio between the pulse input and the pulse output of the encoder as a 3-digit number. The first digit is the numerator and the second and third digits set the denominator.</p>	001 (001 - 032, 102 - 132 (1 - 1/32))

When the setting value is a 3-digit value (xyz), the dividing ratio is $(1 + x)/yz$

For example, when $F1-06 = 032$, the dividing ratio is $1/32$.

Note:

When you use a single-pulse encoder, the dividing ratio for the monitor signal is 1:1

■ F1-08: Overspeed Detection Level

No. (Hex.)	Name	Description	Default (Range)
F1-08 (0387)	Overspeed Detection Level	<div style="display: flex; justify-content: space-between; font-size: 0.8em;"> V/f CL-V/f OLV CLV AOLV OLV/PM AOLV/PM CLV/PM EZOLV </div> <p>Sets the detection level of oS [Overspeed] as a percentage when the maximum output frequency is 100%.</p>	115% (0 - 120%)

When the motor speed is more than the value set in $F1-08$ for longer than the time set in $F1-09$ [Overspeed Detection Delay Time], the drive will detect oS .

■ F1-09: Overspeed Detection Delay Time

No. (Hex.)	Name	Description	Default (Range)
F1-09 (0388)	Overspeed Detection Delay Time	<div style="display: flex; justify-content: space-between; font-size: 0.8em;"> V/f CL-V/f OLV CLV AOLV OLV/PM AOLV/PM CLV/PM EZOLV </div> <p>Sets the length of time that the speed feedback must be more than the $F1-08$ level to cause oS [Overspeed].</p>	Determined by A1-02 (0.0 - 2.0 s)

When the motor speed is more than the value set in $F1-08$ [Overspeed Detection Level] for longer than the time set in $F1-09$, the drive will detect oS .

■ F1-10: Speed Deviation Detection Level

No. (Hex.)	Name	Description	Default (Range)
F1-10 (0389)	Speed Deviation Detection Level	<div style="display: flex; justify-content: space-between; font-size: 0.8em;"> V/f CL-V/f OLV CLV AOLV OLV/PM AOLV/PM CLV/PM EZOLV </div> <p>Sets the detection level of dEv [Speed Deviation] as a percentage when the maximum output frequency is 100%.</p>	10% (0 - 50%)

When the speed deviation between the frequency reference and the actual motor speed is more than the value set in $F1-10$ for longer than the time set in $F1-11$ [Speed Deviation Detect DelayTime], the drive will detect dEv .

■ F1-11: Speed Deviation Detect DelayTime

No. (Hex.)	Name	Description	Default (Range)
F1-11 (038A)	Speed Deviation Detect DelayTime	<div style="display: flex; justify-content: space-between; font-size: 0.8em;"> V/f CL-V/f OLV CLV AOLV OLV/PM AOLV/PM CLV/PM EZOLV </div> <p>Sets the length of time that the difference between the frequency reference and speed feedback must be more than the level in $F1-10$ to cause dEv [Speed Deviation].</p>	0.5 s (0.0 - 10.0 s)

When the speed deviation between the frequency reference and the actual motor speed is more than the value set in $F1-10$ [Speed Deviation Detection Level] for longer than the time set in $F1-11$, the drive will detect dEv .

■ F1-12: Encoder 1 Gear Teeth 1

No. (Hex.)	Name	Description	Default (Range)
F1-12 (038B)	Encoder 1 Gear Teeth 1	<div style="display: flex; justify-content: space-between; font-size: 0.8em;"> V/f CL-V/f OLV CLV AOLV OLV/PM AOLV/PM CLV/PM EZOLV </div> <p>Sets the number of gear teeth on the motor side. This parameter and $F1-13$ [Encoder 1 Gear Teeth 2] set the gear ratio between the motor and encoder.</p>	0 (0 - 1000)

After you set the number of gear teeth, the drive uses this formula to calculate the motor speed:

$$\text{Motor speed (min}^{-1} \text{ or r/min)} = \frac{\text{Number of pulses from the encoder} \times 60}{F1-01} \times \frac{F1-13}{F1-12}$$

Note:

When $F1-12 = 0$ or $F1-13 = 0$, the gear ratio is 1.

■ **F1-13: Encoder 1 Gear Teeth 2**

No. (Hex.)	Name	Description	Default (Range)
F1-13 (038C)	Encoder 2 Gear Teeth 1	<div style="display: flex; justify-content: space-between; font-size: small;"> V/f CL-V/f OLV CLV AOLV OLV/PM AOLV/PM CLV/PM EZOLV </div> <p>Sets the number of gear teeth on the load side. This parameter and $F1-12$ [Encoder 1 Gear Teeth 1] set the gear ratio between the motor and encoder.</p>	0 (0 - 1000)

After you set the number of gear teeth, the drive uses this formula to calculate the motor speed:

$$\text{Motor speed (min}^{-1} \text{ or r/min)} = \frac{\text{Number of pulses from the encoder} \times 60}{F1-01} \times \frac{F1-13}{F1-12}$$

Note:

When $F1-12 = 0$ or $F1-13 = 0$, the gear ratio is 1.

■ **F1-14: Encoder Open-Circuit Detect Time**

No. (Hex.)	Name	Description	Default (Range)
F1-14 (038D)	Encoder Open-Circuit Detect Time	<div style="display: flex; justify-content: space-between; font-size: small;"> V/f CL-V/f OLV CLV AOLV OLV/PM AOLV/PM CLV/PM EZOLV </div> <p>Sets the length of time that the drive must not receive a pulse signal to cause PGo [Encoder (PG) Feedback Loss].</p>	2.0 s (0.0 - 10.0 s)

If the drive does not detect output pulses from the encoder for longer than the time set in $F1-14$, the drive will detect PGo .

Note:

Motor speed and load conditions can cause ov [Overvoltage] and oC [Overcurrent] faults.

■ **F1-17: Deviation 2 Detection Selection**

No. (Hex.)	Name	Description	Default (Range)
F1-17 (03AC)	Deviation 2 Detection Selection	<div style="display: flex; justify-content: space-between; font-size: small;"> V/f CL-V/f OLV CLV AOLV OLV/PM AOLV/PM CLV/PM EZOLV </div> <p>Usually it is not necessary to change this setting. Sets the number of motor rotations that the drive will detect more than one Z pulse per rotation to detect $dv2$.</p>	10 (0 - 100)

When $F1-17 = 0$, the drive will not detect $dv2$.

■ **F1-18: Deviation 3 Detection Selection**

No. (Hex.)	Name	Description	Default (Range)
F1-18 (03AD)	Deviation 3 Detection Selection	<div style="display: flex; justify-content: space-between; font-size: small;"> V/f CL-V/f OLV CLV AOLV OLV/PM AOLV/PM CLV/PM EZOLV </div> <p>Sets the number of rotations necessary to detect conditions that invert the torque reference and rate of acceleration and cause $dv3$ [Inversion Detection].</p>	10 (0 - 10)

When the drive detects these two conditions at the same time for the number of times set in $F1-18$, the drive will detect $dv3$.

- The torque reference and acceleration are in opposite directions. For example, torque reference is in forward run and the acceleration is in a negative direction.
- The difference between the speed reference and the actual motor speed is more than 30%.

Note:

- Reference the setting value for $E5-11$ [Encoder Z-Pulse Offset] and the $\delta\theta$ value found on the motor nameplate. A usual cause for a $dv3$ fault is an incorrect $E5-11$ setting.
- Set $F1-18 = 0$ to disable the function.

■ F1-19: Deviation 4 Detection Selection

No. (Hex.)	Name	Description	Default (Range)
F1-19 (03AE)	Deviation 4 Detection Selection	<div style="display: flex; justify-content: space-between; font-size: small;"> V/f CL-V/f OLV CLV AOLV OLV/PM AOLV/PM CLV/PM EZOLV </div> Sets the number of pulses necessary to cause <i>dv4</i> [Inversion Prevention Detection].	128 (0 - 5000)

The drive detects a *dv4* [Inversion Prevention Detection] fault when the pulses in a reverse direction to the speed reference are input for longer than the time set in *F1-19*.

Note:

- Refer to the *E5-11* [Encoder Z-Pulse Offset] value and the $\Delta\theta$ value shown on the motor nameplate. An incorrect *E5-11* value will frequently be the cause of a *dv4* fault.
- When you use the drive in an application that rotates the motor from the load side in the reverse direction of the speed reference, set *F1-19* = 0.

■ F1-20: Encoder 1 PCB Disconnect Detect

No. (Hex.)	Name	Description	Default (Range)
F1-20 (03B4)	Encoder 1 PCB Disconnect Detect	<div style="display: flex; justify-content: space-between; font-size: small;"> V/f CL-V/f OLV CLV AOLV OLV/PM AOLV/PM CLV/PM EZOLV </div> Sets the function that enables and disables detection of a disconnected encoder connection cable to cause <i>PGoH</i> [Encoder (PG) Hardware Fault].	1 (0, 1)

0 : Disabled

1 : Enabled

■ F1-21: Encoder 1 Signal Selection

No. (Hex.)	Name	Description	Default (Range)
F1-21 (03BC)	Encoder 1 Signal Selection	<div style="display: flex; justify-content: space-between; font-size: small;"> V/f CL-V/f OLV CLV AOLV OLV/PM AOLV/PM CLV/PM EZOLV </div> Sets the number of channels for the signal to the encoder option card.	0 (0, 1)

0 : A Pulse Detection

1 : AB Pulse Detection

■ F1-30: Motor 2 Encoder PCB Port Select

No. (Hex.)	Name	Description	Default (Range)
F1-30 (03AA)	Motor 2 Encoder PCB Port Select	<div style="display: flex; justify-content: space-between; font-size: small;"> V/f CL-V/f OLV CLV AOLV OLV/PM AOLV/PM CLV/PM EZOLV </div> Sets the drive port to install the motor 2 encoder option card.	1 (0, 1)

0 : CN5-C

One option card receives the speed feedback signals from motor 1 and motor 2.

1 : CN5-B

Two option cards receive the speed feedback signals from motor 1 and motor 2.

■ F1-31: Encoder 2 Pulse Count (PPR)

No. (Hex.)	Name	Description	Default (Range)
F1-31 (03B0)	Encoder 2 Pulse Count (PPR)	<div style="display: flex; justify-content: space-between; font-size: small;"> V/f CL-V/f OLV CLV AOLV OLV/PM AOLV/PM CLV/PM EZOLV </div> Sets the number of output pulses for each motor revolution for motor 2.	1024 ppr (1 - 60000 ppr)

■ F1-32: Encoder 2 Rotation Selection

No. (Hex.)	Name	Description	Default (Range)
F1-32 (03B1)	Encoder 2 Rotation Selection	<div style="display: flex; justify-content: space-between; font-size: small;"> V/f CL-V/f OLV CLV AOLV OLV/PM AOLV/PM CLV/PM EZOLV </div> Sets the output sequence for the A and B pulses from the encoder for motor 2. This parameter assumes that the motor is operating in the forward direction.	0 (0, 1)

Refer to the option card installation manual for more information about how to set the encoder pulse output sequence and make sure that it is correct.

0 : Pulse A leads in FWD Direction

1 : Pulse B leads in FWD Direction

■ **F1-33: Encoder 2 Gear Teeth 1**

No. (Hex.)	Name	Description	Default (Range)
F1-33 (03B2)	Encoder 2 Gear Teeth 1	<div style="display: flex; justify-content: space-between; font-size: small;"> V/f CL-V/f OLV CLV AOLV OLV/PM AOLV/PM CLV/PM EZOLV </div> <p>Sets the number of gear teeth on the motor side for motor 2. This parameter and F1-34 [Encoder 2 Gear Teeth 2] set the gear ratio between the motor and encoder.</p>	0 (0 - 1000)

After you set the number of gear teeth, the drive uses this formula to calculate the motor speed:

$$\text{Motor speed (min}^{-1} \text{ or r/min)} = \frac{\text{Number of pulses from the encoder} \times 60}{F1-31} \times \frac{F1-33}{F1-34}$$

Note:

When F1-33 = 0 or F1-34 = 0, the gear ratio is 1.

■ **F1-34: Encoder 2 Gear Teeth 2**

No. (Hex.)	Name	Description	Default (Range)
F1-34 (03B3)	Encoder 2 Gear Teeth 2	<div style="display: flex; justify-content: space-between; font-size: small;"> V/f CL-V/f OLV CLV AOLV OLV/PM AOLV/PM CLV/PM EZOLV </div> <p>Sets the number of gear teeth on the load side for motor 2. This parameter and F1-33 [Encoder 2 Gear Teeth 1] set the gear ratio between the motor and encoder.</p>	0 (0 - 1000)

After you set the number of gear teeth, the drive uses this formula to calculate the motor speed:

$$\text{Motor speed (min}^{-1} \text{ or r/min)} = \frac{\text{Number of pulses from the encoder} \times 60}{F1-31} \times \frac{F1-33 \text{ (load-side PG gear teeth)}}{F1-34 \text{ (motor-side PG gear teeth)}}$$

Note:

When F1-33 = 0 or F1-34 = 0, the gear ratio is 1.

■ **F1-35: Encoder 2 Pulse Monitor Scaling**

No. (Hex.)	Name	Description	Default (Range)
F1-35 (03BE)	Encoder 2 Pulse Monitor Scaling	<div style="display: flex; justify-content: space-between; font-size: small;"> V/f CL-V/f OLV CLV AOLV OLV/PM AOLV/PM CLV/PM EZOLV </div> <p>Sets the ratio between the pulse input and the pulse output of the encoder as a 3-digit number for motor 2. The first digit is the numerator and the second and third digits set the denominator.</p>	001 (001 - 032, 102 - 132 (1 - 1/32))

When the setting value is a 3-digit value (xyz), the dividing ratio is (1 + x)/yz.

For example, when F1-35 = 032, the dividing ratio is 1/32.

Note:

For a single-pulse encoder, the dividing ratio for the monitor signal is 1:1.

■ **F1-36: Encoder 2 PCB Disconnect Detect**

No. (Hex.)	Name	Description	Default (Range)
F1-36 (03B5)	Encoder 2 PCB Disconnect Detect	<div style="display: flex; justify-content: space-between; font-size: small;"> V/f CL-V/f OLV CLV AOLV OLV/PM AOLV/PM CLV/PM EZOLV </div> <p>Sets the function that enables and disables detection of a disconnected encoder connection cable to cause PGoH [Encoder (PG) Hardware Fault] for motor 2.</p>	1 (0, 1)

0 : Disabled

1 : Enabled

■ F1-37: Encoder 2 Signal Selection

No. (Hex.)	Name	Description	Default (Range)
F1-37 (03BD)	Encoder 2 Signal Selection	V/f CL-V/f OLV CLV AOLV OLV/PM AOLV/PM CLV/PM EZOLV Sets the number of channels for the signal to the encoder option card for motor 2.	0 (0, 1)

0 : A Pulse Detection

1 : AB Pulse Detection

■ F1-46: Deviation 2 Detection Method Selection

No. (Hex.)	Name	Description	Default (Range)
F1-46 (1B98)	Deviation 2 Detection Method Selection	V/f CL-V/f OLV CLV AOLV OLV/PM AOLV/PM CLV/PM EZOLV Usually it is not necessary to change this setting. Sets the detection method for <i>dv2</i> [<i>Z Pulse Noise Fault Detection</i>].	0 (0, 1)

To detect *dv2* while a multi-pole motor (for example 24 or more poles) is running at zero speed, set *F1-46* = 1 [*Mechanical Angle Detection Method*].

0 : Electrical Angle Detection Method

1 : Mechanical Angle Detection Method

■ F1-47: Deviation 2 Detection Selection

No. (Hex.)	Name	Description	Default (Range)
F1-47 (1B99)	Deviation 2 Detection Selection	V/f CL-V/f OLV CLV AOLV OLV/PM AOLV/PM CLV/PM EZOLV Usually it is not necessary to change this setting. Sets the sensitivity of detection for <i>dv2</i> [<i>Z Pulse Noise Fault Detection</i>]. Increase the value to decrease the sensitivity.	15° (0 - 180°)

These *F1-46* [*dv2 Detection Method Selection*] settings change the setting units of *F1-47*:

- *F1-46* = 0: *F1-47* uses electric angles (deg)
- *F1-46* = 1: *F1-47* uses mechanical angles (one motor rotation is equivalent to a mechanical angle of 360 degrees)

■ F1-50: PG-F3 Option Encoder Type

No. (Hex.)	Name	Description	Default (Range)
F1-50 (03D2)	PG-F3 Option Encoder Type	V/f CL-V/f OLV CLV AOLV OLV/PM AOLV/PM CLV/PM EZOLV Sets the type of encoder connected to the PG-F3 option.	0 (0 - 2)

0 : EnDat Sin/Cos

1 : EnDat Serial Only

2 : HIPERFACE

■ F1-51: PG-F3 PGoH Detection Level

No. (Hex.)	Name	Description	Default (Range)
F1-51 (03D3)	PG-F3 PGoH Detection Level	V/f CL-V/f OLV CLV AOLV OLV/PM AOLV/PM CLV/PM EZOLV The drive will detect <i>PGoH</i> [<i>Encoder (PG) Hardware Fault</i>] if the value of this parameter is smaller than the value of $\sqrt{\sin^2\theta + \cos^2\theta}$.	80% (1 - 100%)

The drive will detect *PGoH* if the value of this parameter is smaller than the value of $\sqrt{\sin^2\theta + \cos^2\theta}$.

Regarding the expression $\sqrt{\sin^2\theta + \cos^2\theta}$, Sin θ is the single-track (phase B) output from the encoder and Cos θ is the single-track (phase A) output from the encoder.

Note:

This function is enabled when *F1-20* = 1 [*Encoder 1 PCB Disconnect Detect = Enabled*].

■ F1-52: Serial Encoder Comm Speed

No. (Hex.)	Name	Description	Default (Range)
F1-52 (03D4)	Serial Encoder Comm Speed	<div style="display: flex; justify-content: space-between; font-size: 0.8em; font-weight: normal;"> V/f CL-V/f OLV CLV AOLV OLV/PM AOLV/PM CLV/PM EZOLV </div> Sets the communication speed between the PG-F3 option and the serial encoder.	0 (0 - 2)

Note:

This function is enabled when $F1-50 = 1$ or 2 [$PG-F3$ Option Encoder Type = EnDat Serial Only or HIPERFACE].

0 : 1M/9600bps

1 : 500k/19200bps

2 : 1M/38400bps

◆ F2: Analog Input Option

F2 parameters set the operation of the drive when you use analog input option card AI-A3. The AI-A3 card has 3 input terminals that accept voltages of -10 V to +10 V (20 kΩ) or currents of 4 mA to 20 mA (250 Ω). Install the AI-A3 card to enable setting very accurate analog references with high resolution.

Refer to the AI-A3 option manual for more information about how to install, wire, and set the AI-A3 card.

WARNING! Sudden Movement Hazard. Do test runs and examine the drive to make sure that the command references are correct. If you set the command reference incorrectly, it can cause damage to the drive or serious injury or death.

■ F2-01: Analog Input Function Selection

No. (Hex.)	Name	Description	Default (Range)
F2-01 (038F)	Analog Input Function Selection	<div style="display: flex; justify-content: space-between; font-size: 0.8em; font-weight: normal;"> V/f CL-V/f OLV CLV AOLV OLV/PM AOLV/PM CLV/PM EZOLV </div> Sets the input method for the analog reference used with AI-A3.	0 (0, 1)

Note:

When the AI-A3 card is not mounted in the drive, analog input terminals A1 to A3 on the drive are always enabled. The setting of this parameter does not have an effect.

0 : 3 Independent Channels

Set $F2-01 = 0$ to increase the precision of A/D conversion when you use the functions for terminals A1 to A3 on the drive as they are. You can input the MFAI signal from terminals V1 through V3 for AI-A3. The functions for terminals A1, A2, and A3 on the drive are sent to terminals V1, V2, and V3 for AI-A3. Use gain and bias adjustment when you input current to set signals to have negative numbers.

Note:

- Set $b1-01 = 1$ [*Frequency Reference Selection 1 = Analog Input*] to set inputs individually.
- If $F2-01 = 0$ and $b1-01 = 3$ [*Option PCB*], the drive will detect $oPE05$ [*Run Cmd/Freq Ref Source Sel Err*].

Figure 12.74 shows the individual input of analog inputs. *H3-xx parameters* set the function to input the analog reference received from the AI-A3 card and to adjust the gain and bias of these signals.

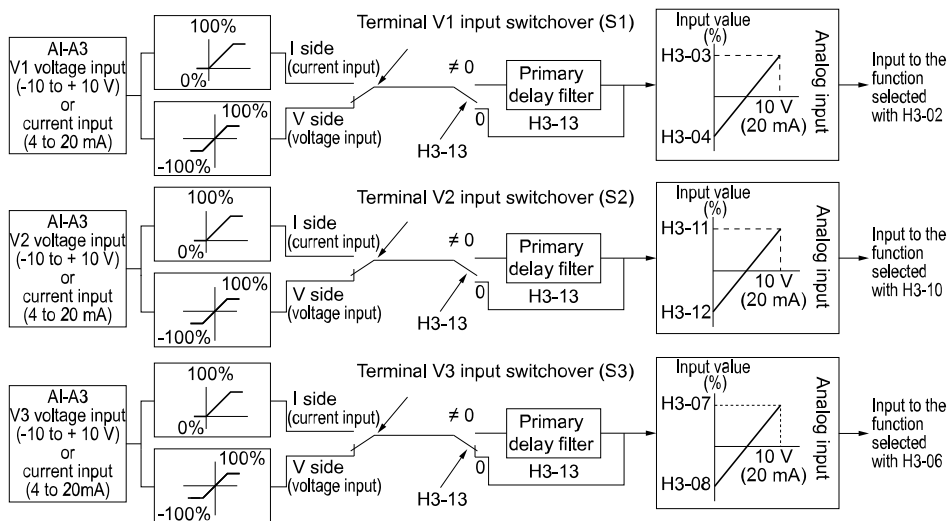

Figure 12.74 Analog Input Reference Individual Input Block Diagram

1 : 3 Channels Added Together

Set $b1-01 = 3$ [Option PCB] to set addition input.

You can input the frequency reference directly. The sum value when you add the input from terminals V1 to V3 becomes the frequency reference.

Set $F2-01 = 1$ to use the AI-A3 card as addition input.

Figure 12.75 shows addition input. Use $F2-02$ [Analog Input Option Card Gain] and $F2-03$ [Analog Input Option Card Bias] to adjust the analog reference gain and bias for addition input.

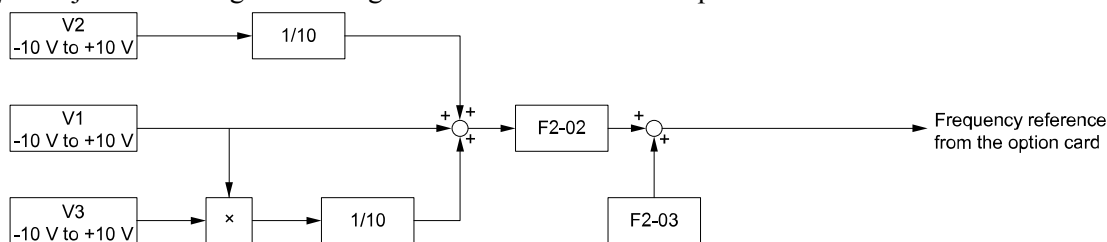

Figure 12.75 Analog Input Reference Addition Input Block Diagram

Use F2-02 and F2-03 to Adjust the Input Status

When the bias set in $F2-03$ is 0%, the gain in $F2-02$ and the addition input value set the ratio (%) of the maximum output frequency output as the frequency reference.

Note:

A voltage input of 10 V or a current input of 20 mA is the 100% value for each channel.

The bias set in $F2-03$ sets the ratio (%) of the maximum output frequency output as the frequency reference when the addition input value is 0%.

Note:

A voltage input of 0 V or a current input of 4 mA is the 0% value for each channel.

- Example 1:
When the gain set in $F2-02$ is 50%, the bias set in $F2-03$ is 0%, and the addition input value is 100%, the frequency reference is 50% of the maximum output frequency. When the addition input value is 200%, the frequency reference is 100% of the maximum output frequency.
- Example 2:
When the gain set in $F2-02$ is 200%, the bias set in $F2-03$ is 0%, and the addition input value is 50%, the frequency reference is equivalent to the maximum output frequency. The frequency reference will not be more than the maximum output frequency, although the addition input value is 50% or higher.
- Example 3:
When the gain set in $F2-02$ is 100%, the bias set in $F2-03$ is 30%, and the addition input value is 0%, the frequency reference is 30% of the maximum output frequency. When the addition input value is 70%, the frequency reference

will be equivalent to the maximum output frequency. The frequency reference will not be more than the maximum output frequency, although the addition input value is 70% or higher.

■ **F2-02: Analog Input Option Card Gain**

No. (Hex.)	Name	Description	Default (Range)
F2-02 (0368) RUN	Analog Input Option Card Gain	<div style="display: flex; justify-content: space-between; font-size: small;"> V/f CL-V/f OLV CLV AOLV OLV/PM AOLV/PM CLV/PM EZOLV </div> <p>Sets the analog reference gain as a percentage when the maximum output frequency is 100%.</p>	100.0% (-999.9 - +999.9%)

Note:

Set *F2-01* = 1 [*Analog Input Function Selection* = 3 Channels Added Together] to enable this function.

■ **F2-03: Analog Input Option Card Bias**

No. (Hex.)	Name	Description	Default (Range)
F2-03 (0369) RUN	Analog Input Option Card Bias	<div style="display: flex; justify-content: space-between; font-size: small;"> V/f CL-V/f OLV CLV AOLV OLV/PM AOLV/PM CLV/PM EZOLV </div> <p>Sets the analog reference bias as a percentage when the maximum output frequency is 100%.</p>	0.0% (-999.9 - +999.9%)

Note:

Set *F2-01* = 1 [*Analog Input Function Selection* = 3 Channels Added Together] to enable this function.

◆ **F3: Digital Input Option**

F3 parameters set the type of input signal to use with digital input option card DI-A3.

Use these digital inputs to set the frequency reference when you install the DI-A3 card in a drive. Set *b1-01* = 3 [*Frequency Reference Selection 1* = Option PCB] to use this card as the frequency reference input. The input signal is isolated input of 24 Vdc and 8 mA.

- Binary, 16-bit/BCD, 4-digit input
- Binary, 12-bit/BCD, 3-digit input
- Binary, 8-bit/BCD, 2-digit input

You can also use the DI-A3 card as an MFDI, if the setting of *F3-01* is correct.

WARNING! Sudden Movement Hazard. Do test runs and examine the drive to make sure that the command references are correct. If you set the command reference incorrectly, it can cause damage to the drive or serious injury or death.

■ **MFDI for DI-A3**

Set *F3-01* = 8 [*Digital Input Function Selection* = Multi-Function Digital Input] and *b1-01* ≠ 3 [*Frequency Reference Selection 1* ≠ Option PCB] to use digital input option DI-A3 as an MFDI.

Use *F3-10* to *F3-25* [*Terminal D0 Function Selection* to *Terminal DF Function Selection*] to set the function for the DI-A3 terminals.

Note:

- Refer to H1-xx “Multi-function Digital Input Setting Values” for more information about MFDI setting values.
- Values 0 [*3-Wire Sequence*] and 20 to 2F [*External Fault*] for *F3-10* to *F3-25*.
- When you do not use DI-A3 as an MFDI, set *F3-10* to *F3-25* = F [*Not Used*].
- The drive reads DI-A3 terminal Dx two times as specified by parameter *b1-06* [*Digital Input Reading*].
- Configuring such that *F3-01* = 8 when DI-A3 is the frequency reference source (*b1-01* or *b1-15* = 3 [*Frequency Reference Selection 1/2* = Option PCB]) results in the detection of oPE05 [*Run Cmd/Freq Ref Source Sel Err*].
- You can use these functions with the DI-A3 MFDI:
 - H1-40 to H1-42 [*Mbus Reg 15C0h bit0 to bit2 Input Func*]
 - H7-01 to H7-04 [*Virtual Multi-Function Input 1 to 4*]

■ F3-01: Digital Input Function Selection

No. (Hex.)	Name	Description	Default (Range)
F3-01 (0390)	Digital Input Function Selection	<div style="display: flex; justify-content: space-between; align-items: center;"> V/f CL-V/f OLV CLV AOLV OLV/PM AOLV/PM CLV/PM EZOLV </div> <p>Sets the data format of digital input signals. This parameter is enabled when <i>o1-03</i> = 0 or 1 [Frequency Display Unit Selection = 0.01 Hz or 0.01% (100% = E1-04)].</p>	8 (0 - 8)

Note:

The input signal type is BCD when *o1-03* = 2 or 3 [Revolutions Per Minute (RPM) or User Units (*o1-10* & *o1-11*)]. The *o1-03* value sets the setting units.

0 : BCD, 1% units

1 : BCD, 0.1% units

2 : BCD, 0.01% units

3 : BCD, 1 Hz units

4 : BCD, 0.1 Hz units

5 : BCD, 0.01 Hz units

6 : BCD (5-digit), 0.01 Hz

7 : Binary input

The setting unit and setting range vary depending on the value set in *F3-03* [Digital Input Data Length Select].

- *F3-03* = 0 [8-bit]: 100%/255 (-255 to +255)
- *F3-03* = 1 [12-bit]: 100%/4095 (-4095 to +4095)
- *F3-03* = 2 [16-bit]: 100%/30000 (-33000 to +33000)

8 : Multi-Function Digital Input

The DI-A3 card is also used as a multi-function digital input terminal.

■ F3-03: Digital Input Data Length Select

No. (Hex.)	Name	Description	Default (Range)
F3-03 (03B9)	Digital Input Data Length Select	<div style="display: flex; justify-content: space-between; align-items: center;"> V/f CL-V/f OLV CLV AOLV OLV/PM AOLV/PM CLV/PM EZOLV </div> <p>Sets the number of bits to set the frequency reference with <i>DI-A3</i>.</p>	2 (0 - 2)

0 : 8-bit

1 : 12-bit

2 : 16-bit

Table 12.44 DI-A3 Terminal Function Selection

Terminal Block	Terminal Name	BCD, Signed [F3-01 = 0 to 5]						BCD, Unsigned [F3-01 = 6] ^{*1}		Binary, Signed [F3-01 = 7]			
		8-bit [F3-03 = 0]		12-bit [F3-03 = 1]		16-bit [F3-03 = 2]		8-bit [F3-03 = 0]	12-bit [F3-03 = 1]	16-bit [F3-03 = 2]			
TB2	D0	1 digit (0 - 9)	1	1 digit (0 - 9)	1	1 digit (0 - 9)	1	1 digit (0, 2, 4, 6, 8)	2	bit 0	bit 0	bit 0	
	D1		2		2		2		4	bit 1	bit 1	bit 1	
	D2		4		4		4		8	bit 2	bit 2	bit 2	
	D3		8		8		8		2 digits (0 - 9)	1	bit 3	bit 3	bit 3
	D4	2 digits (0 - 15) ^{*2}	1	2 digits (0 - 9)	1	2 digits (0 - 9)	1	2		bit 4	bit 4	bit 4	
	D5		2		2		2	4		bit 5	bit 5	bit 5	
	D6		4		4		4	8		bit 6	bit 6	bit 6	
	D7		8		8		8	3 digits (0 - 9)	1	bit 7	bit 7	bit 7	
TB3	D8	-	-	3 digits (0 - 15) ^{*2}	1	3 digits (0 - 9)	-		4 digits (0 - 9)	2	-	bit 8	bit 8
	D9	-	-		2		-			4	-	bit 9	bit 9
	DA	-	-		4		-			8	-	bit 10	bit 10
	DB	-	-		8		-	5 digits (0 - 3)		1	-	bit 11	bit 11
	DC	-	-	-	4 digits (0 - 15) ^{*2}	-	2		-	-	bit 12		
	DD	-	-	-		-	4		-	-	bit 13		
	DE	-	-	-		-	8		-	-	bit 14		
	DF	-	-	-		-	-	1	-	-	bit 15		
TB1	SI	SIGN (encoded) signal 0: Forward run, 1: Reverse run								SIGN (encoded) signal 0: Forward run, 1: Reverse run			
	SE	SET (loaded) signal 1: Loads the value set for D0 to DF and SI.											
	SP	Internal power supply: 24 V ± 5%											
	SC	Input signal common											
	SN	Internal power supply common: 0 V											
	SD	Cable sheath connection terminal (ungrounded)											
	FE	Cable sheath connection terminal (grounded)											

*1 Setting F3-03 = 2 [Digital Input Data Length Select = 16-bit] enables F3-01 = 6 [Digital Input Function Selection = BCD (5-digit), 0.01 Hz] and a frequency between 0.00 Hz to 399.8 Hz can be set by the BCD. Note that terminal SI is also used as for data bits. Negative commands cannot be input as encoding information (positive/negative) cannot be added to the data.

The minimum bit value for the first BCD digit is 2. For this reason, 0.02 Hz is the smallest setting unit available for this frequency setting. An oPE05 [Run Cmd/Freq Ref Source Sel Err] occurs when F3-03 ≠ 2 while F3-01 = 6.

*2 The most significant digit can be set to a value between 0 to 15 when using "BCD, Signed". Other digits can be set to a value between 0 to 9.

F3-10: Terminal D0 Function Selection

No. (Hex.)	Name	Description	Default (Range)
F3-10 (0BE3) Expert	Terminal D0 Function Selection	V/f CL-V/f OLV CLV AOLV OLV/PM AOLV/PM CLV/PM EZOLV Sets the function for terminal D0 of the DI-A3 option when F3-01 = 8 [Digital Input Function Selection = Multi-Function Digital Input].	F (1 - 19F)

F3-11: Terminal D1 Function Selection

No. (Hex.)	Name	Description	Default (Range)
F3-11 (0BE4) Expert	Terminal D1 Function Selection	V/f CL-V/f OLV CLV AOLV OLV/PM AOLV/PM CLV/PM EZOLV Sets the function for terminal D1 of the DI-A3 option when F3-01 = 8 [Digital Input Function Selection = Multi-Function Digital Input].	F (1 - 19F)

■ F3-12: Terminal D2 Function Selection

No. (Hex.)	Name	Description	Default (Range)
F3-12 (0BE5) Expert	Terminal D2 Function Selection	V/f CL-V/f OLV CLV AOLV OLV/PM AOLV/PM CLV/PM EZOLV Sets the function for terminal D2 of the DI-A3 option when $F3-01 = 8$ [Digital Input Function Selection = Multi-Function Digital Input].	F (1 - 19F)

■ F3-13: Terminal D3 Function Selection

No. (Hex.)	Name	Description	Default (Range)
F3-13 (0BE6) Expert	Terminal D3 Function Selection	V/f CL-V/f OLV CLV AOLV OLV/PM AOLV/PM CLV/PM EZOLV Sets the function for terminal D3 of the DI-A3 option when $F3-01 = 8$ [Digital Input Function Selection = Multi-Function Digital Input].	F (1 - 19F)

■ F3-14: Terminal D4 Function Selection

No. (Hex.)	Name	Description	Default (Range)
F3-14 (0BE7) Expert	Terminal D4 Function Selection	V/f CL-V/f OLV CLV AOLV OLV/PM AOLV/PM CLV/PM EZOLV Sets the function for terminal D4 of the DI-A3 option when $F3-01 = 8$ [Digital Input Function Selection = Multi-Function Digital Input].	F (1 - 19F)

■ F3-15: Terminal D5 Function Selection

No. (Hex.)	Name	Description	Default (Range)
F3-15 (0BE8) Expert	Terminal D5 Function Selection	V/f CL-V/f OLV CLV AOLV OLV/PM AOLV/PM CLV/PM EZOLV Sets the function for terminal D5 of the DI-A3 option when $F3-01 = 8$ [Digital Input Function Selection = Multi-Function Digital Input].	F (1 - 19F)

■ F3-16: Terminal D6 Function Selection

No. (Hex.)	Name	Description	Default (Range)
F3-16 (0BE9) Expert	Terminal D6 Function Selection	V/f CL-V/f OLV CLV AOLV OLV/PM AOLV/PM CLV/PM EZOLV Sets the function for terminal D6 of the DI-A3 option when $F3-01 = 8$ [Digital Input Function Selection = Multi-Function Digital Input].	F (1 - 19F)

■ F3-17: Terminal D7 Function Selection

No. (Hex.)	Name	Description	Default (Range)
F3-17 (0BEA) Expert	Terminal D7 Function Selection	V/f CL-V/f OLV CLV AOLV OLV/PM AOLV/PM CLV/PM EZOLV Sets the function for terminal D7 of the DI-A3 option when $F3-01 = 8$ [Digital Input Function Selection = Multi-Function Digital Input].	F (1 - 19F)

■ F3-18: Terminal D8 Function Selection

No. (Hex.)	Name	Description	Default (Range)
F3-18 (0BEB) Expert	Terminal D8 Function Selection	V/f CL-V/f OLV CLV AOLV OLV/PM AOLV/PM CLV/PM EZOLV Sets the function for terminal D8 of the DI-A3 option when $F3-01 = 8$ [Digital Input Function Selection = Multi-Function Digital Input].	F (1 - 19F)

■ F3-19: Terminal D9 Function Selection

No. (Hex.)	Name	Description	Default (Range)
F3-19 (0BEC) Expert	Terminal D9 Function Selection	<div style="display: flex; justify-content: space-between; gap: 5px;"> V/f CL-V/f OLV CLV AOLV OLV/PM AOLV/PM CLV/PM EZOLV </div> Sets the function for terminal D9 of the DI-A3 option when $F3-01 = 8$ [Digital Input Function Selection = Multi-Function Digital Input].	F (1 - 19F)

■ F3-20: Terminal DA Function Selection

No. (Hex.)	Name	Description	Default (Range)
F3-20 (0BED) Expert	Terminal DA Function Selection	<div style="display: flex; justify-content: space-between; gap: 5px;"> V/f CL-V/f OLV CLV AOLV OLV/PM AOLV/PM CLV/PM EZOLV </div> Sets the function for terminal DA of the DI-A3 option when $F3-01 = 8$ [Digital Input Function Selection = Multi-Function Digital Input].	F (1 - 19F)

■ F3-21: Terminal DB Function Selection

No. (Hex.)	Name	Description	Default (Range)
F3-21 (0BEE) Expert	Terminal DB Function Selection	<div style="display: flex; justify-content: space-between; gap: 5px;"> V/f CL-V/f OLV CLV AOLV OLV/PM AOLV/PM CLV/PM EZOLV </div> Sets the function for terminal DB of the DI-A3 option when $F3-01 = 8$ [Digital Input Function Selection = Multi-Function Digital Input].	F (1 - 19F)

■ F3-22: Terminal DC Function Selection

No. (Hex.)	Name	Description	Default (Range)
F3-22 (0BEF) Expert	Terminal DC Function Selection	<div style="display: flex; justify-content: space-between; gap: 5px;"> V/f CL-V/f OLV CLV AOLV OLV/PM AOLV/PM CLV/PM EZOLV </div> Sets the function for terminal DC of the DI-A3 option when $F3-01 = 8$ [Digital Input Function Selection = Multi-Function Digital Input].	F (1 - 19F)

■ F3-23: Terminal DD Function Selection

No. (Hex.)	Name	Description	Default (Range)
F3-23 (0BF0) Expert	Terminal DD Function Selection	<div style="display: flex; justify-content: space-between; gap: 5px;"> V/f CL-V/f OLV CLV AOLV OLV/PM AOLV/PM CLV/PM EZOLV </div> Sets the function for terminal DD of the DI-A3 option when $F3-01 = 8$ [Digital Input Function Selection = Multi-Function Digital Input].	F (1 - 19F)

■ F3-24: Terminal DE Function Selection

No. (Hex.)	Name	Description	Default (Range)
F3-24 (0BF1) Expert	Terminal DE Function Selection	<div style="display: flex; justify-content: space-between; gap: 5px;"> V/f CL-V/f OLV CLV AOLV OLV/PM AOLV/PM CLV/PM EZOLV </div> Sets the function for terminal DE of the DI-A3 option when $F3-01 = 8$ [Digital Input Function Selection = Multi-Function Digital Input].	F (1 - 19F)

■ F3-25: Terminal DF Function Selection

No. (Hex.)	Name	Description	Default (Range)
F3-25 (0BF2) Expert	Terminal DF Function Selection	<div style="display: flex; justify-content: space-between; gap: 5px;"> V/f CL-V/f OLV CLV AOLV OLV/PM AOLV/PM CLV/PM EZOLV </div> Sets the function for terminal DF of the DI-A3 option when $F3-01 = 8$ [Digital Input Function Selection = Multi-Function Digital Input].	F (1 - 19F)

◆ F4: Analog Monitor Option

$F4$ parameters set drive operation when you use analog monitor option card AO-A3. The AO-A3 card has 2 output terminals (terminals V1 and V2) for signals with an Output resolution of 11 bits (1/2048) + encoding and that have an

output voltage range of -10 V to +10 V. Install the AO-A3 card to a drive to output analog signals that monitor the output status of the drive (output frequency and output current).

Refer to the AO-A3 card manual for more information about how to install, wire, and set the AO-A3 card.

Use the *U monitor* number to set the monitor data to be output from terminals V1 and V2 on the AO-A3 card. Enter the last three digits of *Ux-xx* as the setting value.

- Use Gain and Bias to Adjust the Output Signal Level of Terminal V1

You must stop the drive to adjust the output signal. Use this procedure to calibrate the drive:

1. View the *F4-02 [Terminal V1 Gain]* value on the keypad.
Terminal V1 will output a voltage = 100% of the monitor set in *F4-01 [Terminal V1 Function Selection]*.
2. View the monitor connected to terminal V1 and adjust *F4-02*.
3. View the *F4-05 [Terminal V1 Bias]* value on the keypad.
Terminal V1 will output an analog signal = 100% of the parameter set in *F4-01*.
4. View the monitor connected to terminal V1 and adjust *F4-05*.

- Use Gain and Bias to Adjust the Output Signal Level of Terminal V2

You must stop the drive to adjust the output signal. Use this procedure to calibrate the drive:

1. View the *F4-04 [Terminal V2 Gain]* value on the keypad.
Terminal V2 will output a voltage = 100% of the monitor set in *F4-03 [Terminal V2 Function Selection]*.
2. View the monitor connected to terminal V2 and adjust *F4-04*.
3. View the *F4-06 [Terminal V2 Bias]* value on the keypad.
The analog signal equal to 0% of the parameter being set in *F4-03* will be output from terminal V2.
4. View the monitor connected to terminal V2 and adjust *F4-06*.

■ F4-01: Terminal V1 Function Selection

No. (Hex.)	Name	Description	Default (Range)
F4-01 (0391)	Terminal V1 Function Selection	 Sets the monitor signal output from terminal V1.	102 (000 - 999)

Set the *x-xx* part of the *Ux-xx [Monitors]* to set monitor data to output from the option card. For example, set *F4-01 = 102* to monitor *U1-02 [Output Frequency]*.

Note:

- You cannot use all of the monitors in all of the control methods.
- When you use the terminal in through mode, set this parameter to *000* or *031*. You can use MEMOBUS/Modbus communications or the communication option to set the terminal V1 output level from the PLC.

■ F4-02: Terminal V1 Gain

No. (Hex.)	Name	Description	Default (Range)
F4-02 (0392) RUN	Terminal V1 Gain	 Sets the gain of the monitor signal that is sent from terminal V1. Sets the analog signal output level from the terminal V1 at 10 V or 20 mA as 100% when an output for monitoring items is 100%.	100.0% (-999.9 - +999.9%)

The maximum output voltage output from terminal V1 is ± 10 V. Use *F4-07 [Terminal V1 Signal Level]* to set the signal level.

Example settings:

When you use these settings, and the monitored output voltage is at 100% (drive rated current), the output voltage of terminal V1 is 5 V (50% of 10 V). The output current is 200% of the drive rated current when terminal V1 outputs a maximum voltage of 10 V.

- F4-01 [Terminal V1 Function Selection] = 102 (U1-02: Output Frequency)
- F4-02 = 50.0%
- F4-05 [Terminal V1 Bias] = 0.0%
- F4-07 = 0 (0 V to 10 V)

■ F4-03: Terminal V2 Function Selection

No. (Hex.)	Name	Description	Default (Range)
F4-03 (0393)	Terminal V2 Function Selection	<div style="display: flex; justify-content: space-between; font-size: 0.8em;"> V/f CL-V/f OLV CLV AOLV OLV/PM AOLV/PM CLV/PM EZOLV </div> Sets the monitor signal output from terminal V2.	103 (000 - 999)

Set the x-xx part of the *Ux-xx* [Monitors] to set monitor data to output from the option card. For example, set *F4-03* = *103* to monitor *U1-03* [Output Current].

Note:

- You cannot use all of the monitors in all of the control methods.
- When you use the terminal in through mode, set this parameter to *000* or *031*. You can use this setting to adjust the V2 terminal output from PLC through MEMOBUS/Modbus communications or a communications option.

■ F4-04: Terminal V2 Gain

No. (Hex.)	Name	Description	Default (Range)
F4-04 (0394) RUN	Terminal V2 Gain	<div style="display: flex; justify-content: space-between; font-size: 0.8em;"> V/f CL-V/f OLV CLV AOLV OLV/PM AOLV/PM CLV/PM EZOLV </div> Sets the gain of the monitor signal that is sent from terminal V2. Sets the analog signal output level from terminal V2 at 10 V or 20 mA as 100% when an output for monitoring items is 100%.	50.0% (-999.9 - +999.9%)

The maximum output voltage output from terminal V2 is ± 10 V. Use *F4-08* [Terminal V2 Signal Level] to set the signal level.

Example settings:

When you use these settings, and the monitored output voltage is at 100% (drive rated current), the output voltage of terminal V2 is 5 V (50% of 10 V). The output current is 200% of the drive rated current when terminal V2 outputs a maximum voltage of 10 V.

- F4-03 [Terminal V2 Function Selection] = 103 (U1-03: Output Current)
- F4-04 = 50.0%
- F4-06 [Terminal V2 Bias] = 0.0%
- F4-08 = 0 (0 V to 10 V)

■ F4-05: Terminal V1 Bias

No. (Hex.)	Name	Description	Default (Range)
F4-05 (0395) RUN	Terminal V1 Bias	<div style="display: flex; justify-content: space-between; font-size: 0.8em;"> V/f CL-V/f OLV CLV AOLV OLV/PM AOLV/PM CLV/PM EZOLV </div> Sets the bias of the monitor signal that is sent from terminal V1. When an output for monitoring items is 0%, this parameter sets the analog signal output level from the V1 terminal as a percentage of 10 V or 20 mA.	0.0% (-999.9 - +999.9%)

The maximum output voltage output from terminal V1 is ± 10 V. Use *F4-07* [Terminal V1 Signal Level] to set the signal level.

■ F4-06: Terminal V2 Bias

No. (Hex.)	Name	Description	Default (Range)
F4-06 (0396) RUN	Terminal V2 Bias	<div style="display: flex; justify-content: space-between; font-size: 0.8em;"> V/f CL-V/f OLV CLV AOLV OLV/PM AOLV/PM CLV/PM EZOLV </div> Sets the bias of the monitor signal that is sent from terminal V2. Set the level of the analog signal sent from the V2 terminal at 10 V or 20 mA as 100% when an output for monitoring items is 0%.	0.0% (-999.9 - +999.9%)

The maximum output voltage output from terminal V2 is ± 10 V. Use *F4-08* [Terminal V2 Signal Level] to set the signal level.

■ F4-07: Terminal V1 Signal Level

No. (Hex.)	Name	Description	Default (Range)
F4-07 (0397)	Terminal V1 Signal Level	V/f CL-V/f OLV CLV AOLV OLV/PM AOLV/PM CLV/PM EZOLV Sets the output signal level for terminal V1.	0 (0, 1)

0 : 0 to 10 V

1 : -10 to 10 V

■ F4-08: Terminal V2 Signal Level

No. (Hex.)	Name	Description	Default (Range)
F4-08 (0398)	Terminal V2 Signal Level	V/f CL-V/f OLV CLV AOLV OLV/PM AOLV/PM CLV/PM EZOLV Sets the output signal level for terminal V2.	0 (0, 1)

0 : 0 to 10 V

1 : -10 to 10 V

◆ F5: Digital Output Option

F5 parameters set the output mode and function of output signals when you use digital output option card DO-A3. When you install a DO-A3 to the drive, you can output isolated digital signals to monitor the drive operation status.

- 6 points of photocoupler output (48 V, 50 mA or less)
- 2 points of relay contact output (250 Vac, 30 Vdc: 1 A or less)

Refer to the DO-A3 option manual for more information about how to install, wire, and set the DO-A3 card.

■ Use Parameters to Select Output Modes

Use parameter F5-09 [DO-A3 Output Mode Selection] to set signal output from the DO-A3 card.

Table 12.45 Details of F5-09 and the DO-A3 Terminal Output

DO-A3 Terminal Block	DO-A3 Terminal Name	F5-09 = 0 [Predefined Individual Outputs] (Default)	F5-09 = 1 [Binary Output]	F5-09 = 2 [Programmable (F5-01 to F5-08)]
TB1	M1-M2	Zero speed detection in progress	During run	Depending on the setting of F5-07 [Terminal M1-M2 Function Select]
	M3-M4	During speed agreement	Minor fault (excluding bb [Baseblock])	Depending on the setting of F5-08 [Terminal M3-M4 Function Select]
TB2	P1-PC	oC [Overcurrent], GF [Ground Fault]	Coded output Note: Refer to Table 12.46 for details.	Depending on the setting of F5-01 [Terminal P1-PC Function Select]
	P2-PC	ov [Overvoltage]		Depending on the setting of F5-02 [Terminal P2-PC Function Select]
	P3-PC	oL2 [Drive Overload] or oH2 [Heatsink Overheat]		Depending on the setting of F5-03 [Terminal P3-PC Function Select]
	P4-PC	Not used		Depending on the setting of F5-04 [Terminal P4-PC Function Select]
	P5-PC	oS [Overspeed]	Zero speed detection in progress	Depending on the setting of F5-05 [Terminal P5-PC Function Select]
	P6-PC	oH, oH1 [Heatsink Overheat] or oL1 [Motor Overload]	During speed agreement	Depending on the setting of F5-06 [Terminal P6-PC Function Select]

Table 12.46 Binary Output [F5-09 = 1]

Coded Output (Binary)	Description	DO-A3 Terminal Block TB2			
		Terminal P1-PC	Terminal P2-PC	Terminal P3-PC	Terminal P4-PC
0	No fault	0	0	0	0
1	oC [Overcurrent], GF [Ground Fault]	1	0	0	0
2	ov [Overvoltage]	0	1	0	0
3	oL2 [Drive Overloaded]	1	1	0	0

Coded Output (Binary)	Description	DO-A3 Terminal Block TB2			
		Terminal P1-PC	Terminal P2-PC	Terminal P3-PC	Terminal P4-PC
4	oH, oH1 [Heatsink Overheat]	0	0	1	0
5	oS [Overspeed]	1	0	1	0
6	Not used	0	1	1	0
7	rr [Dynamic Braking Transistor Fault], rH [Braking Resistor Overheat]	1	1	1	0
8	External fault [EF1 to EF8]	0	0	0	1
9	CPFxx, oFAxx, oFbxx, oFCxx [Drive Hardware Fault] ^{*1}	1	0	0	1
A	oL1 [Motor Overload]	0	1	0	1
B	Not used	1	1	0	1
C	Uv1, Uv2 [Undervoltage], Uv3 [Soft Charge Answerback Fault]	0	0	1	1
D	dEv [Speed Deviation]	1	0	1	1
E	PGo [Encoder (PG) Feedback Loss]	0	1	1	1
F	Not used	1	1	1	1

*1 The “xx” characters are different for different faults.

■ Digital Output Card Selection

Refer to “H2: Multi-function Digital Output” for more information about the functions that output from the terminals when $F5-09 = 2$ [DO-A3 Output Mode Selection = Programmable (F5-01 to F5-08)]. Use F5-01 to F5-08 to set the output items.

No.	Name	Setting Range	Default
F5-01	Terminal P1-PC Function Select	0 - 192	0: During Run
F5-02	Terminal P2-PC Function Select	0 - 192	1: Zero Speed
F5-03	Terminal P3-PC Function Select	0 - 192	2: Speed Agree 1
F5-04	Terminal P4-PC Function Select	0 - 192	4: Frequency Detection 1
F5-05	Terminal P5-PC Function Select	0 - 192	6: Drive Ready
F5-06	Terminal P6-PC Function Select	0 - 192	37: During Frequency Output
F5-07	Terminal M1-M2 Function Select	0 - 192	F: Not Used
F5-08	Terminal M3-M4 Function Select	0 - 192	F: Not Used

■ F5-01: Terminal P1-PC Function Select

No. (Hex.)	Name	Description	Default (Range)
F5-01 (0399)	Terminal P1-PC Function Select	<div style="display: flex; gap: 5px;"> V/f CL-V/f OLV CLV AOLV OLV/PM AOLV/PM CLV/PM EZOLV </div> Sets the function of terminal P1-PC on the DO-A3 option. Set $F5-09 = 2$ [DO-A3 Output Mode Selection = Programmable (F5-01 to F5-08)] to enable this function.	0 (0 - 1A7)

■ F5-02: Terminal P2-PC Function Select

No. (Hex.)	Name	Description	Default (Range)
F5-02 (039A)	Terminal P2-PC Function Select	<div style="display: flex; gap: 5px;"> V/f CL-V/f OLV CLV AOLV OLV/PM AOLV/PM CLV/PM EZOLV </div> Sets the function of terminal P2-PC on the DO-A3 option. Set $F5-09 = 2$ [DO-A3 Output Mode Selection = Programmable (F5-01 to F5-08)] to enable this function.	1 (0 - 1A7)

■ F5-03: Terminal P3-PC Function Select

No. (Hex.)	Name	Description	Default (Range)
F5-03 (039B)	Terminal P3-PC Function Select	<p>V/f CL-V/f OLV CLV AOLV OLV/PM AOLV/PM CLV/PM EZOLV</p> <p>Sets the function of terminal P3-PC on the DO-A3 option. Set $F5-09 = 2$ [DO-A3 Output Mode Selection = Programmable (F5-01 to F5-08)] to enable this function.</p>	2 (0 - 1A7)

■ F5-04: Terminal P4-PC Function Select

No. (Hex.)	Name	Description	Default (Range)
F5-04 (039C)	Terminal P4-PC Function Select	<p>V/f CL-V/f OLV CLV AOLV OLV/PM AOLV/PM CLV/PM EZOLV</p> <p>Sets the function of terminal P4-PC on the DO-A3 option. Set $F5-09 = 2$ [DO-A3 Output Mode Selection = Programmable (F5-01 to F5-08)] to enable this function.</p>	4 (0 - 1A7)

■ F5-05: Terminal P5-PC Function Select

No. (Hex.)	Name	Description	Default (Range)
F5-05 (039D)	Terminal P5-PC Function Select	<p>V/f CL-V/f OLV CLV AOLV OLV/PM AOLV/PM CLV/PM EZOLV</p> <p>Sets the function of terminal P5-PC on the DO-A3 option. Set $F5-09 = 2$ [DO-A3 Output Mode Selection = Programmable (F5-01 to F5-08)] to enable this function.</p>	6 (0 - 1A7)

■ F5-06: Terminal P6-PC Function Select

No. (Hex.)	Name	Description	Default (Range)
F5-06 (039E)	Terminal P6-PC Function Select	<p>V/f CL-V/f OLV CLV AOLV OLV/PM AOLV/PM CLV/PM EZOLV</p> <p>Sets the function of terminal P6-PC on the DO-A3 option. Set $F5-09 = 2$ [DO-A3 Output Mode Selection = Programmable (F5-01 to F5-08)] to enable this function.</p>	37 (0 - 1A7)

■ F5-07: Terminal M1-M2 Function Select

No. (Hex.)	Name	Description	Default (Range)
F5-07 (039F)	Terminal M1-M2 Function Select	<p>V/f CL-V/f OLV CLV AOLV OLV/PM AOLV/PM CLV/PM EZOLV</p> <p>Sets the function of terminal M3-M2 on the DO-A3 option. Set $F5-09 = 2$ [DO-A3 Output Mode Selection = Programmable (F5-01 to F5-08)] to enable this function.</p>	F (0 - 1A7)

■ F5-08: Terminal M3-M4 Function Select

No. (Hex.)	Name	Description	Default (Range)
F5-08 (03A0)	Terminal M3-M4 Function Select	<p>V/f CL-V/f OLV CLV AOLV OLV/PM AOLV/PM CLV/PM EZOLV</p> <p>Sets the function of terminal M3-M4 on the DO-A3 option. Set $F5-09 = 2$ [DO-A3 Output Mode Selection = Programmable (F5-01 to F5-08)] to enable this function.</p>	F (0 - 1A7)

■ F5-09: DO-A3 Output Mode Selection

No. (Hex.)	Name	Description	Default (Range)
F5-09 (03A1)	DO-A3 Output Mode Selection	<p>V/f CL-V/f OLV CLV AOLV OLV/PM AOLV/PM CLV/PM EZOLV</p> <p>Sets the output mode of signals from the DO-A3 option.</p>	0 (0 - 2)

Refer to [Table 12.45](#) for more information.

0 : Predefined Individual Outputs

1 : Binary Output

2 : Programmable (F5-01 to F5-08)

◆ F6, F7: Communication Options and Ethernet Options

F6 and F7 parameters are used to set the basic communication settings and method of fault detection for the communication option card. The communication option card parameters include common option card parameters and communication protocol-specific parameters.

The following table lists the parameters that need to be set for each communication option card.

Refer to the technical manual for each communication option card for more information on installing, wiring, and configuring the details needed before starting communication.

WARNING! Sudden Movement Hazard. Do test runs and examine the drive to make sure that the command references are correct. If you set the command reference incorrectly, it can cause damage to the drive or serious injury or death.

Table 12.47 Correspondence Between Communication Protocols and Parameters (SI-C3, SI-T3, SI-ET3, SI-P3, SI-S3, and SI-ES3)

Parameter	CC-Link SI-C3	MECHATROLINK-II SI-T3	MECHATROLINK-III SI-ET3	PROFIBUS-DP SI-P3	CANopen SI-S3	EtherCAT SI-ES3
F6-01 to F6-03	x	x	x	x	x	x
F6-04	x	-	-	-	-	-
F6-06 to F6-08	x	x	x	x	x	x
F6-10, F6-11	x	-	-	-	-	-
F6-14	x	x	x	x	x	x
F6-16	x	x	x	x	x	x
F6-20, F6-21	-	x	x	-	-	-
F6-22	-	x	-	-	-	-
F6-23 to F6-26	-	x	x	-	-	-
F6-30 to F6-32	-	-	-	x	-	-
F6-35, F6-36	-	-	-	-	x	-
F6-45 to F6-49	-	-	-	-	-	-
F6-50 to F6-71	-	-	-	-	-	-
F7-01 to F7-15	-	-	-	-	-	-
F7-16	-	-	-	-	-	-
F7-17 to F7-42	-	-	-	-	-	-
F7-60 to F7-79	-	-	-	x	-	-

Table 12.48 Correspondence Between Communication Protocols and Parameters (SI-B3, SI-N3, SI-W3, SI-EM3, SI-EP3, and SI-EN3)

Parameter	DeviceNet SI-N3	LonWorks SI-W3	Modbus TCP/IP SI-EM3	PROFINET SI-EP3	EtherNet/IP SI-EN3
F6-01 to F6-03	x	x	x	x	x
F6-04	-	-	-	-	-
F6-06 to F6-08	x	x	x	x	x
F6-10, F6-11	-	-	-	-	-
F6-14	x	x	x	x	x
F6-16	x	x	x	x	x
F6-20, F6-21	-	-	-	-	-
F6-22	-	-	-	-	-
F6-23 to F6-26	-	-	-	-	-
F6-30 to F6-32	-	-	-	-	-
F6-35, F6-36	-	-	-	-	-
F6-45 to F6-49	-	-	-	-	-

Parameter	DeviceNet SI-N3	LonWorks SI-W3	Modbus TCP/IP SI-EM3	PROFINET SI-EP3	EtherNet/IP SI-EN3
F6-50 to F6-71	x	-	-	-	-
F7-01 to F7-15	-	-	x	x	x
F7-16	-	-	x	-	-
F7-17 to F7-42	-	-	-	x	x
F7-60 to F7-79	-	-	-	-	-

■ Gateway Mode

Note:

When you use Gateway Mode, do not install the communication option in slave drives. If you install a communication option in a slave drive, the drive commands and responses will not synchronize.

In gateway mode, you can use one communication option to communicate with more than one drive.

You can use one communication option to connect a maximum of five drives to the field bus communications. Refer to [Figure 12.76](#) for more information.

When you install a communication option on the master drive, you can use the RS-485 communication card to transmit data and slave drives without a communication option can receive it.

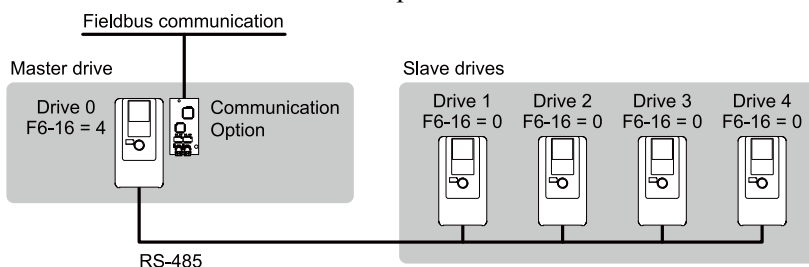

Figure 12.76 Connection Examples in Gateway Mode

Table 12.49 Specification

Item	Specification
Applicable options	All the options that support the MEMOBUS access function (for example, PROFIBUS-DP, PROFINET, EtherNet/IP, EtherCAT, etc.)
Number of connected drives	Maximum: 5 units
Communication Specifications	MEMOBUS/Modbus (RTUmode) communications
Commands/responses	The controller can send this data to each drive (Drive 0 to Drive 4): <ul style="list-style-type: none"> Control commands: Run commands and frequency references Control responses: Output frequency and drive status (during run, faults) Read and write parameters Read monitors
Synchronous control	Not supported

Note:

- The communication speed in gateway mode is slower than the speed in field bus communications. Make sure that the speed is acceptable for your system.
- Response speed with the communication option is slower than the speed with point-to-point communications.
- Set H5-03 [Communication Parity Selection] to the same value on the master drive and slave drives.

WARNING! Injury to Personnel. Separately prepare safety protection equipment and systems, for example fast stop switches. If the motor does not stop correctly from the disconnection of communications cable or electrical interference, it can cause serious injury.

Configuring Gateway Mode

[Table 12.50](#) shows sample settings to connect 4 slave drives:

Table 12.50 Sample Settings for Using Gateway Mode

	F6-16 [Gateway Mode]	H5-01 [Drive Node Address] *1	H5-02 [Communication Speed Selection] H5-03 [Communication Parity Selection]	H5-06 [Drive Transmit Wait Time]	H5-09 [CE Detection Time]	b1-01 [Frequency Reference Selection 1]	b1-02 [Run Command Selection 1]
Drive 0 (Master Drive)	1 - 4 *2	1F (Default)	*5	5 ms (factory default) *6	≥ 2.0 s *7	3 [Option PCB]	3 [Option PCB]
Drive 1 (Slave drive)	0	01 *3 *4	*5	5 ms (factory default) *6	≥ 0.9 s *7	2 [Memobus/Modbus Communications] *8	2 [Memobus/Modbus Communications] *8
Drive 2 (Slave drive)	0	02 *3 *4	*5	5 ms (factory default) *6	≥ 0.9 s *7	2 [Memobus/Modbus Communications] *8	2 [Memobus/Modbus Communications] *8
Drive 3 (Slave drive)	0	03 *3 *4	*5	5 ms (factory default) *6	≥ 0.9 s *7	2 [Memobus/Modbus Communications] *8	2 [Memobus/Modbus Communications] *8
Drive 4 (Slave drive)	0	04 *3 *4	*5	5 ms (factory default) *6	≥ 0.9 s *7	2 [Memobus/Modbus Communications] *8	2 [Memobus/Modbus Communications] *8

- *1 Restart the drive to apply the new settings.
- *2 Specify the number of slave drives you will connect.
- *3 Setting 0 will not let the drive respond to MEMOBUS/Modbus communications.
- *4 Set a slave address that is different from other slave devices.
- *5 Enter the same value that you use for the master drive.
- *6 To correctly detect the response timeout, do not change the value of H5-06 from the default value.
- *7 Set $H5-09 \geq 0.9$. When $H5-09 < 0.9$, the drive will detect *CE* [Modbus Communication Error] before it detects a response timeout.
- *8 On each slave drive, set b1-01 [Frequency Reference Selection 1] and b1-02 [Run Command Selection 1] to 2 [Memobus/Modbus Communications].

An Overview of Gateway Mode

When in gateway mode, the drive operates as shown in Table 12.51.

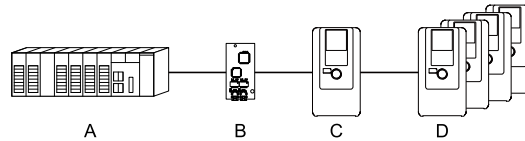

- A - Controller**
- B - Communication Option**
- C - Master Drive (Drive 0)**
- D - Slave Drives (Drives 1 to 4)**

Table 12.51 Operation in Gateway Mode

Controller to Communication Option Card	Communication Option Card to Master Drive (Drive 0)	Master Drive (Drive 0) to Slave Drives (Drives 1 to 4)
<ul style="list-style-type: none"> • The controller and card communicate in the format of each field bus communications protocol. • Drive 0 sends commands and monitors through normal field bus communications. • The special registers of Drive 0 use read and write to send commands to and monitor Drives 1 to 4. 	Field bus communication data is written to and read from the special registers of Drive 0.	<ul style="list-style-type: none"> • Uses MEMOBUS communications . • Drive 0 sends data from its special registers to Drives 1 to 4.

Operations at the Time of Communication Error

Communication Error	Error Codes	Operation
From controller to communication option	bUS	<ul style="list-style-type: none"> Master drive Detects bUS [<i>Option Communication Error</i>] and operates as specified by F6-01 [<i>Communication Error Selection</i>]. Slave drive Detects CE [<i>Modbus Communication Error</i>] and operates as specified by H5-04 [<i>Communication Error Stop Method</i>]. <p>Note:</p> <ul style="list-style-type: none"> After error detection, each drive can continue the operation specified by the last received command if the F6-01 and H5-04 settings agree. Because the controller cannot stop the operation, you must supply a stopping method, for example an emergency stop switch. If you set H5-05 = 0 [<i>Comm Fault Detection Selection = Disabled</i>], the drive will not detect CE. The H5-04 setting does not have an effect.
From communication option to master drive	oFAxx	<ul style="list-style-type: none"> Master drive Detects oFAxx and coasts to stop. Slave drive Detects hLCE [<i>High Level Communication Errors</i>] and coasts to stop.
From master drive to slave drive	CE	<p>The master drive stops communicating with the slave drive in these conditions: Reset the fault to restart communication.</p> <p>The slave drive detects CE after H5-09 [<i>CE Detection Time</i>] is expired. Then it operates in as specified with H5-04 [<i>Communication Error Stop Method</i>].</p> <ul style="list-style-type: none"> A message error occurred in the send data from the slave drive 10 consecutive times. Response from the slave drive timed out 10 consecutive times.

Gateway Special Register Specification

Table 12.52 Command Data

Register No. (Hex.)	Description	
15C5	Command source update	
	This flag enables command updates.	
	bit 0	Drive 1 Update Command Enabled
	bit 1	Drive 2 Update Command Enabled
	bit 2	Drive 3 Update Command Enabled
	bit 3	Drive 4 Update Command Enabled
	bit 4	Update Register Access Command Enabled
bit 5 - F	Reserved	
15C6	Run Command (Drive 1)	
	bit 0	H5-12 = 0: FWD/Stop 0 = Stop 1 = Forward run
		H5-12 = 1: Run/Stop 0 = Stop 1 = Run
	bit 1	H5-12 = 0: REV/Stop 0 = Stop 1 = Reverse run
		H5-12 = 1: FWD/REV 0 = Forward run 1 = Reverse run
	bit 2	External fault
	bit 3	Fault Reset
	bit 4	ComRef
bit 5	ComCtrl	
bit 6 - F	Reserved	
15C7	Frequency Reference (Drive 1)	The unit of measure changes when o1-03 changes.
15C8	Run Command (Drive 2)	
15C9	Frequency Reference (Drive 2)	
15CA	Run Command (Drive 3)	

12.7 F: Options

Register No. (Hex.)	Description	
15CB	Frequency Reference (Drive 3)	
15CC	Run Command (Drive 4)	
15CD	Frequency Reference (Drive 4)	
15CE	Slave Address for Reg. Access + Read/Write	
	bit 0 bit 1 bit 2 bit 3	Slave address 0: Broadcast Messages (MEMOBUS) 1: Drive 1 2: Drive 2 3: Drive 3 4: Drive 4 5: Broadcast Messages (run command and frequency reference)
	When bit 0 to 3 = 0, access is enabled for broadcast messages only. When bit 0 to 3 = 5, access is enabled for Run command and frequency reference broadcast messages only. Drive 0 is excluded.	
	bit 4	0: Read, 1: Write
	bit 5 - F	Reserved
15CF	Register number	
15D0	Data (write register)	

Table 12.53 Monitor Data

Register No. (Hex.)	Description		
15E7	Drive Status (Drive 1)		
	bit 0	During Run	
	bit 1	During Reverse Run	
	bit 2	Drive ready	
	bit 3	Fault	
	bit 4	Frequency Command Setting Fault	1: Upper/Lower Limit Fault
	bit 5	No response from slave	1: Response has timed out.
	bit 6	Communication Error	1: The drive detected a fault from a slave.
	bit 7	No response from slave 10 consecutive attempts.	1: Timeout occurred 10 consecutive times.
	bit 8	Communication fault occurred 10 consecutive times.	1: Fault has occurred from a slave 10 consecutive times.
	bit 9	Receive broadcast command while drive is running	1: Drive operates as specified by the broadcast message command.
	bit A	Communication error with master drive	1: The slave cannot communicate with the master because of a communication error.
	bit B - D	Reserved	
	bit E	ComRef status	
bit F	ComCtrl status		
15E8	Output frequency or frequency reference (Drive Status Bit 1: ON) (Drive 1) Drive Status Bit 4 = 0 [Output Frequency] Drive Status Bit 4 = 1 [Frequency Reference]	The unit of measure changes when <i>o1-03</i> changes.	
15E9	Drive Status (Drive 2)		
15EA	Output frequency or frequency reference (Drive Status Bit 4: ON) (Drive 2)		
15EB	Drive Status (Drive 3)		
15EC	Output frequency or frequency reference (Drive Status Bit 4: ON) (Drive 3)		
15ED	Drive Status (Drive 4)		
15EE	Output frequency or frequency reference (Drive Status Bit 4: ON) (Drive 4)		

Register No. (Hex.)	Description	
15EF	Slave Address for Reg. Access + During MEMOBUS process & ErrCode	
	bit 0	00H: MEMOBUS/Modbus Communication Complete
	bit 1	02H: Register number not registered
	bit 2	21H: Upper/Lower Limit Fault
bit 3	22H: Write Mode Error	Note: If you change the access command before the MEMOBUS/Modbus access flag turns on, the drive will not do the command from before.
bit 4	23H: Write performed during <i>Uv</i>	
bit 5	24H: Write performed while writing parameter settings	
bit 6	FFH: During MEMOBUS/Modbus Communication	
15EF	Slave address	
	bit 8	0: MEMOBUS command ignored
	bit 9	1: Drive 1
	bit A	2: Drive 2
	bit B	3: Drive 3
bit C	4: Drive 4	
bit D	5: Broadcast Messages (run command and frequency reference)	
bit E - F	Reserved	
15F0	Register number	
15F1	Data (write register)	

■ F6-01: Communication Error Selection

No. (Hex.)	Name	Description	Default (Range)
F6-01 (03A2)	Communication Error Selection	<div style="display: flex; gap: 5px;"> V/f CL-V/f OLV CLV AOLV OLV/PM AOLV/PM CLV/PM EZOLV </div> Sets the method to stop the motor or let the motor continue operating when the drive detects a <i>bUS</i> [Option Communication Error].	1 (0 - 5)

0 : Ramp to Stop

The drive ramps the motor to stop in the deceleration time. Fault relay output terminal MA-MC turns ON, and MB-MC turns OFF.

1 : Coast to Stop

The output turns off and the motor coasts to stop. Fault relay output terminal MA-MC turns ON, and MB-MC turns OFF.

2 : Fast Stop (Use C1-09)

The drive stops the motor in the deceleration time set in *C1-09* [Fast Stop Time]. Fault relay output terminal MA-MC turns ON, and MB-MC turns OFF.

3 : Alarm Only

The keypad shows *bUS* and the drive continues operation at the current frequency reference.

Note:

Separately prepare safety protection equipment and systems, for example fast stop switches.

The output terminal set for *Alarm* [*H2-01 to H2-03 = 10*] activates.

4 : Alarm (Run at d1-04)

The keypad shows *bUS* and the drive continues operation at the speed set in *d1-04* [Reference 4].

Note:

Separately prepare safety protection equipment and systems, for example fast stop switches.

5 : Alarm - Ramp Stop

The drive stops the motor in the deceleration time set in *C1-02* [Deceleration Time 1].

After you remove the *bUS* alarm, the motor will accelerate to the frequency reference you set before.

■ F6-02: Comm External Fault (EF0) Detect

No. (Hex.)	Name	Description	Default (Range)
F6-02 (03A3)	Comm External Fault (EF0) Detect	<input type="checkbox"/> V/f <input type="checkbox"/> CL-V/f <input type="checkbox"/> OLV <input type="checkbox"/> CLV <input type="checkbox"/> AOLV <input type="checkbox"/> OLVP/M <input type="checkbox"/> AOLVP/M <input type="checkbox"/> CLVP/M <input type="checkbox"/> EZOLV Sets the conditions at which <i>EF0</i> [Option Card External Fault] is detected.	0 (0, 1)

0 : Always Detected

1 : Detected during RUN Only

■ F6-03: Comm External Fault (EF0) Select

No. (Hex.)	Name	Description	Default (Range)
F6-03 (03A4)	Comm External Fault (EF0) Select	<input type="checkbox"/> V/f <input type="checkbox"/> CL-V/f <input type="checkbox"/> OLV <input type="checkbox"/> CLV <input type="checkbox"/> AOLV <input type="checkbox"/> OLVP/M <input type="checkbox"/> AOLVP/M <input type="checkbox"/> CLVP/M <input type="checkbox"/> EZOLV Sets the method to stop the motor or let the motor continue operating when the drive detects an <i>EF0</i> [Option Card External Fault].	1 (0 - 3)

0 : Ramp to Stop

The drive ramps the motor to stop in the deceleration time. Fault relay output terminal MA-MC turns ON, and MB-MC turns OFF.

1 : Coast to Stop

The output turns off and the motor coasts to stop. Fault relay output terminal MA-MC turns ON, and MB-MC turns OFF.

2 : Fast Stop (Use C1-09)

The drive stops the motor in the deceleration time set in *C1-09* [Fast Stop Time]. Fault relay output terminal MA-MC turns ON, and MB-MC turns OFF.

3 : Alarm Only

The keypad shows *EF0* and the drive continues operation.

Note:

Separately prepare safety protection equipment and systems, for example fast stop switches.

The output terminal set for *Alarm* [H2-01 to H2-03 = 10] activates.

■ F6-04: bUS Error Detection Time

No. (Hex.)	Name	Description	Default (Range)
F6-04 (03A5)	bUS Error Detection Time	<input type="checkbox"/> V/f <input type="checkbox"/> CL-V/f <input type="checkbox"/> OLV <input type="checkbox"/> CLV <input type="checkbox"/> AOLV <input type="checkbox"/> OLVP/M <input type="checkbox"/> AOLVP/M <input type="checkbox"/> CLVP/M <input type="checkbox"/> EZOLV Sets the delay time for the drive to detect <i>bUS</i> [Option Communication Error].	2.0 s (0.0 - 5.0 s)

Note:

When you install an option card in the drive, the parameter value changes to 0.0 s.

■ F6-06: Torque Reference/Limit by Comm

No. (Hex.)	Name	Description	Default (Range)
F6-06 (03A7)	Torque Reference/Limit by Comm	<input type="checkbox"/> V/f <input type="checkbox"/> CL-V/f <input type="checkbox"/> OLV <input type="checkbox"/> CLV <input type="checkbox"/> AOLV <input type="checkbox"/> OLVP/M <input type="checkbox"/> AOLVP/M <input type="checkbox"/> CLVP/M <input type="checkbox"/> EZOLV Sets the function that enables and disables the torque reference and torque limit received from the communication option.	0 (0, 1)

0 : Disabled

1 : Enabled

■ F6-07: Multi-Step Ref @ NetRef/ComRef

No. (Hex.)	Name	Description	Default (Range)
F6-07 (03A8)	Multi-Step Ref @ NetRef/ ComRef	<div style="display: flex; justify-content: space-between; gap: 5px;"> V/f CL-V/f OLV CLV AOLV OLV/PM AOLV/PM CLV/PM EZOLV </div> <p>Sets the function that enables and disables the multi-step speed reference when the frequency reference source is NetRef or ComRef (communication option card or MEMOBUS/Modbus communications).</p>	0 (0, 1)

0 : Disable Multi-Step References

When NetRef or ComRef are the frequency reference source, the multi-step speed reference (2-step speed to 16-step speed references) and the Jog Frequency Reference (JOG command) are disabled.

1 : Enable Multi-Step References

When NetRef or ComRef are the frequency reference source, the multi-step speed reference (2-step speed through 16-step speed references) and the Jog Frequency Reference (JOG command) are enabled, and you can change the frequency reference.

■ F6-08: Comm Parameter Reset @Initialize

No. (Hex.)	Name	Description	Default (Range)
F6-08 (036A)	Comm Parameter Reset @Initialize	<div style="display: flex; justify-content: space-between; gap: 5px;"> V/f CL-V/f OLV CLV AOLV OLV/PM AOLV/PM CLV/PM EZOLV </div> <p>Sets the function to initialize F6-xx and F7-xx parameters when the drive is initialized with A1-03 [Initialize Parameters].</p>	0 (0, 1)

0 : No Reset - Parameters Retained

1 : Reset Back to Factory Default

Note:

When you use A1-03 to initialize the drive, this setting will not change.

■ F6-10: CC-Link Node Address

No. (Hex.)	Name	Description	Default (Range)
F6-10 (03B6)	CC-Link Node Address	<div style="display: flex; justify-content: space-between; gap: 5px;"> V/f CL-V/f OLV CLV AOLV OLV/PM AOLV/PM CLV/PM EZOLV </div> <p>Sets the node address for CC-Link communication. Restart the drive after you change the parameter setting.</p>	0 (0 - 64)

Note:

Be sure to set a node address that is different than all other node addresses. Do not set this parameter to 0. Incorrect parameter settings will cause AEr [Station Address Setting Error] errors and the L.ERR LED on the option will come on.

When the only drive is connected, you can connect a maximum of 42 nodes. Follow these rules to connect devices that are not drives:

- $\{(1 \times a) + (2 \times b) + (3 \times c) + (4 \times d)\} \leq 64$
(a: number of units that occupies 1 node, b: number of units that occupies 2 nodes, c: number of units that occupies 3 nodes, d: number of units that occupies 4 nodes)
- $\{(16 \times A) + (54 \times B) + (88 \times C)\} \leq 2304$
(A: number of remote I/O nodes (64 max.), B: number of remote device nodes (42 max.), C: number of local nodes (26 max.))

■ F6-11: CC-Link Communication Speed

No. (Hex.)	Name	Description	Default (Range)
F6-11 (03B7)	CC-Link Communication Speed	<div style="display: flex; justify-content: space-between; gap: 5px;"> V/f CL-V/f OLV CLV AOLV OLV/PM AOLV/PM CLV/PM EZOLV </div> <p>Sets the communication speed for CC-Link communication. Restart the drive after you change the parameter setting.</p>	0 (0 - 4)

0 : 156 kbps

1 : 625 kbps

2 : 2.5 Mbps

3 : 5 Mbps**4 : 10 Mbps****■ F6-14: BUS Error Auto Reset**

No. (Hex.)	Name	Description	Default (Range)
F6-14 (03BB)	BUS Error Auto Reset	V/f CL-V/f OLV CLV AOLV OLV/PM AOLV/PM CLV/PM EZOLV Sets the automatic reset function for <i>bUS</i> [Option Communication Errors].	0 (0, 1)

0 : Disabled**1 : Enabled****■ F6-15: Comm. Option Parameters Reload**

No. (Hex.)	Name	Description	Default (Range)
F6-15 (0B5B)	Comm. Option Parameters Reload	V/f CL-V/f OLV CLV AOLV OLV/PM AOLV/PM CLV/PM EZOLV Sets the update method when you change <i>F6-xx, F7-xx</i> [Communication Options].	0 (0 - 2)

Note:

- Set *F6-15* = 0, 1 to reload *F6-xx, F7-xx*.
- Set *F6-15* = 0, 1 to reset the display on the keypad to 0.

0 : Reload at Next Power Cycle

Restart the drive to update parameters.

1 : Reload Now

The changed parameters are updated without restarting the drive.

2 : Cancel Reload RequestCancels *CyPo* [Cycle Power to Accept Changes].**■ F6-16: Gateway Mode**

No. (Hex.)	Name	Description	Default (Range)
F6-16 (0B8A)	Gateway Mode	V/f CL-V/f OLV CLV AOLV OLV/PM AOLV/PM CLV/PM EZOLV Sets the gateway mode operation and the number of connected slave drives.	0 (0 to 4)

0 : Disabled**1 : Enabled: 1 Slave Drives****2 : Enabled: 2 Slave Drives****3 : Enabled: 3 Slave Drives****4 : Enabled: 4 Slave Drives****■ F6-20: MECHATROLINK Station Address**

No. (Hex.)	Name	Description	Default (Range)
F6-20 (036B)	MECHATROLINK Station Address	V/f CL-V/f OLV CLV AOLV OLV/PM AOLV/PM CLV/PM EZOLV Sets the station address for MECHATROLINK communication. Restart the drive after you change the parameter setting.	0021h (MECHATROLINK-II: 0020h - 003Fh, MECHATROLINK-III: 0003h - 00EFh)

Note:

- The setting range changes if using MECHATROLINK-II or MECHATROLINK-III:
 - MECHATROLINK-II (SI-T3) range: 20 to 3F
 - MECHATROLINK-III (SI-ET3) range: 03 to EF
- Be sure to set a node address that is different than all other node addresses. Incorrect parameter settings will cause *AEr* [Station Address Setting Error] errors and the L.ERR LED on the option will come on.
- The drive detects *AEr* errors when the station address is 20 or 3F.

■ F6-21: MECHATROLINK Frame Size

No. (Hex.)	Name	Description	Default (Range)
F6-21 (036C)	MECHATROLINK Frame Size	<div style="display: flex; justify-content: space-between; font-size: 0.8em;"> V/f CL-V/f OLV CLV AOLV OLV/PM AOLV/PM CLV/PM EZOLV </div> <p>Sets the frame size for MECHATROLINK communication. Restart the drive after you change the parameter setting.</p>	0 (0, 1)

0 : 32byte (M-2) / 64byte (M-3)

1 : 17byte (M-2) / 32byte (M-3)

■ F6-22: MECHATROLINK Link Speed

No. (Hex.)	Name	Description	Default (Range)
F6-22 (036D)	MECHATROLINK Link Speed	<div style="display: flex; justify-content: space-between; font-size: 0.8em;"> V/f CL-V/f OLV CLV AOLV OLV/PM AOLV/PM CLV/PM EZOLV </div> <p>Sets the communications speed for MECHATROLINK-II. Restart the drive after you change the parameter setting.</p>	0 (0, 1)

Note:

This parameter is only available with the MECHATROLINK-II option.

0 : 10 Mbps

1 : 4 Mbps

■ F6-23: MECHATROLINK Monitor Select (E)

No. (Hex.)	Name	Description	Default (Range)
F6-23 (036E)	MECHATROLINK Monitor Select (E)	<div style="display: flex; justify-content: space-between; font-size: 0.8em;"> V/f CL-V/f OLV CLV AOLV OLV/PM AOLV/PM CLV/PM EZOLV </div> <p>Sets the MEMOBUS register used for the monitor functions of INV_CTL (drive operation control command) and INV_I/O (drive I/O control command). Restart the drive after you change the parameter setting.</p>	0000h (0000h - FFFFh)

To enable the MEMOBUS register set in *F6-23*, set SEL_MON2/1 to 0EH or set SEL_MON 3/4 and SEL_MON 5/6 to 0EH. Bytes of the response data enable the MEMOBUS register content that was set in *F6-23*.

■ F6-24: MECHATROLINK Monitor Select (F)

No. (Hex.)	Name	Description	Default (Range)
F6-24 (036F)	MECHATROLINK Monitor Select (F)	<div style="display: flex; justify-content: space-between; font-size: 0.8em;"> V/f CL-V/f OLV CLV AOLV OLV/PM AOLV/PM CLV/PM EZOLV </div> <p>Sets the MEMOBUS register used for the monitor functions of INV_CTL (drive operation control command) and INV_I/O (drive I/O control command). Restart the drive after you change the parameter setting.</p>	0000h (0000h - FFFFh)

To enable the MEMOBUS register set in *F6-24*, set SEL_MON2/1 to 0FH or set SEL_MON3/4 and SEL_MON 5/6 to 0FH. Bytes of the response data enable the MEMOBUS register content that was set *F6-24*.

■ F6-25: MECHATROLINK Watchdog Error Sel

No. (Hex.)	Name	Description	Default (Range)
F6-25 (03C9)	MECHATROLINK Watchdog Error Sel	<div style="display: flex; justify-content: space-between; font-size: 0.8em;"> V/f CL-V/f OLV CLV AOLV OLV/PM AOLV/PM CLV/PM EZOLV </div> <p>Sets the method to stop the motor or let the motor continue operating when the drive detects an <i>E5</i> [MECHATROLINK Watchdog Timer Err].</p>	1 (0 - 3)

0 : Ramp to Stop

The drive ramps the motor to stop in the deceleration time. Fault relay output terminal MA-MC turns ON, and MB-MC turns OFF.

1 : Coast to Stop

The output turns off and the motor coasts to stop. Fault relay output terminal MA-MC turns ON, and MB-MC turns OFF.

2 : Fast Stop (Use C1-09)

The drive stops the motor in the deceleration time set in *C1-09 [Fast Stop Time]*. Fault relay output terminal MA-MC turns ON, and MB-MC turns OFF.

3 : Alarm Only

The keypad shows *E5*, and the drive continues to operate.

Note:

Separately prepare safety protection equipment and systems, for example fast stop switches.

The output terminal set for *Alarm [H2-01 to H2-03 = 10]* activates.

■ **F6-26: MECHATROLINK Allowable No of Err**

No. (Hex.)	Name	Description	Default (Range)
F6-26 (03CA)	MECHATROLINK Allowable No of Err	<div style="display: flex; justify-content: space-between; font-size: 0.8em;"> V/f CL-V/f OLV CLV AOLV OLV/PM AOLV/PM CLV/PM EZOLV </div> <p>Sets the number of times that the option must detect a <i>bUS</i> alarm to cause a <i>bUS [Option Communication Error]</i>.</p>	2 (2 - 10 times)

■ **F6-30: PROFIBUS-DP Node Address**

No. (Hex.)	Name	Description	Default (Range)
F6-30 (03CB)	PROFIBUS-DP Node Address	<div style="display: flex; justify-content: space-between; font-size: 0.8em;"> V/f CL-V/f OLV CLV AOLV OLV/PM AOLV/PM CLV/PM EZOLV </div> <p>Sets the node address for PROFIBUS-DP communication. Restart the drive after you change the parameter setting.</p>	0 (0 - 125)

Note:

- Be sure to set a node address that is different than all other node addresses.
- Node addresses 0, 1, and 2 are usually reserved for control, maintenance, and device self-diagnosis.

■ **F6-31: PROFIBUS-DP Clear Mode Selection**

No. (Hex.)	Name	Description	Default (Range)
F6-31 (03CC)	PROFIBUS-DP Clear Mode Selection	<div style="display: flex; justify-content: space-between; font-size: 0.8em;"> V/f CL-V/f OLV CLV AOLV OLV/PM AOLV/PM CLV/PM EZOLV </div> <p>Sets what the drive will do after it receives the Clear Mode command.</p>	0 (0, 1)

0 : Reset

Resets drive settings, for example frequency reference and I/O settings.

1 : Hold Previous State

The drive keeps the same status as before it received the command.

■ **F6-32: PROFIBUS-DP Data Format Select**

No. (Hex.)	Name	Description	Default (Range)
F6-32 (03CD)	PROFIBUS-DP Data Format Select	<div style="display: flex; justify-content: space-between; font-size: 0.8em;"> V/f CL-V/f OLV CLV AOLV OLV/PM AOLV/PM CLV/PM EZOLV </div> <p>Sets the data format of PROFIBUS-DP communication. Restart the drive after you change the parameter setting.</p>	0 (0 - 5)

Note:

The *H5-11 [Comm ENTER Command Mode]* setting makes the RAM enter command necessary or not necessary to write parameters over network communication. When *F6-32 = 0, 1, or 2*, the *H5-11* setting does not have an effect. The RAM enter command is always necessary to write parameters.

0 : PPO Type

1 : Conventional

2 : PPO (bit0)

This function operates when bit 0 and bit 4 in the register STW have values of 1 (operate). Refer to the PROFIBUS-DP communication manual for more information.

3 : PPO (Enter)

4 : Conventional (Enter)

5 : PPO (bit0, Enter)

This function operates when bit 0 and bit 4 in the register STW have values of 1 (operate). Refer to the PROFIBUS-DP communication manual for more information.

■ F6-35: CANopen Node ID Selection

No. (Hex.)	Name	Description	Default (Range)
F6-35 (03D0)	CANopen Node ID Selection	<input type="checkbox"/> V/f <input type="checkbox"/> CL-V/f <input type="checkbox"/> OLV <input type="checkbox"/> CLV <input type="checkbox"/> AOLV <input type="checkbox"/> OLV/PM <input type="checkbox"/> AOLV/PM <input type="checkbox"/> CLV/PM <input type="checkbox"/> EZOLV Sets the node address for CANopen communication. Restart the drive after you change the parameter setting.	0 (0 - 126)

Note:

Be sure to set an address that is different than all other node addresses. Do not set this parameter to 0. Incorrect parameter settings will cause *LEr [Station Address Setting Error]* errors and the L.ERR LED on the option will come on.

■ F6-36: CANopen Communication Speed

No. (Hex.)	Name	Description	Default (Range)
F6-36 (03D1)	CANopen Communication Speed	<input type="checkbox"/> V/f <input type="checkbox"/> CL-V/f <input type="checkbox"/> OLV <input type="checkbox"/> CLV <input type="checkbox"/> AOLV <input type="checkbox"/> OLV/PM <input type="checkbox"/> AOLV/PM <input type="checkbox"/> CLV/PM <input type="checkbox"/> EZOLV Sets the CANopen communications speed. Restart the drive after you change the parameter setting.	6 (0 - 8)

0 : Auto-detection

The drive detects the network communication speed and automatically adjusts the communications speed.

1 : 10 kbps**2 : 20 kbps****3 : 50 kbps****4 : 125 kbps****5 : 250 kbps****6 : 500 kbps****7 : 800 kbps****8 : 1 Mbps****■ F6-45: BACnet Node Address**

No. (Hex.)	Name	Description	Default (Range)
F6-45 (02FB)	BACnet Node Address	<input type="checkbox"/> V/f <input type="checkbox"/> CL-V/f <input type="checkbox"/> OLV <input type="checkbox"/> CLV <input type="checkbox"/> AOLV <input type="checkbox"/> OLV/PM <input type="checkbox"/> AOLV/PM <input type="checkbox"/> CLV/PM <input type="checkbox"/> EZOLV Sets the node address for BACnet communication.	1 (0 - 127)

■ F6-46: BACnet Baud Rate

No. (Hex.)	Name	Description	Default (Range)
F6-46 (02FC)	BACnet Baud Rate	<input type="checkbox"/> V/f <input type="checkbox"/> CL-V/f <input type="checkbox"/> OLV <input type="checkbox"/> CLV <input type="checkbox"/> AOLV <input type="checkbox"/> OLV/PM <input type="checkbox"/> AOLV/PM <input type="checkbox"/> CLV/PM <input type="checkbox"/> EZOLV Sets the BACnet communications speed.	3 (0 - 8)

0 : 1200 bps**1 : 2400 bps****2 : 4800 bps****3 : 9600 bps****4 : 19.2 kbps****5 : 38.4 kbps****6 : 57.6 kbps****7 : 76.8 kbps****8 : 115.2 kbps**

■ F6-47: Rx to Tx Wait Time

No. (Hex.)	Name	Description	Default (Range)
F6-47 (02FD)	Rx to Tx Wait Time	<input type="checkbox"/> V/f <input type="checkbox"/> CL-V/f <input type="checkbox"/> OLV <input type="checkbox"/> CLV <input type="checkbox"/> AOLV <input type="checkbox"/> OLVP/M <input type="checkbox"/> AOLVP/M <input type="checkbox"/> CLVP/M <input type="checkbox"/> EZOLV Sets the wait time for the drive to receive and send BACnet communication.	5 ms (5 - 65 ms)

■ F6-48: BACnet Device Object Identifier0

No. (Hex.)	Name	Description	Default (Range)
F6-48 (02FE)	BACnet Device Object Identifier0	<input type="checkbox"/> V/f <input type="checkbox"/> CL-V/f <input type="checkbox"/> OLV <input type="checkbox"/> CLV <input type="checkbox"/> AOLV <input type="checkbox"/> OLVP/M <input type="checkbox"/> AOLVP/M <input type="checkbox"/> CLVP/M <input type="checkbox"/> EZOLV Sets the last word of BACnet communication addresses.	0 (0 - FFFF)

■ F6-49: BACnet Device Object Identifier1

No. (Hex.)	Name	Description	Default (Range)
F6-49 (02FF)	BACnet Device Object Identifier1	<input type="checkbox"/> V/f <input type="checkbox"/> CL-V/f <input type="checkbox"/> OLV <input type="checkbox"/> CLV <input type="checkbox"/> AOLV <input type="checkbox"/> OLVP/M <input type="checkbox"/> AOLVP/M <input type="checkbox"/> CLVP/M <input type="checkbox"/> EZOLV Sets the last word of BACnet communication addresses.	0 (0 - 3F)

■ F6-50: DeviceNet MAC Address

No. (Hex.)	Name	Description	Default (Range)
F6-50 (03C1)	DeviceNet MAC Address	<input type="checkbox"/> V/f <input type="checkbox"/> CL-V/f <input type="checkbox"/> OLV <input type="checkbox"/> CLV <input type="checkbox"/> AOLV <input type="checkbox"/> OLVP/M <input type="checkbox"/> AOLVP/M <input type="checkbox"/> CLVP/M <input type="checkbox"/> EZOLV Sets the MAC address for DeviceNet communication. Restart the drive after you change the parameter setting.	64 (0 - 64)

Note:

Be sure to set a MAC address that is different than all other node addresses. Do not set this parameter to 0. Incorrect parameter settings will cause *AEr* [Station Address Setting Error] errors and the MS LED on the option will flash.

■ F6-51: DeviceNet Baud Rate

No. (Hex.)	Name	Description	Default (Range)
F6-51 (03C2)	DeviceNet Baud Rate	<input type="checkbox"/> V/f <input type="checkbox"/> CL-V/f <input type="checkbox"/> OLV <input type="checkbox"/> CLV <input type="checkbox"/> AOLV <input type="checkbox"/> OLVP/M <input type="checkbox"/> AOLVP/M <input type="checkbox"/> CLVP/M <input type="checkbox"/> EZOLV Sets the DeviceNet communications speed. Restart the drive after you change the parameter setting.	4 (0 - 4)

0 : 125 kbps

1 : 250 kbps

2 : 500 kbps

3 : Adjustable from Network

The controller sets the communications speed.

4 : Detect Automatically

The drive detects the network communication speed and automatically adjusts the communications speed.

■ F6-52: DeviceNet PCA Setting

No. (Hex.)	Name	Description	Default (Range)
F6-52 (03C3)	DeviceNet PCA Setting	<input type="checkbox"/> V/f <input type="checkbox"/> CL-V/f <input type="checkbox"/> OLV <input type="checkbox"/> CLV <input type="checkbox"/> AOLV <input type="checkbox"/> OLVP/M <input type="checkbox"/> AOLVP/M <input type="checkbox"/> CLVP/M <input type="checkbox"/> EZOLV Sets the format of data that the DeviceNet communication master sends to the drive.	21 (0 - 255)

Note:

If F6-52 [DeviceNet PCA Setting] and F6-53 [DeviceNet PPA Setting] are not correct, the value is reset to default.

■ F6-53: DeviceNet PPA Setting

No. (Hex.)	Name	Description	Default (Range)
F6-53 (03C4)	DeviceNet PPA Setting	<div style="display: flex; justify-content: space-between; gap: 5px;"> V/f CL-V/f OLV CLV AOLV OLV/PM AOLV/PM CLV/PM EZOLV </div> Sets the format of data that the drive sends to the DeviceNet communication master.	71 (0 - 255)

Note:

If F6-52 [DeviceNet PCA Setting] and F6-53 [DeviceNet PPA Setting] are not correct, the value is reset to default.

■ F6-54: DeviceNet Idle Fault Detection

No. (Hex.)	Name	Description	Default (Range)
F6-54 (03C5)	DeviceNet Idle Fault Detection	<div style="display: flex; justify-content: space-between; gap: 5px;"> V/f CL-V/f OLV CLV AOLV OLV/PM AOLV/PM CLV/PM EZOLV </div> Sets the function to detect <i>EF0</i> [Option Card External Fault] when the drive does not receive data from the DeviceNet master.	0 (0 - 4)

0 : Enabled

1 : Disabled, No Fault Detection

Does not detect *EF0* issues.

2 : Vendor Specific

3 : RUN Forward

4 : RUN Reverse

■ F6-55: DeviceNet Baud Rate Monitor

No. (Hex.)	Name	Description	Default (Range)
F6-55 (03C6)	DeviceNet Baud Rate Monitor	<div style="display: flex; justify-content: space-between; gap: 5px;"> V/f CL-V/f OLV CLV AOLV OLV/PM AOLV/PM CLV/PM EZOLV </div> Sets the function to see the actual DeviceNet communications speed using the keypad. This parameter functions as a monitor only.	0 (0 - 2)

0 : 125 kbps

1 : 250 kbps

2 : 500 kbps

■ F6-56: DeviceNet Speed Scaling

No. (Hex.)	Name	Description	Default (Range)
F6-56 (03D7)	DeviceNet Speed Scaling	<div style="display: flex; justify-content: space-between; gap: 5px;"> V/f CL-V/f OLV CLV AOLV OLV/PM AOLV/PM CLV/PM EZOLV </div> Sets the speed scale for DeviceNet communication.	0 (-15 - +15)

■ F6-57: DeviceNet Current Scaling

No. (Hex.)	Name	Description	Default (Range)
F6-57 (03D8)	DeviceNet Current Scaling	<div style="display: flex; justify-content: space-between; gap: 5px;"> V/f CL-V/f OLV CLV AOLV OLV/PM AOLV/PM CLV/PM EZOLV </div> Sets the current scale of the DeviceNet communication master.	0 (-15 - +15)

■ F6-58: DeviceNet Torque Scaling

No. (Hex.)	Name	Description	Default (Range)
F6-58 (03D9)	DeviceNet Torque Scaling	<div style="display: flex; justify-content: space-between; gap: 5px;"> V/f CL-V/f OLV CLV AOLV OLV/PM AOLV/PM CLV/PM EZOLV </div> Sets the torque scale of the DeviceNet communication master.	0 (-15 - +15)

■ F6-59: DeviceNet Power Scaling

No. (Hex.)	Name	Description	Default (Range)
F6-59 (03DA)	DeviceNet Power Scaling	<div style="display: flex; gap: 5px;"> V/f CL-V/f OLV CLV AOLV OLV/PM AOLV/PM CLV/PM EZOLV </div> Sets the power scale of the DeviceNet communication master.	0 (-15 - +15)

■ F6-60: DeviceNet Voltage Scaling

No. (Hex.)	Name	Description	Default (Range)
F6-60 (03DB)	DeviceNet Voltage Scaling	<div style="display: flex; gap: 5px;"> V/f CL-V/f OLV CLV AOLV OLV/PM AOLV/PM CLV/PM EZOLV </div> Sets the voltage scale of the DeviceNet communication master.	0 (-15 - +15)

■ F6-61: DeviceNet Time Scaling

No. (Hex.)	Name	Description	Default (Range)
F6-61 (03DC)	DeviceNet Time Scaling	<div style="display: flex; gap: 5px;"> V/f CL-V/f OLV CLV AOLV OLV/PM AOLV/PM CLV/PM EZOLV </div> Sets the time scale of the DeviceNet communication master.	0 (-15 - +15)

■ F6-62: DeviceNet Heartbeat Interval

No. (Hex.)	Name	Description	Default (Range)
F6-62 (03DD)	DeviceNet Heartbeat Interval	<div style="display: flex; gap: 5px;"> V/f CL-V/f OLV CLV AOLV OLV/PM AOLV/PM CLV/PM EZOLV </div> Sets the heartbeat for DeviceNet communication. Set this parameter to 0 to disable the heartbeat function.	0 (0 - 10)

■ F6-63: DeviceNet Network MAC ID

No. (Hex.)	Name	Description	Default (Range)
F6-63 (03DE)	DeviceNet Network MAC ID	<div style="display: flex; gap: 5px;"> V/f CL-V/f OLV CLV AOLV OLV/PM AOLV/PM CLV/PM EZOLV </div> Sets the function to see the actual DeviceNet MAC address using the keypad. This parameter functions as a monitor only.	63 (0 - 63)

■ F6-64 to F6-67: Dynamic Out Assembly 109 Param1 to 4

No. (Hex.)	Name	Description	Default (Range)
F6-64 to F6-67 (03DF - 03E2)	Dynamic Out Assembly 109 Param 1 to 4	<div style="display: flex; gap: 5px;"> V/f CL-V/f OLV CLV AOLV OLV/PM AOLV/PM CLV/PM EZOLV </div> Sets Configurable Outputs 1 to 4 written to the MEMOBUS register.	0000h (0000h - FFFFh)

■ F6-68 to F6-71: Dynamic In Assembly 159 Param 1 to 4

No. (Hex.)	Name	Description	Default (Range)
F6-68 to F6-71 (03E3, 03E4, 03C7, and 03C8)	Dynamic In Assembly 159 Param 1 to 4	<div style="display: flex; gap: 5px;"> V/f CL-V/f OLV CLV AOLV OLV/PM AOLV/PM CLV/PM EZOLV </div> Sets Configurable Inputs 1 to 4 written to the MEMOBUS register.	0000h (0000h - FFFFh)

■ F6-72: PowerLink Node Address

No. (Hex.)	Name	Description	Default (Range)
F6-72 (081B)	PowerLink Node Address	<div style="display: flex; gap: 5px;"> V/f CL-V/f OLV CLV AOLV OLV/PM AOLV/PM CLV/PM EZOLV </div> Sets the node ID for PowerLink communication.	0 (0 - 255)

■ F7-01: IP Address 1

No. (Hex.)	Name	Description	Default (Range)
F7-01 (03E5)	IP Address 1	<div style="display: flex; justify-content: space-between; font-size: 0.8em; font-weight: bold;"> V/f CL-V/f OLV CLV AOLV OLV/PM AOLV/PM CLV/PM EZOLV </div> <p>Sets the first octet of the IP Address for the device that is connecting to the network. Restart the drive after you change this parameter.</p>	192 (0 - 255)

Note:

When $F7-13 = 0$ [Address Mode at Startup = Static]:

- Use parameters $F7-01$ to $F7-04$ [IP Address 4] to set the IP Address. Be sure to set a different IP address for each drive on the network.
- Also set parameters $F7-01$ to $F7-12$.

■ F7-02: IP Address 2

No. (Hex.)	Name	Description	Default (Range)
F7-02 (03E6)	IP Address 2	<div style="display: flex; justify-content: space-between; font-size: 0.8em; font-weight: bold;"> V/f CL-V/f OLV CLV AOLV OLV/PM AOLV/PM CLV/PM EZOLV </div> <p>Sets the second octet of the IP Address for the device that is connecting to the network. Restart the drive after you change this parameter.</p>	168 (0 - 255)

Note:

When $F7-13 = 0$ [Address Mode at Startup = Static]:

- Use parameters $F7-01$ to $F7-04$ [IP Address 4] to set the IP Address. Be sure to set a different IP address for each drive on the network.
- Also set parameters $F7-01$ to $F7-12$.

■ F7-03: IP Address 3

No. (Hex.)	Name	Description	Default (Range)
F7-03 (03E7)	IP Address 3	<div style="display: flex; justify-content: space-between; font-size: 0.8em; font-weight: bold;"> V/f CL-V/f OLV CLV AOLV OLV/PM AOLV/PM CLV/PM EZOLV </div> <p>Sets the third octet of the IP Address for the device that is connecting to the network. Restart the drive after you change this parameter.</p>	1 (0 - 255)

Note:

When $F7-13 = 0$ [Address Mode at Startup = Static]:

- Use parameters $F7-01$ to $F7-04$ [IP Address 4] to set the IP Address. Be sure to set a different IP address for each drive on the network.
- Also set parameters $F7-01$ to $F7-12$.

■ F7-04: IP Address 4

No. (Hex.)	Name	Description	Default (Range)
F7-04 (03E8)	IP Address 4	<div style="display: flex; justify-content: space-between; font-size: 0.8em; font-weight: bold;"> V/f CL-V/f OLV CLV AOLV OLV/PM AOLV/PM CLV/PM EZOLV </div> <p>Sets the fourth octet of the IP Address for the device that is connecting to the network. Restart the drive after you change this parameter.</p>	20 (0 - 255)

Note:

When $F7-13 = 0$ [Address Mode at Startup = Static]:

- Use parameters $F7-01$ to $F7-04$ [IP Address 4] to set the IP Address. Be sure to set a different IP address for each drive on the network.
- Also set parameters $F7-01$ to $F7-12$.

■ F7-05: Subnet Mask 1

No. (Hex.)	Name	Description	Default (Range)
F7-05 (03E9)	Subnet Mask 1	<div style="display: flex; justify-content: space-between; font-size: 0.8em; font-weight: bold;"> V/f CL-V/f OLV CLV AOLV OLV/PM AOLV/PM CLV/PM EZOLV </div> <p>Sets the first octet of the subnet mask of the connected network.</p>	255 (0 - 255)

Note:

Set this parameter when $F7-13 = 0$ [Address Mode at Startup = Static].

■ F7-06: Subnet Mask 2

No. (Hex.)	Name	Description	Default (Range)
F7-06 (03EA)	Subnet Mask 2	<div style="display: flex; justify-content: space-between; font-size: 0.8em; font-weight: bold;"> V/f CL-V/f OLV CLV AOLV OLV/PM AOLV/PM CLV/PM EZOLV </div> Sets the second octet of the subnet mask of the connected network.	255 (0 - 255)

Note:

Set this parameter when $F7-13 = 0$ [Address Mode at Startup = Static].

■ F7-07: Subnet Mask 3

No. (Hex.)	Name	Description	Default (Range)
F7-07 (03EB)	Subnet Mask 3	<div style="display: flex; justify-content: space-between; font-size: 0.8em; font-weight: bold;"> V/f CL-V/f OLV CLV AOLV OLV/PM AOLV/PM CLV/PM EZOLV </div> Sets the third octet of the subnet mask of the connected network.	255 (0 - 255)

Note:

Set this parameter when $F7-13 = 0$ [Address Mode at Startup = Static].

■ F7-08: Subnet Mask 4

No. (Hex.)	Name	Description	Default (Range)
F7-08 (03EC)	Subnet Mask 4	<div style="display: flex; justify-content: space-between; font-size: 0.8em; font-weight: bold;"> V/f CL-V/f OLV CLV AOLV OLV/PM AOLV/PM CLV/PM EZOLV </div> Sets the fourth octet of the subnet mask of the connected network.	0 (0 - 255)

Note:

Set this parameter when $F7-13 = 0$ [Address Mode at Startup = Static].

■ F7-09: Gateway Address 1

No. (Hex.)	Name	Description	Default (Range)
F7-09 (03ED)	Gateway Address 1	<div style="display: flex; justify-content: space-between; font-size: 0.8em; font-weight: bold;"> V/f CL-V/f OLV CLV AOLV OLV/PM AOLV/PM CLV/PM EZOLV </div> Sets the first octet of the gateway address of the connected network.	192 (0 - 255)

Note:

Set this parameter when $F7-13 = 0$ [Address Mode at Startup = Static].

■ F7-10: Gateway Address 2

No. (Hex.)	Name	Description	Default (Range)
F7-10 (03EE)	Gateway Address 2	<div style="display: flex; justify-content: space-between; font-size: 0.8em; font-weight: bold;"> V/f CL-V/f OLV CLV AOLV OLV/PM AOLV/PM CLV/PM EZOLV </div> Sets the second octet of the gateway address of the connected network.	168 (0 - 255)

Note:

Set this parameter when $F7-13 = 0$ [Address Mode at Startup = Static].

■ F7-11: Gateway Address 3

No. (Hex.)	Name	Description	Default (Range)
F7-11 (03EF)	Gateway Address 3	<div style="display: flex; justify-content: space-between; font-size: 0.8em; font-weight: bold;"> V/f CL-V/f OLV CLV AOLV OLV/PM AOLV/PM CLV/PM EZOLV </div> Sets the third octet of the gateway address of the connected network.	1 (0 - 255)

Note:

Set this parameter when $F7-13 = 0$ [Address Mode at Startup = Static].

■ F7-12: Gateway Address 4

No. (Hex.)	Name	Description	Default (Range)
F7-12 (03F0)	Gateway Address 4	<div style="display: flex; justify-content: space-between; gap: 5px;"> V/f CL-V/f OLV CLV AOLV OLV/PM AOLV/PM CLV/PM EZOLV </div> Sets the fourth octet of the gateway address of the connected network.	1 (0 - 255)

Note:

Set this parameter when $F7-13 = 0$ [Address Mode at Startup = Static].

■ F7-13: Address Mode at Startup

No. (Hex.)	Name	Description	Default (Range)
F7-13 (03F1)	Address Mode at Startup	<div style="display: flex; justify-content: space-between; gap: 5px;"> V/f CL-V/f OLV CLV AOLV OLV/PM AOLV/PM CLV/PM EZOLV </div> Sets the method to set option card IP addresses.	2 (0 - 2)

0 : Static

1 : BOOTP

2 : DHCP

Note:

• The following setting values are available when using the PROFINET communication option card (SI-EP3).

–0: Static

–2: DCP

• When $F7-13 = 0$, set parameters $F7-01$ to $F7-12$ [IP Address 1 to Gateway Address 4] to set the IP Address. Be sure to set a different IP address for each drive on the network.

■ F7-14: Duplex Mode Selection

No. (Hex.)	Name	Description	Default (Range)
F7-14 (03F2)	Duplex Mode Selection	<div style="display: flex; justify-content: space-between; gap: 5px;"> V/f CL-V/f OLV CLV AOLV OLV/PM AOLV/PM CLV/PM EZOLV </div> Sets the duplex mode setting method.	1 (0 - 8)

0 : Half/Half

1 : Auto/Auto

2 : Full/Full

3 : Half/Auto

Port 1 is set to “Half” and port 2 is set to “Auto”.

4 : Half/Full

Port 1 is set to “Half” and port 2 is set to “Full”.

5 : Auto/Half

Port 1 is set to “Auto” and port 2 is set to “Half”.

6 : Auto/Full

Port 1 is set to “Auto” and port 2 is set to “Full”.

7 : Full/Half

Port 1 is set to “Full” and port 2 is set to “Half”.

8 : Full/Auto

Port 1 is set to “Full” and port 2 is set to “Auto”.

■ F7-15: Communication Speed Selection

No. (Hex.)	Name	Description	Default (Range)
F7-15 (03F3)	Communication Speed Selection	<div style="display: flex; justify-content: space-between; gap: 5px;"> V/f CL-V/f OLV CLV AOLV OLV/PM AOLV/PM CLV/PM EZOLV </div> Sets the communications speed.	10 (10, 100 - 102)

10 : 10/10 Mbps**100 : 100/100 Mbps****101 : 10/100 Mbps****102 : 100/10 Mbps****Note:**Set this parameter when $F7-14 = 0$ or 2 [Duplex Mode Selection = Half/Half or Full/Full].**■ F7-16: Timeout Value**

No. (Hex.)	Name	Description	Default (Range)
F7-16 (03F4)	Timeout Value	<input type="checkbox"/> V/f <input type="checkbox"/> CL-V/f <input type="checkbox"/> OLV <input type="checkbox"/> CLV <input type="checkbox"/> AOLV <input type="checkbox"/> OL/PM <input type="checkbox"/> AOL/PM <input type="checkbox"/> CLV/PM <input type="checkbox"/> EZOLV Sets the detection time for a communications timeout.	0.0 s (0.0 - 30.0 s)

Note:

Set this parameter to 0.0 to disable the connection timeout function.

■ F7-17: EtherNet/IP Speed Scaling Factor

No. (Hex.)	Name	Description	Default (Range)
F7-17 (03F5)	EtherNet/IP Speed Scaling Factor	<input type="checkbox"/> V/f <input type="checkbox"/> CL-V/f <input type="checkbox"/> OLV <input type="checkbox"/> CLV <input type="checkbox"/> AOLV <input type="checkbox"/> OL/PM <input type="checkbox"/> AOL/PM <input type="checkbox"/> CLV/PM <input type="checkbox"/> EZOLV Sets the scaling factor for the speed monitor in the EtherNet/IP Class ID 2AH Object.	0 (-15 - +15)

■ F7-18: EtherNet/IP Current Scale Factor

No. (Hex.)	Name	Description	Default (Range)
F7-18 (03F6)	EtherNet/IP Current Scale Factor	<input type="checkbox"/> V/f <input type="checkbox"/> CL-V/f <input type="checkbox"/> OLV <input type="checkbox"/> CLV <input type="checkbox"/> AOLV <input type="checkbox"/> OL/PM <input type="checkbox"/> AOL/PM <input type="checkbox"/> CLV/PM <input type="checkbox"/> EZOLV Sets the scaling factor for the output current monitor in the EtherNet/IP Class ID 2AH Object.	0 (-15 - +15)

■ F7-19: EtherNet/IP Torque Scale Factor

No. (Hex.)	Name	Description	Default (Range)
F7-19 (03F7)	EtherNet/IP Torque Scale Factor	<input type="checkbox"/> V/f <input type="checkbox"/> CL-V/f <input type="checkbox"/> OLV <input type="checkbox"/> CLV <input type="checkbox"/> AOLV <input type="checkbox"/> OL/PM <input type="checkbox"/> AOL/PM <input type="checkbox"/> CLV/PM <input type="checkbox"/> EZOLV Sets the scaling factor for the torque monitor in the EtherNet/IP Class ID 2AH Object.	0 (-15 - +15)

■ F7-20: EtherNet/IP Power Scaling Factor

No. (Hex.)	Name	Description	Default (Range)
F7-20 (03F8)	EtherNet/IP Power Scaling Factor	<input type="checkbox"/> V/f <input type="checkbox"/> CL-V/f <input type="checkbox"/> OLV <input type="checkbox"/> CLV <input type="checkbox"/> AOLV <input type="checkbox"/> OL/PM <input type="checkbox"/> AOL/PM <input type="checkbox"/> CLV/PM <input type="checkbox"/> EZOLV Sets the scaling factor for the power monitor in the EtherNet/IP Class ID 2AH Object.	0 (-15 - +15)

■ F7-21: EtherNet/IP Voltage Scale Factor

No. (Hex.)	Name	Description	Default (Range)
F7-21 (03F9)	EtherNet/IP Voltage Scale Factor	<input type="checkbox"/> V/f <input type="checkbox"/> CL-V/f <input type="checkbox"/> OLV <input type="checkbox"/> CLV <input type="checkbox"/> AOLV <input type="checkbox"/> OL/PM <input type="checkbox"/> AOL/PM <input type="checkbox"/> CLV/PM <input type="checkbox"/> EZOLV Sets the scaling factor for the voltage monitor in the EtherNet/IP Class ID 2AH Object.	0 (-15 - +15)

■ F7-22: EtherNet/IP Time Scaling

No. (Hex.)	Name	Description	Default (Range)
F7-22 (03FA)	EtherNet/IP Time Scaling	<input type="checkbox"/> V/f <input type="checkbox"/> CL-V/f <input type="checkbox"/> OLV <input type="checkbox"/> CLV <input type="checkbox"/> AOLV <input type="checkbox"/> OL/PM <input type="checkbox"/> AOL/PM <input type="checkbox"/> CLV/PM <input type="checkbox"/> EZOLV Sets the scaling factor for the time monitor in the EtherNet/IP Class ID 2AH Object.	0 (-15 - +15)

■ F7-23 to F7-32: Dynamic Out Param 1 to 10 for CommCard

No. (Hex.)	Name	Description	Default (Range)
F7-23 - F7-27 (03FB - 03FF) F7-28- F7-32 (0370 - 0374)	Dynamic Out Param 1 to 10 for CommCard	<p>V/f CL-V/f OLV CLV AOLV OLV/PM AOLV/PM CLV/PM EZOLV</p> <p>Sets Output Assembly 116. The drive writes the values from Output Assembly 116 to the MEMOBUS/Modbus address register that is stored for each parameter. The drive will not write the values from Output Assembly 116 to the registers when the MEMOBUS/Modbus address is 0.</p>	0

■ F7-33 to F7-42: Dynamic In Param 1 to 10 for CommCard

No. (Hex.)	Name	Description	Default (Range)
F7-33 - F7-42 (0375 - 037E)	Dynamic In Param 1 to 10 for CommCard	<p>V/f CL-V/f OLV CLV AOLV OLV/PM AOLV/PM CLV/PM EZOLV</p> <p>Sets Input Assembly 166. The drive sends the values from the MEMOBUS/Modbus address registers stored for each parameter to Input Assembly 166. The drive returns the default register value for the option card when the MEMOBUS/Modbus address is 0 and the value sent to Input Assembly 166 is not defined.</p>	0

■ F7-60: PZD1 Write (Control Word)

No. (Hex.)	Name	Description	Default (Range)
F7-60 (0780)	PZD1 Write (Control Word)	<p>V/f CL-V/f OLV CLV AOLV OLV/PM AOLV/PM CLV/PM EZOLV</p> <p>Sets the MEMOBUS/Modbus address for PZD1 (PPO output). PZD1 (PPO output) functions as the STW when $F7-60 = 0, 1, \text{ or } 2$.</p>	0

■ F7-61: PZD2 Write (Frequency Reference)

No. (Hex.)	Name	Description	Default (Range)
F7-61 (0781)	PZD2 Write (Frequency Reference)	<p>V/f CL-V/f OLV CLV AOLV OLV/PM AOLV/PM CLV/PM EZOLV</p> <p>Sets the MEMOBUS/Modbus address for PZD2 (PPO output). PZD2 (PPO output) functions as the HSW when $F7-61 = 0, 1, \text{ or } 2$.</p>	0

■ F7-62: PZD3 Write

No. (Hex.)	Name	Description	Default (Range)
F7-62 (0782)	PZD3 Write	<p>V/f CL-V/f OLV CLV AOLV OLV/PM AOLV/PM CLV/PM EZOLV</p> <p>Sets the MEMOBUS/Modbus address for PZD3 (PPO output). A value of 0, 1, or 2 will disable the PZD3 (PPO output) write operation to the MEMOBUS/Modbus register.</p>	0

■ F7-63: PZD4 Write

No. (Hex.)	Name	Description	Default (Range)
F7-63 (0783)	PZD4 Write	<p>V/f CL-V/f OLV CLV AOLV OLV/PM AOLV/PM CLV/PM EZOLV</p> <p>Sets the MEMOBUS/Modbus address for PZD4 (PPO output). A value of 0, 1, or 2 will disable the PZD4 (PPO output) write operation to the MEMOBUS/Modbus register.</p>	0

■ F7-64: PZD5 Write

No. (Hex.)	Name	Description	Default (Range)
F7-64 (0784)	PZD5 Write	<p>V/f CL-V/f OLV CLV AOLV OLV/PM AOLV/PM CLV/PM EZOLV</p> <p>Sets the MEMOBUS/Modbus address for PZD5 (PPO output). A value of 0, 1, or 2 will disable the PZD5 (PPO output) write operation to the MEMOBUS/Modbus register.</p>	0

■ F7-65: PZD6 Write

No. (Hex.)	Name	Description	Default (Range)
F7-65 (0785)	PZD6 Write	<div style="display: flex; justify-content: space-between; align-items: center;"> V/f CL-V/f OLV CLV AOLV OLV/PM AOLV/PM CLV/PM EZOLV </div> <p>Sets the MEMOBUS/Modbus address for PZD6 (PPO output). A value of 0, 1, or 2 will disable the PZD6 (PPO output) write operation to the MEMOBUS/Modbus register.</p>	0

■ F7-66: PZD7 Write

No. (Hex.)	Name	Description	Default (Range)
F7-66 (0786)	PZD7 Write	<div style="display: flex; justify-content: space-between; align-items: center;"> V/f CL-V/f OLV CLV AOLV OLV/PM AOLV/PM CLV/PM EZOLV </div> <p>Sets the MEMOBUS/Modbus address for PZD7 (PPO output). A value of 0, 1, or 2 will disable the PZD7 (PPO output) write operation to the MEMOBUS/Modbus register.</p>	0

■ F7-67: PZD8 Write

No. (Hex.)	Name	Description	Default (Range)
F7-67 (0787)	PZD8 Write	<div style="display: flex; justify-content: space-between; align-items: center;"> V/f CL-V/f OLV CLV AOLV OLV/PM AOLV/PM CLV/PM EZOLV </div> <p>Sets the MEMOBUS/Modbus address for PZD8 (PPO output). A value of 0, 1, or 2 will disable the PZD8 (PPO output) write operation to the MEMOBUS/Modbus register.</p>	0

■ F7-68: PZD9 Write

No. (Hex.)	Name	Description	Default (Range)
F7-68 (0788)	PZD9 Write	<div style="display: flex; justify-content: space-between; align-items: center;"> V/f CL-V/f OLV CLV AOLV OLV/PM AOLV/PM CLV/PM EZOLV </div> <p>Sets the MEMOBUS/Modbus address for PZD9 (PPO output). A value of 0, 1, or 2 will disable the PZD9 (PPO output) write operation to the MEMOBUS/Modbus register.</p>	0

■ F7-69: PZD10 Write

No. (Hex.)	Name	Description	Default (Range)
F7-69 (0789)	PZD10 Write	<div style="display: flex; justify-content: space-between; align-items: center;"> V/f CL-V/f OLV CLV AOLV OLV/PM AOLV/PM CLV/PM EZOLV </div> <p>Sets the MEMOBUS/Modbus address for PZD10 (PPO output). A value of 0, 1, or 2 will disable the PZD10 (PPO output) write operation to the MEMOBUS/Modbus register.</p>	0

■ F7-70: PZD1 Read (Status Word)

No. (Hex.)	Name	Description	Default (Range)
F7-70 (078A)	PZD1 Read (Status Word)	<div style="display: flex; justify-content: space-between; align-items: center;"> V/f CL-V/f OLV CLV AOLV OLV/PM AOLV/PM CLV/PM EZOLV </div> <p>Sets the MEMOBUS/Modbus address for PZD1 (PPO Read). PZD1 (PPO input) functions as the ZSW when $F7-70 = 0$.</p>	0

■ F7-71: PZD2 Read (Output Frequency)

No. (Hex.)	Name	Description	Default (Range)
F7-71 (078B)	PZD2 Read (Output Frequency)	<div style="display: flex; justify-content: space-between; align-items: center;"> V/f CL-V/f OLV CLV AOLV OLV/PM AOLV/PM CLV/PM EZOLV </div> <p>Sets the MEMOBUS/Modbus address for PZD2 (PPO Read). PZD2 (PPO input) functions as the HIW when $F7-71 = 0$.</p>	0

■ F7-72: PZD3 Read

No. (Hex.)	Name	Description	Default (Range)
F7-72 (078C)	PZD3 Read	<div style="display: flex; justify-content: space-between; align-items: center;"> V/f CL-V/f OLV CLV AOLV OLV/PM AOLV/PM CLV/PM EZOLV </div> <p>Sets the MEMOBUS/Modbus address for PZD3 (PPO Read). A value of 0 will disable the PZD3 (PPO Read) load operation from the MEMOBUS/Modbus register.</p>	0

■ F7-73: PZD4 Read

No. (Hex.)	Name	Description	Default (Range)
F7-73 (078D)	PZD4 Read	<p>V/f CL-V/f OLV CLV AOLV OLV/PM AOLV/PM CLV/PM EZOLV</p> <p>Sets the MEMOBUS/Modbus address for PZD4 (PPO Read). A value of 0 will disable the PZD4 (PPO Read) load operation from the MEMOBUS/Modbus register.</p>	0

■ F7-74: PZD5 Read

No. (Hex.)	Name	Description	Default (Range)
F7-74 (078E)	PZD5 Read	<p>V/f CL-V/f OLV CLV AOLV OLV/PM AOLV/PM CLV/PM EZOLV</p> <p>Sets the MEMOBUS/Modbus address for PZD5 (PPO Read). A value of 0 will disable the PZD5 (PPO Read) load operation from the MEMOBUS/Modbus register.</p>	0

■ F7-75: PZD6 Read

No. (Hex.)	Name	Description	Default (Range)
F7-75 (078F)	PZD6 Read	<p>V/f CL-V/f OLV CLV AOLV OLV/PM AOLV/PM CLV/PM EZOLV</p> <p>Sets the MEMOBUS/Modbus address for PZD6 (PPO Read). A value of 0 will disable the PZD6 (PPO Read) load operation from the MEMOBUS/Modbus register.</p>	0

■ F7-76: PZD7 Read

No. (Hex.)	Name	Description	Default (Range)
F7-76 (0790)	PZD7 Read	<p>V/f CL-V/f OLV CLV AOLV OLV/PM AOLV/PM CLV/PM EZOLV</p> <p>Sets the MEMOBUS/Modbus address for PZD7 (PPO Read). A value of 0 will disable the PZD7 (PPO input) load operation from the MEMOBUS/Modbus register.</p>	0

■ F7-77: PZD8 Read

No. (Hex.)	Name	Description	Default (Range)
F7-77 (0791)	PZD8 Read	<p>V/f CL-V/f OLV CLV AOLV OLV/PM AOLV/PM CLV/PM EZOLV</p> <p>Sets the MEMOBUS/Modbus address for PZD8 (PPO Read). A value of 0 will disable the PZD8 (PPO Read) load operation from the MEMOBUS/Modbus register.</p>	0

■ F7-78: PZD9 Read

No. (Hex.)	Name	Description	Default (Range)
F7-78 (0792)	PZD9 Read	<p>V/f CL-V/f OLV CLV AOLV OLV/PM AOLV/PM CLV/PM EZOLV</p> <p>Sets the MEMOBUS/Modbus address for PZD9 (PPO Read). A value of 0 will disable the PZD9 (PPO Read) load operation from the MEMOBUS/Modbus register.</p>	0

■ F7-79: PZD10 Read

No. (Hex.)	Name	Description	Default (Range)
F7-79 (0793)	PZD10 Read	<p>V/f CL-V/f OLV CLV AOLV OLV/PM AOLV/PM CLV/PM EZOLV</p> <p>Sets the MEMOBUS/Modbus address for PZD10 (PPO Read). A value of 0 will disable the PZD10 (PPO Read) load operation from the MEMOBUS/Modbus register.</p>	0

12.8 H: Terminal Functions

H parameters are used to assign functions to external input and output terminals.

◆ H1: Digital Inputs

H1 Parameters set the MFDI terminal functions.

■ H1-01 to H1-08 Terminal S1 to S8 Function Selection

The drive has 8 MFDI terminals. Refer to [Table 12.54](#) for drive default settings and functions.

Table 12.54 MFDI Default Settings and Functions

No.	Name	Default	Function
H1-01	Terminal S1 Function Selection	40 (F) <i>*1</i>	Forward RUN (2-Wire)
H1-02	Terminal S2 Function Selection	41 (F) <i>*1</i>	Reverse RUN (2-Wire)
H1-03	Terminal S3 Function Selection	24	External Fault (NO-Always-Coast)
H1-04	Terminal S4 Function Selection	14	Fault Reset
H1-05	Terminal S5 Function Selection	3 (0) <i>*1</i>	Multi-Step Speed Reference 1
H1-06	Terminal S6 Function Selection	4 (3) <i>*1</i>	Multi-Step Speed Reference 2
H1-07	Terminal S7 Function Selection	6 (4) <i>*1</i>	Jog Reference Selection
H1-08	Terminal S8 Function Selection	8	Baseblock Command (N.O.)

*1 The value in parentheses identifies the default setting when you set $A1-03 = 3330$ [Initialize Parameters = 3-Wire Initialization].

Refer to [Table 12.55](#) the and use *H1-xx* [MFDI Function Select] to set the function.

Table 12.55 MFDI Setting Values

Setting Value	Function	Reference	Setting Value	Function	Reference
0 <i>*1</i>	3-Wire Sequence	826	15 <i>*1</i>	Fast Stop (N.O.)	833
1	LOCAL/REMOTE Selection	827	16	Motor 2 Selection	833
2	External Reference 1/2 Selection	827	17 <i>*1</i>	Fast Stop (N.C.)	834
3	Multi-Step Speed Reference 1	827	18	Timer Function	834
4	Multi-Step Speed Reference 2	828	19	PID Disable	835
5	Multi-Step Speed Reference 3	828	1A	Accel/Decel Time Selection 2	835
6	Jog Reference Selection	828	1B	Programming Lockout	835
7	Accel/Decel Time Selection 1	828	1E	Reference Sample Hold	835
8 <i>*1</i>	Baseblock Command (N.O.)	828	20 to 2F <i>*1</i>	External Fault	836
9 <i>*1</i>	Baseblock Command (N.C.)	829	30	PID Integrator Reset	836
A	Accel/Decel Ramp Hold	829	31	PID Integrator Hold	837
B	Overheat Alarm (oH2)	829	32	Multi-Step Speed Reference 4	837
C	Analog Terminal Enable Selection	829	34	PID Soft Starter Disable	837
D	Ignore Speed Fdbk (V/f w/o Enc)	829	35	PID Input (Error) Invert	837
E	ASR Integral Reset	829	3E	PID Setpoint Selection 1	837
F	Not Used	830	3F	PID Setpoint Selection 2	837
10	Up Command	830	40 <i>*1</i>	Forward RUN (2-Wire)	838
11	Down Command	831	41 <i>*1</i>	Reverse RUN (2-Wire)	838
12 <i>*1</i>	Forward Jog	832	42 <i>*1</i>	Run Command (2-Wire Sequence 2)	838
13 <i>*1</i>	Reverse Jog	832	43 <i>*1</i>	FWD/REV (2-Wire Sequence 2)	839
14	Fault Reset Procedure	833	44	Add Offset Frequency 1 (d7-01)	839

Setting Value	Function	Reference
45	Add Offset Frequency 2 (d7-02)	839
46	Add Offset Frequency 3 (d7-03)	839
47	Node Setup (CANopen)	839
60	DC Injection Braking Command	839
61	Speed Search from Fmax	840
62	Speed Search from Fref	840
63	Field Weakening	840
65 */	KEB Ride-Thru 1 Activate (N.C.)	840
66 */	KEB Ride-Thru 1 Activate (N.O.)	841
67	Communications Test Mode	841
68	High Slip Braking (HSB) Activate	841
6A	Drive Enable	841
71	Torque Control	841
72	Zero Servo	842

Setting Value	Function	Reference
75	Up 2 Command	842
76	Down 2 Command	843
77	ASR Gain (C5-03) Select	844
78	Analog TorqueRef Polarity Invert	844
7A */	KEB Ride-Thru 2 Activate (N.C.)	844
7B */	KEB Ride-Thru 2 Activate (N.O.)	844
7C */	Short Circuit Braking (N.O.)	845
7D */	Short Circuit Braking (N.C.)	845
7E	Reverse Rotation Identifier	845
90 to 97 */	DWEZ Digital Inputs 1 to 8	845
9F	DWEZ Disable	845
101 to 19F	Inverse Inputs of 1 to 9F Sets the function of the selected MFDI to operate inversely. To select the function for inverse input, enter two digits 01 to 9F for the "xx" in "1xx".	846

*1 Inverse input is not available.

■ H1-01: Terminal S1 Function Selection

No. (Hex.)	Name	Description	Default (Range)
H1-01 (0438)	Terminal S1 Function Selection	<input type="checkbox"/> V/f <input type="checkbox"/> CL-V/f <input type="checkbox"/> OLV <input type="checkbox"/> CLV <input type="checkbox"/> AOLV <input type="checkbox"/> OLV/PM <input type="checkbox"/> AOLV/PM <input type="checkbox"/> CLV/PM <input type="checkbox"/> EZOLV Sets the function for MFDI terminal S1.	40 (1 - 1FF)

Note:

The default setting is *F* when the drive is initialized for *3-Wire Initialization* [A1-03 = 3330].

■ H1-02: Terminal S2 Function Selection

No. (Hex.)	Name	Description	Default (Range)
H1-02 (0439)	Terminal S2 Function Selection	<input type="checkbox"/> V/f <input type="checkbox"/> CL-V/f <input type="checkbox"/> OLV <input type="checkbox"/> CLV <input type="checkbox"/> AOLV <input type="checkbox"/> OLV/PM <input type="checkbox"/> AOLV/PM <input type="checkbox"/> CLV/PM <input type="checkbox"/> EZOLV Sets the function for MFDI terminal S2.	41 (1 - 1FF)

Note:

The default setting is *F* when the drive is initialized for *3-Wire Initialization* [A1-03 = 3330].

■ H1-03: Terminal S3 Function Selection

No. (Hex.)	Name	Description	Default (Range)
H1-03 (0400)	Terminal S3 Function Selection	<input type="checkbox"/> V/f <input type="checkbox"/> CL-V/f <input type="checkbox"/> OLV <input type="checkbox"/> CLV <input type="checkbox"/> AOLV <input type="checkbox"/> OLV/PM <input type="checkbox"/> AOLV/PM <input type="checkbox"/> CLV/PM <input type="checkbox"/> EZOLV Sets the function for MFDI terminal S3.	24 (0 - 1FF)

■ H1-04: Terminal S4 Function Selection

No. (Hex.)	Name	Description	Default (Range)
H1-04 (0401)	Terminal S4 Function Selection	<input type="checkbox"/> V/f <input type="checkbox"/> CL-V/f <input type="checkbox"/> OLV <input type="checkbox"/> CLV <input type="checkbox"/> AOLV <input type="checkbox"/> OLV/PM <input type="checkbox"/> AOLV/PM <input type="checkbox"/> CLV/PM <input type="checkbox"/> EZOLV Sets the function for MFDI terminal S4.	14 (0 - 1FF)

■ H1-05: Terminal S5 Function Selection

No. (Hex.)	Name	Description	Default (Range)
H1-05 (0402)	Terminal S5 Function Selection	<input type="checkbox"/> V/f <input type="checkbox"/> CL-V/f <input type="checkbox"/> OLV <input type="checkbox"/> CLV <input type="checkbox"/> AOLV <input type="checkbox"/> OLV/PM <input type="checkbox"/> AOLV/PM <input type="checkbox"/> CLV/PM <input type="checkbox"/> EZOLV Sets the function for MFDI terminal S5.	3 (0 - 1FF)

Note:

When you initialize the drive for *3-Wire Initialization* [*A1-03 = 3330*], the default setting is *0*.

■ **H1-06: Terminal S6 Function Selection**

No. (Hex.)	Name	Description	Default (Range)
H1-06 (0403)	Terminal S6 Function Selection	V/f CL-V/f OLV CLV AOLV OLV/PM AOLV/PM CLV/PM EZOLV Sets the function for MFDI terminal S6.	4 (0 - 1FF)

Note:

When you initialize the drive for *3-Wire Initialization* [*A1-03 = 3330*], the default setting is *3*.

■ **H1-07: Terminal S7 Function Selection**

No. (Hex.)	Name	Description	Default (Range)
H1-07 (0404)	Terminal S7 Function Selection	V/f CL-V/f OLV CLV AOLV OLV/PM AOLV/PM CLV/PM EZOLV Sets the function for MFDI terminal S7.	6 (0 - 1FF)

Note:

When you initialize the drive for *3-Wire Initialization* [*A1-03 = 3330*], the default setting is *4*.

■ **H1-08: Terminal S8 Function Selection**

No. (Hex.)	Name	Description	Default (Range)
H1-08 (0405)	Terminal S8 Function Selection	V/f CL-V/f OLV CLV AOLV OLV/PM AOLV/PM CLV/PM EZOLV Sets the function for MFDI terminal S8.	8 (0 - 1FF)

■ **H1-21: Terminal S1 Function Select 2**

No. (Hex.)	Name	Description	Default (Range)
H1-21 (0B70)	Terminal S1 Function Selection 2	V/f CL-V/f OLV CLV AOLV OLV/PM AOLV/PM CLV/PM EZOLV Sets the second function for MFDI terminal S1.	F (1 - 19F)

When MFDI terminal S1 activates, it will operate the function set to *H1-01* [*Terminal S1 Function Selection*] and the function set to *H1-21* at the same time.

When the setting value is *F*, the function is disabled.

■ **H1-22: Terminal S2 Function Select 2**

No. (Hex.)	Name	Description	Default (Range)
H1-22 (0B71)	Terminal S2 Function Select 2	V/f CL-V/f OLV CLV AOLV OLV/PM AOLV/PM CLV/PM EZOLV Sets the second function for MFDI terminal S2.	F (1 - 19F)

When MFDI terminal S2 activates, it will operate the function set to *H1-02* [*Terminal S2 Function Selection*] and the function set to *H1-22* at the same time.

When the setting value is *F*, the function is disabled.

■ **H1-23: Terminal S3 Function Select 2**

No. (Hex.)	Name	Description	Default (Range)
H1-23 (0B72)	Terminal S3 Function Selection 2	V/f CL-V/f OLV CLV AOLV OLV/PM AOLV/PM CLV/PM EZOLV Sets the second function for MFDI terminal S3.	F (1 - 19F)

When MFDI terminal S3 activates, it will operate the function set to *H1-03* [*Terminal S3 Function Selection*] and the function set to *H1-23* at the same time.

When the setting value is *F*, the function is disabled.

■ H1-24: Terminal S4 Function Selection 2

No. (Hex.)	Name	Description	Default (Range)
H1-24 (0B73)	Terminal S4 Function Selection 2	<div style="display: flex; justify-content: space-between; gap: 5px;"> V/f CL-V/f OLV CLV AOLV OLV/PM AOLV/PM CLV/PM EZOLV </div> Sets the second function for MFDI terminal S4.	F (1 - 19F)

When MFDI terminal S4 activates, it will operate the function set to *H1-04 [Terminal S4 Function Selection]* and the function set to *H1-24* at the same time.

When the setting value is F, the function is disabled.

■ H1-25: Terminal S5 Function Select 2

No. (Hex.)	Name	Description	Default (Range)
H1-25 (0B74)	Terminal S5 Function Selection 2	<div style="display: flex; justify-content: space-between; gap: 5px;"> V/f CL-V/f OLV CLV AOLV OLV/PM AOLV/PM CLV/PM EZOLV </div> Sets the second function for MFDI terminal S5.	F (1 - 19F)

When MFDI terminal S5 activates, it will operate the function set to *H1-05 [Terminal S5 Function Selection]* and the function set to *H1-25* at the same time.

When the setting value is F, the function is disabled.

■ H1-26: Terminal S6 Function Select 2

No. (Hex.)	Name	Description	Default (Range)
H1-26 (0B75)	Terminal S6 Function Selection 2	<div style="display: flex; justify-content: space-between; gap: 5px;"> V/f CL-V/f OLV CLV AOLV OLV/PM AOLV/PM CLV/PM EZOLV </div> Sets the second function for MFDI terminal S6.	F (1 - 19F)

When MFDI terminal S6 activates, it will operate the function set to *H1-06 [Terminal S6 Function Selection]* and the function set to *H1-26* at the same time.

When the setting value is F, the function is disabled.

■ H1-27: Terminal S7 Function Select 2

No. (Hex.)	Name	Description	Default (Range)
H1-27 (0B76)	Terminal S7 Function Selection 2	<div style="display: flex; justify-content: space-between; gap: 5px;"> V/f CL-V/f OLV CLV AOLV OLV/PM AOLV/PM CLV/PM EZOLV </div> Sets the second function for MFDI terminal S7.	F (1 - 19F)

When MFDI terminal S7 activates, it will operate the function set to *H1-07 [Terminal S7 Function Selection]* and the function set to *H1-27* at the same time.

When the setting value is F, the function is disabled.

■ H1-28: Terminal S8 Function Select 2

No. (Hex.)	Name	Description	Default (Range)
H1-28 (0B77)	Terminal S8 Function Selection 2	<div style="display: flex; justify-content: space-between; gap: 5px;"> V/f CL-V/f OLV CLV AOLV OLV/PM AOLV/PM CLV/PM EZOLV </div> Sets the second function for MFDI terminal S8.	F (1 - 19F)

When MFDI terminal S8 activates, it will operate the function set to *H1-08 [Terminal S8 Function Selection]* and the function set to *H1-28* at the same time.

When the setting value is F, the function is disabled.

■ MEMOBUS/Modbus MFDI 1 to 3 Function Selection

You can set the function for the MFDI to MEMOBUS register *bit 0 to 2 of [15C0(Hex.)]*. Use *H1-40 to H1-42 [Extend MFDI Function Selection]* to select the function.

Note:

- Refer to H1-xx “MFDI setting values” for the setting values of the MFDI.
- You cannot set 0 [3-Wire Sequence] or 20 to 2F [External fault] in H1-40 to H1-42.
- When you will not use H1-40 to H1-42, set them to F [Through Mode].
- You cannot use MFDI for digital input option D1-A3 at the same time as function selection for MEMOBUS/Modbus MFDI 1 to 3.

■ **H1-40: Mbus Reg 15C0h bit0 Input Func**

No. (Hex.)	Name	Description	Default (Range)
H1-40 (0B54)	Mbus Reg 15C0h bit0 Input Func	<div style="display: flex; justify-content: space-between; gap: 5px;"> V/f CL-V/f OLV CLV AOLV OLV/PM AOLV/PM CLV/PM EZOLV </div> Selects MFDI function assigned to bit 0 of the MEMOBUS register 15C0 (Hex.).	F (1 - 19F)

■ **H1-41: Mbus Reg 15C0h bit1 Input Func**

No. (Hex.)	Name	Description	Default (Range)
H1-41 (0B55)	Mbus Reg 15C0h bit1 Input Func	<div style="display: flex; justify-content: space-between; gap: 5px;"> V/f CL-V/f OLV CLV AOLV OLV/PM AOLV/PM CLV/PM EZOLV </div> Selects MFDI function assigned to bit 1 of the MEMOBUS register 15C0 (Hex.).	F (1 - 19F)

■ **H1-42: Mbus Reg 15C0h bit2 Input Func**

No. (Hex.)	Name	Description	Default (Range)
H1-42 (0B56)	Mbus Reg 15C0h bit2 Input Func	<div style="display: flex; justify-content: space-between; gap: 5px;"> V/f CL-V/f OLV CLV AOLV OLV/PM AOLV/PM CLV/PM EZOLV </div> Selects MFDI function assigned to bit 2 of the MEMOBUS register 15C0 (Hex.).	F (1 - 19F)

◆ **Multi-Function Digital Input Setting Values**

Selects a function set with H1-01 to H1-08.

■ **0: 3-Wire Sequence**

Setting Value	Function	Description
0	3-Wire Sequence	<div style="display: flex; justify-content: space-between; gap: 5px;"> V/f CL-V/f OLV CLV AOLV OLV/PM AOLV/PM CLV/PM EZOLV </div> Sets the direction of motor rotation for 3-wire sequence.

If the 3-wire sequence is set to a terminal that is not MFDI terminals S1 and S2, these terminals will be the input terminals for Forward run/Reverse run command. The drive will automatically set terminal S1 to Run command (RUN) and terminal S2 to Stop command (STOP).

When terminal S1 (Run command) activates for 1 ms minimum, the drive rotates the motor. When terminal S2 (Stop command) deactivates, the drive stops. When terminal Sx that is set in 3-wire sequence deactivates, the drive operates in the forward direction, and when it activates, the drive operates in the reverse direction.

WARNING! Sudden Movement Hazard. Set the MFDI parameters before you close control circuit switches. Incorrect Run/Stop circuit sequence settings can cause serious injury or death from moving equipment.

WARNING! Sudden Movement Hazard. When you use a 3-Wire sequence, set A1-03 = 3330 [Initialize Parameters = 3-Wire Initialization] and make sure that b1-17 = 0 [Run Command at Power Up = Disregard Existing RUN Command] (default). If you do not correctly set the drive parameters for 3-Wire operation before you energize the drive, the motor can suddenly rotate when you energize the drive.

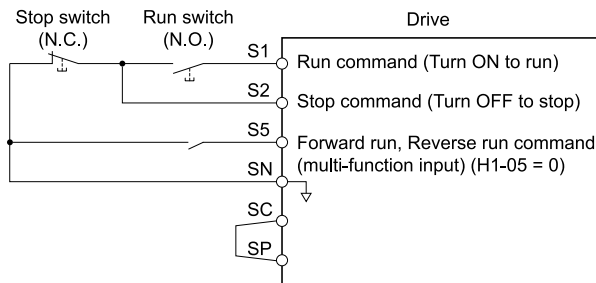

Figure 12.77 3-Wire Sequence Wiring Example

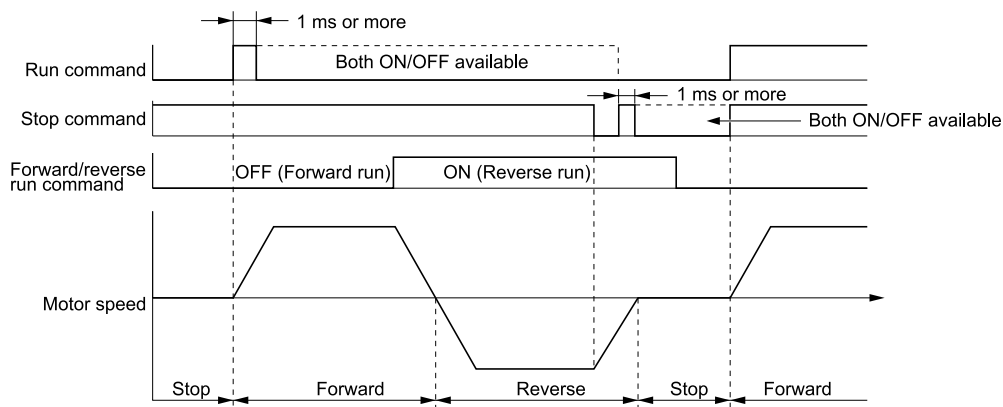

Figure 12.78 3-Wire Sequence Time Chart

Note:

- To input the Run command, activate the terminal for 1 ms minimum.
- The default setting for *b1-17 [Run Command at Power Up]* is 0 [Disregard existing RUN command]. If you enable the Run command when the drive is energized, the protective function activates and the **RUN** flashes quickly. When the application allows Run, set *b1-17 = 1 [Accept Existing RUN Command]*.

1: LOCAL/REMOTE Selection

Setting Value	Function	Description
1	LOCAL/REMOTE Selection	V/f CL-V/f OLV CLV AOLV OLV/PM AOLV/PM CLV/PM EZOLV Sets drive control for the keypad (LOCAL) or an external source (REMOTE).

Note:

- When the MFDI terminal sets the LOCAL/REMOTE selection, **LO/RE** on the keypad is disabled.
- When LOCAL Mode is selected, the green light for **LO/RE** comes on.
- When the Run command is ON, you cannot switch between LOCAL Mode and REMOTE Mode.

ON : LOCAL

The keypad is the Frequency reference source and Run command source.

OFF : REMOTE

The frequency reference and Run command settings are set in *b1-01, b1-02 [Frequency Reference Selection 1/2]* or *b1-15, b1-16 [Run Command Selection 1/2]*.

2: External Reference 1/2 Selection

Setting Value	Function	Description
2	External Reference 1/2 Selection	V/f CL-V/f OLV CLV AOLV OLV/PM AOLV/PM CLV/PM EZOLV Sets the drive to use Run command source 1/2 or Reference command source 1/2 when in REMOTE Mode.

Note:

When the drive is receiving a Run command, you cannot switch between reference sources.

ON : *b1-15 = [Frequency Reference Selection 2], b1-16 [Run Command Selection 2]*

OFF : *b1-01 = [Frequency Reference Selection 1], b1-02 [Run Command Selection 1]*

3: Multi-Step Speed Reference 1

Setting Value	Function	Description
3	Multi-Step Speed Reference 1	V/f CL-V/f OLV CLV AOLV OLV/PM AOLV/PM CLV/PM EZOLV Uses speed references <i>d1-01 to d1-16</i> to set a multi-step speed reference.

Note:

Refer to “Setting Procedures for Multi-step Speed Operation” in “d: Reference Settings” for more information.

■ **4: Multi-Step Speed Reference 2**

Setting Value	Function	Description
4	Multi-Step Speed Reference 2	<div style="display: flex; justify-content: space-between; align-items: center;"> V/f CL-V/f OLV CLV AOLV OLV/IPM AOLV/IPM CLV/IPM EZOLV </div> <p>Uses speed references <i>d1-01</i> to <i>d1-16</i> to set a multi-step speed reference.</p>

Note:

Refer to “Setting Procedures for Multi-step Speed Operation” in “d: Reference Settings” for more information.

■ **5: Multi-Step Speed Reference 3**

Setting Value	Function	Description
5	Multi-Step Speed Reference 3	<div style="display: flex; justify-content: space-between; align-items: center;"> V/f CL-V/f OLV CLV AOLV OLV/IPM AOLV/IPM CLV/IPM EZOLV </div> <p>Uses speed references <i>d1-01</i> to <i>d1-16</i> to set a multi-step speed reference.</p>

Note:

Refer to “Setting Procedures for Multi-step Speed Operation” in “d: Reference Settings” for more information.

■ **6: Jog Reference Selection**

Setting Value	Function	Description
6	Jog Reference Selection	<div style="display: flex; justify-content: space-between; align-items: center;"> V/f CL-V/f OLV CLV AOLV OLV/IPM AOLV/IPM CLV/IPM EZOLV </div> <p>Sets the drive to use the JOG Frequency Reference (JOG command) set in <i>d1-17</i>. The JOG Frequency Reference (JOG command) overrides Frequency References 1 to 16 (<i>d1-01</i> to <i>d1-16</i>).</p>

■ **7: Accel/Decel Time Selection 1**

Setting Value	Function	Description
7	Accel/Decel Time Selection 1	<div style="display: flex; justify-content: space-between; align-items: center;"> V/f CL-V/f OLV CLV AOLV OLV/IPM AOLV/IPM CLV/IPM EZOLV </div> <p>Sets the drive to use <i>Acceleration/Deceleration Time 1</i> [<i>C1-01</i>, <i>C1-02</i>] or <i>Acceleration/Deceleration Time 2</i> [<i>C1-03</i>, <i>C1-04</i>].</p>

Note:

Refer to “C1: Accel & Decel Time” for more information.

■ **8: Baseblock Command (N.O.)**

Setting Value	Function	Description
8	Baseblock Command (N.O.)	<div style="display: flex; justify-content: space-between; align-items: center;"> V/f CL-V/f OLV CLV AOLV OLV/IPM AOLV/IPM CLV/IPM EZOLV </div> <p>Sets the command that stops drive output and coasts the motor to stop when the input is ON.</p>

The keypad flashes *bb* [Baseblock]. If you cancel the baseblock command when the Run command is active, the drive will restart the motor and use the speed search function.

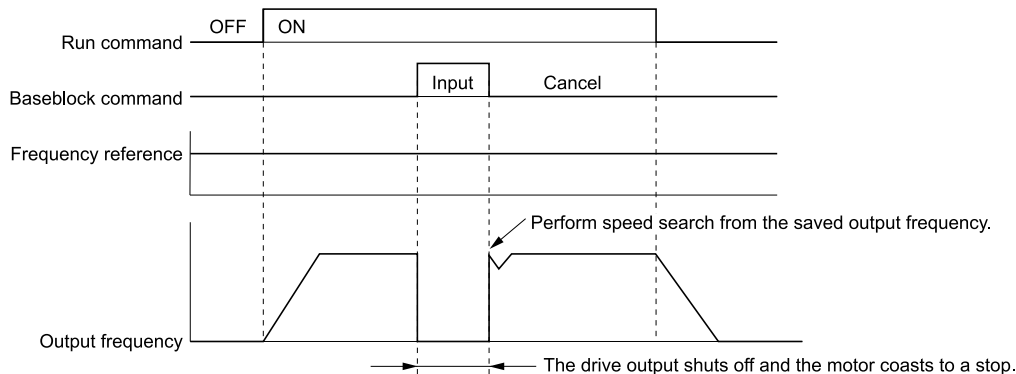

Figure 12.79 Baseblock Command Time Chart

ON : Baseblock (drive output stop)

OFF : Normal operation

■ 9: Baseblock Command (N.C.)

Setting Value	Function	Description
9	Baseblock Command (N.C.)	<div style="display: flex; justify-content: space-between; align-items: center;"> V/f CL-V/f OLV CLV AOLV OLV/PM AOLV/PM CLV/PM EZOLV </div> <p>Sets the command that stops drive output and coasts the motor to stop when the input terminal is OFF.</p>

The keypad flashes *bb* [Baseblock]. If you cancel the baseblock command when the Run command is active, the drive will restart the motor and use the speed search function.

ON : Normal operation

OFF : Baseblock (drive output stop)

■ A: Accel/Decel Ramp Hold

Setting Value	Function	Description
A	Accel/Decel Ramp Hold	<div style="display: flex; justify-content: space-between; align-items: center;"> V/f CL-V/f OLV CLV AOLV OLV/PM AOLV/PM CLV/PM EZOLV </div> <p>Momentarily pauses motor acceleration and deceleration when the terminal is turned ON, retains the output frequency that was stored in the drive at the time of the pause, and restarts motor operation.</p>

If the terminal is deactivated, the drive restarts acceleration and deceleration.

When the acceleration/deceleration ramp hold terminal is activated and $d4-01 = 1$ [*Freq Reference Retention Select = Enabled*], the drive will store the output frequency in memory. While the acceleration/deceleration ramp hold command is activated, the drive will always restart the motor at this output frequency.

Note:

Refer to “d4-01: Freq Reference Retention Select” for more information.

■ B: Overheat Alarm (oH2)

Setting Value	Function	Description
B	Overheat Alarm (oH2)	<div style="display: flex; justify-content: space-between; align-items: center;"> V/f CL-V/f OLV CLV AOLV OLV/PM AOLV/PM CLV/PM EZOLV </div> <p>Sets the drive to display an <i>oH2</i> [Drive Overheat Warning] alarm when the input terminal is ON. The alarm does not have an effect on drive operation.</p>

■ C: Analog Terminal Enable Selection

Setting Value	Function	Description
C	Analog Terminal Enable Selection	<div style="display: flex; justify-content: space-between; align-items: center;"> V/f CL-V/f OLV CLV AOLV OLV/PM AOLV/PM CLV/PM EZOLV </div> <p>Sets the command that enables or disables the terminals selected in <i>H3-14</i> [Analog Input Terminal Enable Sel].</p>

ON : Terminal selected with *H3-14* is enabled

OFF : Terminal selected with *H3-14* is disabled

■ D: Ignore Speed Fdbk (V/f w/o Enc)

Setting Value	Function	Description
D	Ignore Speed Fdbk (V/f w/o Enc)	<div style="display: flex; justify-content: space-between; align-items: center;"> V/f CL-V/f OLV CLV AOLV OLV/PM AOLV/PM CLV/PM EZOLV </div> <p>Sets the command to disable speed feedback control and run the drive in V/f control or use speed feedback from the encoder.</p>

ON : Speed feedback control disable (V/f Control)

OFF : Speed feedback control enable (Closed Loop V/f Control)

■ E: ASR Integral Reset

Setting Value	Function	Description
E	ASR Integral Reset	<div style="display: flex; justify-content: space-between; align-items: center;"> V/f CL-V/f OLV CLV AOLV OLV/PM AOLV/PM CLV/PM EZOLV </div> <p>Sets the command to reset the integral value and use PI control or P control for the speed control loop.</p>

ON : P control

OFF : PI control

■ **F: Not Used**

Setting Value	Function	Description
F	Not Used	<div style="display: flex; justify-content: space-between; align-items: center;"> V/f CL-V/f OLV CLV AOLV OLV/PM AOLV/PM CLV/PM EZOLV </div> Use this setting for unused terminals or to use terminals in through mode.

Through Mode uses the signal input to the terminal as a digital input for the upper sequence through a communication option or MEMOBUS/Modbus communications. This input signal does not have an effect on drive operation.

■ **10: Up Command**

Setting Value	Function	Description
10	Up Command	<div style="display: flex; justify-content: space-between; align-items: center;"> V/f CL-V/f OLV CLV AOLV OLV/PM AOLV/PM CLV/PM EZOLV </div> Sets the command to use a push button switch to increase the drive frequency reference. You must also set <i>Setting 11 [Down Command]</i> .

ON : Increases the frequency reference.

OFF : Holds the current frequency reference.

Note:

- If you set only the Up command or only the Down command, the drive will detect *oPE03 [Multi-Function Input Setting Err]*.
- If you set two or more of these functions at the same time, the drive will detect *oPE03*:
 - Up/Down command
 - Accel/Decel Ramp Hold
 - Reference Sample Hold
 - Offset Frequency 1, 2, 3 addition
 - Up/Down 2 Command
- The Up/Down command does not function in these conditions:
 - b1-01 = 2, 3 [Frequency Reference Selection 1 = Memobus/Modbus Communications, Option PCB]*
 - b1-02 ≠ 1 [Run Command Selection 1 ≠ Control Circuit Terminal]*
 - Drive is in LOCAL mode
 - Set to *b1-15 [Frequency Reference Selection 2]* by use of *H1-xx = 2 [MFDI Function Select = External Reference 1/2 Selection]*

When you enter the UP command, the frequency reference increases. When you enter the Down command, the frequency reference decreases.

The Up and Down commands have priority over all other frequency references. When you enable the Up/Down command, the drive will ignore these frequency references:

- Frequency reference from Keypad [*b1-01 = 0*]
- Frequency reference from Analog Input [*b1-01 = 1*]
- Frequency reference from Pulse Train Input [*b1-01 = 4*]

Table 12.56 shows the Up and Down commands with their operation.

Table 12.56 Up Command and Down Command

Command status		Drive operation
Up command (10)	Down command (11)	
OFF	OFF	Keeps the current frequency reference.
ON	OFF	Increases the frequency reference.
OFF	ON	Decreases the frequency reference.
ON	ON	Keeps the current frequency reference.

Combine Frequency Reference Hold Functions and Up/Down Commands

- When you clear the Run command or when *d4-01 = 0 [Freq Reference Hold Selection = Disabled]*, and you restart the drive, the Up/Down command resets to 0.
- When *d4-01 = 1 [Enabled]*, the drive saves the frequency reference set during the Up/Down command. When you cycle the Run command or restart the drive, the drive saves the frequency reference value and restarts the motor at this frequency value. After you clear the Run command, activate the terminal set for the Up command or Down command to set the saved reference value to 0.

Note:

Refer to “d4-01 [Freq Reference Hold Selection]” for more information.

Combine Upper/Lower Limits of the Frequency Reference and the Up/Down Commands

Set the upper limit value of the frequency reference to *d2-01* [Frequency Reference Upper Limit].

Use an analog input or *d2-02* [Frequency Reference Lower Limit] to set the lower limit value of the frequency reference. The configurable values change when the setting for *d4-10* [Up/Down Freq Lower Limit Select] changes. When you input a Run command, these are the lower limits of the frequency reference:

- When the lower limit of the frequency reference is set only for *d2-02*, the drive accelerates the motor to the lower limit value of the frequency reference when you input the Run command.
- When the lower limit of the frequency reference is set only for analog input, the drive accelerates the motor to the lower limit value of the frequency reference when the Run command, and Up command or Down command for the drive is enabled. When only the Run command is enabled, the motor does not start.
- When these conditions occur, the drive accelerates the motor to the *d2-02* setting value when the Run command is input. When the motor accelerates to the setting value of *d2-02*, the motor accelerates to the lower limit value of the analog input when you enable the Up/Down command.
 - The lower limit value of the frequency reference is set for the analog input and *d2-02*
 - The lower limit value of the analog input is higher than the setting value of *d2-02*

Note:

Refer to “d4-10: Up/Down Freq Lower Limit Select” for details.

Figure 12.80 shows an example of how Up/Down command operates. In this example, the lower limit value of the frequency reference is set in *d2-02*. Figure 12.80 shows the time chart when Freq Reference Retention Select [*d4-01*] is enabled and disabled.

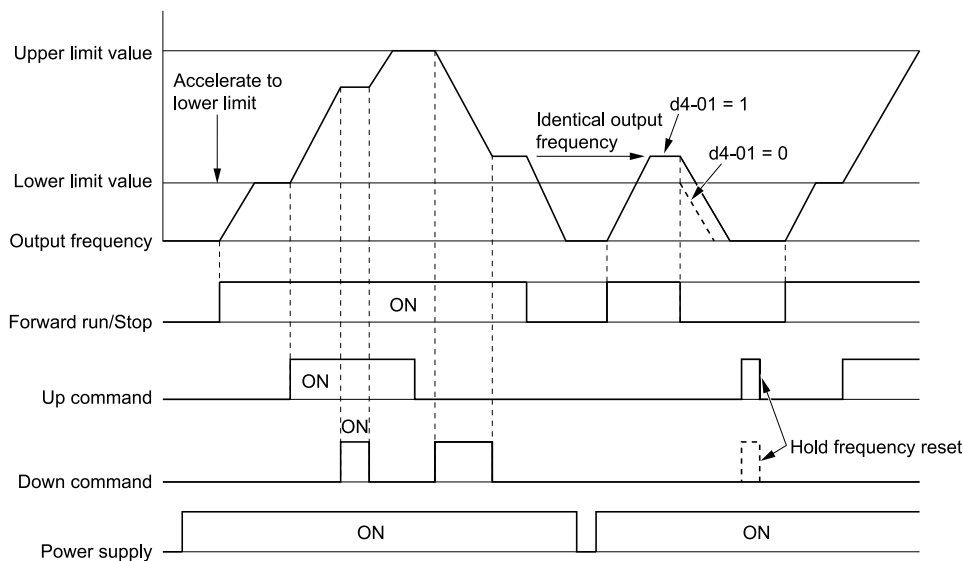

Figure 12.80 Up/Down Command Time Chart

■ 11: Down Command

Setting Value	Function	Description
11	Down Command	<div style="display: flex; gap: 5px;"> V/f CL-V/f OLV CLV AOLV OLV/PM AOLV/PM CLV/PM EZOLV </div> <p>Sets the command to use a push button switch to decrease the drive frequency reference. You must also set <i>Setting 10</i> [Up Command].</p>

ON : Decreases the frequency reference.

OFF : Holds the current frequency reference.

Note:

- If you set only the Up command or only the Down command, the drive will detect *oPE03 [Multi-Function Input Setting Err]*.
- If you set two or more of these functions at the same time, the drive will detect *oPE03*:
 - Up/Down command
 - Accel/Decel Ramp Hold
 - Reference Sample Hold
 - Offset Frequency 1, 2, 3 addition
 - Up/Down 2 Command
- The Up/Down command does not function in these conditions:
 - b1-01 = 2, 3 [Frequency Reference Selection 1 = Memobus/Modbus Communications, Option PCB]*
 - b1-02 ≠ 1 [Run Command Selection 1 ≠ Control Circuit Terminal]*
 - Drive is in LOCAL mode
 - Set to *b1-15 [Frequency Reference Selection 2]* by use of *H1-xx = 2 [MFDI Function Select = External Reference 1/2 Selection]*

When you enter the UP command, the frequency reference increases. When you enter the Down command, the frequency reference decreases.

The Up and Down commands have priority over all other frequency references. When you enable the Up/Down command, the drive will ignore these frequency references:

- Frequency reference from Keypad [*b1-01 = 0*]
- Frequency reference from Analog Input [*b1-01 = 1*]
- Frequency reference from Pulse Train Input [*b1-01 = 4*]

■ **12: Forward Jog**

Setting Value	Function	Description
12	Forward Jog	<div style="display: flex; justify-content: space-between; align-items: center;"> V/f CL-V/f OLV CLV AOLV OLV/PM AOLV/PM CLV/PM EZOLV </div> Sets the command to operate the motor in the forward direction at the Jog Frequency set in <i>d1-17 [Jog Reference]</i> .

Note:

- It is not necessary to input the Run command.
- The Forward JOG command has priority over all other frequency references.
- When the Forward JOG and Reverse JOG commands are activated at the same time for 500 ms or longer, the drive will ramp to stop.

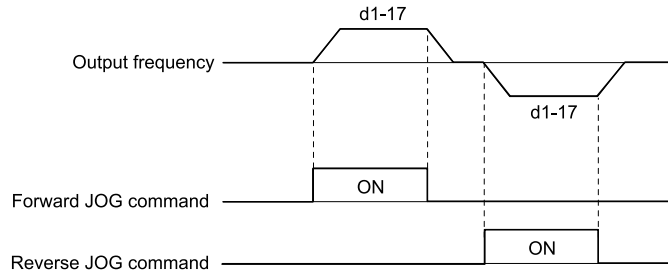

Figure 12.81 JOG Operation Pattern

■ **13: Reverse Jog**

Setting Value	Function	Description
13	Reverse Jog	<div style="display: flex; justify-content: space-between; align-items: center;"> V/f CL-V/f OLV CLV AOLV OLV/PM AOLV/PM CLV/PM EZOLV </div> Sets the command to operate the motor in reverse at the Jog Frequency set in <i>d1-17 [Jog Reference]</i> .

Note:

- It is not necessary to input the Run command.
- The Reverse JOG command has priority over all other frequency references.
- When the Forward JOG and Reverse JOG commands are activated at the same time for 500 ms or longer, the drive will ramp to stop.

14: Fault Reset

Setting Value	Function	Description
14	Fault Reset Procedure	<div style="display: flex; justify-content: space-between; font-size: small;"> V/f CL-V/f OLV CLV AOLV OLV/PM AOLV/PM CLV/PM EZOLV </div> Sets the command to reset the current fault when the Run command is inactive.

If the drive detects a fault, the drive will activate the fault relay output, turn off the output, and the motor will coast to stop.

If the drive detects a fault for which you can set the stopping method, apply the appropriate Stopping Method. Then push  (RESET) on the keypad to turn the Run command OFF, or activate the fault reset terminal to reset the fault.

Note:

The drive ignores the fault reset command when the Run command is active. Remove the Run command before trying to reset a fault.

15: Fast Stop (N.O.)

Setting Value	Function	Description
15	Fast Stop (N.O.)	<div style="display: flex; justify-content: space-between; font-size: small;"> V/f CL-V/f OLV CLV AOLV OLV/PM AOLV/PM CLV/PM EZOLV </div> Sets the command to ramp to stop in the deceleration time set in C1-09 [Fast Stop Time] when the input terminal is activated while the drive is operating.

If you cancel the fast stop input, the drive will not restart the motor until you meet these conditions:

- Fully stop the motor
- Cancel the Run command
- Cancel the fast stop command

Note:

- To use the N.C. switch to input the fast stop command, set 17 (Fast Stop (N.C.)).
- For details, refer to C1-09 [Fast Stop Time].
- Set C1-09 [Fast Stop Time] to a correct deceleration time. If the deceleration time is too short, it can cause an overvoltage fault and failure to stop the motor from coasting.

16: Motor 2 Selection

Setting Value	Function	Description
16	Motor 2 Selection	<div style="display: flex; justify-content: space-between; font-size: small;"> V/f CL-V/f OLV CLV AOLV OLV/PM AOLV/PM CLV/PM EZOLV </div> Sets the command for the drive to operate motor 1 or motor 2. Stop the motors before switching.

You can use an external input to switch operation between two induction motors. The drive will save the control methods, V/f patterns, and motor parameters for the two motors.

ON : Selects motor 2

OFF : Selects motor 1

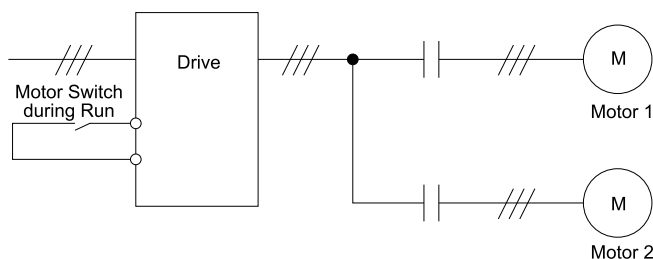

When you select motor 2, the drive will switch to motor 2 parameters.

Table 12.57 Parameters that Switch between Motor 1 and Motor 2

Parameter	Motor 2 Selection	
	OFF (Motor 1)	ON (Motor 2)
C1-xx [Accel & Decel Time]	C1-01 to C1-04	C1-05 to C1-08
C3-xx [Slip Compensation]	C3-01 to C3-04	C3-21 to C3-24
C4-xx [Torque Compensation]	C4-01	C4-07

Parameter	Motor 2 Selection	
	OFF (Motor 1)	ON (Motor 2)
C5-xx [Automatic Speed Regulator (ASR)]	C5-01 to C5-08, C5-12, C5-17, C5-18	C5-21 to C5-28, C5-32, C5-37, C5-38
E1-xx, E3-xx [V/f Patterns] E2-xx, E4-xx [Motor Parameters]	E1-xx, E2-xx	E3-xx, E4-xx
F1-xx [Number of PG pulses per Revolution]	F1-01 to F1-21	F1-02 to F1-04, F1-08 to F1-11, F1-14, F1-31 to F1-37

Note:

- When you use 2 motors, the drive applies the protective function set in *L1-01 [Motor Overload Protection Select]* to motor 1 and motor 2.
- You cannot switch between motors 1 and 2 during run. If you try to switch motors when they are running, it will cause a *rUn* error.
- After you switch between encoder motors, you must wait 500 ms minimum to input a Run command. You must wait 200 ms minimum for other control methods.
- If you set *H1-xx=16 [Motor Switch Command]* and set different control methods in maximum output frequency to motors 1 and 2, the drive will apply the lower of the two maximum to the two motors. The upper limit of *d1-xx [Frequency Reference]* will change. For example, the upper limit of *d1-xx* will be 400 when you set these parameters to these values:
 - A1-02 = 2 [Control Method Selection = OLV]
 - E1-04 = 590 [Maximum Output Frequency = 590 Hz]
 - E3-01 = 3 [Motor 2 Control Mode Selection = CLV]
 - E3-04 = 400 [Motor 2 Maximum Output Frequency = 400 Hz]

■ 17: Fast Stop (N.C.)

Setting Value	Function	Description
17	Fast Stop (N.C.)	<div style="display: flex; justify-content: space-between; font-size: small;"> V/f CL-V/f OLV CLV AOLV OLV/PM AOLV/PM CLV/PM EZOLV </div> <p>Sets the command to ramp to stop in the deceleration time set in <i>C1-09 [Fast Stop Time]</i> when the input terminal is activated while the drive is operating.</p>

If you cancel the fast stop input, the drive will not restart the motor until you meet these conditions:

- Fully stop the motor
- Cancel the Run command
- Cancel the fast stop command

Note:

- To use the N.O. switch to input the fast stop command, set 15 (Fast Stop (N.O.)).
- For details, refer to *C1-09 [Fast Stop Time]*.
- Set *C1-09 [Fast Stop Time]* to a correct deceleration time. If the deceleration time is too short, it can cause an overvoltage fault and failure to stop the motor from coasting.

Figure 12.82 shows an example of how fast stop operates.

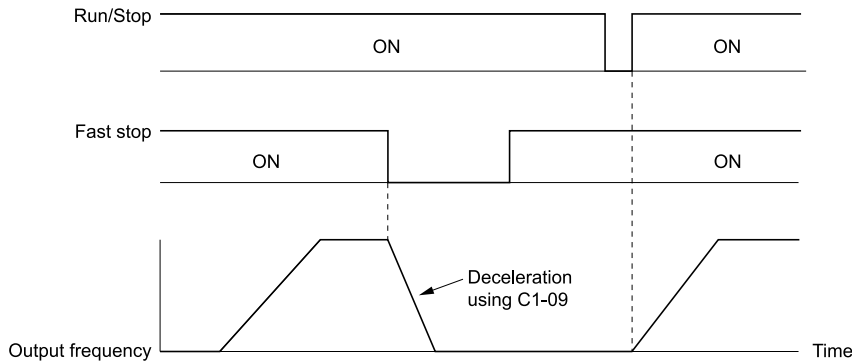

Figure 12.82 Fast Stop Time Chart

■ 18: Timer Function

Setting Value	Function	Description
18	Timer Function	<div style="display: flex; justify-content: space-between; font-size: small;"> V/f CL-V/f OLV CLV AOLV OLV/PM AOLV/PM CLV/PM EZOLV </div> <p>Sets the command to start the timer function. Use this setting with <i>Timer Output [H2-xx = 12]</i>.</p>

Note:

Refer to “b4: Timer Function” for more information.

■ 19: PID Disable

Setting Value	Function	Description
19	PID Disable	<div style="display: flex; justify-content: space-between; align-items: center;"> V/f CL-V/f OLV CLV AOLV OLV/PM AOLV/PM CLV/PM EZOLV </div> <p>Sets the command to disable PID control when $b5-01 = 1$ to 8 [PID Mode Setting = Enabled].</p>

ON : PID control disabled

OFF : PID control enabled

■ 1A: Accel/Decel Time Selection 2

Setting Value	Function	Description
1A	Accel/Decel Time Selection 2	<div style="display: flex; justify-content: space-between; align-items: center;"> V/f CL-V/f OLV CLV AOLV OLV/PM AOLV/PM CLV/PM EZOLV </div> <p>Set this function and $H1-xx = 7$ [Accel/Decel Time Selection 1] together. Sets the drive to use Acceleration/Deceleration Time 3 [C1-05, C1-06] or Acceleration/Deceleration Time 4 [C1-07, C1-08].</p>

Note:

Refer to “C1: Accel & Decel Time” for more information.

■ 1B: Programming Lockout

Setting Value	Function	Description
1B	Programming Lockout	<div style="display: flex; justify-content: space-between; align-items: center;"> V/f CL-V/f OLV CLV AOLV OLV/PM AOLV/PM CLV/PM EZOLV </div> <p>Sets the command to prevent parameter changes when the terminal is OFF.</p>

You can continue to view parameter setting values when the terminal is OFF [Parameters Cannot be Edited].

ON : Program Lockout

OFF : Parameter Write Prohibit

■ 1E: Reference Sample Hold

Setting Value	Function	Description
1E	Reference Sample Hold	<div style="display: flex; justify-content: space-between; align-items: center;"> V/f CL-V/f OLV CLV AOLV OLV/PM AOLV/PM CLV/PM EZOLV </div> <p>Sets the command to sample the frequency reference at terminals A1, A2, or A3 and hold the frequency reference at that frequency.</p>

When the terminal is active for 100 ms, this function reads a sample of the analog frequency reference and holds that sample. When you input the sample/hold command again, the function reads a sample of the analog frequency reference again and holds that sample. When you turn off the power, the drive erases the saved analog frequency and resets the frequency reference to 0.

Figure 12.83 shows an example of how the function operates.

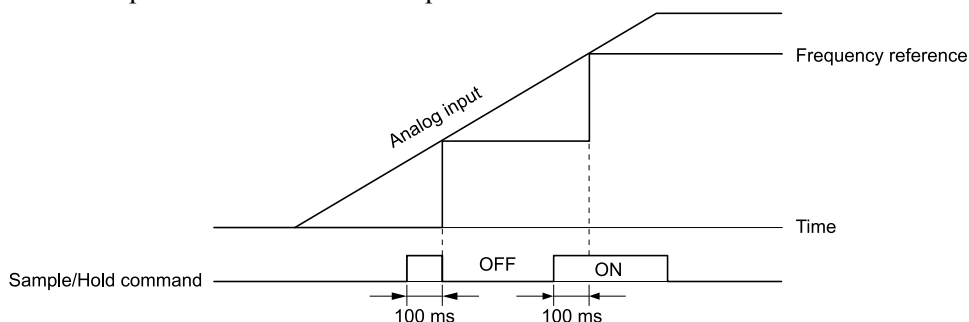

Figure 12.83 Reference Sample Hold

You cannot set the Reference Sample Hold function at the same time as these functions:

- $H1-xx = A$ [Accel/Decel Ramp Hold]
- $H1-xx = 10, 11$ [Up Command, Down Command]
- $H1-xx = 44$ to 46 [Offset Frequency 1 to 3]

- $H1-xx = 75, 76$ [Up 2 Command, Down 2 Command]

If you set them at the same time, the drive will detect $oPE03$ [Multi-Function Input Setting Err].

■ 20 to 2F: External Fault

Setting Value	Function	Description
20 to 2F	External fault	<div style="display: flex; justify-content: space-between; align-items: center;"> V/f CL-V/f OLV CLV AOLV OLV/PM AOLV/PM CLV/PM EZOLV </div> Sets a command to stop the drive when a failure or fault occurs on an external device.

If an external fault is input to the drive, the keypad will show EFx [External Fault (Terminal Sx)], where x is the number of the terminal (terminal Sx) to which the external fault signal is assigned. For example, when an external fault signal is input to terminal S3, the keypad will show EF3.

Use these conditions to select the value to set in $H1-xx$:

- Signal input method from peripheral devices
- External fault detection method
- Motor stopping method (operation after external fault detection)

Table 12.58 shows the relation between the conditions and the value set to $H1-xx$.

Table 12.58 Stopping Methods for External Fault

Setting	Signal Input Method from Peripheral Devices *1		External Fault Detection Method *2		Stopping Method			
	N.O.	N.C.	Always Detected	Detected during RUN Only	Ramp to Stop (Fault)	Coast to Stop (Fault)	Fast Stop (Fault)	Continuous Operation (Alarm Only)
20	x	-	x	-	x	-	-	-
21	-	x	x	-	x	-	-	-
22	x	-	-	x	x	-	-	-
23	-	x	-	x	x	-	-	-
24	x	-	x	-	-	x	-	-
25	-	x	x	-	-	x	-	-
26	x	-	-	x	-	x	-	-
27	-	x	-	x	-	x	-	-
28	x	-	x	-	-	-	x	-
29	-	x	x	-	-	-	x	-
2A	x	-	-	x	-	-	x	-
2B	-	x	-	x	-	-	x	-
2C	x	-	x	-	-	-	-	x
2D	-	x	x	-	-	-	-	x
2E	x	-	-	x	-	-	-	x
2F	-	x	-	x	-	-	-	x

*1 Set the terminal to N.O. (detects external fault when switched ON) or N.C. (detects external fault when switched OFF).

*2 Set the drive to always detect each fault or to detect only during run.

■ 30: PID Integrator Reset

Setting Value	Function	Description
30	PID Integrator Reset	<div style="display: flex; justify-content: space-between; align-items: center;"> V/f CL-V/f OLV CLV AOLV OLV/PM AOLV/PM CLV/PM EZOLV </div> Sets the command to reset and hold the PID control integral to 0 when the terminal is ON.

Note:

Refer to “PID control block diagram” for more information.

■ 31: PID Integrator Hold

Setting Value	Function	Description
31	PID Integrator Hold	V/f CL-V/f OLV CLV AOLV OLV/PM AOLV/PM CLV/PM EZOLV Sets the command to hold the integral value of the PID control while the terminal is activated.

When you turn off the input terminal, PID control restarts the integral.

Note:

Refer to “PID control block diagram” for more information.

■ 32: Multi-Step Speed Reference 4

Setting Value	Function	Description
32	Multi-Step Speed Reference 4	V/f CL-V/f OLV CLV AOLV OLV/PM AOLV/PM CLV/PM EZOLV Uses speed references <i>d1-01</i> to <i>d1-16</i> to set a multi-step speed reference.

Note:

Refer to "Setting Procedures for Multi-step Speed Operation" in “d: Reference Settings” for more information.

■ 34: PID Soft Starter Disable

Setting Value	Function	Description
34	PID Soft Starter Disable	V/f CL-V/f OLV CLV AOLV OLV/PM AOLV/PM CLV/PM EZOLV Sets the PID soft starter function.

ON : Disabled

Disables *b5-17* [PID Accel/Decel Time].

OFF : Enabled

Enables *b5-17* [PID Accel/Decel Time].

Note:

Refer to “PID control block diagram” for more information.

■ 35: PID Input (Error) Invert

Setting Value	Function	Description
35	PID Input (Error) Invert	V/f CL-V/f OLV CLV AOLV OLV/PM AOLV/PM CLV/PM EZOLV Sets the command to turn the terminal ON and OFF to switch the PID input level (polarity).

Note:

Refer to “PID control block diagram” for more information.

■ 3E: PID Setpoint Selection 1

Setting Value	Function	Description
3E	PID Setpoint Selection 1	V/f CL-V/f OLV CLV AOLV OLV/PM AOLV/PM CLV/PM EZOLV Set this function and <i>H1-xx = 3F</i> [PID Setpoint Selection 2] together. Sets the function to switch the PID setpoint to <i>b5-58</i> to <i>b5-60</i> [PID Setpoint 2 to 4].

Refer to “b5-58 to b5-60: PID Setpoint 2 to 4” for more information.

■ 3F: PID Setpoint Selection 2

Setting Value	Function	Description
3F	PID Setpoint Selection 2	V/f CL-V/f OLV CLV AOLV OLV/PM AOLV/PM CLV/PM EZOLV Set this function and <i>H1-xx = 3E</i> [PID Setpoint Selection 1] at the same time. Sets the function to switch the PID setpoint to <i>b5-58</i> to <i>b5-60</i> [PID Setpoint 2 to 4].

Refer to “b5-58 to b5-60: PID Setpoint 2 to 4” for more information.

■ 40: Forward RUN (2-Wire)

Setting Value	Function	Description
40	Forward RUN (2-Wire)	<div style="display: flex; justify-content: space-between; font-size: small;"> V/f CL-V/f OLV CLV AOLV OLV/PM AOLV/PM CLV/PM EZOLV </div> <p>Sets the Forward Run command for 2-wire sequence 1. Set this function and $H1-xx = 41$ [Reverse Run Command (2-Wire Seq)] at the same time.</p>

ON : Forward Run

OFF : Run Stop

Note:

- Turning ON the Forward Run command terminal and the Reverse Run command terminal will cause alarm *EF* [FWD/REV Run Command Input Error] and the motor will ramp to stop.
- Initialize the drive with a 2-wire sequence to set the Forward Run command to terminal S1.
- This function will not operate at the same time as $H1-xx = 42, 43$ [Run Command/FWD/REV Command (2-Wire Seq 2)].

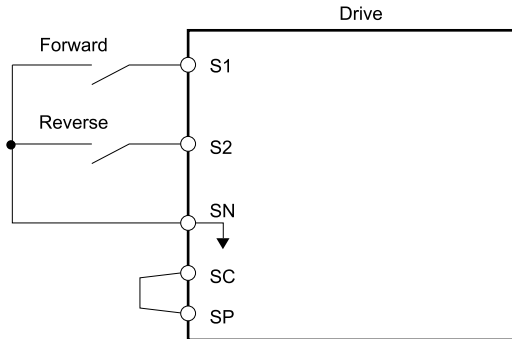

Figure 12.84 2-Wire Sequence Wiring Example

■ 41: Reverse RUN (2-Wire)

Setting Value	Function	Description
41	Reverse RUN (2-Wire)	<div style="display: flex; justify-content: space-between; font-size: small;"> V/f CL-V/f OLV CLV AOLV OLV/PM AOLV/PM CLV/PM EZOLV </div> <p>Sets the Forward Run command for 2-wire sequence 1. Set this function and $H1-xx = 40$ [Forward Run Command (2-Wire Seq)] at the same time.</p>

ON : Reverse Run

OFF : Run Stop

Note:

- Turning ON the Forward Run command terminal and the Reverse Run command terminal will cause alarm *EF* [FWD/REV Run Command Input Error] and the motor will ramp to stop.
- Initialize the drive with a 2-wire sequence to set the Reverse Run command to terminal S2.
- This function will not operate at the same time as $H1-xx = 42, 43$ [Run Command/FWD/REV Command (2-Wire Seq 2)].

■ 42: Run Command (2-Wire Sequence 2)

Setting Value	Function	Description
42	Run Command (2-Wire Sequence 2)	<div style="display: flex; justify-content: space-between; font-size: small;"> V/f CL-V/f OLV CLV AOLV OLV/PM AOLV/PM CLV/PM EZOLV </div> <p>Sets the Run command for 2-wire sequence 2. Set this function and $H1-xx = 43$ [FWD/REV Command (2-Wire Seq 2)] at the same time.</p>

ON : Run

OFF : Stop

Note:

This function will not operate at the same time as $H1-xx = 40, 41$ [Forward/Reverse Run Command (2-Wire Seq)].

■ 43: FWD/REV (2-Wire Sequence 2)

Setting Value	Function	Description
43	FWD/REV (2-Wire Sequence 2)	<div style="display: flex; justify-content: space-between; gap: 5px;"> V/f CL-V/f OLV CLV AOLV OLV/PM AOLV/PM CLV/PM EZOLV </div> <p>Sets the direction of motor rotation for 2-wire sequence 2. Set this function and $H1-xx = 42$ [Run Command (2-Wire Sequence 2)] together.</p>

ON : Reverse

OFF : Forward

Note:

- You must input the Run command to rotate the motor.
- This function will not operate at the same time as $H1-xx = 40, 41$ [Forward/Reverse Run Command (2-Wire Seq)].

■ 44: Add Offset Frequency 1 (d7-01)

Setting Value	Function	Description
44	Offset Frequency 1	<div style="display: flex; justify-content: space-between; gap: 5px;"> V/f CL-V/f OLV CLV AOLV OLV/PM AOLV/PM CLV/PM EZOLV </div> <p>Sets the function to add the offset frequency set in $d7-01$ [Offset Frequency 1] to the frequency reference when the terminal activates.</p>

Note:

Refer to “d7: Offset Frequency” for more information.

■ 45: Add Offset Frequency 2 (d7-02)

Setting Value	Function	Description
45	Offset Frequency 2	<div style="display: flex; justify-content: space-between; gap: 5px;"> V/f CL-V/f OLV CLV AOLV OLV/PM AOLV/PM CLV/PM EZOLV </div> <p>Sets the function to add the offset frequency set in $d7-02$ [Offset Frequency 2] to the frequency reference when the terminal activates.</p>

Note:

Refer to “d7: Offset Frequency” for more information.

■ 46: Add Offset Frequency 3 (d7-03)

Setting Value	Function	Description
46	Offset Frequency 3	<div style="display: flex; justify-content: space-between; gap: 5px;"> V/f CL-V/f OLV CLV AOLV OLV/PM AOLV/PM CLV/PM EZOLV </div> <p>Sets the function to add the offset frequency set in $d7-03$ [Offset Frequency 3] to the frequency reference when the terminal activates.</p>

Note:

Refer to “d7: Offset Frequency” for more information.

■ 47: Node Setup (CANopen)

Setting Value	Function	Description
47	Node Setup (CANopen)	<div style="display: flex; justify-content: space-between; gap: 5px;"> V/f CL-V/f OLV CLV AOLV OLV/PM AOLV/PM CLV/PM EZOLV </div> <p>Sets the function in CANopen communications to start the Node Setup function to set the drive node address from the host controller.</p>

■ 60: DC Injection Braking Command

Setting Value	Function	Description
60	DC Injection Braking Command	<div style="display: flex; justify-content: space-between; gap: 5px;"> V/f CL-V/f OLV CLV AOLV OLV/PM AOLV/PM CLV/PM EZOLV </div> <p>Sets the command to use DC Injection Braking to stop the motor.</p>

If you input the Run command or JOG command, it will cancel DC Injection Braking.

Figure 12.85 shows the time chart of the DC Injection Braking function.

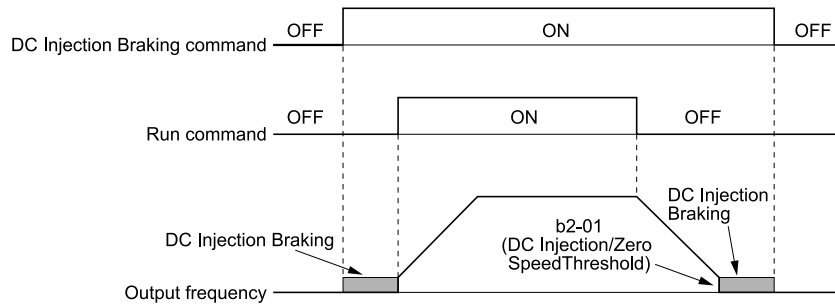

Figure 12.85 DC Injection Braking Time Chart

Note:

- When $A1-02 = 8$ [Control Method Selection = EZOLV], this function is available only when you use a PM motor.
- Refer to "b2: DC Injection Braking and Short Circuit Braking" for more information.

■ **61: Speed Search from Fmax**

Setting Value	Function	Description
61	Speed Search from Fmax	<input checked="" type="checkbox"/> V/f <input type="checkbox"/> CL-V/f <input type="checkbox"/> OLV <input type="checkbox"/> CLV <input type="checkbox"/> AOLV <input type="checkbox"/> OLV/PM <input type="checkbox"/> AOLV/PM <input type="checkbox"/> CLV/PM <input type="checkbox"/> EZOLV Sets the function to start speed search using an external reference although $b3-01 = 0$ [Speed Search Selection at Start = Disabled].

When the terminal is turned ON for $b3-24 = 2$ [Speed Search Method Selection = Current Detection 2], the drive starts speed search from the maximum output frequency.

Note:

- The drive will detect $oPE03$ [Multi-Function Input Setting Err] when $H1-xx = 61$ and 62 are set at the same time.
- Refer to “b3: Speed Search” for more information.

■ **62: Speed Search from Fref**

Setting Value	Function	Description
62	Speed Search from Fref	<input checked="" type="checkbox"/> V/f <input type="checkbox"/> CL-V/f <input type="checkbox"/> OLV <input type="checkbox"/> CLV <input type="checkbox"/> AOLV <input type="checkbox"/> OLV/PM <input type="checkbox"/> AOLV/PM <input type="checkbox"/> CLV/PM <input type="checkbox"/> EZOLV Sets the function to use an external reference to start speed search although $b3-01 = 0$ [Speed Search Selection at Start = Disabled].

When the terminal is turned ON for $b3-24 = 2$ [Speed Search Method Selection = Current Detection 2], the drive starts speed search from the frequency reference.

Note:

- The drive will detect $oPE03$ [Multi-Function Input Setting Err] when $H1-xx = 61$ and 62 are set at the same time.
- Refer to “b3: Speed Search” for more information.

■ **63: Field Weakening**

Setting Value	Function	Description
63	Field Weakening	<input checked="" type="checkbox"/> V/f <input type="checkbox"/> CL-V/f <input type="checkbox"/> OLV <input type="checkbox"/> CLV <input type="checkbox"/> AOLV <input type="checkbox"/> OLV/PM <input type="checkbox"/> AOLV/PM <input type="checkbox"/> CLV/PM <input type="checkbox"/> EZOLV Sets the function to send the Field Weakening Level and Field Weakening Frequency Limit commands set in $d6-01$ [Field Weakening Level] and $d6-02$ [Field Weakening Frequency Limit] when the input terminal is activated.

Note:

Refer to “d6: Field Weak & Field Force” for more information.

■ **65: KEB Ride-Thru 1 Activate (N.C.)**

Setting Value	Function	Description
65	KEB Ride-Thru 1 Activate (N.C.)	<input checked="" type="checkbox"/> V/f <input type="checkbox"/> CL-V/f <input type="checkbox"/> OLV <input type="checkbox"/> CLV <input type="checkbox"/> AOLV <input type="checkbox"/> OLV/PM <input type="checkbox"/> AOLV/PM <input type="checkbox"/> CLV/PM <input type="checkbox"/> EZOLV Sets operation of the KEB1 function through the KEB Ride-Thru 1 (N.C.).

ON : Normal operation

OFF : Deceleration during momentary power loss

When you enable KEB Ride-Thru 1, set $L2-29$ [KEB Method Selection]. The drive operates with the selected KEB method.

Note:

- If you set *KEB Ride-Thru 1* [*H1-xx = 65, 66*] and *KEB Ride-Thru 2* [*H1-xx = 7A, 7B*] at the same time, the drive will detect *oPE03* [*Multi-Function Input Setting Err*].
- Refer to “KEB Ride-Thru function” for more information.

■ 66: KEB Ride-Thru 1 Activate (N.O.)

Setting Value	Function	Description
66	KEB Ride-Thru 1 Activate (N.O.)	<div style="display: flex; justify-content: space-between; align-items: center;"> V/f CL-V/f OLV CLV AOLV OLV/PM AOLV/PM CLV/PM EZOLV </div> Sets operation of the KEB1 function through the KEB Ride-Thru 1 (N.O.).

ON : Deceleration during momentary power loss

OFF : Normal operation

When you enable KEB Ride-Thru 1, set *L2-29* [*KEB Method Selection*]. The drive operates with the selected KEB method.

Note:

- If you set *KEB Ride-Thru 1* [*H1-xx = 65, 66*] and *KEB Ride-Thru 2* [*H1-xx = 7A, 7B*] at the same time, the drive will detect *oPE03* [*Multi-Function Input Setting Err*].
- Refer to "KEB Ride-Thru function" for more information.

■ 67: Communications Test Mode

Setting Value	Function	Description
67	Communications Test Mode	<div style="display: flex; justify-content: space-between; align-items: center;"> V/f CL-V/f OLV CLV AOLV OLV/PM AOLV/PM CLV/PM EZOLV </div> Set the function for the drive to self-test RS-485 serial communications operation.

The Self-Diagnostics function connects the transmission terminal of the control terminal block to the reception terminal. The function transmits the data that the drive sent to make sure that the drive can communicate correctly.

Note:

Refer to MEMOBUS/Modbus communications “Self-Diagnostics” for the self-diagnostics procedure.

■ 68: High Slip Braking (HSB) Activate

Setting Value	Function	Description
68	High Slip Braking	<div style="display: flex; justify-content: space-between; align-items: center;"> V/f CL-V/f OLV CLV AOLV OLV/PM AOLV/PM CLV/PM EZOLV </div> Sets the command to use high-slip braking to stop the motor.

Note:

- When you restart the drive after you use high-slip braking, make sure that the drive fully stops the motor then clear the high-slip braking input.
- Refer to “n3: High Slip/Overex Braking” for more information.

■ 6A: Drive Enable

Setting Value	Function	Description
6A	Drive Enable	<div style="display: flex; justify-content: space-between; align-items: center;"> V/f CL-V/f OLV CLV AOLV OLV/PM AOLV/PM CLV/PM EZOLV </div> Sets the function to show <i>dnE</i> [<i>Drive Enabled</i>] on the keypad and ignore Run commands when the terminal is OFF.

If you input the Run command before you turn ON the Drive Enable terminal, you must input the Run command again to operate the drive. When the terminal set for Drive Enable is turned OFF when the drive is operating, the drive will use the stopping method set in *b1-03* [*Stopping Method Selection*] to stop the motor.

ON : Run command is accepted.

OFF : Run command is disabled. When the drive is running, it stops according to *b1-03* setting.

■ 71: Torque Control

Setting Value	Function	Description
71	Torque Control	<div style="display: flex; justify-content: space-between; align-items: center;"> V/f CL-V/f OLV CLV AOLV OLV/PM AOLV/PM CLV/PM EZOLV </div> Sets the function to switch between torque control and speed control.

ON : Torque control

OFF : Speed control**Note:**

When this function is enabled, set $d5-01 = 0$ [Torque Control Selection = Speed Control].

Input the Speed/Torque Control Switchover Time

Use parameter $d5-06$ [Speed/Torque Changeover Time] to set the length of time, in milliseconds, that the drive will wait to switch between speed and torque control. When the speed/torque control switchover signal changes in the time set in $d5-06$, the three analog inputs will keep their present value. Complete the signal switchover with an external source in this time.

Note:

Refer to "Switch Speed Control and Torque Control" for more information.

72: Zero Servo

Setting Value	Function	Description
72	Zero Servo	<div style="display: flex; justify-content: space-between; font-size: small;"> V/f CL-V/f OLV CLV AOLV OLV/PM AOLV/PM CLV/PM EZOLV </div> <p>Sets the function to hold a stopped motor.</p>

This function will hold a stopped motor if an external force is applied or an analog reference is offset.

Note:

- Refer to "b9: Zero Servo" for more information.
- When you use the Zero Servo function, keep the Run command ON. Zero servo stops the motor and if you turn OFF the Run command, it will not have power.

75: Up 2 Command

Setting Value	Function	Description
75	Up 2 Command	<div style="display: flex; justify-content: space-between; font-size: small;"> V/f CL-V/f OLV CLV AOLV OLV/PM AOLV/PM CLV/PM EZOLV </div> <p>Sets the function to increase the frequency reference bias value to accelerate the motor when the terminal is activated. Set this function and $H1-xx = 76$ [Down 2 Command] together.</p>

When you activate the terminal set for Up2 Command, the bias will increase. When you activate the terminal set for Down 2 Command, the bias will decrease. When you activate or deactivate the two commands, the drive will hold the frequency reference. [Table 12.59](#) gives information about the relation between operation of the Up/Down 2 Command and $d4-01$, $d4-03$, $d4-05$.

Note:

- When you use this function, use $d4-08$ and $d4-09$ [Up/Down 2 Bias Upper Limit/Lower Limit] to set the optimal bias limit value.
- Refer to "d4: Frequency Ref Up/Down & Hold" for more information.

Table 12.59 Up 2 Command, Down 2 Command

Function	Frequency Reference Source	d4-03	d4-05	d4-01	Operation	Storing the Frequency Reference or Frequency Bias		
1	Multi-step speed reference	0.00	0	0	<ul style="list-style-type: none"> When the Up 2 Command is active, the drive accelerates the motor (increases the bias value). When the Down 2 Command is active, the drive decelerates the motor (decreases the bias value) When the Up 2 Command and Down 2 Command are not active and when the Up 2 Command and Down 2 Command are active, the drive holds the output frequency (holds the bias value). When the frequency changes, it will reset the bias. For all other statuses, the drive will follow the frequency reference. 	Not stored.		
2				1		<ul style="list-style-type: none"> When the Up 2 Command is active, the drive accelerates the motor. When the Down 2 Command is active, the drive decelerates the motor. For all other statuses, the drive will follow the frequency reference. 	When the bias value and frequency reference are constant for 5 seconds after the frequency reference hold starts, the drive will add the bias value to the enabled frequency reference, then reset.	
3				-				
4	Multi-step speed reference	> 0	-	0	<ul style="list-style-type: none"> When the Up 2 Command is active, the drive accelerates the motor to "Frequency Reference + d4-03" (the bias value will increase to the value set in d4-03) When the Down 2 Command is active, the drive decelerates the motor to "Frequency Reference - d4-03" (the bias value will decrease to the value set in d4-03). When the Up 2 Command and Down 2 Command are not active and when the Up 2 Command and Down 2 Command are active, the drive holds the output frequency (holds the bias value). When the frequency changes, it will reset the bias. For all other statuses, the drive will follow the frequency reference. 	Not stored.		
5				1		<ul style="list-style-type: none"> When the Up 2 Command is active, the drive accelerates the motor (increases the bias value). When the Down 2 Command is active, the drive decelerates the motor (decreases the bias value) When the Up 2 Command and Down 2 Command are not active and when the Up 2 Command and Down 2 Command are active, the drive holds the output frequency (holds the bias value). During acceleration or deceleration, when the frequency reference increases or decreases more than d4-07, the drive holds the bias value until the output frequency and the actual frequency reference agree (speed agreement). 	When the bias value and frequency reference are constant for 5 seconds after the frequency reference hold starts, the drive will add the bias value to the enabled frequency reference, then reset.	
6	Others (Analog input, transmission)	0	0	0	<ul style="list-style-type: none"> When the Up 2 Command is active, the drive accelerates the motor (increases the bias value). When the Down 2 Command is active, the drive decelerates the motor (decreases the bias value) When the Up 2 Command and Down 2 Command are not active and when the Up 2 Command and Down 2 Command are active, the drive holds the output frequency (holds the bias value). During acceleration or deceleration, when the frequency reference increases or decreases more than d4-07, the drive holds the bias value until the output frequency and the actual frequency reference agree (speed agreement). 			Not stored.
7				1				
8	Others (Analog input, transmission)	0	1	-	<ul style="list-style-type: none"> When the Up 2 Command is active, the drive accelerates the motor (increases the bias value). When the Down 2 Command is active, the drive decelerates the motor (decreases the bias value) For all other statuses, the drive will follow the frequency reference. 	Not stored.		
9						0	<ul style="list-style-type: none"> When the Up 2 Command is active, the drive accelerates the motor to "Frequency Reference + d4-03" (the bias value will increase to the value set in d4-03) When the Down 2 Command is active, the drive decelerates the motor to "Frequency Reference - d4-03" (the bias value will decrease to the value set in d4-03). During acceleration or deceleration, when the frequency reference increases or decreases more than d4-07, the drive holds the bias value until the output frequency and the actual frequency reference agree (speed agreement). 	Not stored.
10						1		When the bias value is constant for 5 seconds after the frequency reference hold starts, the drive will store the bias value in d4-06. You cannot rewrite the frequency reference is not possible. The drive will store only the bias value.

■ 76: Down 2 Command

Setting Value	Function	Description
76	Down 2 Command	<p>V/f CL-V/f OLV CLV AOLV OLV/PM AOLV/PM CLV/PM EZOLV</p> <p>Sets the function to decrease the frequency reference bias value to decelerate the motor when the terminal is activated. Set this function and H1-xx = 75 [Up 2 Command] at the same time.</p>

When you activate the terminal set for Up2 Command, the bias will increase. When you activate the terminal set for Down 2 Command, the bias will decrease. When you activate or deactivate the two commands, the drive will hold the frequency reference.

Note:

- When using this function, set the optimal bias limit value with *d4-08 and d4-09 [Up/Down 2 Bias Upper Limit/Lower Limit]*.
- Refer to “d4: Frequency Ref Up/Down & Hold” for more information.

■ **77: ASR Gain (C5-03) Select**

Setting Value	Function	Description
77	ASR Gain (C5-03) Select	<div style="display: flex; justify-content: space-between; align-items: center;"> V/f CL-V/f OLV CLV AOLV OLV/PM AOLV/PM CLV/PM EZOLV </div> <p>Sets the function to switch the ASR proportional gain set in <i>C5-01 [ASR Proportional Gain 1]</i> and <i>C5-03 [ASR Proportional Gain 2]</i>.</p>

ON : C5-03

Switches the proportional gain to *C5-03 [ASR Proportional Gain 2]*.

OFF : C5-01

Switches the proportional gain to *C5-01 [ASR Proportional Gain 1]*.

Note:

Refer to “C5: Automatic Speed Regulator (ASR)” for more information.

■ **78: Analog TorqueRef Polarity Invert**

Setting Value	Function	Description
78	Analog TorqueRef Polarity Invert	<div style="display: flex; justify-content: space-between; align-items: center;"> V/f CL-V/f OLV CLV AOLV OLV/PM AOLV/PM CLV/PM EZOLV </div> <p>Sets the rotation direction of the external torque reference.</p>

ON : External torque reference reverse direction

OFF : External torque reference forward direction

■ **7A: KEB Ride-Thru 2 Activate (N.C.)**

Setting Value	Function	Description
7A	KEB Ride-Thru 2 Activate (N.C.)	<div style="display: flex; justify-content: space-between; align-items: center;"> V/f CL-V/f OLV CLV AOLV OLV/PM AOLV/PM CLV/PM EZOLV </div> <p>Sets operation of the KEB2 function through the KEB Ride-Thru 2 (N.C.).</p>

ON : Normal operation

OFF : Deceleration during momentary power loss

When KEB Ride-Thru 2 is input, the drive will use Single Drive KEB Ride-Thru 2 for KEB operation. The *L2-29 [KEB Method Selection]* setting will not have an effect.

Note:

- If you set *KEB Ride-Thru 1 [H1-xx = 65, 66]* and *KEB Ride-Thru 2 [H1-xx = 7A, 7B]* at the same time, the drive will detect *oPE03 [Multi-Function Input Setting Err]*.
- Refer to “KEB Ride-Thru function” for more information.

■ **7B: KEB Ride-Thru 2 Activate (N.O.)**

Setting Value	Function	Description
7B	KEB Ride-Thru 2 Activate (N.O.)	<div style="display: flex; justify-content: space-between; align-items: center;"> V/f CL-V/f OLV CLV AOLV OLV/PM AOLV/PM CLV/PM EZOLV </div> <p>Sets operation of the KEB2 function through the KEB Ride-Thru 2 (N.O.).</p>

ON : Deceleration during momentary power loss

OFF : Normal operation

When KEB Ride-Thru 2 is input, the drive will use Single Drive KEB Ride-Thru 2 for KEB operation. The *L2-29 [KEB Method Selection]* setting will not have an effect.

Note:

- If you set *KEB Ride-Thru 1 [H1-xx = 65, 66]* and *KEB Ride-Thru 2 [H1-xx = 7A, 7B]* at the same time, the drive will detect *oPE03 [Multi-Function Input Setting Err]*.
- Refer to “KEB Ride-Thru function” for more information.

■ 7C: Short Circuit Braking (N.O.)

Setting Value	Function	Description
7C	Short Circuit Braking (N.O.)	<div style="display: flex; justify-content: space-between; font-size: small;"> V/f CL-V/f OLV CLV AOLV OLV/PM AOLV/PM CLV/PM EZOLV </div> Sets operation of Short Circuit Braking (N.O.).

The drive will short circuit the three phases of a PM motor to cause braking torque in the spinning motor.

Note:

- When $A1-02 = 8$ [Control Method Selection = EZOLV], this function is available only when you use a PM motor.
- Refer to "b2: DC Injection Braking and Short Circuit Braking" for more information.

ON : Short Circuit Braking is enabled.

OFF : Normal operation

■ 7D: Short Circuit Braking (N.C.)

Setting Value	Function	Description
7D	Short Circuit Braking (N.C.)	<div style="display: flex; justify-content: space-between; font-size: small;"> V/f CL-V/f OLV CLV AOLV OLV/PM AOLV/PM CLV/PM EZOLV </div> Sets operation of Short Circuit Braking (N.C.).

The drive will short circuit the three phases of a PM motor to cause braking torque in the spinning motor.

Note:

- When $A1-02 = 8$ [Control Method Selection = EZOLV], this function is available only when you use a PM motor.
- Refer to "b2: DC Injection Braking and Short Circuit Braking" for more information.

ON : Normal operation

OFF : Short Circuit Braking is enabled.

■ 7E: Reverse Rotation Identifier

Setting Value	Function	Description
7E	Reverse Rotation Identifier	<div style="display: flex; justify-content: space-between; font-size: small;"> V/f CL-V/f OLV CLV AOLV OLV/PM AOLV/PM CLV/PM EZOLV </div> Sets the rotation direction of the motor when in Simple Closed Loop V/f Control method and $F1-21, F1-37 = 0$ [Encoder Option Function Selection = A pulse detection], or when in Closed Loop V/f Control method.

ON : Reverse run

The drive knows that the motor is rotating in reverse .

OFF : Forward run

The drive knows that the motor is rotating forward .

■ 90 to 97: DriveWorksEZ Digital Inputs 1 to 8

Setting Value	Function	Description
90 - 97	DWEZ Digital Inputs 1 to 8	<div style="display: flex; justify-content: space-between; font-size: small;"> V/f CL-V/f OLV CLV AOLV OLV/PM AOLV/PM CLV/PM EZOLV </div> Sets digital inputs used with DriveWorksEZ. Refer to the DriveWorksEZ online manual for more information.

Note:

You cannot set values 90 to 97 for inverse output.

■ 9F: DWEZ Disable

Setting Value	Function	Description
9F	DWEZ Disable	<div style="display: flex; justify-content: space-between; font-size: small;"> V/f CL-V/f OLV CLV AOLV OLV/PM AOLV/PM CLV/PM EZOLV </div> Sets operation of the DriveWorksEZ program saved in the drive.

Note:

Set $A1-07 = 2$ [DriveWorksEZ Function Selection = Digital input] to use this function.

ON : Disabled

OFF : Enabled

■ **101 to 19F: Inverse Input of 1 to 9F**

Setting Value	Function	Description
101 to 19F	Inverse Inputs of 1 to 9F	Sets the function of the selected MFDI to operate inversely. To select the function, enter "1xx", where the "xx" is the function setting value.

For example, to use the inverse input of *E* [*ASR Integral Reset*], set *H1-xx = 10E*.

Note:

You cannot use inverse input for all functions. Refer to [Table 12.55](#) for more information.

◆ **H2: Digital Outputs**

H2 parameters set the MFDO terminal functions.

■ **H2-01 to H2-03 Terminal M1-M2, M3-M4, M5-M6 Function Selection**

The drive has three MFDO terminals. [Table 12.60](#) shows the default function settings for the terminals.

Table 12.60 MFDO Terminals Default Function Settings

No.	Name	Default	Function
H2-01	Term M1-M2 Function Selection	0	During Run
H2-02	Term M3-M4 Function Selection	1	Zero Speed
H2-03	Term M5-M6 Function Selection	2	Speed Agree 1

Refer to [Table 12.61](#) to set *H2-xx* [*MFDO Function Selection*].

Table 12.61 MFDO Setting Value

Setting Value	Function	Reference	Setting Value	Function	Reference
0	During Run	855	17	Torque Detection 1 (N.C.)	862
1	Zero Speed	855	18	Torque Detection 2 (N.O.)	863
2	Speed Agree 1	856	19	Torque Detection 2 (N.C.)	863
3	User-Set Speed Agree 1	857	1A	During reverse	863
4	Frequency Detection 1	857	1B	During Baseblock (N.C.)	863
5	Frequency Detection 2	858	1C	Motor 2 Selected	864
6	Drive ready	858	1D	During Regeneration	864
7	DC Bus Undervoltage	858	1E	Executing Auto-Restart	864
8	During Baseblock (N.O.)	859	1F	Motor Overload Alarm (oL1)	864
9	Frequency Reference from Keypad	859	20	Drive Overheat Pre-Alarm (oH)	864
A	Run Command from Keypad	859	21	Safe Torque OFF	864
B	Torque Detection 1 (N.O.)	859	22	Mechanical Weakening Detection	865
C	Frequency Reference Loss	859	2F	Maintenance Notification	865
D	Braking Resistor Fault	859	30	During Torque Limit	865
E	Fault	860	31	During Speed Limit	865
F <i>*J</i>	Not Used	860	32	In Speed Limit During Trq Ctrl	865
10	Alarm	860	33	Zero Servo Complete	866
11	Fault Reset Command Active	860	37	During Frequency Output	866
12	Timer Output	860	38	Drive Enabled	866
13	Speed Agree 2	860	39	Watt Hour Pulse Output	866
14	User-Set Speed Agree 2	861	3C	LOCAL Control Selected	866
15	Frequency Detection 3	861	3D	During Speed Search	867
16	Frequency Detection 4	862	3E	PID Feedback Low	867

Setting Value	Function	Reference
3F	PID Feedback High	867
4A	During KEB Ride-Thru	867
4B	During Short Circuit Braking	867
4C	During Fast Stop	867
4D	oH Pre-Alarm Reduction Limit	868
4E *2	Braking Transistor Fault (rr)	868
4F *2	Braking Resistor Overheat (rH)	868
60	Internal Cooling Fan Failure	868
61	Pole Position Detection Complete	868
62	Modbus Reg 1 Status Satisfied	868
63	Modbus Reg 2 Status Satisfied	868

Setting Value	Function	Reference
65	Standby Output	868
66	Comparator1	869
67	Comparator2	869
69	External Power 24V Supply	870
6A	Data Logger Error	870
90 - 93	DWEZ Digital Outputs 1 to 4	870
A0 to A7	DWEZ Extended Digital Outputs 1 to 8	870
100 to 1A7	Inverse Outputs of 0 to A7 Sets an inverse output of the function for the MFDO. Put a 1 at the front of the function setting to set inverse output. For example, set 138 for inverse output of 38 [Drive Enabled].	870

- *1 Inverse output is not available.
- *2 You cannot set this parameter on models 2169 to 2415 and 4089 to 4720.

■ Extend MFDO1 to MFDO3 Function Selection

You can set MFDO functions to *bit 0 to bit 2* [MEMOBUS MFDO1 to 3] of MEMOBUS register 15E0 (Hex.). Use *H2-40 to H2-42* [Mbus Reg 15E0h bit0 to bit2 Output Func] to select the function.

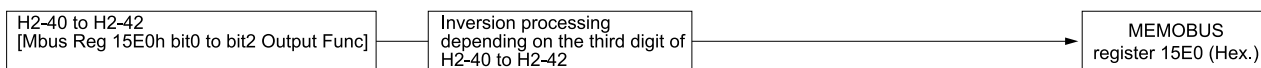

Figure 12.86 Functional Block Diagram of MEMOBUS Multi-function Output

Table 12.62 MEMOBUS MFDO Registers

Register No. (Hex.)	Name	
15E0	bit0	MEMOBUS MFDO 1
	bit1	MEMOBUS MFDO 2
	bit2	MEMOBUS MFDO 3

Note:

- Refer to H2-xx “MFDO Setting Values” for more information about MFDO setting values.
- When you do not set functions to *H2-40 to H2-42*, set them to *F*.

■ Output of Logical Operation Results of MFDO

This enables the logical operation results of two MFDOs to be output to one MFDO terminal.

Use *H2-60, H2-63, and H2-66* [Term M1-M2 Secondary Function to Term M5-M6 Secondary Function] to set the function of the output signal for which logical operations are performed.

Use *H2-61, H2-64, H2-67* [Term M1-M2 Logical Operation to Term M5-M6 Logical Operation] to set the logical operation.

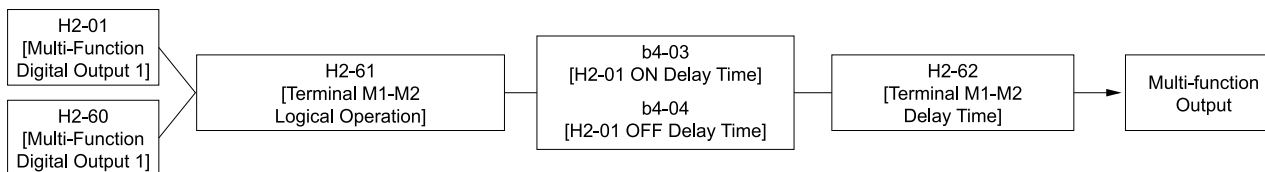

Figure 12.87 Functional Block Diagram of Logical Operation Output for MFDO 1

Table 12.63 MFDO Logical Operation Table

Logical Operation Selection	Logical Operation Expression	Logical Operation Notation
H2-61, H2-64, H2-67		
0	$A=B=1$	
1	$A=1 \text{ or } B=1$	
2	$A=0 \text{ or } B=0$	
3	$A=B=0$	
4	$A=B$	$A=B$
5	$A \neq B$	
6	$AND(A, \bar{B})$	
7	$OR(A, \bar{B})$	
8	-	On

Note:

- When you use the function to output logical calculation results, you cannot set H2-01 to H2-03 = 1xx [Inverse Output of xx]. If you do, the drive will detect oPE33 [Digital Output Selection Error].
- When you do not use H2-60, H2-63, and H2-66, set them to F. The through mode function is not supported.

◆ H2 MFDO Parameters

■ H2-01: Term M1-M2 Function Selection

No. (Hex.)	Name	Description	Default (Range)
H2-01 (040B)	Term M1-M2 Function Selection	<input type="checkbox"/> V/f <input type="checkbox"/> CL-V/f <input type="checkbox"/> OLV <input type="checkbox"/> CLV <input type="checkbox"/> AOLV <input type="checkbox"/> QLV/PM <input type="checkbox"/> AOLV/PM <input type="checkbox"/> CLV/PM <input type="checkbox"/> EZOLV Sets the function for MFDO terminal M1-M2.	0 (0 - 1FF)

Note:

Set this parameter to F when the terminal is not being used or to use the terminal in through mode.

■ H2-02: Term M3-M4 Function Selection

No. (Hex.)	Name	Description	Default (Range)
H2-02 (040C)	Term M3-M4 Function Selection	<input type="checkbox"/> V/f <input type="checkbox"/> CL-V/f <input type="checkbox"/> OLV <input type="checkbox"/> CLV <input type="checkbox"/> AOLV <input type="checkbox"/> QLV/PM <input type="checkbox"/> AOLV/PM <input type="checkbox"/> CLV/PM <input type="checkbox"/> EZOLV Sets the function for MFDO terminal M3-M4.	1 (0 - 1FF)

Note:

Set this parameter to F when not using the terminal or to use the terminal in through mode.

■ H2-03: Term M5-M6 Function Selection

No. (Hex.)	Name	Description	Default (Range)
H2-03 (040D)	Term M5-M6 Function Selection	<input type="checkbox"/> V/f <input type="checkbox"/> CL-V/f <input type="checkbox"/> OLV <input type="checkbox"/> CLV <input type="checkbox"/> AOLV <input type="checkbox"/> QLV/PM <input type="checkbox"/> AOLV/PM <input type="checkbox"/> CLV/PM <input type="checkbox"/> EZOLV Sets the function for MFDO terminal M5-M6.	2 (0 - 1FF)

Note:

Set this parameter to F when not using the terminal or to use the terminal in through mode.

■ H2-06: Watt Hour Output Unit Selection

No. (Hex.)	Name	Description	Default (Range)
H2-06 (0437)	Watt Hour Output Unit Selection	V/f CL-V/f OLV CLV AOLV OLV/PM AOLV/PM CLV/PM EZOLV Sets the unit for the output signal when H2-01 to H2-03 = 39 [MFDO Function Selection = Watt Hour Pulse Output].	0 (0 - 4)

This output is input to the Watt hour meter or PLC through a 200 ms pulse signal. This parameter sets the kWh unit for each pulse output.

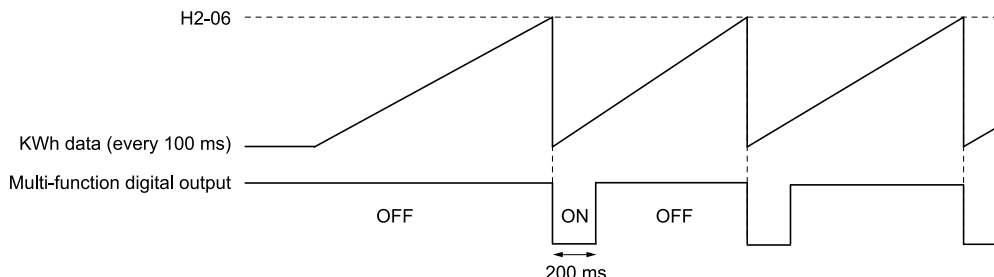

Figure 12.88 Example MFDO when Configured for Watt Hours

Note:

- When the power value is a negative value (regenerative state), the drive does not count Watt hours.
- When the control power supply to the drive is operating, the drive will keep the Watt hours. If a momentary power loss causes the drive to lose control power, the Watt hour count will reset.

0 : 0.1 kWh units

1 : 1 kWh units

2 : 10 kWh units

3 : 100 kWh units

4 : 1000 kWh units

■ H2-07: Modbus Register 1 Address Select

No. (Hex.)	Name	Description	Default (Range)
H2-07 (0B3A)	Modbus Register 1 Address Select	V/f CL-V/f OLV CLV AOLV OLV/PM AOLV/PM CLV/PM EZOLV Sets the address of the MEMOBUS/Modbus register output to the MFDO terminal.	0001 (0001 - 1FFF)

Sets the address of the register that is output to *Modbus Reg 1 Status Satisfied* [H2-01 to H2-03 = 62] and uses the bit in H2-08 [Modbus Register 1 Bit Select].

■ H2-08: Modbus Register 1 Bit Select

No. (Hex.)	Name	Description	Default (Range)
H2-08 (0B3B)	Modbus Register 1 Bit Select	V/f CL-V/f OLV CLV AOLV OLV/PM AOLV/PM CLV/PM EZOLV Sets the bit of the MEMOBUS/Modbus register output to the MFDO terminal.	0000 (0000 - FFFF)

Sets the bit of the register that is output to *Modbus Reg 1 Status Satisfied* [H2-01 to H2-03 = 62] and uses the address in H2-07 [Modbus Register 1 Address Select].

■ H2-09: Modbus Register 2 Address Select

No. (Hex.)	Name	Description	Default (Range)
H2-09 (0B3C)	Modbus Register 2 Address Select	V/f CL-V/f OLV CLV AOLV OLV/PM AOLV/PM CLV/PM EZOLV Sets the address of the MEMOBUS/Modbus register output to the MFDO terminal.	0001 (0001 - 1FFF)

Sets H2-09 with the address of the register that is output to *Modbus Reg 2 Status Satisfied* [H2-01 to H2-03 = 63] and uses the bit in H2-10 [Modbus Register 2 Bit Select].

■ H2-10: Modbus Register 2 Bit Select

No. (Hex.)	Name	Description	Default (Range)
H2-10 (0B3D)	Modbus Register 2 Bit Select	<div style="display: flex; justify-content: space-between; align-items: center;"> V/f CL-V/f OLV CLV AOLV OLV/PM AOLV/PM CLV/PM EZOLV </div> Sets the bit of the MEMOBUS/Modbus register output to the MFDO terminal.	0000 (0000 - FFFF)

Sets the bit of the register that is output to *Modbus Reg 2 Status Satisfied* [H2-01 to H2-03 = 63] and uses the address in H2-09.

■ H2-20: Comparator 1 Monitor Selection

No. (Hex.)	Name	Description	Default (Range)
H2-20 (1540)	Comparator 1 Monitor Selection	<div style="display: flex; justify-content: space-between; align-items: center;"> V/f CL-V/f OLV CLV AOLV OLV/PM AOLV/PM CLV/PM EZOLV </div> Sets the monitor number for comparator 1. Set the x-xx part of the <i>Ux-xx</i> [Monitor]. For example, set H2-20 = 102 to monitor U1-02 [Output Frequency].	102 (000 - 999)

Note:

- For information on the comparator function, refer to [66: Comparator1 on page 869](#) and [67: Comparator2 on page 869](#).
- The configurable monitor changes when the control method changes.

■ H2-21: Comparator 1 Lower Limit

No. (Hex.)	Name	Description	Default (Range)
H2-21 (1541)	Comparator 1 Lower Limit	<div style="display: flex; justify-content: space-between; align-items: center;"> V/f CL-V/f OLV CLV AOLV OLV/PM AOLV/PM CLV/PM EZOLV </div> Sets the lower limit detection level for comparator 1 when the full scale analog output for the monitor selected in H2-20 [Comparator 1 Monitor Selection] is the 100% value.	0.0% (0.0 - 300.0%)

Note:

For information on the comparator function, refer to [66: Comparator1 on page 869](#) and [67: Comparator2 on page 869](#).

■ H2-22: Comparator 1 Upper Limit

No. (Hex.)	Name	Description	Default (Range)
H2-22 (1542)	Comparator 1 Upper Limit	<div style="display: flex; justify-content: space-between; align-items: center;"> V/f CL-V/f OLV CLV AOLV OLV/PM AOLV/PM CLV/PM EZOLV </div> Sets the upper limit detection level for comparator 1 when the full scale analog output for the monitor selected in H2-20 [Comparator 1 Monitor Selection] is the 100% value.	0.0% (0.0 - 300.0%)

Note:

For information on the comparator function, refer to [66: Comparator1 on page 869](#) and [67: Comparator2 on page 869](#).

■ H2-23: Comparator 1 Hysteresis

No. (Hex.)	Name	Description	Default (Range)
H2-23 (1543)	Comparator 1 Hysteresis	<div style="display: flex; justify-content: space-between; align-items: center;"> V/f CL-V/f OLV CLV AOLV OLV/PM AOLV/PM CLV/PM EZOLV </div> Sets the hysteresis level for comparator 1 as a percentage of the full scale analog output for the monitor selected in H2-20 [Comparator 1 Monitor Selection].	0.0% (0.0 - 10.0%)

Note:

For information on the comparator function, refer to [66: Comparator1 on page 869](#) and [67: Comparator2 on page 869](#).

■ H2-24: Comparator 1 On-Delay Time

No. (Hex.)	Name	Description	Default (Range)
H2-24 (1544)	Comparator 1 On-Delay Time	<div style="display: flex; justify-content: space-between; align-items: center;"> V/f CL-V/f OLV CLV AOLV OLV/PM AOLV/PM CLV/PM EZOLV </div> Sets the on-delay time for comparator 1.	0.0 s (0.0 - 600.0 s)

Note:

For information on the comparator function, refer to [66: Comparator1 on page 869](#) and [67: Comparator2 on page 869](#).

■ H2-25: Comparator 1 Off-Delay Time

No. (Hex.)	Name	Description	Default (Range)
H2-25 (1545)	Comparator 1 Off-Delay Time	<div style="display: flex; justify-content: space-between; align-items: center;"> V/f CL-V/f OLV CLV AOLV OLV/PM AOLV/PM CLV/PM EZOLV </div> Sets the off-delay time for comparator 1.	0.0 s (0.0 - 600.0 s)

Note:

For information on the comparator function, refer to [66: Comparator1 on page 869](#) and [67: Comparator2 on page 869](#).

■ H2-26: Comparator 2 Monitor Selection

No. (Hex.)	Name	Description	Default (Range)
H2-26 (1546)	Comparator 2 Monitor Selection	<div style="display: flex; justify-content: space-between; align-items: center;"> V/f CL-V/f OLV CLV AOLV OLV/PM AOLV/PM CLV/PM EZOLV </div> Sets the monitor number for comparator 2. Set the x-xx part of the Ux-xx [Monitor]. For example, set H2-26 = 103 to monitor U1-03 [Output Current].	103 (000 - 999)

Note:

- The configurable monitor changes when the control method changes.
- When you use the terminal in through mode, set this parameter to 000 or 031. You can set the terminal output level from the PLC through MEMOBUS/Modbus communications or the communication option.
- For information on the comparator function, refer to [66: Comparator1 on page 869](#) and [67: Comparator2 on page 869](#).

■ H2-27: Comparator 2 Lower Limit

No. (Hex.)	Name	Description	Default (Range)
H2-27 (1547)	Comparator 2 Lower Limit	<div style="display: flex; justify-content: space-between; align-items: center;"> V/f CL-V/f OLV CLV AOLV OLV/PM AOLV/PM CLV/PM EZOLV </div> Sets the lower limit detection level for comparator 2 as a percentage of the full scale analog output for the monitor selected in H2-26 [Comparator 2 Monitor Selection].	0.0% (0.0 - 300.0%)

Note:

For information on the comparator function, refer to [66: Comparator1 on page 869](#) and [67: Comparator2 on page 869](#).

■ H2-28: Comparator 2 Upper Limit

No. (Hex.)	Name	Description	Default (Range)
H2-28 (1548)	Comparator 2 Upper Limit	<div style="display: flex; justify-content: space-between; align-items: center;"> V/f CL-V/f OLV CLV AOLV OLV/PM AOLV/PM CLV/PM EZOLV </div> Sets the upper limit detection level for comparator 2 as a percentage of the full scale analog output for the monitor selected in H2-26 [Comparator 2 Monitor Selection].	0.0% (0.0 - 300.0%)

Note:

For information on the comparator function, refer to [66: Comparator1 on page 869](#) and [67: Comparator2 on page 869](#).

■ H2-29: Comparator 2 Hysteresis

No. (Hex.)	Name	Description	Default (Range)
H2-29 (1549)	Comparator 2 Hysteresis	<div style="display: flex; justify-content: space-between; align-items: center;"> V/f CL-V/f OLV CLV AOLV OLV/PM AOLV/PM CLV/PM EZOLV </div> Sets the hysteresis level for comparator 2 as a percentage of the full scale analog output for the monitor selected in H2-26 [Comparator 2 Monitor Selection].	0.0% (0.0 - 10.0%)

Note:

For information on the comparator function, refer to [66: Comparator1 on page 869](#) and [67: Comparator2 on page 869](#).

■ H2-30: Comparator 2 On-Delay Time

No. (Hex.)	Name	Description	Default (Range)
H2-30 (154A)	Comparator 2 On-Delay Time	<div style="display: flex; justify-content: space-between; align-items: center;"> V/f CL-V/f OLV CLV AOLV OLV/PM AOLV/PM CLV/PM EZOLV </div> Sets the on-delay time for comparator 2.	0.0 s (0.0 - 600.0 s)

Note:

For information on the comparator function, refer to [66: Comparator1 on page 869](#) and [67: Comparator2 on page 869](#).

■ H2-31: Comparator 2 Off-Delay Time

No. (Hex.)	Name	Description	Default (Range)
H2-31 (154B)	Comparator 2 Off-Delay Time	V/f CL-V/f OLV CLV AOLV OLV/PM AOLV/PM CLV/PM EZOLV Sets the off-delay time for comparator 2.	0.0 s (0.0 - 600.0 s)

Note:

For information on the comparator function, refer to [66: Comparator1 on page 869](#) and [67: Comparator2 on page 869](#).

■ H2-32: Comparator 1 Filter Time

No. (Hex.)	Name	Description	Default (Range)
H2-32 (159A)	Comparator 1 Filter Time	V/f CL-V/f OLV CLV AOLV OLV/PM AOLV/PM CLV/PM EZOLV Sets the time constant that is applied to the primary delay filter used for the analog output of the monitor selected with <i>H2-20</i> [Comparator 1 Monitor Selection].	0.0s (0.0 - 10.0 s)

Note:

For information on the comparator function, refer to [66: Comparator1 on page 869](#) and [67: Comparator2 on page 869](#).

■ H2-33: Comparator1 Protection Selection

No. (Hex.)	Name	Description	Default (Range)
H2-33 (159B)	Comparator1 Protection Selection	V/f CL-V/f OLV CLV AOLV OLV/PM AOLV/PM CLV/PM EZOLV Sets drive operation when it detects <i>CP1</i> [Comparator1 Limit Fault].	4 (0 - 4)

0 : Ramp to Stop

The drive ramps the motor to stop in the deceleration time. Fault relay output terminal MA-MC turns ON, and MB-MC turns OFF.

1 : Coast to Stop

The output turns off and the motor coasts to stop. Fault relay output terminal MA-MC turns ON, and MB-MC turns OFF.

2 : Fast Stop (Use C1-09)

The drive stops the motor in the deceleration time set in *C1-09* [Fast Stop Time]. Fault relay output terminal MA-MC turns ON, and MB-MC turns OFF.

3 : Alarm Only

The keypad shows *CP1* and the drive continues operation at the current frequency reference.

Note:

The output terminal set for *Alarm* [*H2-01 to H2-03 = 10*] activates.

4 : Digital Output Only

■ H2-34: Comparator 2 Filter Time

No. (Hex.)	Name	Description	Default (Range)
H2-34 (159C)	Comparator 2 Filter Time	V/f CL-V/f OLV CLV AOLV OLV/PM AOLV/PM CLV/PM EZOLV Sets the time constant that is applied to the primary delay filter used for the analog output of the monitor selected with <i>H2-26</i> [Comparator 2 Monitor Selection].	0.0s (0.0 - 10.0 s)

■ H2-35: Comparator2 Protection Selection

No. (Hex.)	Name	Description	Default (Range)
H2-35 (159D)	Comparator2 Protection Selection	V/f CL-V/f OLV CLV AOLV OLV/PM AOLV/PM CLV/PM EZOLV Sets drive operation when it detects <i>CP2</i> [Comparator2 Limit Fault].	4 (0 - 4)

0 : Ramp to Stop

The drive ramps the motor to stop in the deceleration time. Fault relay output terminal MA-MC turns ON, and MB-MC turns OFF.

1 : Coast to Stop

The output turns off and the motor coasts to stop. Fault relay output terminal MA-MC turns ON, and MB-MC turns OFF.

2 : Fast Stop (Use C1-09)

The drive stops the motor in the deceleration time set in *C1-09 [Fast Stop Time]*. Fault relay output terminal MA-MC turns ON, and MB-MC turns OFF.

3 : Alarm Only

The keypad shows *CP2* and the drive continues operation at the current frequency reference.

Note:

The output terminal set for *Alarm [H2-01 to H2-03 = 10]* activates.

4 : Digital Output Only

■ H2-36: Comparator 1 Ineffective Time

No. (Hex.)	Name	Description	Default (Range)
H2-36 (159E)	Comparator 1 Ineffective Time	<div style="display: flex; justify-content: space-between; align-items: center;"> V/f CL-V/f OLV CLV AOLV OLV/PM AOLV/PM CLV/PM EZOLV </div> Sets the length of time that <i>CP1 [Comparator1 Limit Fault]</i> is disabled.	0.0 s (0.0 - 1000.0 s)

Note:

- After you enter a Run command and wait for the time set in this parameter, the drive will monitor operation and make sure that it is in the Comparator 1 range until you enter the Stop command.
- When *CP1* detection is disabled, the drive will activate the output terminal set for *Comparator 1 [H2-xx = 66]*.

■ H2-37: Comparator 2 Ineffective Time

No. (Hex.)	Name	Description	Default (Range)
H2-37 (159F)	Comparator 2 Ineffective Time	<div style="display: flex; justify-content: space-between; align-items: center;"> V/f CL-V/f OLV CLV AOLV OLV/PM AOLV/PM CLV/PM EZOLV </div> Sets the length of time that <i>CP2 [Comparator2 Limit Fault]</i> is disabled.	0.0 s (0.0 - 1000.0 s)

Note:

- After you enter a Run command and wait for the time set in this parameter, the drive will monitor operation and make sure that it is in the Comparator 2 range until you enter the Stop command.
- When *CP2* detection is disabled, the drive will activate the output terminal set for *Comparator 2 [H2-xx = 67]*.

■ H2-40: Mbus Reg 15E0h bit0 Output Func

No. (Hex.)	Name	Description	Default (Range)
H2-40 (0B58)	Mbus Reg 15E0h bit0 Output Func	<div style="display: flex; justify-content: space-between; align-items: center;"> V/f CL-V/f OLV CLV AOLV OLV/PM AOLV/PM CLV/PM EZOLV </div> Sets the MFDO for bit 0 of MEMOBUS register 15E0 (Hex.).	F (0 - 1FF)

■ H2-41: Mbus Reg 15E0h bit1 Output Func

No. (Hex.)	Name	Description	Default (Range)
H2-41 (0B59)	Mbus Reg 15E0h bit1 Output Func	<div style="display: flex; justify-content: space-between; align-items: center;"> V/f CL-V/f OLV CLV AOLV OLV/PM AOLV/PM CLV/PM EZOLV </div> Sets the MFDO for bit 1 of MEMOBUS register 15E0 (Hex.).	F (0 - 1FF)

■ H2-42: Mbus Reg 15E0h bit2 Output Func

No. (Hex.)	Name	Description	Default (Range)
H2-42 (0B5A)	Mbus Reg 15E0h bit2 Output Func	<div style="display: flex; justify-content: space-between; align-items: center;"> V/f CL-V/f OLV CLV AOLV OLV/PM AOLV/PM CLV/PM EZOLV </div> Sets the MFDO for bit 2 of MEMOBUS register 15E0 (Hex.).	F (0 - 1FF)

■ H2-60: Term M1-M2 Secondary Function

No. (Hex.)	Name	Description	Default (Range)
H2-60 (1B46) Expert	Term M1-M2 Secondary Function	<div style="display: flex; justify-content: space-between; gap: 5px;"> V/f CL-V/f OLV CLV AOLV OLV/PM AOLV/PM CLV/PM EZOLV </div> Sets the second function for terminal M1-M2. Outputs the logical calculation results of the terminals assigned to functions by H2-01 [Term M1-M2 Function Selection].	F (0 - FF)

■ H2-61: Terminal M1-M2 Logical Operation

No. (Hex.)	Name	Description	Default (Range)
H2-61 (1B47) Expert	Terminal M1-M2 Logical Operation	<div style="display: flex; justify-content: space-between; gap: 5px;"> V/f CL-V/f OLV CLV AOLV OLV/PM AOLV/PM CLV/PM EZOLV </div> Sets the logical operation for the functions set in H2-01 [Term M1-M2 Function Selection] and H2-60 [Term M1-M2 Secondary Function].	0 (0 - 8)

Note:

Refer to [Output of Logical Operation Results of MFDO on page 847](#) for more information about the relation between parameter settings and logical operations.

■ H2-62: Terminal M1-M2 Delay Time

No. (Hex.)	Name	Description	Default (Range)
H2-62 (1B48) Expert	Terminal M1-M2 Delay Time	<div style="display: flex; justify-content: space-between; gap: 5px;"> V/f CL-V/f OLV CLV AOLV OLV/PM AOLV/PM CLV/PM EZOLV </div> Sets the minimum on time used to output the logical calculation results from terminal M1-M2.	0.1 s (0.0 - 25.0 s)

■ H2-63: Term M3-M4 Secondary Function

No. (Hex.)	Name	Description	Default (Range)
H2-63 (1B49) Expert	Term M3-M4 Secondary Function	<div style="display: flex; justify-content: space-between; gap: 5px;"> V/f CL-V/f OLV CLV AOLV OLV/PM AOLV/PM CLV/PM EZOLV </div> Sets the second function for terminal M3-M4. Outputs the logical calculation results of the terminals assigned to functions by H2-02 [Term M3-M4 Function Selection].	F (0 - FF)

■ H2-64: Terminal M3-M4 Logical Operation

No. (Hex.)	Name	Description	Default (Range)
H2-64 (1B4A) Expert	Terminal M3-M4 Logical Operation	<div style="display: flex; justify-content: space-between; gap: 5px;"> V/f CL-V/f OLV CLV AOLV OLV/PM AOLV/PM CLV/PM EZOLV </div> Sets the logical operation for the functions set in H2-02 [Term M3-M4 Function Selection] and H2-63 [Term M3-M4 Secondary Function].	0 (0 - 8)

Note:

Refer to [Output of Logical Operation Results of MFDO on page 847](#) for more information about the relation between parameter settings and logical operations.

■ H2-65: Terminal M3-M4 Delay Time

No. (Hex.)	Name	Description	Default (Range)
H2-65 (1B4B) Expert	Terminal M3-M4 Delay Time	<div style="display: flex; justify-content: space-between; gap: 5px;"> V/f CL-V/f OLV CLV AOLV OLV/PM AOLV/PM CLV/PM EZOLV </div> Sets the minimum on time used to output the logical calculation results from terminal M3-M4.	0.1 s (0.0 - 25.0 s)

■ H2-66: Term M5-M6 Secondary Function

No. (Hex.)	Name	Description	Default (Range)
H2-66 (1B4C) Expert	Term M5-M6 Secondary Function	<div style="display: flex; justify-content: space-between; gap: 5px;"> V/f CL-V/f OLV CLV AOLV OLV/PM AOLV/PM CLV/PM EZOLV </div> Sets the second function for terminal M5-M6. Outputs the logical calculation results of the terminals assigned to functions by H2-03 [Terminal M5-M6 Function Select].	F (0 - FF)

■ H2-67: Terminal M5-M6 Logical Operation

No. (Hex.)	Name	Description	Default (Range)
H2-67 (1B4D) Expert	Terminal M5-M6 Logical Operation	<div style="display: flex; justify-content: space-between; font-size: small;"> V/f CL-V/f OLV CLV AOLV OLV/PM AOLV/PM CLV/PM EZOLV </div> <p>Sets the logical operation for the functions set in H2-03 [Term M5-M6 Function Selection] and H2-66 [Term M5-M6 Secondary Function].</p>	0 (0 - 8)

Note:

Refer to [Output of Logical Operation Results of MFDO on page 847](#) for more information about the relation between parameter settings and logical operations.

■ H2-68: Terminal M5-M6 Delay Time

No. (Hex.)	Name	Description	Default (Range)
H2-68 (1B4E) Expert	Terminal M5-M6 Delay Time	<div style="display: flex; justify-content: space-between; font-size: small;"> V/f CL-V/f OLV CLV AOLV OLV/PM AOLV/PM CLV/PM EZOLV </div> <p>Sets the minimum on time used to output the logical calculation results from terminal M5-M6.</p>	0.1 s (0.0 - 25.0 s)

◆ MFDO Setting Value

Selects the function configured to a MFDO.

■ 0: During Run

Setting Value	Function	Description
0	During Run	<div style="display: flex; justify-content: space-between; font-size: small;"> V/f CL-V/f OLV CLV AOLV OLV/PM AOLV/PM CLV/PM EZOLV </div> <p>The terminal activates when the Run command is input and when the drive is outputting voltage.</p>

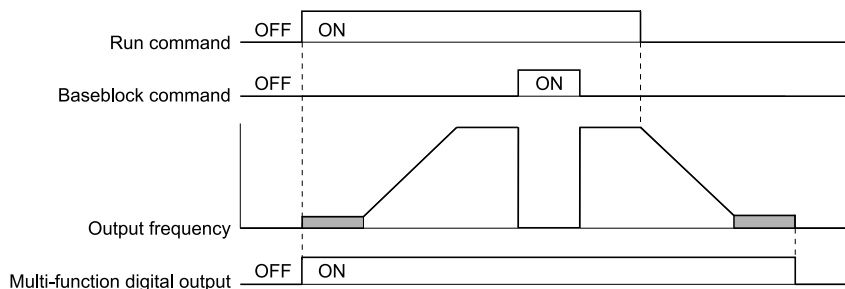

Figure 12.89 Drive Running Time Chart

ON : Drive is running

The drive is receiving a Run command or outputting voltage.

OFF : Drive is stopping

Drive is stopped.

■ 1: Zero Speed

Setting Value	Function	Description
1	Zero Speed	<div style="display: flex; justify-content: space-between; font-size: small;"> V/f CL-V/f OLV CLV AOLV OLV/PM AOLV/PM CLV/PM EZOLV </div> <p>The terminal activates when the output frequency < E1-09 [Minimum Output Frequency] or b2-01 [DC Injection/Zero SpeedThreshold].</p>

Note:

Parameter *A1-02* [Control Method Selection] selects which parameter is the reference.

A1-02 Setting	Control method selection	Parameter Used as the Reference
0	V/f Control	<i>E1-09</i>
1	V/f Control with Encoder	<i>E1-09</i>
2	Open Loop Vector	<i>b2-01</i>
3	Closed Loop Vector	<i>E1-09</i>
4	Advanced OpenLoop Vector Control	<i>E1-09</i>
5	PM Open Loop Vector	<i>E1-09</i>
6	PM Advanced Open Loop Vector	<i>E1-09</i>
7	PM Closed Loop Vector Control	<i>b2-01</i>
8	EZ Open Loop Vector Control	<i>E1-09</i>

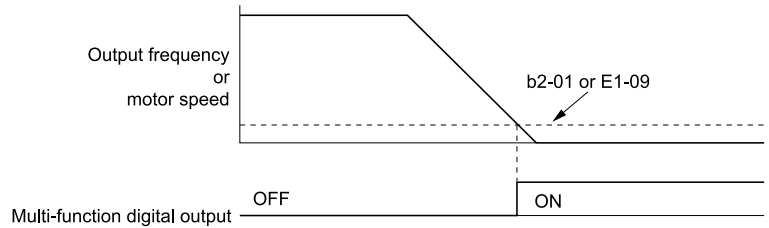

Figure 12.90 Zero Speed Time Chart

ON : Output frequency < value of *E1-09* or *b2-01*.

OFF : Output frequency ≥ value of *E1-09* or *b2-01*.

■ 2: Speed Agree 1

Setting Value	Function	Description
2	Speed Agree 1	<div style="border: 1px solid black; padding: 2px; display: inline-block;"> V/f CL-V/f OLV CLV AQLV QLV/PM AQLV/PM CLV/PM EZOLV </div> The terminal turns on when the output frequency is in the range of the frequency reference ± <i>L4-02</i> [Speed Agree Detection Width].

Note:

- The detection function operates in the two motor rotation directions.
- The drive outputs the motor speed status when *A1-02* = 3, 7 [CLV, CLV/PM]. It also outputs the motor speed status when *A1-02* = 4 and *n4-72* = 1.

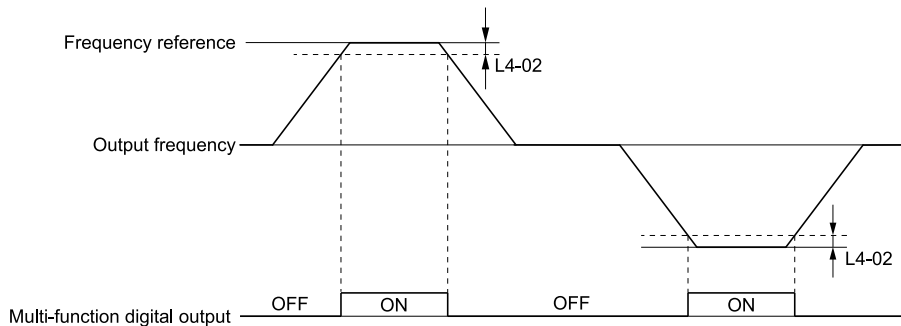

Figure 12.91 Speed Agree 1 Time Chart

ON : The output frequency is in the range of “frequency reference ± *L4-02*”.

OFF : The output frequency does not align with the frequency reference although the drive is running.

3: User-Set Speed Agree 1

Setting Value	Function	Description
3	User-Set Speed Agree 1	<p>V/f CL-V/f OLV CLV AOLV OLV/PM AOLV/PM CLV/PM EZOLV</p> <p>The terminal activates when the output frequency is in the range of $L4-01$ [Speed Agree Detection Level] \pm $L4-02$ [Speed Agree Detection Width] and in the range of the frequency reference \pm $L4-02$.</p>

Note:

- The detection function operates in the two motor rotation directions. The drive uses the $L4-01$ value as the forward/reverse detection level.
- The drive outputs the motor speed status when $A1-02 = 3, 7$ [CLV, CLV/PM]. It also outputs the motor speed status when $A1-02 = 4$ and $n4-72 = 1$.

ON : The output frequency is in the range of “ $L4-01 \pm L4-02$ ” and the range of frequency reference $\pm L4-02$.

OFF : The output frequency is not in the range of “ $L4-01 \pm L4-02$ ” or the range of frequency reference $\pm L4-02$.

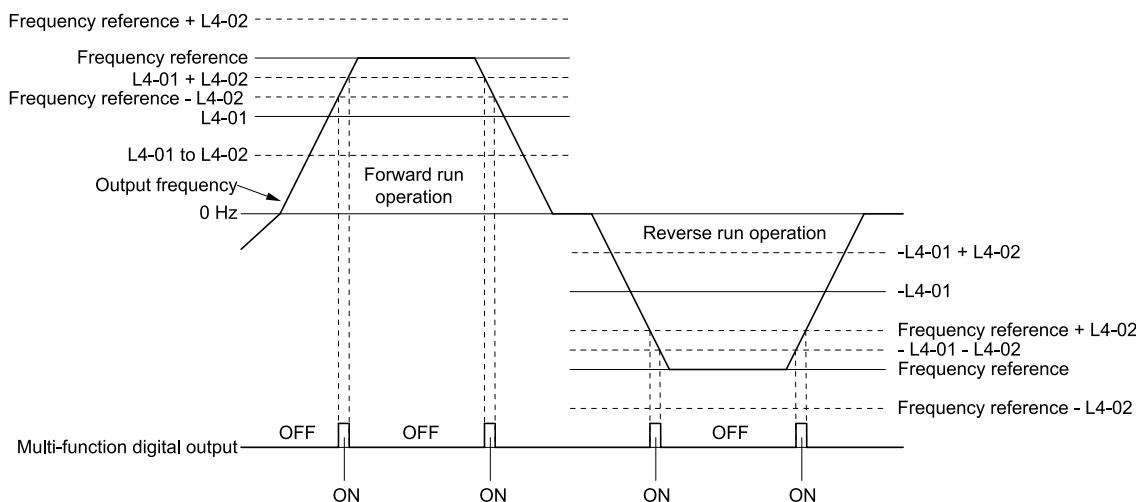

Figure 12.92 User-Defined Speed Agree 1 Time Chart

4: Frequency Detection 1

Setting Value	Function	Description
4	Frequency Detection 1	<p>V/f CL-V/f OLV CLV AOLV OLV/PM AOLV/PM CLV/PM EZOLV</p> <p>The terminal deactivates when the output frequency $> L4-01$ [Speed Agree Detection Level] + $L4-02$ [Speed Agree Detection Width]. After the terminal turns off, the terminal continues to remain off until the output frequency reaches the level set with $L4-01$.</p>

Note:

- The detection function operates in the two motor rotation directions. The drive uses the $L4-01$ value as the forward/reverse detection level.
- The drive outputs the motor speed status when $A1-02 = 3, 7$ [CLV, CLV/PM]. It also outputs the motor speed status when $A1-02 = 4$ and $n4-72 = 1$.

ON : The output frequency is less than the value of $L4-01$ or does not exceed the value of $L4-01 + L4-02$.

OFF : The output frequency $> L4-01 + L4-02$.

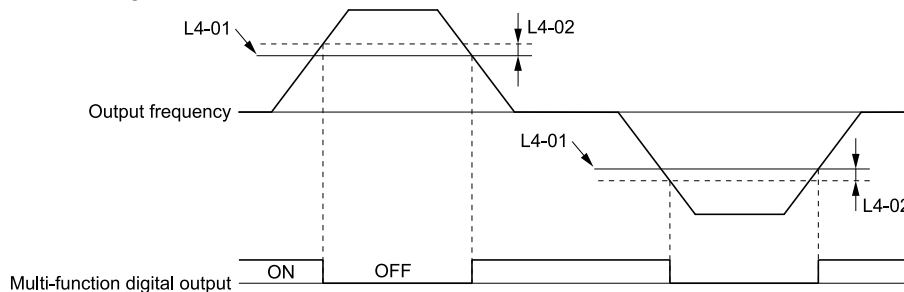

Figure 12.93 Frequency Detection 1 Time Chart

Note:

Figure 12.93 shows the result of the configuration when $L4-07 = 1$ [Speed Agree Detection Selection = Detection Always Enabled]. The default setting of $L4-07$ is 0 [No detection during baseblock]. When the speed agreement detection selection is “No Detection during Baseblock”, the terminal is deactivated when the drive output stops.

5: Frequency Detection 2

Setting Value	Function	Description
5	Frequency Detection 2	<div style="display: flex; justify-content: space-between; font-size: small;"> V/f CL-V/f OLV CLV AOLV OLV/PM AOLV/PM CLV/PM EZOLV </div> <p>The terminal activates when the output frequency is higher than the value of $L4-01$ [Speed Agree Detection Level]. After the terminal activates, the terminal stays activated until the output frequency = $L4-01 - L4-02$.</p>

Note:

- The detection function operates in the two motor rotation directions. The drive uses the $L4-01$ value as the forward/reverse detection level.
- The drive outputs the motor speed status when $A1-02 = 3, 7$ [CLV, CLV/PM]. It also outputs the motor speed status when $A1-02 = 4$ and $n4-72 = 1$.

ON : The output frequency is higher than the value of $L4-01$.

OFF : The output frequency < “ $L4-01 - L4-02$ ”, or $\leq L4-01$.

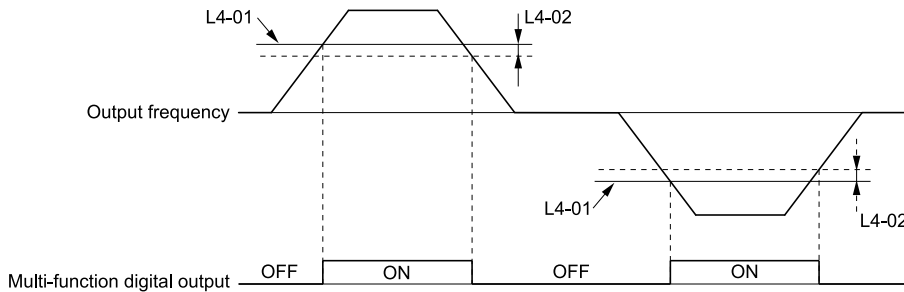

Figure 12.94 Frequency Detection 2 Time Chart

6: Drive ready

Setting Value	Function	Description
6	Drive ready	<div style="display: flex; justify-content: space-between; font-size: small;"> V/f CL-V/f OLV CLV AOLV OLV/PM AOLV/PM CLV/PM EZOLV </div> <p>The terminal activates when the drive is ready and running.</p>

The terminal deactivates in these conditions:

- When the power supply is OFF
- During a fault
- When there is problem with the control power supply
- When there is a parameter configuration error and the drive cannot operate although there is a Run command
- When you enter a Run command and it immediately triggers an overvoltage or undervoltage fault because the drive has an overvoltage or undervoltage fault during stop
- When the drive is in Programming Mode and will not accept a Run command

7: DC Bus Undervoltage

Setting Value	Function	Description
7	DC Bus Undervoltage	<div style="display: flex; justify-content: space-between; font-size: small;"> V/f CL-V/f OLV CLV AOLV OLV/PM AOLV/PM CLV/PM EZOLV </div> <p>The terminal activates when the DC bus voltage or control circuit power supply is less than the voltage set with $L2-05$ [Undervoltage Detection Lvl (Uv1)]. The terminal also turns on when there is a fault with the DC bus voltage.</p>

ON : The DC bus voltage is less than the setting value of $L2-05$.

OFF : The DC bus voltage is more than the setting value of $L2-05$.

■ 8: During Baseblock (N.O.)

Setting Value	Function	Description
8	During Baseblock (N.O.)	<div style="display: flex; justify-content: space-between; align-items: center;"> V/f CL-V/f OLV CLV AOLV OLV/PM AOLV/PM CLV/PM EZOLV </div> <p>The terminal turns on during baseblock. When the drive is in baseblock, the drive output transistor stops switching and does not make DC bus voltage.</p>

ON : During baseblock

OFF : The drive is not in baseblock.

■ 9: Frequency Reference from Keypad

Setting Value	Function	Description
9	Frequency Reference from Keypad	<div style="display: flex; justify-content: space-between; align-items: center;"> V/f CL-V/f OLV CLV AOLV OLV/PM AOLV/PM CLV/PM EZOLV </div> <p>Shows the selected frequency reference source.</p>

ON : The keypad is the frequency reference source.

OFF : *b1-01* or *b1-15* [*Frequency Reference Selection 1* or *2*] is the frequency reference source.

■ A: Run Command from Keypad

Setting Value	Function	Description
A	Run Command Source	<div style="display: flex; justify-content: space-between; align-items: center;"> V/f CL-V/f OLV CLV AOLV OLV/PM AOLV/PM CLV/PM EZOLV </div> <p>Shows the selected Run command source.</p>

ON : The keypad is the Run command source.

OFF : *b1-02* or *b1-16* [*Run Command Selection 1* or *2*] is the Run command source.

■ B: Torque Detection 1 (N.O.)

Setting Value	Function	Description
B	Torque Detection 1 (N.O.)	<div style="display: flex; justify-content: space-between; align-items: center;"> V/f CL-V/f OLV CLV AOLV OLV/PM AOLV/PM CLV/PM EZOLV </div> <p>The terminal activates when the drive detects overtorque or undertorque.</p>

ON : The output current/torque is more than the torque value set with *L6-02* [*Torque Detection Level 1*], or the level is less than the torque value set with *L6-02* for longer than the time set with *L6-03* [*Torque Detection Time 1*].

Note:

- When *L6-01* ≥ 5 , the drive will detect when the output current/torque is less than the detection level of *L6-02* for longer than the time set in *L6-03*.
- Refer to “L6: Torque Detection” for more information.

■ C: Frequency Reference Loss

Setting Value	Function	Description
C	Frequency Reference Loss	<div style="display: flex; justify-content: space-between; align-items: center;"> V/f CL-V/f OLV CLV AOLV OLV/PM AOLV/PM CLV/PM EZOLV </div> <p>The terminal activates when the drive detects a loss of frequency reference.</p>

Note:

Refer to “L4-05: Fref Loss Detection Selection” for more information.

■ D: Braking Resistor Fault

Setting Value	Function	Description
D	Braking Resistor Fault	<div style="display: flex; justify-content: space-between; align-items: center;"> V/f CL-V/f OLV CLV AOLV OLV/PM AOLV/PM CLV/PM EZOLV </div> <p>The terminal activates when the mounting-type braking resistor is overheating or when there is a braking transistor fault.</p>

■ E: Fault

Setting Value	Function	Description
E	Fault	<div style="display: flex; justify-content: space-between; gap: 5px;"> V/f CL-V/f OLV CLV AOLV OLV/PM AOLV/PM CLV/PM EZOLV </div> <p>The terminal activates when the drive detects a fault.</p>

Note:

The terminal will not activate for *CPF00* and *CPF01* [Control Circuit Error] faults.

■ F: Not Used

Setting Value	Function	Description
F	Not Used	<div style="display: flex; justify-content: space-between; gap: 5px;"> V/f CL-V/f OLV CLV AOLV OLV/PM AOLV/PM CLV/PM EZOLV </div> <p>Use this setting for unused terminals or to use terminals in through mode. Also use this setting as the PLC contact output via MEMOBUS/Modbus or the communication option. This signal does not function if signals from the PLC are not configured.</p>

■ 10: Alarm

Setting Value	Function	Description
10	Alarm	<div style="display: flex; justify-content: space-between; gap: 5px;"> V/f CL-V/f OLV CLV AOLV OLV/PM AOLV/PM CLV/PM EZOLV </div> <p>The terminal turns on when the drive detects a minor fault.</p>

■ 11: Fault Reset Command Active

Setting Value	Function	Description
11	Fault Reset Command Active	<div style="display: flex; justify-content: space-between; gap: 5px;"> V/f CL-V/f OLV CLV AOLV OLV/PM AOLV/PM CLV/PM EZOLV </div> <p>The terminal turns on when the drive receives the Reset command from the control circuit terminal, serial communications, or the communication option.</p>

■ 12: Timer Output

Setting Value	Function	Description
12	Timer Output	<div style="display: flex; justify-content: space-between; gap: 5px;"> V/f CL-V/f OLV CLV AOLV OLV/PM AOLV/PM CLV/PM EZOLV </div> <p>Use this setting when the drive uses the timer function as an output terminal.</p>

Note:

Refer to “b4: Timer Function” for more information.

■ 13: Speed Agree 2

Setting Value	Function	Description
13	Speed Agree 2	<div style="display: flex; justify-content: space-between; gap: 5px;"> V/f CL-V/f OLV CLV AOLV OLV/PM AOLV/PM CLV/PM EZOLV </div> <p>The terminal activates when the output frequency is in the range of the frequency reference $\pm L4-04$ [Speed Agree Detection Width (+/-)].</p>

Note:

- The detection function operates in the two motor rotation directions.
- The drive outputs the motor speed status when $A1-02 = 3, 7$ [Control Method Selection = CLV, CLV/PM].

ON : The output frequency is in the range of “frequency reference $\pm L4-04$ ”.

OFF : The output frequency is not in the range of “frequency reference $\pm L4-04$ ”.

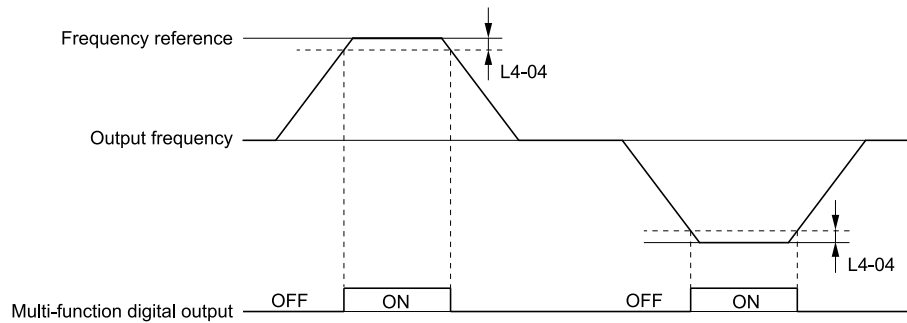

Figure 12.95 Speed Agree 2 Time Chart

■ 14: User-Set Speed Agree 2

Setting Value	Function	Description
14	User-Set Speed Agree 2	V/f CL-V/f OLV CLV AOLV OLV/PM AOLV/PM CLV/PM EZOLV The terminal activates when the output frequency is in the range of $L4-03$ [Speed Agree Detection Level (+/-)] \pm $L4-04$ [Speed Agree Detection Width (+/-)] and in the range of the frequency reference \pm $L4-04$.

Note:

- The detection level set in $L4-03$ is a signed value. The drive will only detect in one direction.
- The drive outputs the motor speed status when $A1-02 = 3, 7$ [Control Method Selection = CLV ; CLV/PM].

ON : The output frequency is in the range of “ $L4-03 \pm L4-04$ ” and the range of frequency reference \pm $L4-04$.

OFF : The output frequency is not in the range of “ $L4-03 \pm L4-04$ ” or the range of frequency reference \pm $L4-04$.

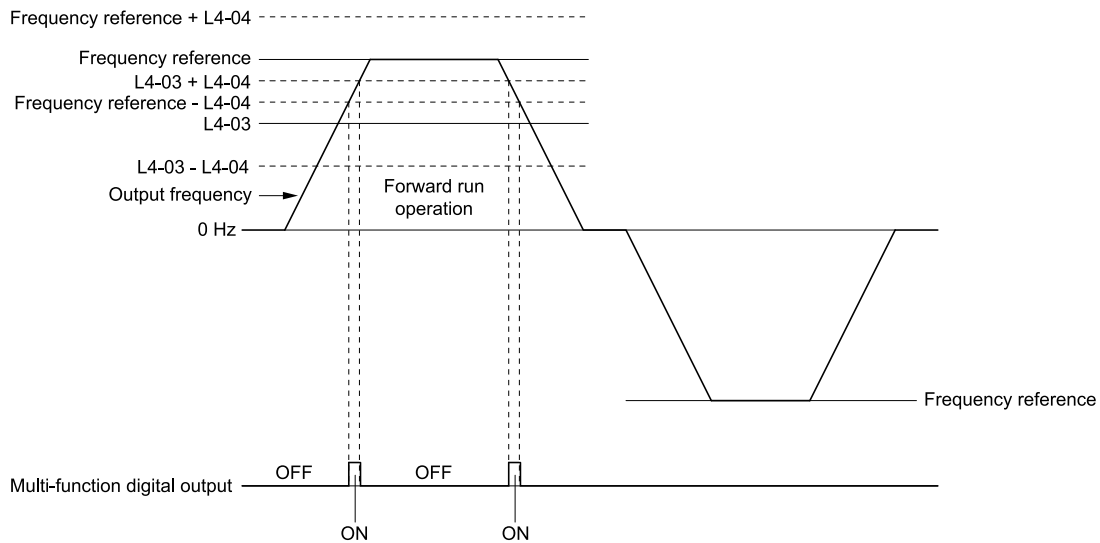

Figure 12.96 Example of User-set Speed Agree 2 (L4-03 Is Positive)

■ 15: Frequency Detection 3

Setting Value	Function	Description
15	Frequency Detection 3	V/f CL-V/f OLV CLV AOLV OLV/PM AOLV/PM CLV/PM EZOLV The terminal deactivates when the output frequency is higher than the value of “ $L4-03$ [Speed Agree Detection Level (+/-)] + $L4-04$ [Speed Agree Detection Width (+/-)]”. After the terminal deactivates, the terminal stays off until the output frequency is at the value of $L4-03$.

Note:

- The detection level set in $L4-03$ is a signed value. The drive will only detect in one direction.
- The drive outputs the motor speed status when $A1-02 = 3, 7$ [Control Method Selection = CLV ; CLV/PM].

ON : The output frequency is less than the value of $L4-03$ or is not higher than the value of $L4-03 + L4-04$.

OFF : The output frequency is higher than the value of $L4-03 + L4-04$.

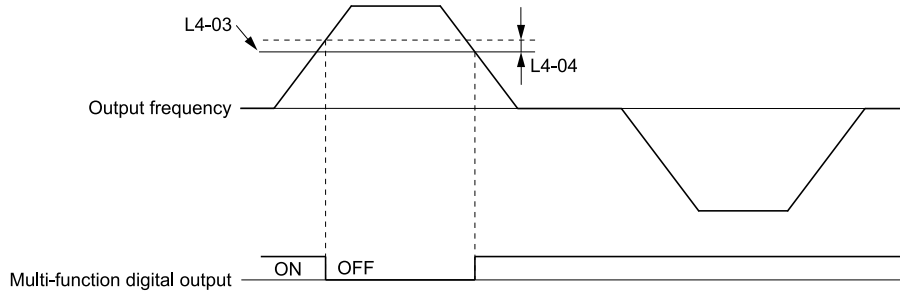

Figure 12.97 Example of Frequency Detection 3 (value of L4-03 Is Positive)

Note:

Figure 12.97 shows the time chart when $L4-07 = 1$ [Speed Agree Detection Selection = Detection Always Enabled]. The default setting of $L4-07$ is 0 [No detection during baseblock]. When the speed agreement detection selection is “No Detection during Baseblock”, the terminal is deactivated when the drive output stops.

■ 16: Frequency Detection 4

Setting Value	Function	Description
16	Frequency Detection 4	<div style="display: flex; justify-content: space-between; font-size: small;"> V/f CL-V/f OLV CLV AOLV OLV/PM AOLV/PM CLV/PM EZOLV </div> <p>The terminal activates when the output frequency is higher than the value of $L4-03$ [Speed Agree Detection Level (+/-)]. After the terminal activates, the terminal stays on until the output frequency is at the value of $L4-03 - L4-04$.</p>

Note:

- The detection level set in $L4-03$ is a signed value. The drive will only detect in one direction.
- The drive outputs the motor speed status if $A1-02 = 3, 7$ [Control Method Selection = CLV, CLV/PM].

ON : The output frequency is higher than the value of $L4-03$.

OFF : The output frequency is less than the value of “ $L4-03 - L4-04$ ”, or it is not higher than the value of $L4-03$.

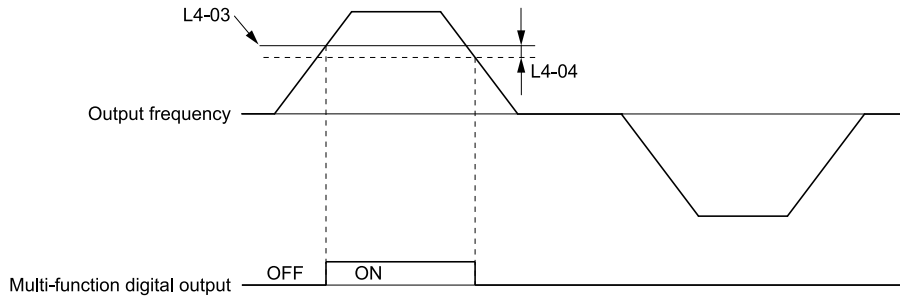

Figure 12.98 Example of Frequency Detection 4 (value of L4-03 Is Positive)

■ 17: Torque Detection 1 (N.C.)

Setting Value	Function	Description
17	Torque Detection 1 (N.C.)	<div style="display: flex; justify-content: space-between; font-size: small;"> V/f CL-V/f OLV CLV AOLV OLV/PM AOLV/PM CLV/PM EZOLV </div> <p>The terminal deactivates when the drive detects overtorque or undertorque.</p>

Use the $L6$ [Torque Detection] parameters to set torque detection.

OFF : The output current/torque is more than the torque value set with $L6-02$ [Torque Detection Level 1], or the level is less than the torque value set with $L6-02$ for longer than the time set with $L6-03$ [Torque Detection Time 1].

Note:

- When $L6-01 \geq 5$, the drive will detect when the output current/torque is less than the detection level of $L6-02$ for longer than the time set in $L6-03$.
- Refer to “L6: Torque Detection” for more information.

18: Torque Detection 2 (N.O.)

Setting Value	Function	Description
18	Torque Detection 2 (N.O.)	V/f CL-V/f OLV CLV AOLV OLV/PM AOLV/PM CLV/PM EZOLV The terminal activates when the drive detects overtorque or undertorque.

Use the *L6 [Torque Detection]* parameters to set torque detection.

ON : The output current/torque is more than the torque value set with *L6-05 [Torque Detection Level 2]*, or the level is less than the torque value set with *L6-05* for longer than the time set with *L6-06 [Torque Detection Time 2]*.

Note:

- When *L6-04* ≥ 5 , the drive will detect when the output current/torque is less than the detection level of *L6-05* for longer than the time set in *L6-06*.
- Refer to “L6: Torque Detection” for more information.

19: Torque Detection 2 (N.C.)

Setting Value	Function	Description
19	Torque Detection 2 (N.C.)	V/f CL-V/f OLV CLV AOLV OLV/PM AOLV/PM CLV/PM EZOLV The terminal deactivates when the drive detects overtorque or undertorque.

Use the *L6 [Torque Detection]* parameters to set torque detection.

OFF : The output current/torque is more than the torque value set with *L6-05 [Torque Detection Level 2]*, or the level is less than the torque value set with *L6-05* for longer than the time set with *L6-06 [Torque Detection Time 2]*.

Note:

- When *L6-04* ≥ 5 , the drive will detect when the output current/torque is less than the detection level of *L6-05* for longer than the time set in *L6-06*.
- Refer to “L6: Torque Detection” for more information.

1A: During Reverse

Setting Value	Function	Description
1A	During reverse	V/f CL-V/f OLV CLV AOLV OLV/PM AOLV/PM CLV/PM EZOLV The terminal activates when the motor operates in the reverse direction.

ON : The motor is operating in the reverse direction.

OFF : The motor is operating in the forward direction or the motor stopped.

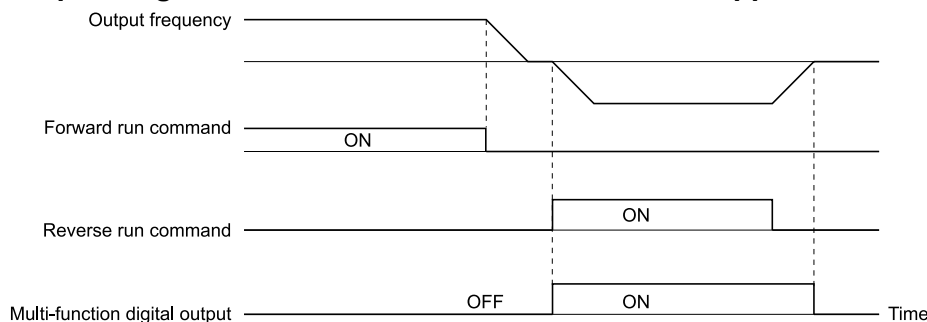

Figure 12.99 Reverse Operation Output Time Chart

1B: During Baseblock (N.C.)

Setting Value	Function	Description
1B	During Baseblock (N.C.)	V/f CL-V/f OLV CLV AOLV OLV/PM AOLV/PM CLV/PM EZOLV The terminal deactivates during baseblock. When the drive is in baseblock, the drive output transistor stops switching and does not make DC bus voltage.

ON : The drive is not in baseblock.

OFF : During baseblock**■ 1C: Motor 2 Selected**

Setting Value	Function	Description
1C	Motor 2 Selected	<div style="display: flex; justify-content: space-between; align-items: center;"> V/f CL-V/f OLV CLV AOLV OLV/PM AOLV/PM CLV/PM EZOLV </div> <p>The terminal activates when motor 2 is selected.</p>

ON : Motor 2 Selection**OFF : Motor 1 Selection****■ 1D: During Regeneration**

Setting Value	Function	Description
1D	During Regeneration	<div style="display: flex; justify-content: space-between; align-items: center;"> V/f CL-V/f OLV CLV AOLV OLV/PM AOLV/PM CLV/PM EZOLV </div> <p>The terminal activates on when the motor is regenerating.</p>

ON : Motor is regenerating.**OFF : Motor is operating or stopped.****■ 1E: Executing Auto-Restart**

Setting Value	Function	Description
1E	Executing Auto-Restart	<div style="display: flex; justify-content: space-between; align-items: center;"> V/f CL-V/f OLV CLV AOLV OLV/PM AOLV/PM CLV/PM EZOLV </div> <p>The terminal activates when the Auto Restart function is trying to restart after a fault.</p>

The terminal deactivates when the Auto Restart function automatically resets a fault. The terminal turns off when the Auto Restart function detects the fault again since Auto Restart function cannot function any longer due to number of attempts set with *L5-01 [Number of Auto Restart Attempts]* being reached.

Note:

Refer to "L5: Auto-Restart" for more information.

■ 1F: Motor Overload Alarm (oL1)

Setting Value	Function	Description
1F	Motor Overload Alarm (oL1)	<div style="display: flex; justify-content: space-between; align-items: center;"> V/f CL-V/f OLV CLV AOLV OLV/PM AOLV/PM CLV/PM EZOLV </div> <p>The terminal activates when the electronic thermal protection value of the motor overload protective function is a minimum of 90% of the detection level.</p>

Note:

Refer to "L1-01: Motor Overload (oL1) Protection" for more information.

■ 20: Drive Overheat Pre-Alarm (oH)

Setting Value	Function	Description
20	Drive Overheat Pre-Alarm (oH)	<div style="display: flex; justify-content: space-between; align-items: center;"> V/f CL-V/f OLV CLV AOLV OLV/PM AOLV/PM CLV/PM EZOLV </div> <p>The terminal activates when the drive heatsink temperature is at the level set with <i>L8-02 [Overheat Alarm Level]</i>.</p>

Note:

Refer to "L8-02: Overheat Alarm Level" for more information.

■ 21: Safe Torque OFF

Setting Value	Function	Description
21	Safe Torque OFF	<div style="display: flex; justify-content: space-between; align-items: center;"> V/f CL-V/f OLV CLV AOLV OLV/PM AOLV/PM CLV/PM EZOLV </div> <p>The terminal activates (safety stop state) when the safety circuit and safety diagnosis circuit are operating correctly and when terminals H1-HC and H2-HC are OFF (Open).</p>

Note:

EDM = External Device Monitor

ON : Safety stop state

Terminals H1-HC and H2-HC are OFF (Open) (safety stop state).

OFF : Safety circuit fault or RUN/READY

Terminal H1-HC or terminal H2-HC is OFF (Open) (safety circuit fault), or the two terminals are ON or have short circuited (RUN/READY).

22: Mechanical Weakening Detection

Setting Value	Function	Description
22	Mechanical Weakening Detection	V/f CL-V/f OLV CLV AOLV OLV/PM AOLV/PM CLV/PM EZOLV The terminal activates when the drive detects mechanical weakening.

Note:

Refer to “Mechanical Weakening Detection Function” for more information.

2F: Maintenance Notification

Setting Value	Function	Description
2F	Maintenance Notification	V/f CL-V/f OLV CLV AOLV OLV/PM AOLV/PM CLV/PM EZOLV The terminal activates when drive components are at their estimated maintenance period.

Tells the user about the maintenance period for these items:

- IGBT
- Cooling fan
- Capacitor
- Soft charge bypass relay

Note:

Refer to “Alarm Outputs for Maintenance Monitors” for more information.

30: During Torque Limit

Setting Value	Function	Description
30	During Torque Limit	V/f CL-V/f OLV CLV AOLV OLV/PM AOLV/PM CLV/PM EZOLV The terminal activates when the torque reference is the torque limit set with <i>L7 parameters, H3-02, H3-06, or H3-10 [MFAI Function Selection]</i> .

Note:

Refer to “L7: Torque Limit” for more information.

31: During Speed Limit

Setting Value	Function	Description
31	During Speed Limit	V/f CL-V/f OLV CLV AOLV OLV/PM AOLV/PM CLV/PM EZOLV The terminal activates when the speed limit is active.

The speed limit activates and the terminal activates in these conditions:

- The frequency reference $\geq d2-01$ [*Frequency Reference Upper Limit*]
- The frequency reference $\leq d2-02$ [*Frequency Reference Lower Limit*] or $d2-03$ [*Analog Frequency Ref Lower Limit*].
- The frequency reference $\leq E1-09$ [*Minimum Output Frequency*] when $b1-05 = 1, 2, \text{ or } 3$ [*Operation Below Minimum Freq = Baseblock (Motor Coasts), Operate at Minimum Frequency, or Operate at Zero Speed*].
- The frequency reference \leq *Output Freq Lower Limit Level [H3-xx = 9]* through analog input.

32: In Speed Limit During Trq Ctrl

Setting Value	Function	Description
32	In Speed Limit During Trq Ctrl	V/f CL-V/f OLV CLV AOLV OLV/PM AOLV/PM CLV/PM EZOLV The motor accelerates in the forward direction or the reverse direction after enabling torque control and the externally input torque reference is disproportionate to the load. The output terminal activates when this speed is not higher than a constant speed and the motor speed is at the speed limit. This does not include operation when the drive is stopped.

Note:

Refer to “d5-03: Speed Limit Selection” for more information.

■ 33: Zero Servo Complete

Setting Value	Function	Description
33	Zero Servo Complete	<div style="display: flex; justify-content: space-between; font-size: small;"> V/f CL-V/f OLV CLV AOLV OLV/PM AOLV/PM CLV/PM EZOLV </div> <p>The terminal activates when positioning in the range set with b9-02 [Zero Servo Completion Window] completes after sending the Zero-Servo command.</p>

Note:

Refer to “b9: Zero Servo” for more information.

■ 37: During Frequency Output

Setting Value	Function	Description
37	During Frequency Output	<div style="display: flex; justify-content: space-between; font-size: small;"> V/f CL-V/f OLV CLV AOLV OLV/PM AOLV/PM CLV/PM EZOLV </div> <p>The terminal activates when the drive outputs frequency.</p>

ON : The drive outputs frequency.

OFF : The drive does not output frequency.

Note:

The terminal deactivates in these conditions:

- During Stop
- During baseblock
- During DC Injection Braking (initial excitation)
- During Short Circuit Braking

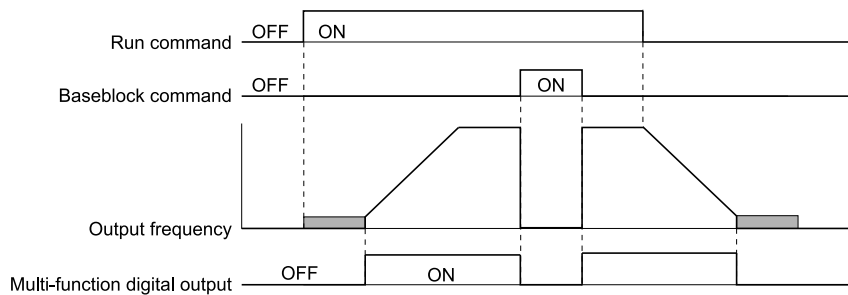

Figure 12.100 Active Frequency Output Time Chart

■ 38: Drive Enabled

Setting Value	Function	Description
38	Drive Enabled	<div style="display: flex; justify-content: space-between; font-size: small;"> V/f CL-V/f OLV CLV AOLV OLV/PM AOLV/PM CLV/PM EZOLV </div> <p>This terminal activates when the H1-xx = 6A [Drive Enable] terminal activates.</p>

■ 39: Watt Hour Pulse Output

Setting Value	Function	Description
39	Watt Hour Pulse Output	<div style="display: flex; justify-content: space-between; font-size: small;"> V/f CL-V/f OLV CLV AOLV OLV/PM AOLV/PM CLV/PM EZOLV </div> <p>Outputs the pulse that shows the watt hours.</p>

Note:

Refer to “H2-06: Watt Hour Output Unit Selection” for more information.

■ 3C: LOCAL Control Selected

Setting Value	Function	Description
3C	LOCAL Control Selected	<div style="display: flex; justify-content: space-between; font-size: small;"> V/f CL-V/f OLV CLV AOLV OLV/PM AOLV/PM CLV/PM EZOLV </div> <p>The terminal activates when the Run command source or frequency reference source is LOCAL.</p>

ON : LOCAL

The keypad is the Run command source or the frequency reference source.

OFF : REMOTE

The Run command source or frequency reference source is an external source set with *b1-01 [Frequency Reference Selection 1]*, *b1-15 [Frequency Reference Selection 2]*, *b1-02 [Run Command Selection 1]*, or *b1-16 [Run Command Selection 2]*.

■ 3D: During Speed Search

Setting Value	Function	Description
3D	During Speed Search	<div style="display: flex; justify-content: space-between; align-items: center;"> V/f CL-V/f OLV CLV AOLV OLV/PM AOLV/PM CLV/PM EZOLV </div> <p>The terminal activates when the drive is doing speed search.</p>

Note:

Refer to “b3: Speed Search” for more information.

■ 3E: PID Feedback Low

Setting Value	Function	Description
3E	PID Feedback Low	<div style="display: flex; justify-content: space-between; align-items: center;"> V/f CL-V/f OLV CLV AOLV OLV/PM AOLV/PM CLV/PM EZOLV </div> <p>The terminal activates when the drive detects <i>FbL [PID Feedback Loss]</i>.</p>

The drive detects *FbL [PID Feedback Loss]* when the PID feedback value < *b5-13 [PID Feedback Loss Detection Lvl]* for longer than the time set in *b5-14 [PID Feedback Loss Detection Time]*.

Note:

Refer to “PID Feedback Loss Detection” for more information.

■ 3F: PID Feedback High

Setting Value	Function	Description
3F	PID Feedback High	<div style="display: flex; justify-content: space-between; align-items: center;"> V/f CL-V/f OLV CLV AOLV OLV/PM AOLV/PM CLV/PM EZOLV </div> <p>The terminal activates when the drive detects <i>FbH [Excessive PID Feedback]</i>.</p>

The drive detects *FbH [Excessive PID Feedback]* when the PID feedback value > *b5-36 [PID High Feedback Detection Lvl]* for longer than the time set in *b5-37 [PID High Feedback Detection Time]*.

Note:

Refer to “PID Feedback Loss Detection” for more information.

■ 4A: During KEB Ride-Thru

Setting Value	Function	Description
4A	During KEB Ride-Thru	<div style="display: flex; justify-content: space-between; align-items: center;"> V/f CL-V/f OLV CLV AOLV OLV/PM AOLV/PM CLV/PM EZOLV </div> <p>The activates during KEB Ride-Thru.</p>

Note:

Refer to “KEB Ride-Thru function” for more information.

■ 4B: During Short Circuit Braking

Setting Value	Function	Description
4B	During Short Circuit Braking	<div style="display: flex; justify-content: space-between; align-items: center;"> V/f CL-V/f OLV CLV AOLV OLV/PM AOLV/PM CLV/PM EZOLV </div> <p>The terminal activates during Short Circuit Braking.</p>

Note:

- When *A1-02 = 8 [Control Method Selection = EZOLV]*, this function is available when you use a PM motor.
- Refer to “b2: DC Injection Braking and Short Circuit Braking” for more information.

■ 4C: During Fast Stop

Setting Value	Function	Description
4C	During Fast Stop	<div style="display: flex; justify-content: space-between; align-items: center;"> V/f CL-V/f OLV CLV AOLV OLV/PM AOLV/PM CLV/PM EZOLV </div> <p>The terminal activates when the fast stop is in operation.</p>

■ 4D: oH Pre-Alarm Reduction Limit

Setting Value	Function	Description
4D	oH Pre-Alarm Time Limit	<div style="display: flex; justify-content: space-between; gap: 5px;"> V/f CL-V/f OLV CLV AOLV OLV/PM AOLV/PM CLV/PM EZOLV </div> <p>The terminal activates when L8-03 = 4 [Overheat Pre-Alarm Selection = Operate at Reduced Speed (L8-19)] and oH [Heatsink Overheat] does not clear after the drive decreases the frequency for 10 cycles.</p>

Note:

Refer to “L8-03: Overheat Pre-Alarm Selection” for more information.

■ 4E: Braking Transistor Fault (rr)

Setting Value	Function	Description
4E	Braking Transistor Fault (rr)	<div style="display: flex; justify-content: space-between; gap: 5px;"> V/f CL-V/f OLV CLV AOLV OLV/PM AOLV/PM CLV/PM EZOLV </div> <p>The terminal activates when the internal braking transistor overheats and the drive detects an rr [Dynamic Braking Transistor Fault] fault.</p>

■ 4F: Braking Resistor Overheat (rH)

Setting Value	Function	Description
4F	Braking Resistor Overheat (rH)	<div style="display: flex; justify-content: space-between; gap: 5px;"> V/f CL-V/f OLV CLV AOLV OLV/PM AOLV/PM CLV/PM EZOLV </div> <p>The terminal activates when the braking resistor overheats and the drive detects an rH [Braking Resistor Overheat] fault.</p>

The braking resistor overheats when the deceleration time is short and there is too much motor regeneration energy.

■ 60: Internal Cooling Fan Failure

Setting Value	Function	Description
60	Internal Cooling Fan Failure	<div style="display: flex; justify-content: space-between; gap: 5px;"> V/f CL-V/f OLV CLV AOLV OLV/PM AOLV/PM CLV/PM EZOLV </div> <p>The terminal activates when the drive detects a cooling fan failure in the drive.</p>

■ 61: Pole Position Detection Complete

Setting Value	Function	Description
61	Pole Position Detection Complete	<div style="display: flex; justify-content: space-between; gap: 5px;"> V/f CL-V/f OLV CLV AOLV OLV/PM AOLV/PM CLV/PM EZOLV </div> <p>The terminal activates when drive receives a Run command and the drive detects the motor magnetic pole position of the PM motor.</p>

■ 62: Modbus Reg 1 Status Satisfied

Setting Value	Function	Description
62	Modbus Reg 1 Status Satisfied	<div style="display: flex; justify-content: space-between; gap: 5px;"> V/f CL-V/f OLV CLV AOLV OLV/PM AOLV/PM CLV/PM EZOLV </div> <p>The terminal activates when the bit specified by H2-08 [Modbus Register 1 Bit Select] for the MEMOBUS register address set with H2-07 [Modbus Register 1 Address Select] activates.</p>

■ 63: Modbus Reg 2 Status Satisfied

Setting Value	Function	Description
63	Modbus Reg 2 Status Satisfied	<div style="display: flex; justify-content: space-between; gap: 5px;"> V/f CL-V/f OLV CLV AOLV OLV/PM AOLV/PM CLV/PM EZOLV </div> <p>The terminal activates when the bit specified by H2-10 [Modbus Register 2 Bit Select] for the MEMOBUS register address set with H2-09 [Modbus Register 2 Address Select] activates.</p>

■ 65: Standby Output

Setting Value	Function	Description
65	Standby Output	<div style="display: flex; justify-content: space-between; gap: 5px;"> V/f CL-V/f OLV CLV AOLV OLV/PM AOLV/PM CLV/PM EZOLV </div> <p>The terminal deactivates after the drive stops operating and after the time set with b8-51 [Standby Mode Wait Time].</p>

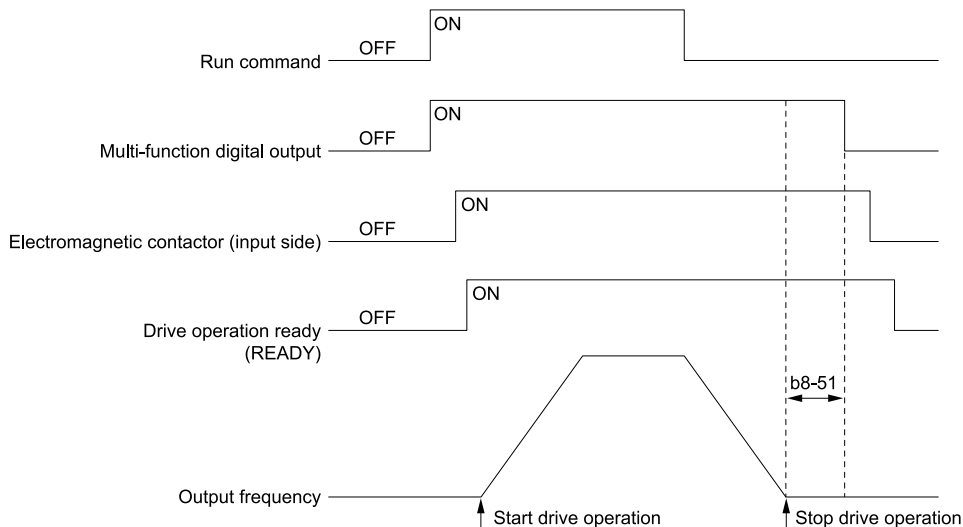

ON : The Run command turns on and the magnetic contactor on the input side turns on.
OFF : The Run command turns off and the drive stops operating. Then, the magnetic contactor on the input side turns off after the time set with *b8-51* [Standby Mode Wait Time] elapses.

66: Comparator1

Setting Value	Function	Description
66	Comparator1	<p>V/f CL-V/f OLV CLV AOLV OLV/PM AOLV/PM CLV/PM EZOLV</p> <p>The terminal activates if the monitor value set with <i>H2-20</i> [Comparator 1 Monitor Selection] is in range of the values of <i>H2-21</i> [Comparator 1 Lower Limit] and <i>H2-22</i> [Comparator 1 Upper Limit] for the time set in <i>H2-24</i> [Comparator 1 On-Delay Time].</p>

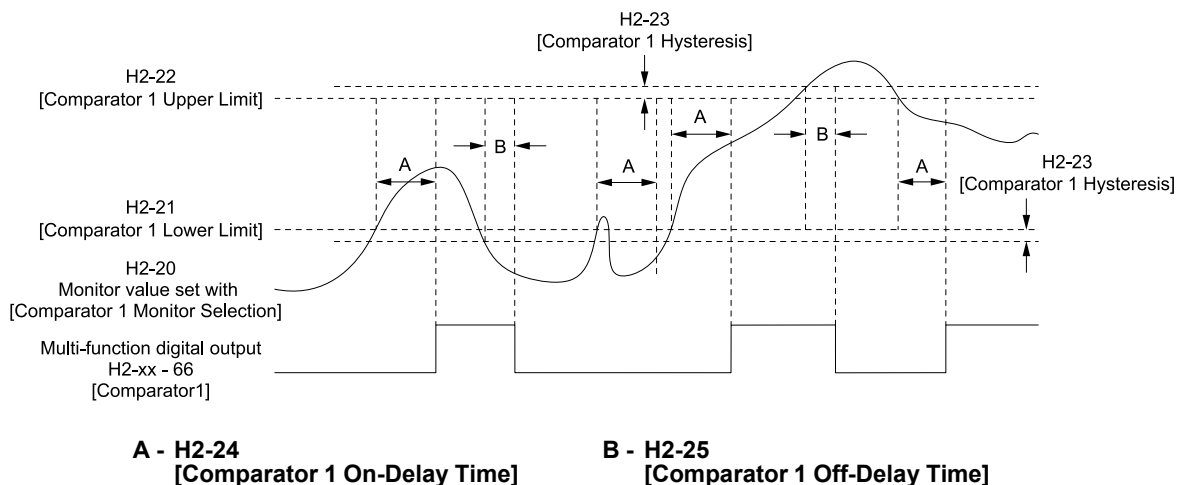

Figure 12.101 Comparator 1 Output Time Chart

Note:
 The drive compares the monitors set with *H2-20* as absolute values.

67: Comparator2

Setting Value	Function	Description
67	Comparator2	<p>V/f CL-V/f OLV CLV AOLV OLV/PM AOLV/PM CLV/PM EZOLV</p> <p>The terminal activates if the monitor value set with <i>H2-26</i> [Comparator 2 Monitor Selection] is not in the range of the values of <i>H2-27</i> [Comparator 2 Lower Limit] and <i>H2-28</i> [Comparator 2 Upper Limit] for the time set in <i>H2-30</i> [Comparator 2 On-Delay Time].</p>

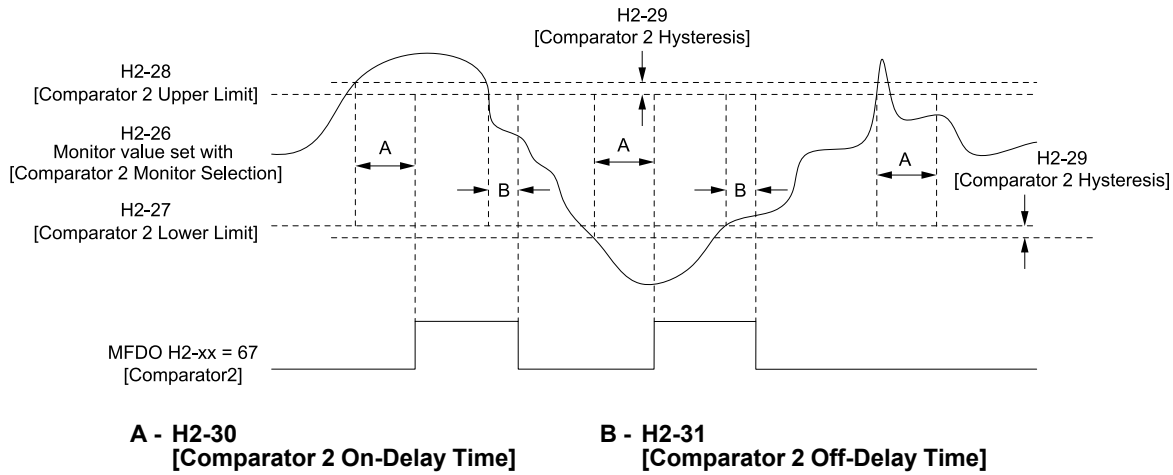

Figure 12.102 Comparator 2 Output Time Chart

Note:

The drive compares the monitors set with H2-26 as absolute values.

■ **69: External Power 24V Supply**

Setting Value	Function	Description
69	External Power 24V Supply	V/f CL-V/f OLV CLV AOLV OLV/PM AOLV/PM CLV/PM EZOLV The terminal activates when there is an external 24V power supply between terminals PS-AC.

ON : An external 24V power supply supplies power.

OFF : An external 24V power supply does not supply power.

■ **6A: Data Logger Error**

Setting Value	Function	Description
6A	Data Logger Error	V/f CL-V/f OLV CLV AOLV OLV/PM AOLV/PM CLV/PM EZOLV The terminal activates when the drive detects LoG [Com Error / Abnormal SD card].

■ **90 to 93: DWEZ Digital Outputs 1 to 4**

Setting Value	Function	Description
90 to 93	DWEZ Digital Outputs 1 to 4	V/f CL-V/f OLV CLV AOLV OLV/PM AOLV/PM CLV/PM EZOLV Sets the DriveWorksEZ digital output. Refer to the DriveWorksEZ online manual for more information.

■ **A0 to A7: DWEZ Extended Digital Output 1 to 8**

Setting Value	Function	Description
A0 to A7	DWEZ Extended Digital Outputs 1 to 8	V/f CL-V/f OLV CLV AOLV OLV/PM AOLV/PM CLV/PM EZOLV Sets the digital output for the DriveWorksEZ DO-A3 option card. Refer to the DriveWorksEZ online manual for more information.

■ **100 to 1A7: Inverse Outputs of 0 to A7**

Setting Value	Function	Description
100 to 1A7	Inverse Outputs of 0 to A7	V/f CL-V/f OLV CLV AOLV OLV/PM AOLV/PM CLV/PM EZOLV Causes inverse output of the function for the selected MFDO. Uses the last two digits of 1xx to select which function to inversely output.

For example, set H2-xx = 10E for the inverse output of E [Fault].

◆ **H3: Analog Inputs**

WARNING! Sudden Movement Hazard. Do test runs and examine the drive to make sure that the command references are correct. If you set the command reference incorrectly, it can cause damage to the drive or serious injury or death.

Drives have three analog input terminals, terminals A1, A2, and A3. *H3 parameters* select the functions set to these analog input terminals and adjust signal levels.

Table 12.64 shows the functions that you can set to analog input terminals. Use *H3-02*, *H3-06*, and *H3-10* [*MFAI Function Selection*] to set functions.

Table 12.64 MFAI Setting Values

Setting Value	Function	Ref.	Setting Value	Function	Ref.
0	Frequency Reference	878	E	Motor Temperature (PTC Input)	881
1	Frequency Gain	878	F	Not Used	881
2	Auxiliary Frequency Reference 1	878	10	Forward Torque Limit	881
3	Auxiliary Frequency Reference 2	879	11	Reverse Torque Limit	882
4	Output Voltage Bias	879	12	Regenerative Torque Limit	883
5	Accel/Decel Time Gain	879	13	Torque Reference / Torque Limit	883
6	DC Injection Braking Current	879	14	Torque Compensation	883
7	Torque Detection Level	880	15	General Torque Limit	883
8	Stall Prevent Level During Run	880	16	Differential PID Feedback	883
9	Output Frequency Lower Limit	880	1F	Not Used	883
B	PID Feedback	880	30	DWEZ Analog Input 1	883
C	PID Setpoint	881	31	DWEZ Analog Input 2	883
D	Frequency Bias	881	32	DWEZ Analog Input 3	884

Note:

All analog input scaling uses gain and bias for adjustment. Set the gain and bias values correctly.

Example Analog Input Settings	Setting of Terminal A1	Frequency Reference
<p>Frequency reference with the gain setting adjusted</p>	<ul style="list-style-type: none"> H3-02 = 0 [Terminal A1 Function Selection = Frequency Reference] H3-03: 200.0 [Terminal A1 Gain Setting = 200%] H3-04 = 0.0 [Terminal A1 Bias Setting = 0.0%] 	<ul style="list-style-type: none"> When you input a 10 V signal, the frequency reference will be 200%. When you input a 5 V signal, the frequency reference will be 100%. <p>When you input a 5 V or more signal, <i>E1-04</i> [Maximum Output Frequency] will limit the drive output and the frequency reference will be 100%.</p> <div style="display: flex; justify-content: space-around;"> <div style="text-align: center;"> <p>H3-01 = 0</p> </div> <div style="text-align: center;"> <p>H3-01 = 1</p> </div> </div>
<p>Frequency reference with the negative number bias set</p>	<ul style="list-style-type: none"> H3-02 = 0 [Frequency Reference] H3-03 = 100.0 [100.0%] H3-04 = -25.0 [-25.0%] 	<ul style="list-style-type: none"> When you input a 0 V signal, the frequency reference will be -25%. When <i>H3-01</i> = 0 [Terminal A1 Signal Level Select = 0 to 10V (Lower Limit at 0)]: <ul style="list-style-type: none"> When you input a 0 V to 2 V signal, the frequency reference will be 0%. When you input a 2 V to 10 V signal, the frequency reference will be 0% to 100%. When <i>H3-01</i> = 1 [-10 to +10V (Bipolar Reference)]: <ul style="list-style-type: none"> When you input a 0 V to 2 V signal, it enables signals of positive and negative polarities and the motor rotates in reverse. <div style="display: flex; justify-content: space-around;"> <div style="text-align: center;"> <p>H3-01 = 0</p> </div> <div style="text-align: center;"> <p>H3-01 = 1</p> </div> </div>

MEMOBUS/Modbus Multi-Function A1 to 3 Function Selection

Let the MFAI function be assigned to MEMOBUS/Modbus register 15C1 to 15C3 (Hex.) [Mbus Reg 15C1h through 15C3h Input Function]. Use H3-40 to H3-42 [Mbus Reg 15C1h through 15C3h Input Function] to set the function and use H3-43 [Mbus Reg Inputs FilterTime Const] to set the input filter.

Table 12.65 MEMOBUS Multi-Function AI Command Register

Register No. (Hex.)	Name	Range *1	Parameter
15C1	Mbus Reg 15C1h Input Function	-32767 to 32767	H3-40
15C2	Mbus Reg 15C2h Input Function	-32767 to 32767	H3-41
15C3	Mbus Reg 15C3h Input Function	-32767 to 32767	H3-42

*1 Set as 100% = 4096.

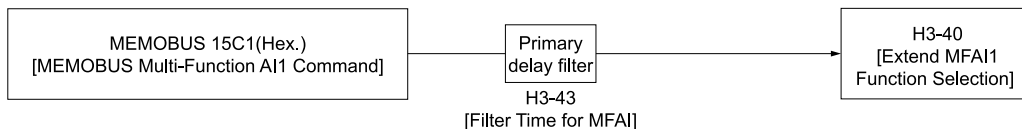

Figure 12.103 Functional Block Diagram for MEMOBUS Multi-Function AI Command 1

Note:

- Refer to H3-xx “MFAI Setting Values” for the analog input setting values.
- When you will not use the terminal, set H3-40 to H3-42 = F. The through mode function is not supported.
- You cannot use H3-40 to H3-42 to set these MFAI terminals:

H3-xx Setting Value	Function
0	Frequency Reference
1	Frequency Gain
2	Auxiliary Frequency Reference 1
3	Auxiliary Frequency Reference 2
30	DWEZ Analog Input 1
31	DWEZ Analog Input 2
32	DWEZ Analog Input 3

◆ H3: MFAI Parameters

■ H3-01: Terminal A1 Signal Level Select

No. (Hex.)	Name	Description	Default (Range)
H3-01 (0410)	Terminal A1 Signal Level Select	<input type="radio"/> V/f <input type="radio"/> CL-V/f <input type="radio"/> OLV <input type="radio"/> CLV <input type="radio"/> AOLV <input type="radio"/> OLV/PM <input type="radio"/> AOLV/PM <input type="radio"/> CLV/PM <input type="radio"/> EZOLV Sets the input signal level for MFAI terminal A1.	0 (0 - 3)

0 : 0 to 10V (Lower Limit at 0)

The voltage signal is 0 Vdc to 10 Vdc. The minimum input level limit is 0%. The drive will read a negative input signal caused by gain and bias settings as 0%.

1 : -10 to +10V (Bipolar Reference)

The voltage signal is -10 Vdc to 10 Vdc. This setting enables positive and negative polarity signals. When the drive uses this setting as the frequency reference, a Forward Run command will run the motor in reverse and a Reverse Run command will run the motor forward. The gain and bias settings will cause the signal to be a negative number.

2 : 4 to 20 mA

The current signal is 4 mA to 20 mA. The minimum input level limit is 0%. The drive will read a negative input signal caused by gain and bias settings as 0%.

3 : 0 to 20 mA

The current signal is 0 mA to 20 mA. The minimum input level limit is 0%. The drive will read a negative input signal caused by gain and bias settings as 0%.

Note:

When H3-01 = 0, 1, set DIP switch S1-1 to the V side (voltage). When H3-01 = 2, 3, set DIP switch S1-1 to the I side (current). The default setting is the V side (voltage).

■ H3-02: Terminal A1 Function Selection

No. (Hex.)	Name	Description	Default (Range)
H3-02 (0434)	Terminal A1 Function Selection	<input type="radio"/> V/f <input type="radio"/> CL-V/f <input type="radio"/> OLV <input type="radio"/> CLV <input type="radio"/> AOLV <input type="radio"/> OLV/PM <input type="radio"/> AOLV/PM <input type="radio"/> CLV/PM <input type="radio"/> EZOLV Sets the function for MFAI terminal A1.	0 (0 - 32)

■ H3-03: Terminal A1 Gain Setting

No. (Hex.)	Name	Description	Default (Range)
H3-03 (0411) RUN	Terminal A1 Gain Setting	<input type="radio"/> V/f <input type="radio"/> CL-V/f <input type="radio"/> OLV <input type="radio"/> CLV <input type="radio"/> AOLV <input type="radio"/> OLV/PM <input type="radio"/> AOLV/PM <input type="radio"/> CLV/PM <input type="radio"/> EZOLV Sets the gain of the analog signal input to MFAI terminal A1.	100.0% (-999.9 - +999.9%)

This parameter sets the quantity of reference for the function set for terminal A1 as a percentage when 10 V (or 20 mA) is input.

Use this parameter and *H3-04 [Terminal A1 Bias Setting]* to adjust the characteristics of the analog input signal to terminal A1.

■ H3-04: Terminal A1 Bias Setting

No. (Hex.)	Name	Description	Default (Range)
H3-04 (0412) RUN	Terminal A1 Bias Setting	<div style="display: flex; justify-content: space-between; font-size: 0.8em; font-weight: bold;"> V/f CL-V/f OLV CLV AOLV OLV/PM AOLV/PM CLV/PM EZOLV </div> <p>Sets the bias of the analog signal input to MFAI terminal A1.</p>	0.0% (-999.9 - +999.9%)

This parameter sets the bias for the function set for terminal A1 as a percentage when 0 V (4 mA or 0 mA) is input.

Use this parameter and *H3-03 [Terminal A1 Gain Setting]* to adjust the characteristics of the analog input signal to terminal A1.

■ H3-05: Terminal A3 Signal Level Select

No. (Hex.)	Name	Description	Default (Range)
H3-05 (0413)	Terminal A3 Signal Level Select	<div style="display: flex; justify-content: space-between; font-size: 0.8em; font-weight: bold;"> V/f CL-V/f OLV CLV AOLV OLV/PM AOLV/PM CLV/PM EZOLV </div> <p>Sets the input signal level for MFAI terminal A3.</p>	0 (0 - 3)

0 : 0-10V (LowLim=0)

The voltage signal is 0 Vdc to 10 Vdc. The minimum input level limit is 0%. The drive will read a negative input signal caused by gain and bias settings as 0%.

1 : -10 to +10V (Bipolar Reference)

The voltage signal is -10 Vdc to 10 Vdc. This setting enables positive and negative polarity signals. When the drive uses this setting as the frequency reference, a Forward Run command will run the motor in reverse and a Reverse Run command will run the motor forward. The gain and bias settings will cause the signal to be a negative number.

2 : 4 to 20 mA

The current signal is 4 mA to 20 mA. The minimum input level limit is 0%. The drive will read a negative input signal caused by gain and bias settings as 0%.

3 : 0 to 20 mA

The current signal is 0 mA to 20 mA. The minimum input level limit is 0%. The drive will read a negative input signal caused by gain and bias settings as 0%.

Note:

When *H3-05 = 0, 1*, set DIP switch S1-3 to the V side (voltage). When *H3-05 = 2, 3*, set DIP switch S1-3 to the I side (current). The default setting is the V side (voltage).

■ H3-06: Terminal A3 Function Selection

No. (Hex.)	Name	Description	Default (Range)
H3-06 (0414)	Terminal A3 Function Selection	<div style="display: flex; justify-content: space-between; font-size: 0.8em; font-weight: bold;"> V/f CL-V/f OLV CLV AOLV OLV/PM AOLV/PM CLV/PM EZOLV </div> <p>Sets the function for MFAI terminal A3.</p>	2 (0 - 32)

Note:

When terminal A3 is the PTC input terminal:

- Set H3-06 = E [Motor Temperature (PTC input)]
- Set DIP switch S4 to the PTC side
- Set DIP switch S1-3 to the V side

■ H3-07: Terminal A3 Gain Setting

No. (Hex.)	Name	Description	Default (Range)
H3-07 (0415) RUN	Terminal A3 Gain Setting	<div style="display: flex; justify-content: space-between; font-size: 0.8em; font-weight: bold;"> V/f CL-V/f OLV CLV AOLV OLV/PM AOLV/PM CLV/PM EZOLV </div> Sets the gain of the analog signal input to MFAI terminal A3.	100.0% (-999.9 - +999.9%)

When 10 V (or 20 mA) is input, this parameter sets the reference quantity for the function set for terminal A3 as a percentage.

Use this parameter and *H3-08 [Terminal A3 Bias Setting]* to adjust the characteristics of the analog input signal to terminal A3.

■ H3-08: Terminal A3 Bias Setting

No. (Hex.)	Name	Description	Default (Range)
H3-08 (0416) RUN	Terminal A3 Bias Setting	<div style="display: flex; justify-content: space-between; font-size: 0.8em; font-weight: bold;"> V/f CL-V/f OLV CLV AOLV OLV/PM AOLV/PM CLV/PM EZOLV </div> Sets the bias of the analog signal input to MFAI terminal A3.	0.0% (-999.9 - +999.9%)

When 0 V (4 mA or 0 mA) is input, this parameter sets the bias for the function set for terminal A3 as a percentage.

Use this parameter and *H3-07 [Terminal A3 Gain Setting]* to adjust the characteristics of the analog input signal to terminal A3.

■ H3-09: Terminal A2 Signal Level Select

No. (Hex.)	Name	Description	Default (Range)
H3-09 (0417)	Terminal A2 Signal Level Select	<div style="display: flex; justify-content: space-between; font-size: 0.8em; font-weight: bold;"> V/f CL-V/f OLV CLV AOLV OLV/PM AOLV/PM CLV/PM EZOLV </div> Sets the input signal level for MFAI terminal A2.	2 (0 - 3)

0 : 0-10V (LowLim=0)

The voltage signal is 0 Vdc to 10 Vdc. The minimum input level is limited to 0%, so that a negative input signal due to gain and bias settings will be read as 0%.

1 : -10 to +10V (Bipolar Reference)

The voltage signal is -10 Vdc to 10 Vdc. Signals of both positive and negative polarities are enabled. When this setting is used as the frequency reference, the motor runs reverse when the Forward run command is input, or runs forward when the Reverse run signal is input, while the signal is a negative number due to gain and bias.

2 : 4 to 20 mA

The current signal is 4 mA to 20 mA. The minimum input level is limited to 0%, so that a negative input signal due to gain and bias settings will be read as 0%.

3 : 0 to 20 mA

The current signal is 0 mA to 20 mA. The minimum input level is limited to 0%, so that a negative input signal due to gain and bias settings will be read as 0%.

Note:

When *H3-09 = 0, 1*, set DIP switch S1-2 to the V side (voltage). When *H3-09 = 2, 3*, set DIP switch S1-2 to the I side (current). The default setting is the I side (current).

■ H3-10: Terminal A2 Function Selection

No. (Hex.)	Name	Description	Default (Range)
H3-10 (0418)	Terminal A2 Function Selection	<div style="display: flex; justify-content: space-between; font-size: 0.8em; font-weight: bold;"> V/f CL-V/f OLV CLV AOLV OLV/PM AOLV/PM CLV/PM EZOLV </div> Sets the function for MFAI terminal A2.	0 (0 - 32)

■ H3-11: Terminal A2 Gain Setting

No. (Hex.)	Name	Description	Default (Range)
H3-11 (0419) RUN	Terminal A2 Gain Setting	<div style="display: flex; justify-content: space-between; font-size: 0.8em; font-weight: bold;"> V/f CL-V/f OLV CLV AOLV OLV/PM AOLV/PM CLV/PM EZOLV </div> Sets the gain of the analog signal input to MFAI terminal A2.	100.0% (-999.9 - +999.9%)

When 10 V (or 20 mA) is input, this parameter sets the reference quantity for the function set for terminal A2 as a percentage.

Use this parameter and *H3-12 [Terminal A2 Bias Setting]* to adjust the characteristics of the analog input signal to terminal A2.

■ H3-12: Terminal A2 Bias Setting

No. (Hex.)	Name	Description	Default (Range)
H3-12 (041A) RUN	Terminal A2 Bias Setting	<div style="display: flex; justify-content: space-between; font-size: 0.8em; font-weight: bold;"> V/f CL-V/f OLV CLV AOLV OLV/PM AOLV/PM CLV/PM EZOLV </div> Sets the bias of the analog signal input to MFAI terminal A2.	0.0% (-999.9 - +999.9%)

When 0 V (4 mA or 0 mA) is input, this parameter sets the bias for the function set for terminal A2 as a percentage.

Use this parameter and *H3-11 [Terminal A2 Gain Setting]* to adjust the characteristics of the analog input signal to terminal A2.

■ H3-13: Analog Input FilterTime Constant

No. (Hex.)	Name	Description	Default (Range)
H3-13 (041B)	Analog Input FilterTime Constant	<div style="display: flex; justify-content: space-between; font-size: 0.8em; font-weight: bold;"> V/f CL-V/f OLV CLV AOLV OLV/PM AOLV/PM CLV/PM EZOLV </div> Sets the time constant for primary delay filters on MFAI terminals.	0.03 s (0.00 - 2.00 s)

Apply the primary delay filter to the analog input to enable an analog input signal without the use of high-frequency noise components. An analog input filter prevents irregular drive control. Drive operation becomes more stable as the programmed time becomes longer, but it also becomes less responsive to quickly changing analog signals.

■ H3-14: Analog Input Terminal Enable Sel

No. (Hex.)	Name	Description	Default (Range)
H3-14 (041C)	Analog Input Terminal Enable Sel	<div style="display: flex; justify-content: space-between; font-size: 0.8em; font-weight: bold;"> V/f CL-V/f OLV CLV AOLV OLV/PM AOLV/PM CLV/PM EZOLV </div> Sets the enabled terminal or terminals when $H1-xx = C$ [MFDI Function Select = Analog Terminal Enable Selection] is ON.	7 (1 - 7)

Input signals do not have an effect on terminals not set as targets.

1 : Terminal A1 only

2 : Terminal A2 only

3 : Terminals A1 and A2

4 : Terminal A3 only

5 : Terminals A1 and A3

6 : Terminals A2 and A3

7 : Terminals A1, A2, and A3

Note:

- The ON/OFF operation of terminal Sx set in *Analog Terminal Input Selection* [$H1-xx = C$] has an effect on only the analog input terminal selected with *H3-14*.
- When $H1-xx \neq C$, the functions set to terminals A1 to A3 are always enabled.

■ H3-16: Terminal A1 Offset

No. (Hex.)	Name	Description	Default (Range)
H3-16 (02F0)	Terminal A1 Offset	<div style="display: flex; justify-content: space-between; font-size: 0.8em; font-weight: bold;"> V/f CL-V/f OLV CLV AOLV OLV/PM AOLV/PM CLV/PM EZOLV </div> Sets the offset level for analog signals input to terminal A1. Usually it is not necessary to change this setting.	0 (-500 - +500)

Adds the offset value for the analog input value. For voltage input, this parameter will set the offset when a signal of 0 V is input. For current input, this parameter will set the offset when a signal of 4 mA [H3-01 = 2] or 0 mA [H3-01 = 3] is input.

■ H3-17: Terminal A2 Offset

No. (Hex.)	Name	Description	Default (Range)
H3-17 (02F1)	Terminal A2 Offset	<div style="display: flex; justify-content: space-between; font-size: 0.8em; font-weight: bold;"> V/f CL-V/f OLV CLV AOLV OLV/PM AOLV/PM CLV/PM EZOLV </div> Sets the offset level for analog signals input to terminal A2. Usually it is not necessary to change this setting.	0 (-500 - +500)

Adds the offset value for the analog input value. For voltage input, this parameter will set the offset when a signal of 0 V is input. For current input, this parameter will set the offset when a signal of 4 mA [H3-09 = 2] or 0 mA [H3-09 = 3] is input.

■ H3-18: Terminal A3 Offset

No. (Hex.)	Name	Description	Default (Range)
H3-18 (02F2)	Terminal A3 Offset	<div style="display: flex; justify-content: space-between; font-size: 0.8em; font-weight: bold;"> V/f CL-V/f OLV CLV AOLV OLV/PM AOLV/PM CLV/PM EZOLV </div> Sets the offset level for analog signals input to terminal A3. Usually it is not necessary to change this setting.	0 (-500 - +500)

Adds the offset value for the analog input value. For voltage input, this parameter will set the offset when a signal of 0 V is input. For current input, this parameter will set the offset when a signal of 4 mA [H3-05 = 2] or 0 mA [H3-05 = 3] is input.

■ H3-40: Mbus Reg 15C1h Input Function

No. (Hex.)	Name	Description	Default (Range)
H3-40 (0B5C)	Mbus Reg 15C1h Input Function	<div style="display: flex; justify-content: space-between; font-size: 0.8em; font-weight: bold;"> V/f CL-V/f OLV CLV AOLV OLV/PM AOLV/PM CLV/PM EZOLV </div> Sets the MEMOBUS A11 function.	F (4 - 2F)

You can use the MFAI function from MEMOBUS/Modbus communications. Use this parameter to set the function. Sets the input for the function in MEMOBUS/Modbus register 15C1.

Refer to H3-xx “MFAI Setting Values” for the setting values.

■ H3-41: Mbus Reg 15C2h Input Function

No. (Hex.)	Name	Description	Default (Range)
H3-41 (0B5F)	Mbus Reg 15C2h Input Function	<div style="display: flex; justify-content: space-between; font-size: 0.8em; font-weight: bold;"> V/f CL-V/f OLV CLV AOLV OLV/PM AOLV/PM CLV/PM EZOLV </div> Sets the MEMOBUS A12 function.	F (4 - 2F)

You can use the MFAI function from MEMOBUS/Modbus communications. Use this parameter to set the function. Sets the input for the function in MEMOBUS/Modbus register 15C2.

Refer to H3-xx “MFAI Setting Values” for the setting values.

■ **H3-42: Mbus Reg 15C3h Input Function**

No. (Hex.)	Name	Description	Default (Range)
H3-42 (0B62)	Mbus Reg 15C3h Input Function	V/f CL-V/f OLV CLV AOLV OLV/PM AOLV/PM CLV/PM EZOLV Sets the MEMOBUS AI3 function.	F (4 - 2F)

You can use the MFAI function from MEMOBUS/Modbus communications. Use this parameter to set the function. Sets the input for the function in MEMOBUS/Modbus register 15C3.

Refer to H3-xx “MFAI Setting Values” for the setting values.

■ **H3-43: Mbus Reg Inputs FilterTime Const**

No. (Hex.)	Name	Description	Default (Range)
H3-43 (117F)	Mbus Reg Inputs FilterTime Const	V/f CL-V/f OLV CLV AOLV OLV/PM AOLV/PM CLV/PM EZOLV Sets the time constant to apply a primary delay filter to the MEMOBUS analog input terminal.	0.00 s (0.00 - 2.00 s)

◆ **Multi-Function Analog Input Terminal Settings**

This section gives information about the functions set with *H3-02*, *H3-06*, and *H3-10*.

■ **0: Frequency Reference**

Setting Value	Function	Description
0	Frequency Reference	V/f CL-V/f OLV CLV AOLV OLV/PM AOLV/PM CLV/PM EZOLV The input value from the MFAI terminal set with this function becomes the master frequency reference.

- You can copy the configuration to more than one of the analog input terminals A1 through A3. When you set more than one analog input terminal with the master frequency reference, the sum value becomes the frequency bias.
- If you use this function to set the analog input value as the master frequency reference, set $b1-01 = 1$ [*Frequency Reference Selection 1 = Analog Input*]. This setting value is the default value for terminals A1 and A2.
- The frequency reference is the sum of the input values for terminals A1 and A2 when they are used at the same time. For example, when a 20% bias is input to terminal A2 while a frequency reference of 50% is input from terminal A1, the calculated frequency reference will be 70% of the maximum output frequency.

■ **1: Frequency Gain**

Setting Value	Function	Description
1	Frequency Gain	V/f CL-V/f OLV CLV AOLV OLV/PM AOLV/PM CLV/PM EZOLV The drive multiplies the analog frequency reference with the input value from the MFAI set with this function.

Example: When you set frequency gain for terminal A2

- $H3-10 = 1$ [*Terminal A2 Function Selection = Frequency Gain*]
- A 50% frequency gain is input to terminal A2
- A frequency reference of 80% is input from terminal A1

The calculated frequency reference is 40% of the maximum output frequency.

■ **2: Auxiliary Frequency Reference 1**

Setting Value	Function	Description
2	Auxiliary Frequency Reference 1	V/f CL-V/f OLV CLV AOLV OLV/PM AOLV/PM CLV/PM EZOLV Sets Reference 2 through multi-step speed reference to enable the command reference (Auxiliary Frequency Reference 1) from the analog input terminal set here. This value is a percentage where the Maximum Output Frequency setting is a setting value of 100%.

3: Auxiliary Frequency Reference 2

Setting Value	Function	Description
3	Auxiliary Frequency Reference 2	<div style="display: flex; justify-content: space-between; align-items: center;"> V/f CL-V/f OLV CLV AOLV OLV/PM AOLV/PM CLV/PM EZOLV </div> <p>Sets Reference 3 through multi-step speed reference to enable the command reference (Auxiliary Frequency Reference 2) from the analog input terminal set here. This value is a percentage where the Maximum Output Frequency setting is a setting value of 100%.</p>

4: Output Voltage Bias

Setting Value	Function	Description
4	Output Voltage Bias	<div style="display: flex; justify-content: space-between; align-items: center;"> V/f CL-V/f OLV CLV AOLV OLV/PM AOLV/PM CLV/PM EZOLV </div> <p>Set this parameter to input a bias signal and amplify the output voltage.</p>

The gain (%) for the MFAI terminals A1, A2, and A3 is 100% of the voltage class standard, which is 200 V for 200 V class drives and 400 V for 400 V class drives. The bias (%) for MFAI terminals A1, A2, and A3 is 100% of the voltage configured for *E1-05 [Maximum Output Voltage]*.

Note:

The gain for each terminal A1, A2, and A3 is configured independently with *H3-03 [Terminal A1 Gain Setting]*, *H3-11 [Terminal A2 Gain Setting]*, and *H3-07 [Terminal A3 Gain Setting]*. The bias for each terminal A1, A2, and A3 is configured independently with *H3-04 [Terminal A1 Bias Setting]*, *H3-12 [Terminal A2 Bias Setting]*, and *H3-08 [Terminal A3 Bias Setting]*.

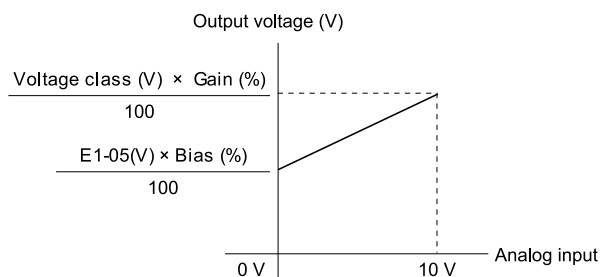

Figure 12.104 Output Voltage Bias through Analog Input

5: Accel/Decel Time Gain

Setting Value	Function	Description
5	Accel/Decel Time Gain	<div style="display: flex; justify-content: space-between; align-items: center;"> V/f CL-V/f OLV CLV AOLV OLV/PM AOLV/PM CLV/PM EZOLV </div> <p>Enters a signal to adjust the gain used for <i>C1-01 to C1-08 [Acceleration/Deceleration Times 1 to 4]</i> and <i>C1-09 [Fast Stop Time]</i> when the full scale analog signal (10 V or 20 mA) is 100%.</p>

When you enable *C1-01 [Acceleration Time 1]*, the acceleration time is:

Acceleration Time 1 = Setting value of *C1-01* × acceleration and deceleration time gain / 100

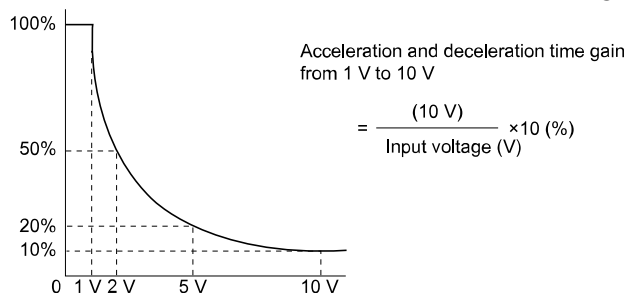

Figure 12.105 Acceleration/Deceleration Time Gain through Analog Input

6: DC Injection Braking Current

Setting Value	Function	Description
6	DC Injection Braking Current	<div style="display: flex; justify-content: space-between; align-items: center;"> V/f CL-V/f OLV CLV AOLV OLV/PM AOLV/PM CLV/PM EZOLV </div> <p>Enters a signal to adjust the current level used for DC Injection Braking when the drive rated output current is 100%.</p>

Note:

When you set this function, it will disable the setting value of b2-02 [DC Injection Braking Current].

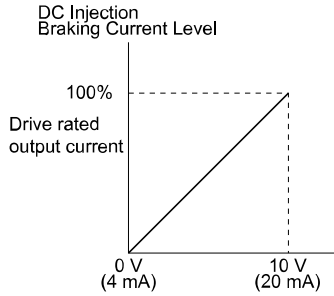

Figure 12.106 DC Injection Braking Current through Analog Input

7: Torque Detection Level

Setting Value	Function	Description
7	Torque Detection Level	V/f CL-V/f OLV CLV AOLV OLV/PM AOLV/PM CLV/PM EZOLV Enters a signal to adjust the overtorque/undertorque detection level.

When AI-02 = 0, 1, 5 [Control Method Selection = V/f, CL-V/f, OLV/PM], the drive rated current is 100%. When AI-02 = 2, 3, 4, 6, 7, 8 [OLV, CLV, AOLV, AOLV/PM, CLV/PM, EZOLV], the motor rated torque is 100%.

Note:

Use this function with L6-01 [Torque Detection Selection 1]. This parameter functions as an alternative to L6-02 [Torque Detection Level 1].

8: Stall Prevent Level During Run

Setting Value	Function	Description
8	Stall Prevent Level During Run	V/f CL-V/f OLV CLV AOLV OLV/PM AOLV/PM CLV/PM EZOLV Enters a signal to adjust the stall prevention level during run if the drive rated current is 100%.

Note:

The Stall Prevent Level During Run is based on the smaller of these two values:

- Analog input value of MFAI terminal
- L3-06 [Stall Prevent Level during Run]

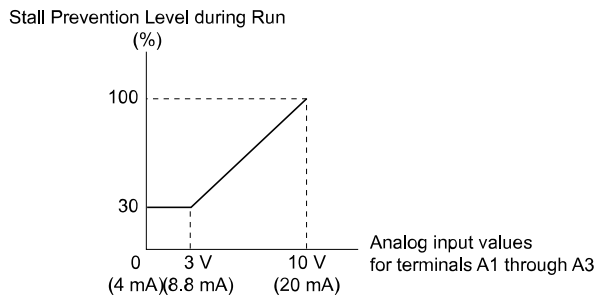

Figure 12.107 Stall Prevention Level during Run with Analog Input

9: Output Frequency Lower Limit

Setting Value	Function	Description
9	Output Frequency Lower Limit	V/f CL-V/f OLV CLV AOLV OLV/PM AOLV/PM CLV/PM EZOLV Enters a signal to adjust the output frequency lower limit level as a percentage of the maximum output frequency.

B: PID Feedback

Setting Value	Function	Description
B	PID Feedback	V/f CL-V/f OLV CLV AOLV OLV/PM AOLV/PM CLV/PM EZOLV Enter the PID feedback value as a percentage of the maximum output frequency.

When you use this function, set $b5-01 = 1$ to 8 [*PID Mode Setting = Enabled*].

■ C: PID Setpoint

Setting Value	Function	Description
C	PID Setpoint	<div style="display: flex; justify-content: space-between; align-items: center;"> V/f CL-V/f OLV CLV AOLV OLV/PM AOLV/PM CLV/PM EZOLV </div> <p>Enters the PID setpoint as a percentage of the maximum output frequency.</p>

When you use this function, set $b5-01 = 1$ to 8 [*PID Mode Setting = Enabled*].

Note:

Configuring this function disables the frequency reference set with $b1-01$ [*Frequency Reference Selection 1*].

■ D: Frequency Bias

Setting Value	Function	Description
D	Frequency Bias	<div style="display: flex; justify-content: space-between; align-items: center;"> V/f CL-V/f OLV CLV AOLV OLV/PM AOLV/PM CLV/PM EZOLV </div> <p>Enters the bias value added to the frequency reference as a percentage of the maximum output frequency.</p>

The drive adds the input value from the MFAI terminal set with this function to the frequency reference as the bias value.

Note:

When you select $d1-01$ to $d1-16$ or $d1-17$ [*Reference 1 to 16 or JOG Frequency Reference*] as the frequency reference, it will disable this function.

■ E: Motor Temperature (PTC Input)

Setting Value	Function	Description
E	Motor Temperature (PTC Input)	<div style="display: flex; justify-content: space-between; align-items: center;"> V/f CL-V/f OLV CLV AOLV OLV/PM AOLV/PM CLV/PM EZOLV </div> <p>Uses the motor Positive Temperature Coefficient (PTC) thermistor to prevent heat damage to the motor as a percentage of the current value when the 10 V analog signal is input.</p>

- You can use the Positive Temperature Coefficient (PLC) thermistor as an auxiliary or alternative detection function for $oL1$ [*Motor Overload*] problems to help prevent heat damage to motors. If the PTC input signal is more than the overload alarm level, $oH3$ [*Motor Overheat (PTC Input)*] will flash on the keypad.
- If the drive detects $oH3$, the motor stops with the method set in $L1-03$. If the drive detects $oH4$, the motor stops with the method set in $L1-04$. If the drive incorrectly detects motor overheating problems, set $L1-05$.

■ F: Not Used

Setting Value	Function	Description
F	Not Used	<div style="display: flex; justify-content: space-between; align-items: center;"> V/f CL-V/f OLV CLV AOLV OLV/PM AOLV/PM CLV/PM EZOLV </div> <p>Use this setting for unused terminals or to use terminals in through mode.</p>

When you set a terminal that is not in use to F, you can use the signal input to the terminal as PLC analog signal input through MEMOBUS/Modbus communications or the communication option. This input signal does not have an effect on drive operation. This functions the same as setting 1F (Through Mode).

■ 10: Forward Torque Limit

Setting Value	Function	Description
10	Forward Torque Limit	<div style="display: flex; justify-content: space-between; align-items: center;"> V/f CL-V/f OLV CLV AOLV OLV/PM AOLV/PM CLV/PM EZOLV </div> <p>Enters the forward torque limit if the motor rated torque is 100%.</p>

WARNING! Sudden Movement Hazard. Set correct torque limits for applications, for example elevator applications. If you set torque limits incorrectly, motor torque that is not sufficient can cause damage to equipment and cause serious injury or death.

Torque Limit Configuration Method

Use one of these methods to set torque limits:

- Individually set the four torque limit quadrants using $L7-01$ to $L7-04$ [*Torque Limit*].
- Use MFAI to individually set the four torque limit quadrants. Set $H3-02$, $H3-06$, $H3-10 = 10, 11, 12$ [*MFAI Function Select = Forward/Reverse/Regenerative Torque Limit*].
- Use MFAI to set all four torque limit quadrants together. Set $H3-02$, $H3-06$, $H3-10 = 15$ [*General Torque Limit*].

- Use a communication option to set all four torque limit quadrants together.

Figure 12.108 shows the configuration method for each quadrant.

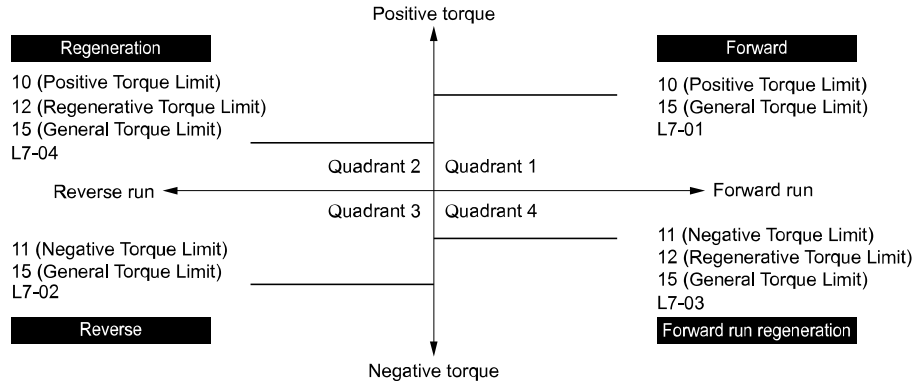

Figure 12.108 Torque Limits and Analog Input Setting Parameters

Note:

- When L7-01 to L7-04 and analog inputs or communication option torque limits set torque limits for the same quadrant, the lower value is enabled. In this example of parameter settings, the torque limit for quadrant 1 is 130% and the torque limit for quadrants 2, 3, and 4 is 150%. Settings: L7-01 = 130%, L7-02 to L7-04 = 200%, and MFAI torque limit = 150%
- The drive output current limits maximum output torque. The torque limit is 150% of the rated output current for HD and to 120% of the rated output current for ND. The actual output torque is not more than the limits of the drive rated output current when you set the torque limit to a high value.

If you use drives in applications where the vertical axis can fall, make sure that you know these items:

- Correctly configure drives and motors.
- Correctly set parameters.
- You can change parameter values after you do Auto-Tuning.
- Use a system that will not let the vertical axis fall if the drive fails.

Figure 12.109 shows the relation between torque limits from parameters and torque limits from analog input.

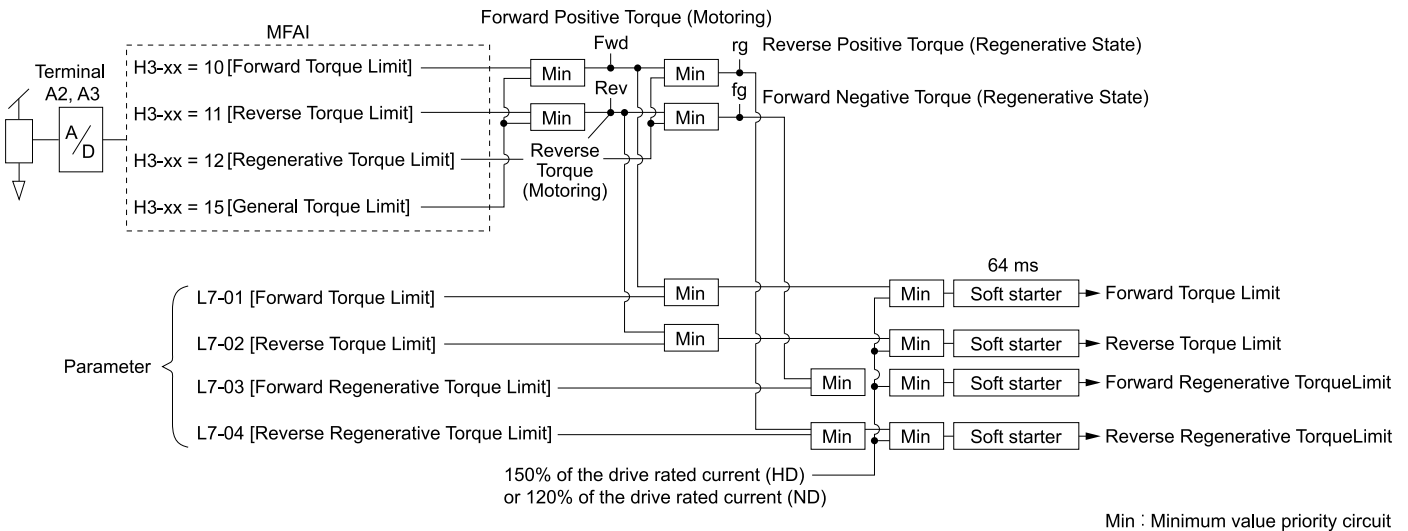

Figure 12.109 Torque Limits from Parameters and Analog Inputs

■ 11: Reverse Torque Limit

Setting Value	Function	Description
11	Reverse Torque Limit	V/f CL-V/f OLV CLV AQLV OLV/PM AQLV/PM CLV/PM EZOLV Enters the load torque limit if the motor rated torque is 100%.

Note:

When you use L7-01 to L7-04 and analog inputs to set torque limits for the same quadrant, it will enable the lower torque limit.

12: Regenerative Torque Limit

Setting Value	Function	Description
12	Regenerative Torque Limit	<div style="display: flex; justify-content: space-between; font-size: 0.8em;"> V/f CL-V/f OLV CLV AOLV OLV/PM AOLV/PM CLV/PM EZOLV </div> <p>Enters the regenerative torque limit if the motor rated torque is 100%.</p>

Note:

When you use *L7-01 to L7-04* and analog inputs to set torque limits for the same quadrant, it will enable the lower torque limit.

13: Torque Reference / Torque Limit

Setting Value	Function	Description
13	Torque Reference / Torque Limit	<div style="display: flex; justify-content: space-between; font-size: 0.8em;"> V/f CL-V/f OLV CLV AOLV OLV/PM AOLV/PM CLV/PM EZOLV </div> <p>Enters the torque reference if the motor rated torque is 100%. This setting is the torque limit for speed control.</p>

Note:

When you use *L7-01 to L7-04* and analog inputs to set torque limits for the same quadrant, it will enable the lower torque limit.

14: Torque Compensation

Setting Value	Function	Description
14	Torque Compensation	<div style="display: flex; justify-content: space-between; font-size: 0.8em;"> V/f CL-V/f OLV CLV AOLV OLV/PM AOLV/PM CLV/PM EZOLV </div> <p>Enters the torque compensation value if the motor rated torque is 100%.</p>

15: General Torque Limit

Setting Value	Function	Description
15	General Torque Limit	<div style="display: flex; justify-content: space-between; font-size: 0.8em;"> V/f CL-V/f OLV CLV AOLV OLV/PM AOLV/PM CLV/PM EZOLV </div> <p>Enters the torque limit that is the same for all quadrants for forward, reverse, and regenerative operation if the motor rated torque is 100%.</p>

16: Differential PID Feedback

Setting Value	Function	Description
16	Differential PID Feedback	<div style="display: flex; justify-content: space-between; font-size: 0.8em;"> V/f CL-V/f OLV CLV AOLV OLV/PM AOLV/PM CLV/PM EZOLV </div> <p>Enters the PID differential feedback value if the full scale analog signal (10 V or 20 mA) is 100%.</p>

The drive uses the deviation between the PID feedback and the differential feedback value signals to calculate the PID input.

1F: Not Used

Setting Value	Function	Description
1F	Not Used	<div style="display: flex; justify-content: space-between; font-size: 0.8em;"> V/f CL-V/f OLV CLV AOLV OLV/PM AOLV/PM CLV/PM EZOLV </div> <p>Use this setting for unused terminals or to use terminals in through mode.</p>

When you set a terminal that you do not use to 1F, you can use the signal that is input to that terminal as the PLC analog signal input from MEMOBUS/Modbus communications or the communication option. This input signal does not have an effect on drive operation. This signal functions the same as F (Through Mode).

30: DWEZ Analog Input 1

Setting Value	Function	Description
30	DWEZ Analog Input 1	<div style="display: flex; justify-content: space-between; font-size: 0.8em;"> V/f CL-V/f OLV CLV AOLV OLV/PM AOLV/PM CLV/PM EZOLV </div> <p>Use with DriveWorksEZ. Refer to the DriveWorksEZ online manual for more information.</p>

31: DWEZ Analog Input 2

Setting Value	Function	Description
31	DWEZ Analog Input 2	<div style="display: flex; justify-content: space-between; font-size: 0.8em;"> V/f CL-V/f OLV CLV AOLV OLV/PM AOLV/PM CLV/PM EZOLV </div> <p>Use with DriveWorksEZ. Refer to the DriveWorksEZ online manual for more information.</p>

■ 32: DWEZ Analog Input 3

Setting Value	Function	Description
32	DWEZ Analog Input 3	<div style="display: flex; justify-content: space-between; font-size: small;"> V/f CL-V/f OLV CLV AOLV OLV/PM AOLV/PM CLV/PM EZOLV </div> Use with DriveWorksEZ. Refer to the DriveWorksEZ online manual for more information.

◆ H4: Analog Outputs

H4 parameters set the drive analog monitors. These parameters select monitor parameters, adjust gain and bias, and select output signal levels.

■ Calibrate Meters Connected to MFAO Terminals FM and AM

To calibrate the meters connected to terminals FM and AM, use these parameters:

- H4-02 [Terminal FM Analog Output Gain]
- H4-03 [Terminal FM Analog Output Bias]
- H4-05 [Terminal AM Analog Output Gain]
- H4-06 [Terminal AM Analog Output Bias]

Set these parameters where the output voltage of 10 V and output current of 20 mA are 100% of the signal level. Use jumper switch S5 and H4-07 [Terminal FM Signal Level Select] or H4-08 [Terminal AM Signal Level Select] to select the voltage output and current output.

No.	Name	Range	Default
H4-02	Terminal FM Analog Output Gain	-999.9 - +999.9%	100.0%
H4-03	Terminal FM Analog Output Bias	-999.9 - +999.9%	0.0%
H4-05	Terminal AM Analog Output Gain	-999.9 - +999.9%	50.0%
H4-06	Terminal AM Analog Output Bias	-999.9 - +999.9%	0.0%
H4-07	Terminal FM Signal Level Select	0: 0 to 10 Vdc 1: -10 to +10 Vdc 2: 4 to 20 mA	0
H4-08	Terminal AM Signal Level Select	0: 0 to 10 Vdc 1: -10 to +10 Vdc 2: 4 to 20 mA	0

Figure 12.110 and Figure 12.111 show the gain and bias.

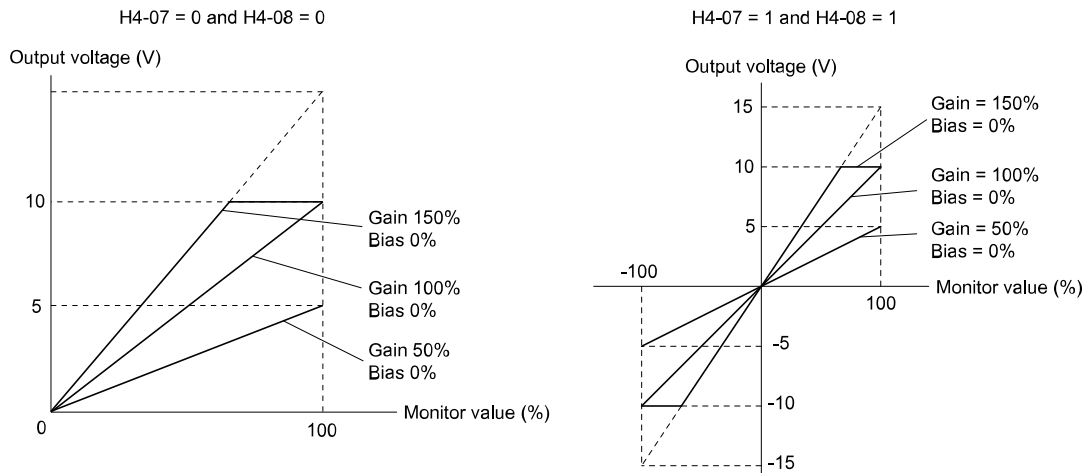

Figure 12.110 Analog Output Gain/Bias Configuration Example 1

For example, when the parameter value set to analog output is 0, and a 3 V signal is output to terminal FM, H4-03 [Terminal FM Analog Output Bias] is set to 30%.

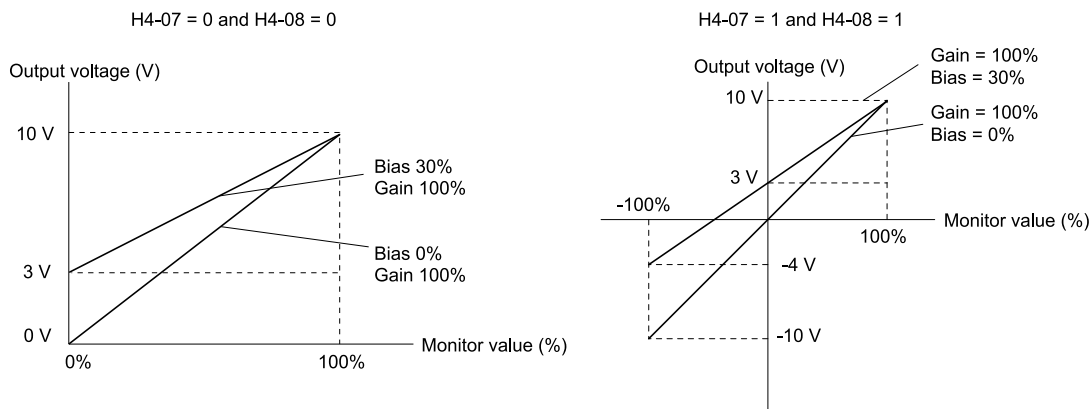

Figure 12.111 Analog Output Gain/Bias Configuration Example 2

Calibrate Terminal FM

Stop the drive to calibrate meters. Use this procedure to calibrate:

1. Show *H4-02 [Terminal FM Analog Output Gain]* on the keypad. Terminal FM outputs the analog signal when the monitor item that you set in *H4-01 [Terminal FM Analog Output Select]* is 100%.
2. Adjust *H4-02* while referencing the meter scale connected to terminal FM.
3. Show *H4-03 [Terminal FM Analog Output Bias]* on the keypad. Terminal FM outputs the analog signal when the monitor item that you set in *H4-01* is 0%.
4. Adjust *H4-03* while referencing the meter scale connected to terminal FM.

Calibrate Terminal AM

Stop the drive to calibrate meters. Use this procedure to calibrate:

1. Show *H4-05 [Terminal AM Analog Output Gain]* on the keypad. Terminal AM outputs the analog signal when the monitor item that you set in *H4-04 [Terminal AM Analog Output Select]* is 100%.
2. Adjust *H4-05* while referencing the meter scale connected to terminal AM.
3. Show *H4-06 [Terminal AM Analog Output Bias]* on the keypad. Terminal AM outputs the analog signal when the monitor item that you set in *H4-04* is 0%.
4. Adjust *H4-06* while referencing the meter scale connected to terminal AM.

H4-01: Terminal FM Analog Output Select

No. (Hex.)	Name	Description	Default (Range)
H4-01 (041D)	Terminal FM Analog Output Select	V/f CL-V/f OLV CLV AOLV OLV/PM AOLV/PM CLV/PM EZOLV Sets the monitor number to send from MFAO terminal FM.	102 (000 - 999)

Set the *x-xx* part of the *Ux-xx [Monitor]*. For example, set *H4-01 = 102* to monitor *U1-02 [Output Frequency]*.

Note:

- You cannot use all of the monitors in all of the control methods.
- When you use the terminal in through mode, set this parameter to *000* or *031*. You can set the terminal FM output level from the PLC through MEMOBUS/Modbus communications or the communication option.

H4-02: Terminal FM Analog Output Gain

No. (Hex.)	Name	Description	Default (Range)
H4-02 (041E) RUN	Terminal FM Analog Output Gain	V/f CL-V/f OLV CLV AOLV OLV/PM AOLV/PM CLV/PM EZOLV Sets the gain of the monitor signal that is sent from MFAO terminal FM.	100.0% (-999.9 - +999.9%)

The analog signal output from the FM terminal is a maximum of ± 10 V (or 20 mA). Select the signal level with *H4-07 [Terminal FM Signal Level Select]*.

■ H4-03: Terminal FM Analog Output Bias

No. (Hex.)	Name	Description	Default (Range)
H4-03 (041F) RUN	Terminal FM Analog Output Bias	V/f CL-V/f OLV CLV AOLV OLV/PM AOLV/PM CLV/PM EZOLV Sets the bias of the monitor signal that is sent from MFAO terminal FM.	0.0% (-999.9 - +999.9%)

The analog signal output from the FM terminal is a maximum of ± 10 V (or 20 mA). Select the signal level with *H4-07 [Terminal FM Signal Level Select]*.

■ H4-04: Terminal AM Analog Output Select

No. (Hex.)	Name	Description	Default (Range)
H4-04 (0420)	Terminal AM Analog Output Select	V/f CL-V/f OLV CLV AOLV OLV/PM AOLV/PM CLV/PM EZOLV Sets the monitoring number to be output from the MFAO terminal AM.	103 (000 - 999)

Set the *x-xx* part of the *Ux-xx [Monitor]*. For example, set *H4-04 = 103* to monitor *U1-03 [Output Current]*.

Note:

- You cannot use all of the monitors in all of the control methods.
- When you use the terminal in through mode, set this parameter to *000* or *031*. You can set the terminal AM output level from the PLC through MEMOBUS/Modbus communications or the communication option.

■ H4-05: Terminal AM Analog Output Gain

No. (Hex.)	Name	Description	Default (Range)
H4-05 (0421) RUN	Terminal AM Analog Output Gain	V/f CL-V/f OLV CLV AOLV OLV/PM AOLV/PM CLV/PM EZOLV Sets the gain of the monitor signal that is sent from MFAO terminal AM.	50.0% (-999.9 - +999.9%)

The analog signal output from the AM terminal is a maximum of ± 10 V (or 20 mA). Select the signal level with *H4-08 [Terminal AM Signal Level Select]*.

Examples of possible settings:

When the output current of a monitoring item is 100% (drive rated current) in these examples, the voltage of AM terminal outputs at 5 V (50% of 10 V). Subsequently, the output current at the time the AM terminal outputs a maximum voltage of 10 V will be 200% of the drive rated current.

- *H4-04 = 103 [Terminal AM Analog Output Select = Output Current]*
- *H4-05 = 50.0%*
- *H4-06 = 0.0% [Terminal AM Analog Output Bias = 0.0%]*
- *H4-08 = 0 [0 to 10 V]*

■ H4-06: Terminal AM Analog Output Bias

No. (Hex.)	Name	Description	Default (Range)
H4-06 (0422) RUN	Terminal AM Analog Output Bias	V/f CL-V/f OLV CLV AOLV OLV/PM AOLV/PM CLV/PM EZOLV Sets the bias of the monitor signal that is sent from MFAO terminal AM.	0.0% (-999.9 - +999.9%)

The analog signal output from the AM terminal is a maximum of ± 10 V (or 20 mA). Select the signal level with *H4-08 [Terminal AM Signal Level Select]*.

■ H4-07: Terminal FM Signal Level Select

No. (Hex.)	Name	Description	Default (Range)
H4-07 (0423)	Terminal FM Signal Level Select	V/f CL-V/f OLV CLV AOLV OLV/PM AOLV/PM CLV/PM EZOLV Sets the MFAO terminal FM output signal level.	0 (0 - 2)

Note:

Set jumper S5 on the control circuit terminal block accordingly when changing these parameters.

0 : 0-10 VDC

1 : -10 +10 VDC

2 : 4-20 mA

■ H4-08: Terminal AM Signal Level Select

No. (Hex.)	Name	Description	Default (Range)
H4-08 (0424)	Terminal AM Signal Level Select	<div style="display: flex; justify-content: space-between; align-items: center;"> V/f CL-V/f OLV CLV AOLV OLV/PM AOLV/PM CLV/PM EZOLV </div> Sets the MFAO terminal AM output signal level.	0 (0 - 2)

Note:

Set jumper S5 on the terminal board to the correct position after changing this parameter.

0 : 0-10 VDC

1 : -10 +10 VDC

2 : 4-20 mA

■ H4-20: Analog Power Monitor 100% Level

No. (Hex.)	Name	Description	Default (Range)
H4-20 (0B53)	Analog Power Monitor 100% Level	<div style="display: flex; justify-content: space-between; align-items: center;"> V/f CL-V/f OLV CLV AOLV OLV/PM AOLV/PM CLV/PM EZOLV </div> Sets the level at 10 V when U1-08 [Output Power] is set for analog output.	0.00 kW (0.00 - 650.00 kW)

Note:

• When H4-20 = 0.00 kW, the output power monitor 10 V level = motor rated power. The setting changes when the A1-02 [Control Method Selection] value changes:

–A1-02 = 0, 1 [V/f, CL-V/f]: E2-11 [Motor Rated Power]

–A1-02 = 2, 3, 4 [OLV, CLV, AOLV]: E2-11 [Motor Rated Power]

–A1-02 = 5, 6, 7 [OLV/PM, AOLV/PM, CLV/PM]: E5-02 [PM Motor Rated Power]

–A1-02 = 8 [EZOLV]: E9-07 [Motor Rated Power]

◆ H5: Memobus/Modbus Communication

H5 parameters configure the drive to use MEMOBUS/Modbus communications.

You can use the MEMOBUS/Modbus protocol over the RS-485 port (terminals D+ and D-) in the drive to use serial communication with programmable controllers (PLC).

■ H5-01: Drive Node Address

No. (Hex.)	Name	Description	Default (Range)
H5-01 (0425)	Drive Node Address	<div style="display: flex; justify-content: space-between; align-items: center;"> V/f CL-V/f OLV CLV AOLV OLV/PM AOLV/PM CLV/PM EZOLV </div> Sets the communication slave address for drives.	1FH (0 - FFH)

Note:

• Restart the drive after changing the parameter setting.

• Setting 0 will not let the drive respond to MEMOBUS/Modbus communications.

To enable the drive to communicate with the controller (master) over MEMOBUS/Modbus communications, you must set the drive with a slave address. Set H5-01 ≠ 0.

Set a slave address that is different from other slave devices.

■ H5-02: Communication Speed Selection

No. (Hex.)	Name	Description	Default (Range)
H5-02 (0426)	Communication Speed Selection	<div style="display: flex; justify-content: space-between; font-size: small;"> V/f CL-V/f OLV CLV AOLV OLV/PM AOLV/PM CLV/PM EZOLV </div> Sets the communications speed for MEMOBUS/Modbus communications.	3 (0 - 8)

Note:

Restart the drive after you change the parameter setting.

- 0 : 1200 bps**
- 1 : 2400 bps**
- 2 : 4800 bps**
- 3 : 9600 bps**
- 4 : 19.2 kbps**
- 5 : 38.4 kbps**
- 6 : 57.6 kbps**
- 7 : 76.8 kbps**
- 8 : 115.2 kbps**

■ H5-03: Communication Parity Selection

No. (Hex.)	Name	Description	Default (Range)
H5-03 (0427)	Communication Parity Selection	<div style="display: flex; justify-content: space-between; font-size: small;"> V/f CL-V/f OLV CLV AOLV OLV/PM AOLV/PM CLV/PM EZOLV </div> Sets the communications parity used for MEMOBUS/Modbus communications.	0 (0 - 2)

Note:

Restart the drive after you change the parameter setting.

- 0 : No parity**
- 1 : Even parity**
- 2 : Odd parity**

■ H5-04: Communication Error Stop Method

No. (Hex.)	Name	Description	Default (Range)
H5-04 (0428)	Communication Error Stop Method	<div style="display: flex; justify-content: space-between; font-size: small;"> V/f CL-V/f OLV CLV AOLV OLV/PM AOLV/PM CLV/PM EZOLV </div> Sets the motor Stopping Method when the drive detects <i>CE [Modbus Communication Error]</i> issues.	3 (0 - 3)

0 : Ramp to Stop

The drive ramps the motor to stop in the deceleration time. Fault relay output terminal MA-MC turns ON, and MB-MC turns OFF.

1 : Coast to Stop

The output turns off and the motor coasts to stop. Fault relay output terminal MA-MC turns ON, and MB-MC turns OFF.

2 : Fast Stop (Use C1-09)

The drive stops the motor in the deceleration time set in *C1-09 [Fast Stop Time]*. Fault relay output terminal MA-MC turns ON, and MB-MC turns OFF.

3 : Alarm Only

The keypad shows *CE* and the drive continues operation. The output terminal set for *Alarm [H2-01 to H2-03 = 10]* activates.

■ H5-05: Comm Fault Detection Selection

No. (Hex.)	Name	Description	Default (Range)
H5-05 (0429)	Comm Fault Detection Selection	<div style="display: flex; justify-content: space-between; font-size: small;"> V/f CL-V/f OLV CLV AOLV OLV/PM AOLV/PM CLV/PM EZOLV </div> Sets the function that detects <i>CE</i> [Modbus Communication Error] issues during MEMOBUS/Modbus communications.	1 (0, 1)

If the drive does not receive data from the master during the time set in *H5-09* [*CE Detection Time*], it will detect a *CE* error.

0 : Disabled

Does not detect *CE*. The drive continues operation.

1 : Enabled

Detects *CE*. If the drive detects *CE*, it will operate as specified by the setting of *H5-04* [*Communication Error Stop Method*].

■ H5-06: Drive Transmit Wait Time

No. (Hex.)	Name	Description	Default (Range)
H5-06 (042A)	Drive Transmit Wait Time	<div style="display: flex; justify-content: space-between; font-size: small;"> V/f CL-V/f OLV CLV AOLV OLV/PM AOLV/PM CLV/PM EZOLV </div> Sets the time to wait to send a response message after the drive receives a command message from the master.	5 ms (0 - 65 ms)

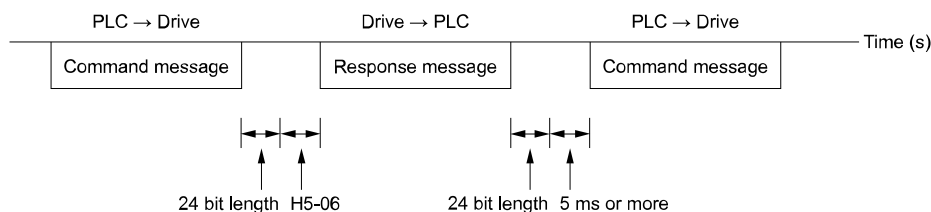

Figure 12.112 Drive Transmit Wait Time

■ H5-09: CE Detection Time

No. (Hex.)	Name	Description	Default (Range)
H5-09 (0435)	CE Detection Time	<div style="display: flex; justify-content: space-between; font-size: small;"> V/f CL-V/f OLV CLV AOLV OLV/PM AOLV/PM CLV/PM EZOLV </div> Sets the detection time for <i>CE</i> [Modbus Communication Error] issues when communication stops.	2.0 s (0.0 - 10.0 s)

■ H5-10: Modbus Register 0025H Unit Sel

No. (Hex.)	Name	Description	Default (Range)
H5-10 (0436)	Modbus Register 0025H Unit Sel	<div style="display: flex; justify-content: space-between; font-size: small;"> V/f CL-V/f OLV CLV AOLV OLV/PM AOLV/PM CLV/PM EZOLV </div> Sets the unit of measure used for the MEMOBUS/Modbus communications monitor register 0025H (output voltage reference monitor).	0 (0, 1)

0 : 0.1 V units

1 : 1 V units

■ H5-11: Comm ENTER Command Mode

No. (Hex.)	Name	Description	Default (Range)
H5-11 (043C)	Comm ENTER Command Mode	<div style="display: flex; justify-content: space-between; font-size: small;"> V/f CL-V/f OLV CLV AOLV OLV/PM AOLV/PM CLV/PM EZOLV </div> Sets the function to make the Enter command necessary to change parameters through MEMOBUS/Modbus communications.	0 (0, 1)

0 : ENTER Command Required

You must use the Enter command to enable changes to parameters. Make all parameter changes then input the Enter command.

1 : ENTER Command Not Required

It is not necessary to input the Enter command to change parameters.

■ H5-12: Run Command Method Selection

No. (Hex.)	Name	Description	Default (Range)
H5-12 (043D)	Run Command Method Selection	<p>V/f CL-V/f OLV CLV AOLV OLV/PM AOLV/PM CLV/PM EZOLV</p> <p>Sets the input method for the Run command when <i>b1-02 = 2</i> [Run Command Selection 1 = Memobus/Modbus Communications] or <i>b1-16 = 2</i> [Run Command Selection 2 = Memobus/Modbus Communications].</p>	0 (0, 1)

0 : FWD/Stop, REV/Stop

The drive uses bit 0 in command data 0001H of the MEMOBUS register in the motor forward Run command (bit 0 = 1) and the stop command (bit 0 = 0). The drive uses bit 1 in the motor reverse Run command (bit 1 = 1) and the stop command (bit 1 = 0).

1 : Run/Stop, FWD/REV

The drive uses bit 0 in command data 0001H of the MEMOBUS register in the motor Run command (bit 0 = 1) and the stop command (bit 0 = 0). The drive uses bit 1 in the direction of motor rotation command (Forward run (bit1 = 0) or Reverse run (bit 1 = 1)).

■ H5-17: ENTER command response @CPU BUSY

No. (Hex.)	Name	Description	Default (Range)
H5-17 (11A1) Expert	ENTER command response @CPU BUSY	<p>V/f CL-V/f OLV CLV AOLV OLV/PM AOLV/PM CLV/PM EZOLV</p> <p>Sets operation when the EEPROM write command is sent without EEPROM write available. Usually it is not necessary to change this setting.</p>	0 (0, 1)

0 : Ignore Command(No ROM/RAM Write)

1 : Write to RAM Only

■ H5-18: Motor Speed Filter over Comms

No. (Hex.)	Name	Description	Default (Range)
H5-18 (11A2)	Motor Speed Filter over Comms	<p>V/f CL-V/f OLV CLV AOLV OLV/PM AOLV/PM CLV/PM EZOLV</p> <p>Sets the filter time constant used when monitoring motor speed during MEMOBUS/Modbus communications or with a communication option.</p>	0 ms (0 - 100 ms)

Sets the filter time constant when you monitor the output frequency or motor speed during MEMOBUS/Modbus communications or use of the communication option.

These are the MEMOBUS registers:

- 003EH (Output Frequency)
- 003FH (Output Frequency)
- 0044H (UI-05: Motor Speed)
- 00ACH (UI-05: Motor Speed)
- 00ADH (UI-05: Motor Speed)

■ H5-20: Communication Parameters Reload

No. (Hex.)	Name	Description	Default (Range)
H5-20 (0B57)	Communication Parameters Reload	<p>V/f CL-V/f OLV CLV AOLV OLV/PM AOLV/PM CLV/PM EZOLV</p> <p>Sets the function to immediately enable updated MEMOBUS/Modbus communications parameters.</p>	0 (0, 1)

0 : Reload at Next Power Cycle

1 : Reload Now

Note:

- The setting value automatically returns to $H5-20 = 0$ after you enable MEMOBUS/Modbus communications parameter changes.
- The setting values of these parameters are enabled:
 - H5-01 [Drive Node Address]
 - H5-02 [Communication Speed Selection]
 - H5-03 [Communication Parity Selection]
 - H5-06 [Drive Transmit Wait Time]

■ H5-22: Speed Search from MODBUS

No. (Hex.)	Name	Description	Default (Range)
H5-22 (11CF)	Speed Search from MODBUS	<div style="display: flex; justify-content: space-between; gap: 5px;"> V/f CL-V/f OLV CLV AOLV OLV/PM AOLV/PM CLV/PM EZOLV </div> Enables the MEMOBUS/Modbus communication register Speed Search function (bit0 of 15DFH).	0 (0, 1)

0 : Disabled

1 : Enabled

If you set $H5-22 = 1$ and $H1-xx = 62$ [Speed Search from Fref] at the same time, the drive will detect *oPE03* [Multi-Function Input Setting Err].

■ H5-25: Function 5A Register 1 Selection

No. (Hex.)	Name	Description	Default (Range)
H5-25 (1589) RUN	Function 5A Register 1 Selection	<div style="display: flex; justify-content: space-between; gap: 5px;"> V/f CL-V/f OLV CLV AOLV OLV/PM AOLV/PM CLV/PM EZOLV </div> Returns the contents of the specified MEMOBUS/Modbus communications register when responding to the master device.	0044H (U1-05) (0000H - FFFFH)

■ H5-26: Function 5A Register 2 Selection

No. (Hex.)	Name	Description	Default (Range)
H5-26 (158A) RUN	Function 5A Register 2 Selection	<div style="display: flex; justify-content: space-between; gap: 5px;"> V/f CL-V/f OLV CLV AOLV OLV/PM AOLV/PM CLV/PM EZOLV </div> Returns the contents of the specified MEMOBUS/Modbus communications register when responding to the master device.	0045H (U1-06) (0000H - FFFFH)

■ H5-27: Function 5A Register 3 Selection

No. (Hex.)	Name	Description	Default (Range)
H5-27 (158B) RUN	Function 5A Register 3 Selection	<div style="display: flex; justify-content: space-between; gap: 5px;"> V/f CL-V/f OLV CLV AOLV OLV/PM AOLV/PM CLV/PM EZOLV </div> Returns the contents of the specified MEMOBUS/Modbus communications register when responding to the master device.	0042H (U1-03) (0000H - FFFFH)

■ H5-28: Function 5A Register 4 Selection

No. (Hex.)	Name	Description	Default (Range)
H5-28 (158C) RUN	Function 5A Register 4 Selection	<div style="display: flex; justify-content: space-between; gap: 5px;"> V/f CL-V/f OLV CLV AOLV OLV/PM AOLV/PM CLV/PM EZOLV </div> Returns the contents of the specified MEMOBUS/Modbus communications register when responding to the master device.	0049H (U1-10) (0000H - FFFFH)

◆ H6: Pulse Train Input/Output

H6 parameters set the drive pulse train input and pulse train monitor. These parameters select input and monitor parameters and adjust the pulse train frequency.

A pulse train signal with a maximum single pulse of 32 kHz can be input to the drive input terminal RP. You can use the pulse train signal as the frequency reference, PID feedback value, PID setpoint value, and speed feedback for V/f Control mode.

A pulse train signal with a maximum frequency of 32 kHz can be output from the drive output terminal MP as the monitor value. Sinking mode and sourcing mode are supported.

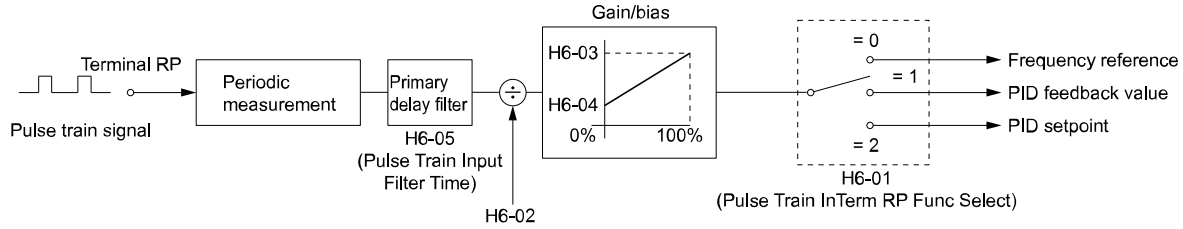

Figure 12.113 Pulse Train Input Block Diagram

■ H6-01: Terminal RP Pulse Train Function

No. (Hex.)	Name	Description	Default (Range)
H6-01 (042C)	Terminal RP Pulse Train Function	V/f CL-V/f OLV CLV AOLV OLV/PM AOLV/PM CLV/PM EZOLV Sets the function for pulse train input terminal RP.	0 (0 - 3)

0 : Frequency Reference

When *b1-01 [Frequency Reference Selection 1]* or *b1-15 [Frequency Reference Selection 2] = 4 [Pulse Train Input]*, the drive inputs the frequency reference received from terminal RP.

1 : PID Feedback Value

The drive inputs the PID control feedback value received from terminal RP.

2 : PID Setpoint Value

The drive inputs the PID control target value received from terminal RP.

3 : Speed Feedback (V/F Control)

Select V/f Control method to enable simple encoder feedback.

Use motor speed feedback for better speed control precision. The drive compares the frequency reference to the motor speed feedback received from the encoder, and uses the ASR function to compensates for motor slip. You cannot use input terminal RP used for the simple encoder to detect the direction of motor rotation. Use a different method to detect motor rotation.

Use these methods to detect the direction of motor rotation.

- Use MFDI
 Set *MFDI H1-xx = 7E [Reverse Rotation Identifier]*. When the configured terminal is activated, the motor operates in Reverse run. When the terminal is deactivated, the motor operates in Forward run.
 Use an encoder that outputs 2-tracks (phase A, B) to detect the direction of motor rotation.
- Use the frequency reference
 When the you do not use the MFDI, the Forward/Reverse run command is the same as the direction of motor rotation.

Figure 12.114 shows speed control in Simple Closed Loop V/f Mode.

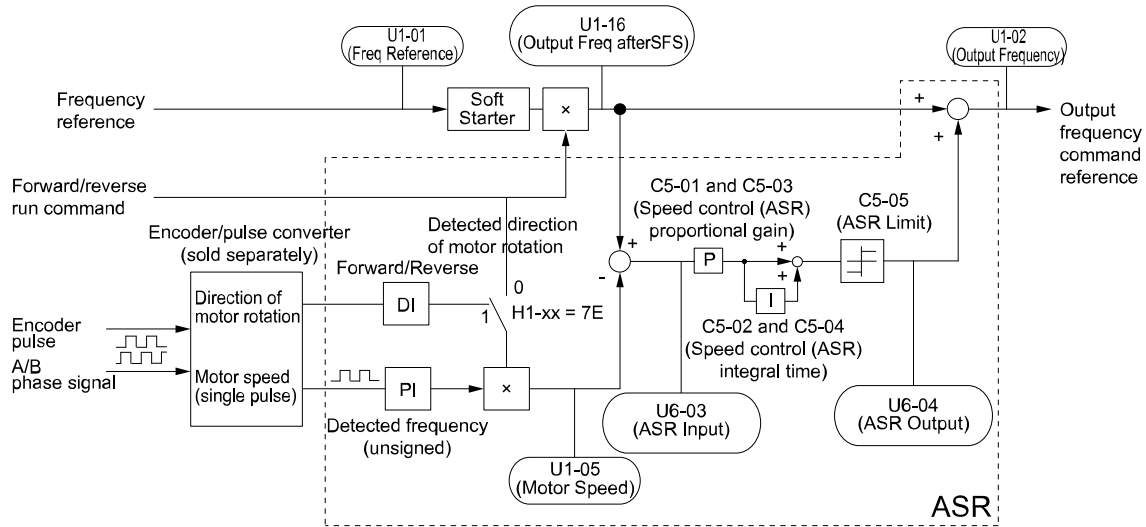

Figure 12.114 Simple Closed Loop Speed Control Block Diagram

Enable Simple Closed Loop V/f Mode

1. Connect the encoder output pulse wiring to terminal RP.
2. Set $A1-02 = 0$ [Control Method Selection = V/f Control].
3. Set $H6-01 = 3$.
4. Set $H6-02$ [Terminal RP Frequency Scaling] to the speed feedback (pulse train input signal) frequency at the time when the frequency reference is 100%.
Make sure that $H6-04$ [Terminal RP Function Bias] = 0% and $H6-03$ [Terminal RP Function Gain] = 100%.
5. Select the detection method for the direction of motor rotation.
When you use an MFDI, set $H1-xx = 7E$.
6. Set $C5$ parameters related to ASR gain and integral time to adjust responsiveness.

Note:

- Set $A1-02 = 0$ and $H6-01 = 3$ to show $C5$ parameters.
- You cannot use Closed Loop V/f Control mode with the Motor Switch function.

H6-02: Terminal RP Frequency Scaling

No. (Hex.)	Name	Description	Default (Range)
H6-02 (042D) RUN	Terminal RP Frequency Scaling	<div style="display: flex; justify-content: space-between; font-size: small;"> V/f CL-V/f OLV CLV AOLV OLV/PM AOLV/PM CLV/PM EZOLV </div> <p>Sets the frequency of the pulse train input signal used when the item selected with $H6-01$ [Terminal RP Pulse Train Function] is input at 100%.</p>	1440 Hz (100 - 32000 Hz)

H6-03: Terminal RP Function Gain

No. (Hex.)	Name	Description	Default (Range)
H6-03 (042E) RUN	Terminal RP Function Gain	<div style="display: flex; justify-content: space-between; font-size: small;"> V/f CL-V/f OLV CLV AOLV OLV/PM AOLV/PM CLV/PM EZOLV </div> <p>Sets the gain used when the function in $H6-01$ [Terminal RP Pulse Train Function] is input to terminal RP.</p>	100.0% (0.0 - 1000.0%)

H6-04: Terminal RP Function Bias

No. (Hex.)	Name	Description	Default (Range)
H6-04 (042F) RUN	Terminal RP Function Bias	<div style="display: flex; justify-content: space-between; font-size: small;"> V/f CL-V/f OLV CLV AOLV OLV/PM AOLV/PM CLV/PM EZOLV </div> <p>Sets the bias used when the function in $H6-01$ [Terminal RP Pulse Train Function] is input to terminal RP. Sets a value at the time when the pulse train is 0 Hz.</p>	0.0% (-100.0 - 100.0%)

■ H6-05: Terminal RP Filter Time

No. (Hex.)	Name	Description	Default (Range)
H6-05 (0430) RUN	Terminal RP Filter Time	V/f CL-V/f OLV CLV AOLV OLV/PM AOLV/PM CLV/PM EZOLV Sets the time constant for the pulse train input primary delay filters.	0.10 s (0.00 - 2.00 s)

■ H6-06: Terminal MP Monitor Selection

No. (Hex.)	Name	Description	Default (Range)
H6-06 (0431) RUN	Terminal MP Monitor Selection	V/f CL-V/f OLV CLV AOLV OLV/PM AOLV/PM CLV/PM EZOLV Sets a function for pulse train monitor output terminal MP. Sets the "x-xx" part of the $Ux-xx$ monitor.	102 (000, 031, 101, 102, 105, 116, 501, 502, 801 - 809, 821 - 825, 831 - 839, 851 - 855)

Note:

To use in through mode or when terminal MP is not used, set this parameter to 000 or 031.

When you use the pulse train monitor, make sure that you connect peripheral devices as specified by these load conditions:

Incorrect connections can make the characteristics not sufficient or cause mechanical damage.

- Use the pulse train monitor as the sourcing output.

Output Voltage VRL(V)	Load Impedance (kΩ)
5 V or more	1.5 kΩ or more
8 V or more	4.0 kΩ or more
10 V or more	10 kΩ or more

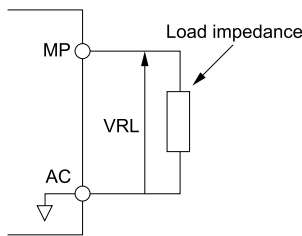

Figure 12.115 Circuit Diagram When Used as the Sourcing Output

- Use the pulse train monitor as the sinking input

External Power Supply (V)	12 VDC ± 10%, 15 VDC ± 10%
Sinking current (mA)	16 mA or less

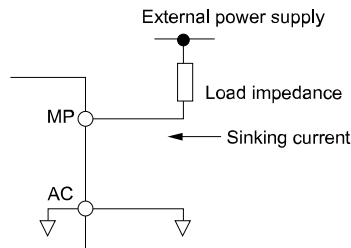

Figure 12.116 Circuit Diagram When Used as the Sinking Input

■ H6-07: Terminal MP Frequency Scaling

No. (Hex.)	Name	Description	Default (Range)
H6-07 (0432) RUN	Terminal MP Frequency Scaling	<div style="display: flex; justify-content: space-between; font-size: small;"> V/f CL-V/f OLV CLV AOLV OLV/PM AOLV/PM CLV/PM EZOLV </div> Sets the frequency of the pulse train output signal used when the monitor set with H6-06 [Terminal MP Monitor Selection] is 100%.	1440 Hz (0 - 32000 Hz)

When H6-06 = 102 [Terminal MP Monitor Selection = Output Frequency] and H6-07 = 0, the pulse train output terminal MP outputs the same frequency as the drive output frequency.

■ H6-08: Terminal RP Minimum Frequency

No. (Hex.)	Name	Description	Default (Range)
H6-08 (043F)	Terminal RP Minimum Frequency	<div style="display: flex; justify-content: space-between; font-size: small;"> V/f CL-V/f OLV CLV AOLV OLV/PM AOLV/PM CLV/PM EZOLV </div> Sets the minimum frequency of the pulse train signal that terminal RP can detect.	0.5 Hz (0.1 - 1000.0 Hz)

- When you input a pulse train frequency that is less than the value of H6-08, the pulse train input is 0.0 Hz.
- Set H6-01 [Terminal RP Pulse Train Function] = 0 [Frequency Reference], 1 [PID Feedback Value], or 2 [PID Setpoint Value] to enable this parameter.
- When H6-01 = 3 [Speed Feedback (V/F Control)], the drive applies the setting of F1-14 [Encoder Open-Circuit Detect Time] to the minimum frequency.

■ H6-09: Voltage Phase Sync MP Selection

No. (Hex.)	Name	Description	Default (Range)
H6-09 (156E)	Voltage Phase Sync MP Selection	<div style="display: flex; justify-content: space-between; font-size: small;"> V/f CL-V/f OLV CLV AOLV OLV/PM AOLV/PM CLV/PM EZOLV </div> Set whether to output the pulse synchronized with drive output voltage phase from the pulse train monitor output terminal MP. This parameter is only enabled when H6-06 = 102 [Terminal MP Monitor Selection = Output Frequency] and H6-07 = 0 [Terminal MP Frequency Scaling = 0 Hz].	0 (0, 1)

0 : Disabled

1 : Enabled

◆ H7: Virtual MFIO Selection

The virtual I/O function performs the following.

- Inputs the result of the output from the MFDO terminal to the MFDI terminal without external wiring.
- Inputs the result of the output from the MFAO terminal to the MFAI terminal without external wiring.

WARNING! Sudden Movement Hazard. Before you do a test run, make sure that the setting values for virtual input and output function parameters are correct. Virtual input and output functions can have different default settings and operation than wired input and output functions. Incorrect function settings can cause serious injury or death.

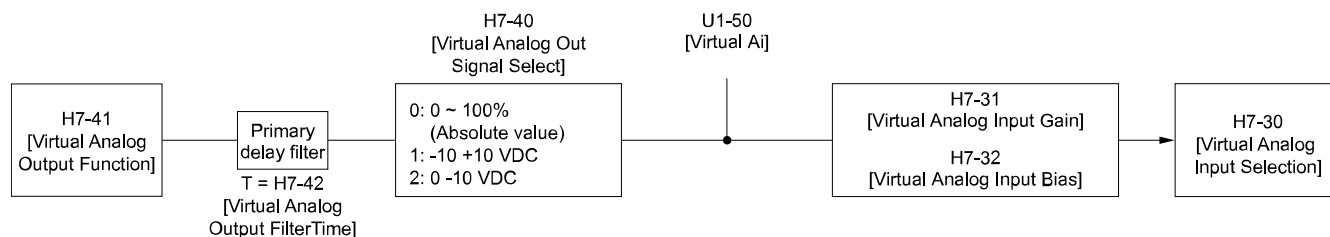

Figure 12.117 Virtual Analog I/O Functional Block Diagram

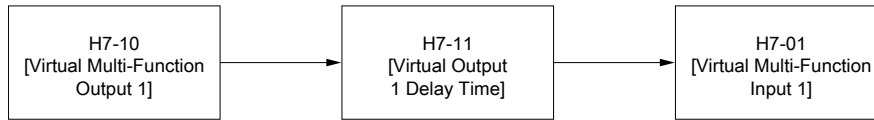

Figure 12.118 Virtual Digital I/O Functional Block Diagram

Note:

- Refer to H1-xx "MFDI Setting Values" for more information on the virtual digital input setting values.
- Refer to H2-xx "MFDO Setting Values" for more information on the virtual digital output setting values.
- Refer to H3-xx "MFAI Setting Values" for more information on the virtual analog input setting values.
- Refer to H4-xx "MFAO Setting Values" for more information on the virtual analog output setting values.
- You cannot set 0 [3-Wire Sequence] and 20 or 2F [External Fault] to H7-01 to H7-04 [Virtual Multi-Function Input 1 to 4].
- If the terminal is not used, set H7-01 to H7-04 = F. The through mode function is not supported.
- The virtual I/O function selection and the multi-function input for DI-A3 cannot be used simultaneously.

■ **H7-00: Virtual MFIO selection**

No. (Hex.)	Name	Description	Default (Range)
H7-00 (116F) Expert	Virtual MFIO selection	<div style="display: flex; justify-content: space-between; font-size: small;"> V/f CL-V/f OLV CLV AOLV OLV/PM AOLV/PM CLV/PM EZOLV </div> <p>Sets the function to enable and disable the virtual I/O function. Set this parameter to 1 to operate the virtual I/O function.</p>	0 (0, 1)

0 : Disabled

1 : Enabled

■ **H7-01: Virtual Multi-Function Input 1**

No. (Hex.)	Name	Description	Default (Range)
H7-01 (1185) Expert	Virtual Multi-Function Input 1	<div style="display: flex; justify-content: space-between; font-size: small;"> V/f CL-V/f OLV CLV AOLV OLV/PM AOLV/PM CLV/PM EZOLV </div> <p>Sets the function that enters the virtual input set in H7-10 [Virtual Multi-Function Output 1].</p>	F (1 - 19F)

Note:

Settings 1B [Programming Lockout] and 11B [!Programming Lockout] are not available.

■ **H7-02: Virtual Multi-Function Input 2**

No. (Hex.)	Name	Description	Default (Range)
H7-02 (1186) Expert	Virtual Multi-Function Input 2	<div style="display: flex; justify-content: space-between; font-size: small;"> V/f CL-V/f OLV CLV AOLV OLV/PM AOLV/PM CLV/PM EZOLV </div> <p>Sets the function that enters the virtual input set in H7-12 [Virtual Multi-Function Output 2].</p>	F (1 - 19F)

Note:

Settings 1B [Programming Lockout] and 11B [!Programming Lockout] are not available.

■ **H7-03: Virtual Multi-Function Input 3**

No. (Hex.)	Name	Description	Default (Range)
H7-03 (1187) Expert	Virtual Multi-Function Input 3	<div style="display: flex; justify-content: space-between; font-size: small;"> V/f CL-V/f OLV CLV AOLV OLV/PM AOLV/PM CLV/PM EZOLV </div> <p>Sets the function that enters the virtual input set in H7-14 [Virtual Multi-Function Output 3].</p>	F (1 - 19F)

Note:

Settings 1B [Programming Lockout] and 11B [!Programming Lockout] are not available.

■ H7-04: Virtual Multi-Function Input 4

No. (Hex.)	Name	Description	Default (Range)
H7-04 (1188) Expert	Virtual Multi-Function Input 4	<div style="display: flex; justify-content: space-between; gap: 5px;"> V/f CL-V/f OLV CLV AOLV OLV/PM AOLV/PM CLV/PM EZOLV </div> Sets the function that enters the virtual input set in H7-16 [Virtual Multi-Function Output 4].	F (1 - 19F)

Note:

Settings 1B [Programming Lockout] and 11B [!Programming Lockout] are not available.

■ H7-10: Virtual Multi-Function Output 1

No. (Hex.)	Name	Description	Default (Range)
H7-10 (11A4) Expert	Virtual Multi-Function Output 1	<div style="display: flex; justify-content: space-between; gap: 5px;"> V/f CL-V/f OLV CLV AOLV OLV/PM AOLV/PM CLV/PM EZOLV </div> Sets the function for virtual digital output 1.	F (0 - 1A7)

■ H7-11: Virtual Output 1 Delay Time

No. (Hex.)	Name	Description	Default (Range)
H7-11 (11A5) Expert	Virtual Output 1 Delay Time	<div style="display: flex; justify-content: space-between; gap: 5px;"> V/f CL-V/f OLV CLV AOLV OLV/PM AOLV/PM CLV/PM EZOLV </div> Sets the minimum ON time for virtual digital output 1.	0.1 s (0.0 - 25.0 s)

■ H7-12: Virtual Multi-Function Output 2

No. (Hex.)	Name	Description	Default (Range)
H7-12 (11A6) Expert	Virtual Multi-Function Output 2	<div style="display: flex; justify-content: space-between; gap: 5px;"> V/f CL-V/f OLV CLV AOLV OLV/PM AOLV/PM CLV/PM EZOLV </div> Sets the function for virtual digital output 2.	F (0 - 1A7)

■ H7-13: Virtual Output 2 Delay Time

No. (Hex.)	Name	Description	Default (Range)
H7-13 (11A7) Expert	Virtual Output 2 Delay Time	<div style="display: flex; justify-content: space-between; gap: 5px;"> V/f CL-V/f OLV CLV AOLV OLV/PM AOLV/PM CLV/PM EZOLV </div> Sets the minimum ON time for virtual digital output 2.	0.1 s (0.0 - 25.0 s)

■ H7-14: Virtual Multi-Function Output 3

No. (Hex.)	Name	Description	Default (Range)
H7-14 (11A8) Expert	Virtual Multi-Function Output 3	<div style="display: flex; justify-content: space-between; gap: 5px;"> V/f CL-V/f OLV CLV AOLV OLV/PM AOLV/PM CLV/PM EZOLV </div> Sets the function for virtual digital output 3.	F (0 - 1A7)

■ H7-15: Virtual Output 3 Delay Time

No. (Hex.)	Name	Description	Default (Range)
H7-15 (11A9) Expert	Virtual Output 3 Delay Time	<div style="display: flex; justify-content: space-between; gap: 5px;"> V/f CL-V/f OLV CLV AOLV OLV/PM AOLV/PM CLV/PM EZOLV </div> Sets the minimum ON time for virtual digital output 3.	0.1 s (0.0 - 25.0 s)

■ H7-16: Virtual Multi-Function Output 4

No. (Hex.)	Name	Description	Default (Range)
H7-16 (11AA) Expert	Virtual Multi-Function Output 4	V/f CL-V/f OLV CLV AOLV OLV/PM AOLV/PM CLV/PM EZOLV Sets the function for virtual digital output 4.	F (0 - 1A7)

■ H7-17: Virtual Output 4 Delay Time

No. (Hex.)	Name	Description	Default (Range)
H7-17 (11AB) Expert	Virtual Output 4 Delay Time	V/f CL-V/f OLV CLV AOLV OLV/PM AOLV/PM CLV/PM EZOLV Sets the minimum ON time for virtual digital output 4.	0.1 s (0.0 - 25.0 s)

■ H7-30: Virtual Analog Input Selection

No. (Hex.)	Name	Description	Default (Range)
H7-30 (1177) Expert	Virtual Analog Input Selection	V/f CL-V/f OLV CLV AOLV OLV/PM AOLV/PM CLV/PM EZOLV Sets the virtual analog input function.	F (0 - 32)

■ H7-31: Virtual Analog Input Gain

No. (Hex.)	Name	Description	Default (Range)
H7-31 (1178) RUN Expert	Virtual Analog Input Gain	V/f CL-V/f OLV CLV AOLV OLV/PM AOLV/PM CLV/PM EZOLV Sets the virtual analog input gain.	100.0% (-999.9 - 999.9%)

■ H7-32: Virtual Analog Input Bias

No. (Hex.)	Name	Description	Default (Range)
H7-32 (1179) RUN Expert	Virtual Analog Input Bias	V/f CL-V/f OLV CLV AOLV OLV/PM AOLV/PM CLV/PM EZOLV Sets the virtual analog input bias.	0.0% (-999.9 - 999.9%)

■ H7-40: Virtual Analog Out Signal Select

No. (Hex.)	Name	Description	Default (Range)
H7-40 (1163)	Virtual Analog Out Signal Select	V/f CL-V/f OLV CLV AOLV OLV/PM AOLV/PM CLV/PM EZOLV Sets the signal level of the virtual analog output.	0 (0 - 2)

0 : 0 to 100% (Absolute Value)

1 : -100 to 100%

2 : 0 to 100% (Lower Limit at 0)

■ H7-41: Virtual Analog Output Function

No. (Hex.)	Name	Description	Default (Range)
H7-41 (1164)	Virtual Analog Output Function	V/f CL-V/f OLV CLV AOLV OLV/PM AOLV/PM CLV/PM EZOLV Sets the monitor to be output from the virtual analog output.	102 (0 - 999)

Set the $x-xx$ part of the $Ux-xx$ [Monitor]. For example, set $H7-41 = 102$ to monitor $U1-02$ [Output Frequency].

■ H7-42: Virtual Analog Output FilterTime

No. (Hex.)	Name	Description	Default (Range)
H7-42 (1165)	Virtual Analog Output FilterTime	V/f CL-V/f OLV CLV AOLV OLV/PM AOLV/PM CLV/PM EZOLV Sets the time constant for a primary filter of the virtual analog output.	0.00 s (0.00 - 2.00 s)

12.9 L: Protection Functions

L parameters set the following functions.

- Motor Overload Protection
- Operation During Momentary Power Loss
- Stall Prevention
- Speed Detection
- Auto Restart
- Detection of Overtorque/Undertorque
- Torque Limit
- Hardware Protection

◆ L1: Motor Protection

L1 parameters set the motor overload protection function.

■ Motor Protection Using Positive Temperature Coefficient (PTC) Thermistors

The temperature resistance characteristics of three PTC thermistors in the motor stator winding protect the motor from overheating.

The PTC thermistor must have the characteristics shown in [Figure 12.119](#) for each motor phase.

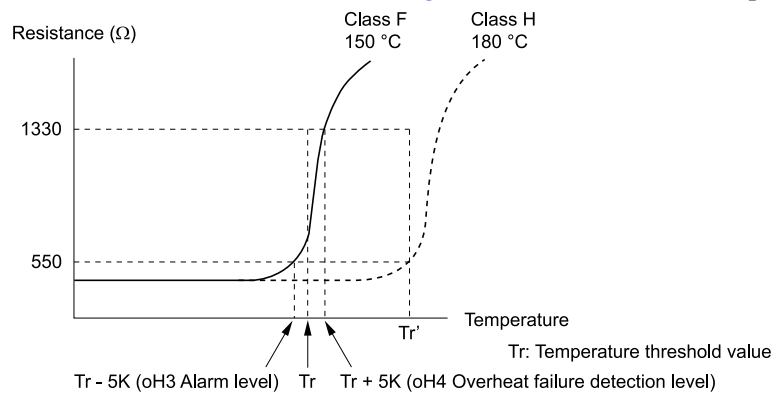

Figure 12.119 PTC Thermistor Temperature and Resistance

When the PTC input signal input to the drive is more than the overload alarm level, the drive detects *oH3* [*Motor Overheat (PTC Input)*]. The drive continues the operation set in *L1-03* [*Motor Thermistor oH Alarm Select*]. By factory default, *oH3* flashes on the keypad and the drive continues operation.

The overheat fault level triggers an *oH4* [*Motor Overheat Fault (PTC Input)*] fault, and outputs a fault signal. The drive outputs a fault signal, and uses the stop method set in *L1-04* [*Motor Thermistor oH Fault Select*] to stop the motor.

Note:

PTC is an acronym for Positive Temperature Coefficient.

[Figure 12.120](#) shows the configuration procedure when you use terminal A3.

1. Connect the PTC thermistor input from the motor to analog input terminal A3 on the drive.

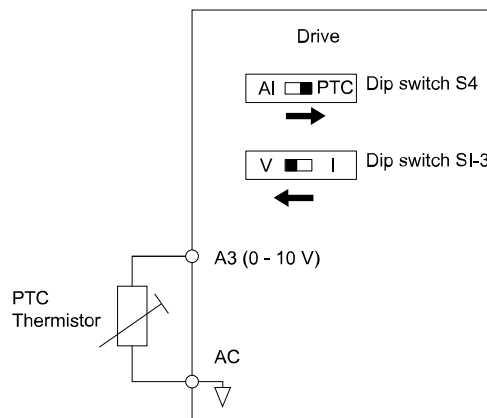

Figure 12.120 Connect Motor PTC

2. Set drive DIP switch S1-3 to V (voltage) and set DIP switch S4 to PTC.
3. Set these MFAI terminals:
 - Set $H3-05 = 0$ [Terminal A3 Signal Level Select = 0 to 10V (Lower Limit at 0)].
 - Set $H3-06 = E$ [Terminal A3 Function Selection = Motor Temperature (PTC input)].
4. Set these LI parameters:
 - $L1-03$ [Motor Thermistor oH Alarm Select]
 - $L1-04$ [Motor Thermistor oH Fault Select]
 - $L1-05$ [Motor Thermistor Filter Time]

■ L1-01: Motor Overload (oL1) Protection

No. (Hex.)	Name	Description	Default (Range)
L1-01 (0480)	Motor Overload (oL1) Protection	V/f CL-V/f OLV CLV AOLV OLVP/M AOLVP/M CLVP/M EZOLV Sets the motor overload protection with electronic thermal protectors.	Determined by A1-02 (0 - 6)

This parameter enables and disables the motor overload protection with electronic thermal protectors.

The cooling capability of the motor changes when the speed control range of the motor changes. Use an electronic thermal protector that aligns with the permitted load characteristics of the motor to select motor protection.

The electronic thermal protector of the drive uses these items to calculate motor overload tolerance and supply overload protection for the motor:

- Output Current
- Output Frequency
- Motor thermal characteristics
- Time characteristics

If the drive detects motor overload, the drive will trigger an $oL1$ [Motor Overload] and stop the drive output.

Set $H2-01 = 1F$ [Term M1-M2 Function Selection = Motor Overload Alarm (oL1)] to set a motor overload alarm. If the motor overload level is more than 90% of the $oL1$ detection level, the output terminal turns ON and triggers an overload alarm.

0 : Disabled

Disable motor protection when motor overload protection is not necessary or when the drive is operating more than one motor.

Refer to [Figure 12.121](#) for an example of the circuit configuration to connect more than one motor to one drive.

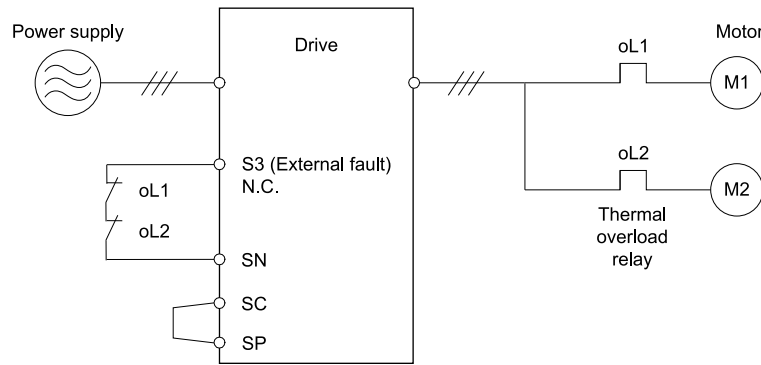

Figure 12.121 Protection Circuit Configuration to Connect More than One Motor to One Drive

NOTICE: When you connect more than one motor to one drive or when the motor amp rating is higher than the drive amp rating, set L1-01 = 0 [Motor Overload (oL1) Protection = Disabled] and install thermal overload relays for each motor. The electronic thermal protection of the drive will not function and it can cause damage to the motor.

1 : Variable Torque

Use this setting for general-purpose motors with a 60 Hz base frequency.

The overload tolerance decreases as motor speed decreases because the cooling fan speed decreases and the ability of the motor to cool decreases in the low speed range.

The overload tolerance characteristics of the motor change the trigger point for the electronic thermal protector. This provides motor overheat protection from low speed to high speed across the full speed range.

Load Tolerance	Cooling Capability	Overload Characteristics (at 100% motor load)
	<p>This motor is designed to operate with commercial line power. Operate at a 60 Hz base frequency to maximize the motor cooling ability.</p>	<p>If the motor operates at frequencies less than 60 Hz, the drive will detect oL1. The drive triggers a fault relay output and the motor coasts to stop.</p>

2 : Constant Torque 10:1 Speed Range

Use this setting for drive-dedicated motors with a speed range for constant torque of 1:10.

The speed control for this motor is 10% to 100% when at 100% load. If the motor operates at slower than 10% speed with 100% load, it will cause motor overload.

Load Tolerance	Cooling Capability	Overload Characteristics (at 100% motor load)
	<p>This motor is designed to withstand increased temperatures during continuous operation in the low speed range (10% base frequency).</p>	<p>The motor operates continuously at 10% to 100% base frequency. Operating slower than 10% speed at 100% load will cause motor overload.</p>

3 : Constant Torque 100:1 SpeedRange

Use this setting for vector motors with a speed range for constant torque of 1:100.

The speed control for this motor is 1% to 100% when at 100% load. If the motor operates at slower than 1% speed with 100% load, it will cause motor overload.

Load Tolerance	Cooling Capability	Overload Characteristics (at 100% motor load)
	<p>This motor is designed to withstand increased temperatures during continuous operation in the low speed range (1% base frequency).</p>	<p>The motor operates continuously at 1% to 100% base frequency. Operating slower than 1% speed at 100% load will cause motor overload.</p>

4 : PM Variable Torque

Use this setting for PM motors with derated torque characteristics.

The overload tolerance decreases as motor speed decreases because the cooling fan speed decreases and the ability of the motor to cool decreases in the low speed range.

The overload tolerance characteristics of the motor change the trigger point for the electronic thermal protector. This provides motor overheat protection from low speed to high speed across the full speed range.

Load Tolerance	Cooling Capability	Overload Characteristics (at 100% motor load)
	<p>This motor is designed to withstand increased temperatures during continuous operation at rated speed and rated torque.</p>	<p>If the motor operates continuously at lower speed than rated rotation speed at more than 100% torque, the drive will detect <i>oLL</i>. The drive triggers a fault relay output and the motor coasts to stop.</p>

5 : PM Constant Torque

Use this setting with a PM motor for constant torque that has a speed range for constant torque of 1:500.

The speed control for this motor is 0.2% to 100% when at 100% load. If the motor operates at slower than 0.2% speed with 100% load, it will cause motor overload.

Load Tolerance	Cooling Capability	Overload Characteristics (at 100% motor load)
	<p>This motor is designed to withstand increased temperatures during continuous operation in the low speed range (0.2% base frequency).</p>	<p>The motor operates continuously at 0.2% to 100% rated speed. Operating slower than 0.2% speed at 100% load will cause motor overload.</p>

6 : Variable Torque (50Hz)

Use this setting for general-purpose motors with a 50 Hz base frequency.

The overload tolerance decreases as motor speed decreases because the cooling fan speed decreases and the ability of the motor to cool decreases in the low speed range.

The overload tolerance characteristics of the motor change the trigger point for the electronic thermal protector. This provides motor overheat protection from low speed to high speed across the full speed range.

Load Tolerance	Cooling Capability	Overload Characteristics (at 100% motor load)
	<p>This motor is designed to operate with commercial line power. Operate at a 50 Hz base frequency to maximize the motor cooling ability.</p>	<p>If the motor operates at frequencies less than commercial line power, the drive will detect <i>o.l.l.</i> The drive triggers a fault relay output and the motor coasts to stop.</p>

■ L1-02: Motor Overload Protection Time

No. (Hex.)	Name	Description	Default (Range)
L1-02 (0481)	Motor Overload Protection Time	V/f CL-V/f OLV CLV AOLV OLV/PM AOLV/PM CLV/PM EZOLV <p>Sets the operation time for the electronic thermal protector of the drive to prevent damage to the motor. Usually it is not necessary to change this setting.</p>	1.0 min (0.1 - 5.0 min)

Set the overload tolerance time to the length of time that the motor can operate at 150% load from continuous operation at 100% load.

When the motor operates at 150% load continuously for 1 minute after continuous operation at 100% load (hot start), the default setting triggers the electronic thermal protector.

Figure 12.122 shows an example of the electronic thermal protector operation time. Motor overload protection operates in the range between a cold start and a hot start.

This example shows a general-purpose motor operating at the base frequency with L1-02 set to 1.0 min.

• Cold start

Shows the motor protection operation time characteristics when the overload occurs immediately after starting operation from a complete stop.

• Hot start

Shows the motor protection operation time characteristics when overload occurs from continuous operation below the motor rated current.

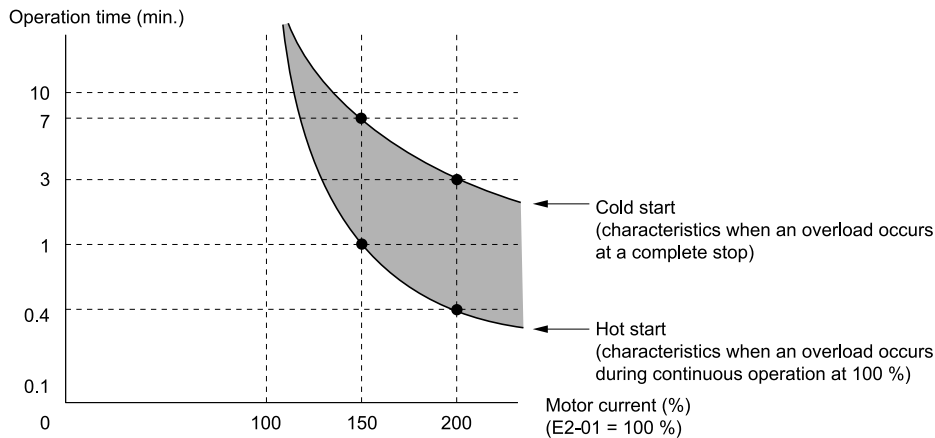

Figure 12.122 Protection Operation Time for a General-purpose Motor at Rated Output Frequency

■ L1-03: Motor Thermistor oH Alarm Select

No. (Hex.)	Name	Description	Default (Range)
L1-03 (0482)	Motor Thermistor oH Alarm Select	<div style="display: flex; justify-content: space-between; gap: 5px;"> V/f CL-V/f OLV CLV AOLV OLV/PM AOLV/PM CLV/PM EZOLV </div> Sets drive operation when the PTC input signal entered into the drive is at the <i>oH3 [Motor Overheat Alarm]</i> detection level.	3 (0 - 3)

0 : Ramp to Stop

The drive ramps the motor to stop in the deceleration time. Fault relay output terminal MA-MC turns ON and MB-MC turns OFF.

1 : Coast to Stop

The output turns OFF and the motor coasts to stop. Fault relay output terminal MA-MC turns ON, and MB-MC turns OFF.

2 : Fast Stop (Use C1-09)

The drive stops the motor in the deceleration time set in *C1-09 [Fast Stop Time]*. Fault relay output terminal MA-MC turns ON, and MB-MC turns OFF.

3 : Alarm Only

The keypad shows *oH3*, and operation continues. The output terminal set for *Alarm [H2-01 to H2-03 = 10]* turns ON.

■ L1-04: Motor Thermistor oH Fault Select

No. (Hex.)	Name	Description	Default (Range)
L1-04 (0483)	Motor Thermistor oH Fault Select	<div style="display: flex; justify-content: space-between; gap: 5px;"> V/f CL-V/f OLV CLV AOLV OLV/PM AOLV/PM CLV/PM EZOLV </div> Sets the drive operation when the PTC input signal to the drive is at the <i>oH4 [Motor Overheat Fault (PTC Input)]</i> detection level.	1 (0 - 2)

0 : Ramp to Stop

The drive ramps the motor to stop in the deceleration time. Fault relay output terminal MA-MC turns ON and MB-MC turns OFF.

1 : Coast to Stop

The output turns OFF and the motor coasts to stop. Fault relay output terminal MA-MC turns ON, and MB-MC turns OFF.

2 : Fast Stop (Use C1-09)

The drive stops the motor in the deceleration time set in *C1-09 [Fast Stop Time]*. Fault relay output terminal MA-MC turns ON, and MB-MC turns OFF.

■ L1-05: Motor Thermistor Filter Time

No. (Hex.)	Name	Description	Default (Range)
L1-05 (0484)	Motor Thermistor Filter Time	<div style="display: flex; justify-content: space-between; gap: 5px;"> V/f CL-V/f OLV CLV AOLV OLV/PM AOLV/PM CLV/PM EZOLV </div> Sets the primary delay time constant for the PTC input signal entered to the drive. This parameter prevents accidental motor overheat faults.	0.20 s (0.00 - 10.00 s)

■ L1-08: oL1 Current Level

No. (Hex.)	Name	Description	Default (Range)
L1-08 (1103)	oL1 Current Level	<div style="display: flex; justify-content: space-between; gap: 5px;"> V/f CL-V/f OLV CLV AOLV OLV/PM AOLV/PM CLV/PM EZOLV </div> Sets the reference current for the motor 1 thermal overload detection. When the current level > 0.0 A, you cannot set this value < 10% of drive rated current.	0.0 A (0.0 A or 10% to 150% of the drive rated current)

When *L1-08 = 0.0 A*, the drive uses *E2-01 [Motor Rated Current (FLA)]* to detect the motor overload protection. In PM control mode, the drive uses *E5-03 [PM Motor Rated Current (FLA)]* to detect the motor overload protection.

When *L1-08 ≠ 0.0 A*, the set value is the reference for motor overload protection.

12.9 L: Protection Functions

Note:

- Display is in these units:
 - Models 2004 to 2042, 4002 to 4023: 0.01 A
 - Models 2056 to 2415, 4031 to 4720: 0.1 A
- When the current level > 0.0 A, you cannot set this value < 10% of drive rated current.

■ L1-09: oL1 Current Level for Motor 2

No. (Hex.)	Name	Description	Default (Range)
L1-09 (1104)	oL1 Current Level for Motor 2	V/f CL-V/f OLV CLV AOLV OLV/PM AOLV/PM CLV/PM EZOLV Sets the reference current for the motor 2 thermal overload detection. When the current level > 0.0 A, you cannot set this value < 10% of drive rated current.	0.0 A (0.0 A or 10 to 150% of the drive rated current)

When $L1-09 = 0.0 A$, the drive uses $E4-01$ [Motor 2 Rated Current] to detect the motor overload protection.

When $L1-09 \neq 0.0 A$, the set value is the reference for motor overload protection.

Note:

- Display is in these units:
 - Models 2004 to 2042, 4002 to 4023: 0.01 A
 - Models 2056 to 2415, 4031 to 4720: 0.1 A
- When the current level > 0.0 A, you cannot set this value < 10% of drive rated current.

■ L1-13: Motor Overload Memory Selection

No. (Hex.)	Name	Description	Default (Range)
L1-13 (046D)	Motor Overload Memory Selection	V/f CL-V/f OLV CLV AOLV OLV/PM AOLV/PM CLV/PM EZOLV Sets the function that keeps the current electronic thermal protector value when the drive stops receiving power.	1 (0, 1)

0 : Disabled

1 : Enabled

Sets if the drive will calculate the motor again when the drive is energized again.

◆ L2: Power Loss Ride Through

$L2$ parameters set the drive operation during momentary power loss and the KEB Ride-Thru function method of operation.

■ KEB Ride-Thru Function

KEB is an acronym for Kinetic Energy Backup. If the drive detects a power loss or momentary power loss, it will quickly decelerate the motor. The drive uses regenerative energy from the motor to keep the main circuit operating. When you return power during motor deceleration, the drive returns operation to the status before the power loss. The KEB Ride-Thru function is different than other functions for continuous operation. If the drive detects momentary power loss, the motor will ramp to stop. It will not coast to stop. This function is applicable for applications in which it is necessary to prevent materials from running out, for example control for film and fiber lines.

The KEB Ride-Thru function has 4 methods of operation. Parameter $L2-29$ [Kinetic Energy Backup Method] sets the method.

When you use the KEB Ride-Thru function with one drive, set $L2-29 = 0, 1$ [Single Drive KEB Ride-Thru 1, Single Drive KEB Ride-Thru 2].

If deceleration in coordination with more than one drive is necessary, for example textile machinery line systems, set $L2-29 = 2, 3$ [System KEB Ride-Thru 1, System KEB Ride-Thru 2].

Table 12.66 KEB Ride-Thru Function Operation Method

L2-29	Kinetic Energy Backup Method	Operation	Configuration Precautions
0	Single Drive KEB Ride-Thru 1	The drive uses regenerative energy from the motor to keep the DC bus voltage at the level set in L2-11 [KEB DC Bus Voltage Setpoint] while it adjusts the rate of deceleration. The KEB operation continues while the drive adjusts the deceleration rate with the setting of C1-09 [Fast Stop Time].	<ul style="list-style-type: none"> Set C1-09 correctly to prevent $Uv1$ [DC Bus Undervoltage] and ov [Overvoltage]. If the drive detects $Uv1$ during the KEB operation, decrease the value set in C1-09. If the drive detects ov during the KEB operation, increase the value set in C1-09.
1	Single Drive KEB Ride-Thru 2	The drive uses information about the inertia of the connected machinery to find the deceleration rate necessary to keep the DC bus voltage at the level set in parameter L2-11. The drive uses system inertia to calculate the deceleration time. You cannot adjust this value.	<ul style="list-style-type: none"> If the drive detects $Uv1$ during the KEB operation, increase the setting value of L3-20 [DC Bus Voltage Adjustment Gain] and L3-21 [OV Suppression Accel/Decel P Gain]. If the drive detects ov during the KEB operation, decrease the setting values of L3-20 and L3-21.
2	System KEB Ride-Thru 1	The drive does not monitor the DC bus voltage. The drive decelerates at the KEB deceleration time set in L2-06. Use L2-06 to set the time necessary to decelerate from the current frequency reference to 0 Hz. More than one drive can decelerate and keep a constant speed ratio between drives.	Use the dynamic braking option with System KEB Ride-Thru 1.
3	System KEB Ride-Thru 2	The drive uses the KEB deceleration time set in L2-06 to decelerate and it also monitors the DC bus voltage. If the voltage level increases, the drive momentarily holds the frequency to prevent an ov before it continues to decelerate.	If you cannot use the dynamic braking option, use System KEB Ride-Thru 2.

■ KEB Ride Thru Start

When L2-01 = 3, 4, 5 [Power Loss Ride Through Select = Kinetic Energy Backup: L2-02, Kinetic Energy Backup: CPU Power, Kinetic Energy Backup: DecelStop], the drive starts the KEB operation immediately after it detects a momentary power loss. When one of these conditions occur, the drive will activate KEB Ride-Thru:

- KEB Ride-Thru 1 set for the MFDI terminal becomes enabled (terminal is deactivated when $H1-xx = 65$ or terminal is activated when $H1-xx = 66$).
The drive uses the mode selected L2-29 [Kinetic Energy Backup Method] to start KEB operation.
- KEB Ride-Thru 2 set for the MFDI terminal becomes enabled (terminal is deactivated when $H1-xx = 7A$ or terminal is activated when $H1-xx = 7B$).
The drive automatically starts Single KEB Ride-Thru 2 and it ignores the setting of L2-29.
- The DC bus voltage is less than the level set in L2-05 [Undervoltage Detection Lvl ($Uv1$)].
The KEB operation will start as specified in L2-29.

Note:

If you try to set KEB Ride-Thru 1 and 2 to the MFDI terminals at the same time, it will trigger $oPE03$ [Multi-Function Input Setting Err].

In this example, the drive detects that the DC bus voltage is less than the level set in L2-05 and starts the KEB operation. When you return power during KEB operation, the drive will continue KEB operation when the KEB Ride-Thru is input, although the time set in L2-10 [Minimum KEB Time] expired. The motor accelerates again after you cancel the KEB Ride-Thru.

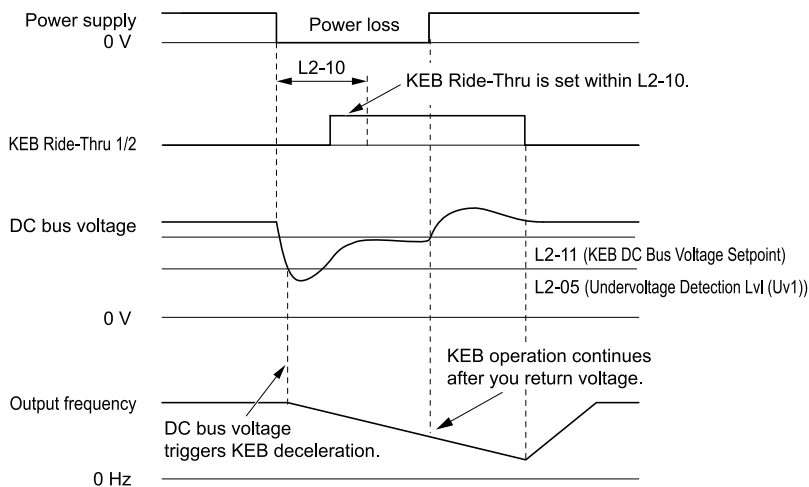

Figure 12.123 KEB Operation through KEB Ride-Thru Input

■ KEB Ride-Through End Detection

Parameter *L2-01* [*Power Loss Ride Through Select*] and a digital input programmed for KEB set the KEB function end detection.

Use the Momentary Power Loss Ride-Through Time to Cancel KEB Operation

shows an example with this configuration:

- *L2-01* = 3 [*Kinetic Energy Backup: L2-02*] is set.
- KEB Ride-Through is not used.

The drive starts deceleration through KEB operation. When the time set in *L2-10* [*Minimum KEB Time*] expires, the drive stops the KEB operation and then it accelerates the motor again until it is at the frequency reference value used before the power loss.

If you do not return the DC bus voltage in the time set in *L2-02* [*Power Loss Ride Through Time*], the drive detects *Uv1* [*DC Bus Undervoltage*] and the drive turns off its output.

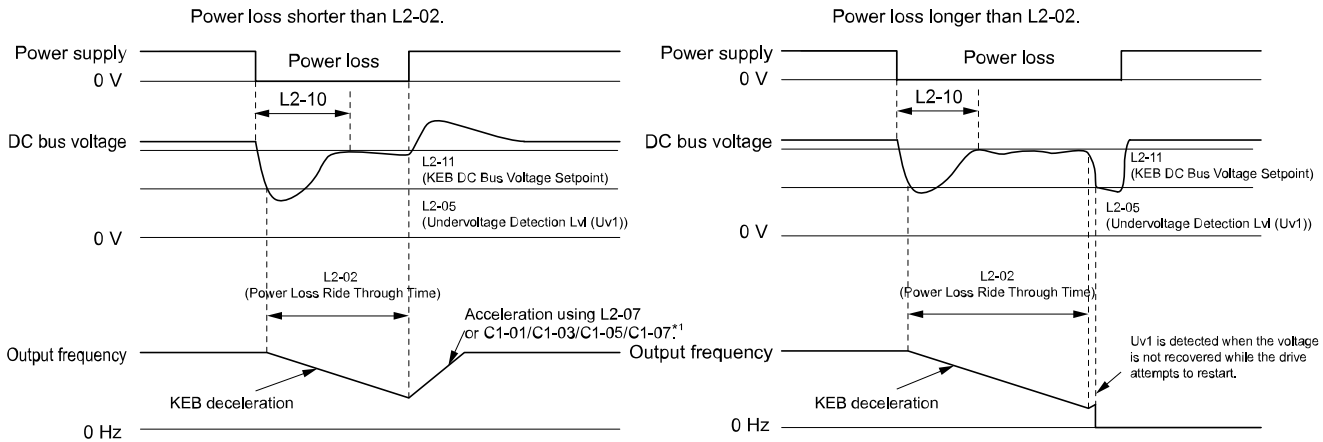

Figure 12.124 Cancel the KEB Operation after the Momentary Power Loss Ride-Through Time Is Expired without KEB Ride-Through

*1 When *L2-07* = 0.00 [*Kinetic Energy Backup Accel Time* = 0.00 s], the drive accelerates again as specified by the applicable *Acceleration Time* [*C1-01, C1-03, C1-05, C1-07*], and usual operation continues.

Use the Momentary Power Loss Ride-Through Time and KEB Ride-Through to Cancel KEB Operation

shows an example with this configuration:

- *L2-01* = 3.
- Use *KEB Ride-Through 1* [*H1-xx* = 65, 66] or *KEB Ride-Through 2* [*H1-xx* = 7A, 7B].

The drive starts deceleration through KEB operation. The drive decelerates for the time set in parameter *L2-10*, then it measures the DC bus voltage and the status of the digital input terminal set for KEB Ride-Through. When the DC bus voltage is less than the level set in *L2-11* [*KEB DC Bus Voltage Setpoint*], or if the KEB digital input is active, KEB deceleration continues. When the DC bus voltage is more than the level set in *L2-11*, the drive ends KEB operation. The drive accelerates the motor to the frequency reference value before the power loss, and usual operation continues. If the time set in *L2-02* is expired, the drive detects *Uv1*. When you cancel the KEB Ride-Through, the motor accelerates again, and usual operation continues.

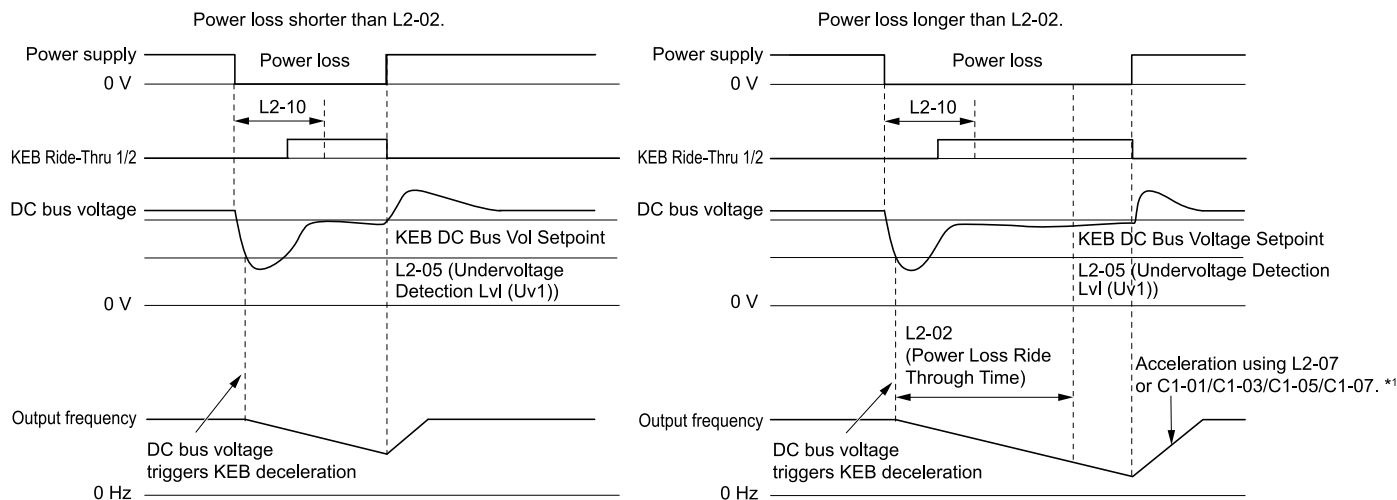

Figure 12.125 Use the Momentary Power Loss Ride-Thru Time and KEB Ride-Thru to Cancel KEB Operation

*1 When $L2-07 = 0.00$, the drive accelerates again as specified by the applicable *Acceleration Time* [$C1-01$, $C1-03$, $C1-05$, $C1-07$], and usual operation continues.

Cancel KEB Operation When Restoration of Power Occurs while the Control Power (Power Supply to the Control Board) is Maintained

shows an example with this configuration:

- $L2-01 = 4$ [*Kinetic Energy Backup: CPU Power*] is set.
- KEB Ride-Thru is not used.

The drive starts deceleration through KEB operation. The drive decelerates for the time set in parameter $L2-10$, and then measures the DC bus voltage level. When the DC bus voltage is lower than the level set in $L2-11$, the drive uses the KEB Ride-Thru function to continue deceleration. When the DC bus voltage is more than the level set in $L2-11$, usual operation continues. The drive accelerates the motor to the frequency reference value before the power loss, and usual operation continues.

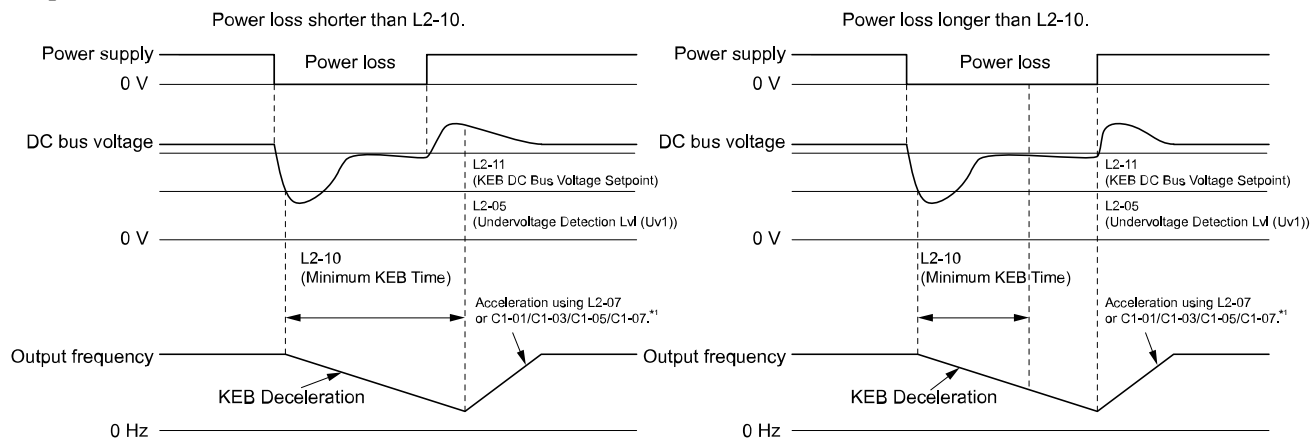

Figure 12.126 Cancel KEB Operation without Using the KEB Ride-Thru if Restoration of Power Occurs while the Control Power (Power Supply to the Control Board) is Maintained

*1 When $L2-07 = 0.00$ s, the drive accelerates again as specified by the applicable *Acceleration Time* [$C1-01$, $C1-03$, $C1-05$, $C1-07$], and usual operation continues.

Use the KEB Ride-Thru to Cancel KEB Operation when Restoration of Power Occurs while the Control Power (Power Supply to the Control Board) is Maintained

shows an example with this configuration:

- $L2-01 = 4$.
- Use *KEB Ride-Thru 1* [$H1-xx = 65, 66$] or *KEB Ride-Thru 2* [$H1-xx = 7A, 7B$].

The drive starts deceleration through KEB operation. When the motor decelerates for the time set in *L2-10*, the drive measures the DC bus voltage and the status of the digital input set for KEB Ride-Thru. When the DC bus voltage is less than the level set in *L2-11*, or if the digital input set to KEB Ride-Thru is active, deceleration continues. When the DC bus voltage is more than the level set in *L2-11*, the drive ends KEB operation. The drive accelerates the motor to the frequency reference value before the power loss, and usual operation continues. When the KEB Ride-Thru continues to be input after the time set in *L2-02* is expired, the drive uses the KEB Ride-Thru function to continue to decelerate. When you cancel the KEB Ride-Thru, the motor accelerates again, and usual operation continues.

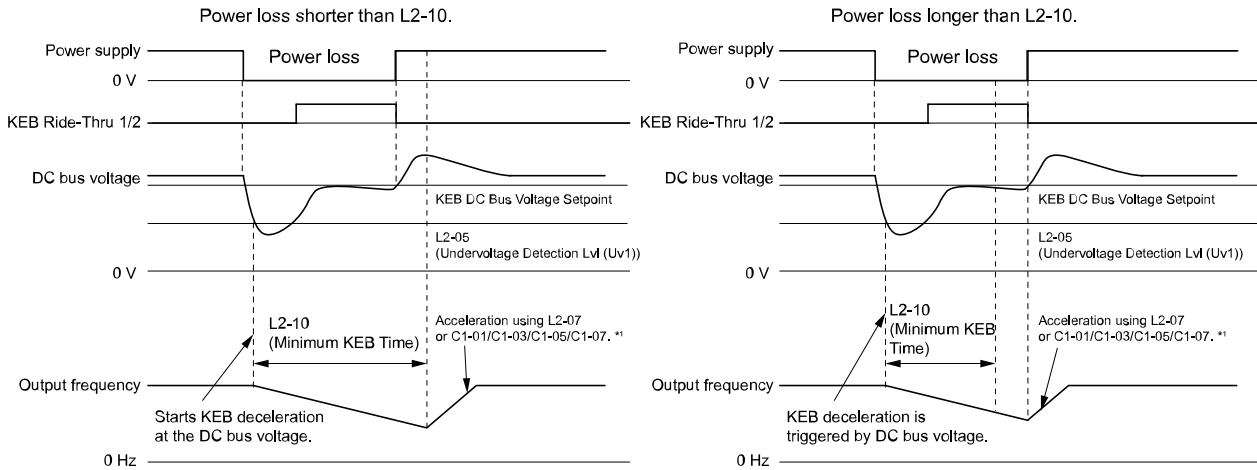

Figure 12.127 Use the KEB Ride-Thru to Cancel KEB Operation when Restoration of Power Occurs while the Control Power (Power Supply to the Control Board) is Maintained

*1 When *L2-07 = 0.00 s*, the drive accelerates again as specified by the applicable *Acceleration Time [C1-01, C1-03, C1-05, C1-07]*, and usual operation continues.

KEB Operation when L2-01 = 5 [Kinetic Energy Backup: DecelStop]

The drive starts deceleration through KEB operation. If you do not input the Run command, the motor cannot restart. The drive will continue to decelerate until the motor comes to the minimum output frequency or a complete stop. If you return power during deceleration, the drive continues to decelerate.

■ KEB Operation Wiring Example

Figure 12.128 shows an example that uses an undervoltage relay to trigger the KEB Ride-Thru at power loss. When a power loss occurs, the undervoltage relay triggers *KEB Ride-Thru [H1-06 = 65, 66, 7A, 7B]* at terminal S6.

Note:

- Configure the drive to turn ON the Run command while the KEB function is operating. If you turn off the Run command, the drive will not accelerate back to speed when you return power.
- A dynamic braking option is necessary for *System KEB Ride-Thru 1 [L2-29 = 2]*.

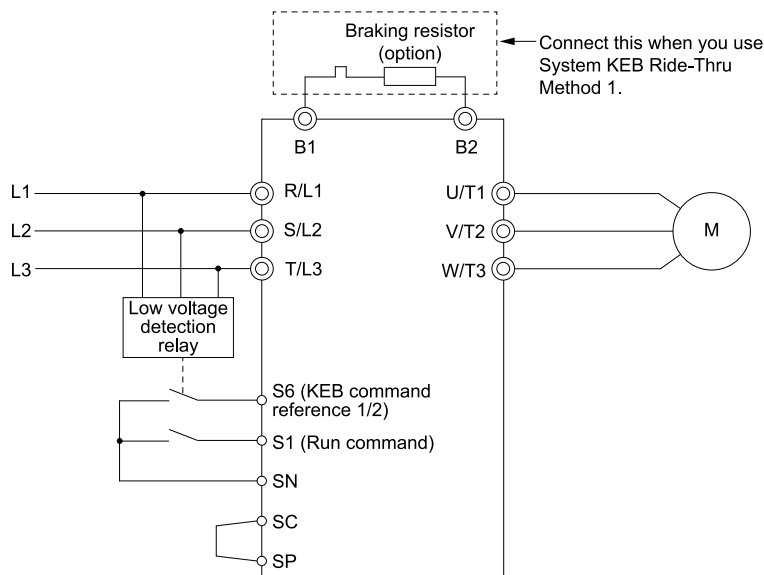

Figure 12.128 KEB Function Wiring Example

Parameters for KEB Ride-Thru

Table 12.67 shows the parameters that adjust the KEB Ride-Thru function. Parameter settings are different for the different KEB methods set in L2-29 [Kinetic Energy Backup Method].

Table 12.67 Parameters for KEB Ride-Thru

No.	Name	Configuring Settings	L2-29 [Kinetic Energy Backup Method]			
			0	1	2	3
C1-09	Fast Stop Time	<ul style="list-style-type: none"> If <i>ov</i> [Overvoltage] occurs during KEB deceleration, increase the setting value. If <i>Uv1</i> [DC Bus Undervoltage] occurs during KEB deceleration, decrease the setting value. 	x *1	-	-	-
C2-03	S-Curve Time @ Start of Decel	<ul style="list-style-type: none"> If <i>ov</i> occurs immediately after you start KEB deceleration, increase the setting value. If <i>Uv1</i> occurs immediately after you start KEB deceleration, decrease the setting value. 	x	-	x	x
L2-05	Undervoltage Detection Lvl (Uv1)	If <i>Uv1</i> occurs immediately after you start KEB deceleration, increase the setting value to detect power loss more quickly.	x	x	x	x
L2-06	Does KEB Tuning.	<ul style="list-style-type: none"> Kinetic Energy Backup Decel Time If <i>ov</i> or <i>Uv1</i> occur during KEB deceleration after KEB Tuning, set L2-06 in these conditions: <ul style="list-style-type: none"> - If <i>ov</i> occurs, increase the setting value - If <i>Uv1</i> occurs, decrease the setting value. 	-	-	x *2	x *2
L2-07	Kinetic Energy Backup Accel Time	Sets the acceleration time to return to the frequency reference value before a power loss, after you cancel the KEB operation. When L2-07 = 0, the drive uses the standard acceleration times set in C1-01, C1-03, C1-05, and C1-07 [Acceleration Time].	x	x	x	x
L2-08	Frequency Gain at KEB Start	<ul style="list-style-type: none"> If <i>ov</i> occurs immediately after you start operation, decrease the setting value. If <i>Uv1</i> occurs immediately after you start operation, increase the setting value. 	x	-	x	x
L2-10	Minimum KEB Time	<ul style="list-style-type: none"> With KEB Ride-Thru There is <i>Uv1</i> because you set a digital input for KEB Ride-Thru and the device that controls the input operated too slowly after power loss. Without KEB Ride-Thru If the DC bus voltage overshoots immediately after KEB Ride-Thru starts, increase L2-10 to longer than the overshoot. 	x	x	x	x
L2-11	KEB DC Bus Voltage Setpoint	<ul style="list-style-type: none"> Single Drive KEB Ride-Thru 2 Set to approximately 1.22 x input voltage. Single Drive KEB Ride-Thru 1, System KEB Ride-Thru 1, or System KEB Ride-Thru 2 Set to approximately 1.4 x input voltage. 	x	x	x	x
L3-20	DC Bus Voltage Adjustment Gain	<ul style="list-style-type: none"> If <i>ov</i> or <i>Uv1</i> occurs at the start of deceleration when you use KEB operation, increase this value in 0.1-unit increments. If there is torque ripple during deceleration when you use KEB Ride-Thru, decrease the value. 	-	x	-	-

Parameter Details

No.	Name	Configuring Settings	L2-29 [Kinetic Energy Backup Method]			
			0	1	2	3
L3-21	OV Suppression Accel/Decel P Gain	If there is large speed or current ripple, decrease the value in 0.05 unit increments. Note: If the setting value is too low, then the drive will have unsatisfactory DC bus voltage control response. The drive can detect <i>ov</i> or <i>Uv1</i> .	-	x	-	-
L3-24	Motor Accel Time @ Rated Torque	Set the motor acceleration time to the maximum frequency at the motor rated torque.	-	x	-	-
L3-25	Load Inertia Ratio	Sets the ratio between motor inertia and machine inertia.	-	x *3	-	-

- *1 When L2-29 = 0 [Kinetic Energy Backup Method = Single Drive KEB Ride-Thru 1] and you do KEB Auto-Tuning, the drive will automatically set C1-09. If you must not change the Fast Stop time, do not do KEB Tuning.
- *2 If you do KEB Tuning when L2-29 = 1, 2, or 3 [Kinetic Energy Backup Method = Single Drive KEB Ride-Thru 2, System KEB Ride-Thru 1, or System KEB Ride-Thru 2], the drive will automatically set L2-06 [Kinetic Energy Backup Decel Time].
- *3 The drive sets this value automatically when KEB Tuning completes correctly.

■ L2-01: Power Loss Ride Through Select

No. (Hex.)	Name	Description	Default (Range)
L2-01 (0485)	Power Loss Ride Through Select	V/f CL-V/f OLV CLV AOLV OLV/PM AOLV/PM CLV/PM EZOLV Sets the drive operation after a momentary power loss.	0 (0 - 5)

The drive detects momentary power loss when the drive DC bus voltage is less than the value set in L2-05 [Undervoltage Detection Lvl (*Uv1*)].

0 : Disabled

The drive detects *Uv1* [DC Bus Undervoltage] is detected when there is a momentary power loss. If you do not return power in 15 ms, it triggers *Uv1* and the drive shuts off the output. The motor coasts to stop.

1 : Enabled for L2-02 Time

When power returns in the time set in L2-02 [Power Loss Ride Through Time], the drive will restart. If power does not return in the time set in L2-02, the drive will detect *Uv1*.

The drive momentarily turns OFF its output after a power loss. If the power returns in the time set to L2-02, the drive will do Speed Search and try to continue operation.

If the DC bus voltage is less than or equal to the *Uv1* detection level for the time set in L2-02, the drive will detect *Uv1* and output a fault signal.

Note:

- The necessary time for the drive to restart after power returns is different for different drive capacities.
- The upper limit of the possible momentary power loss Ride-Thru time is different for different drive models.

2 : Enabled while CPU Power Active

When power returns and the drive control circuit has power, the drive will restart. This will not trigger *Uv1*.

When there is a momentary power loss, the drive output will turn OFF. If the power returns and the drive control circuit has power, the drive will do Speed Search and try to continue operation. This will not trigger a *Uv1*. This function enables longer support for power loss than when L2-01 = 1.

3 : Kinetic Energy Backup: L2-02

If power does not return in the time set in L2-02, the drive will detect *Uv1*.

If the drive detects momentary power loss, the drive will use regenerative energy from the motor and ramp to stop. When you return power in the time set in L2-02, the drive will accelerate to the frequency reference value that was used before the power loss. If you do not return power in the time set to L2-02, the drive will detect *Uv1* and the drive output will turn OFF. L2-29 [Kinetic Energy Backup Method] sets the type of KEB operation.

4 : Kinetic Energy Backup: CPU Power

When power returns and the drive control circuit has power, the drive will restart.

The drive decelerates using regenerative energy from the motor until the power returns and then restarts when a momentary power loss is detected. When power is restored during deceleration, the drive accelerates the motor again to the frequency reference value used before the power loss. If the motor comes to a stop before the power returns, the

drive loses control power and the drive output shuts off. A *UvI* is not triggered when power is restored while power to the CPU in the drive is maintained. *L2-29* sets the type of KEB operation.

5 : Kinetic Energy Backup: DecelStop

When power returns, the drive will continue to decelerate until the motor fully stops.

If the drive detects momentary power loss, the drive will use regenerative energy from the motor and ramp to stop. When you return power to the drive, the drive will continue to decelerate until the motor comes to a full stop. After you return power, the drive will ramp to stop in the set deceleration time. *L2-29* sets the type of KEB operation.

Note:

When you set *L2-01*, make sure that you know these items:

- You can use a Momentary Power Loss Unit on models 2004 to 2056 and 4002 to 4031 for a longer momentary power loss ride through time. A Momentary Power Loss Unit makes it possible to continue operation of the drive after a maximum of 2 seconds of power loss.
- When you set *L2-01 = 1 to 4*, keep the magnetic contactor on the drive input side closed and keep the control signal while the drive does KEB operation.
- When *L2-01 = 1 to 5*, *Uv [DC Bus Undervoltage]* will flash on the keypad while the drive is attempting to recover from a momentary power loss. The drive will not output a fault signal at this time.
- When you use a magnetic contactor between the motor and the drive, keep the magnetic contactor closed while the drive does KEB operation or tries to restart with Speed Search.
- Keep the Run command active during KEB operation. The drive cannot accelerate back to the frequency reference when the power returns.
- When you set *L2-01 = 3 to 5*, if the control power supply voltage is less than the CPU operation level during KEB Ride-Thru, it will trigger *UvI*.

■ L2-02: Power Loss Ride Through Time

No. (Hex.)	Name	Description	Default (Range)
L2-02 (0486)	Power Loss Ride Through Time	V/f CL-V/f OLV CLV AOLV OLV/PM AOLV/PM CLV/PM EZOLV Sets the maximum time that the drive will wait until trying to restart after power loss.	Determined by o2-04, C6-01 (0.0 - 25.5 s)

This function is applicable when *L2-01 = 1, 3 [Power Loss Ride Through Select = Enabled for L2-02 Time, Kinetic Energy Backup: L2-02]*. If power loss operation is longer than the time set in this parameter, the drive will detect *UvI [DC Bus Undervoltage]*, turn OFF output, and the motor will coast to stop.

Note:

- The length of time that the drive can recover after a power loss changes when drive capacity changes.
- The upper limit of the possible momentary power loss Ride-Thru time changes when drive capacity changes.

■ L2-03: Minimum Baseblock Time

No. (Hex.)	Name	Description	Default (Range)
L2-03 (0487)	Minimum Baseblock Time	V/f CL-V/f OLV CLV AOLV OLV/PM AOLV/PM CLV/PM EZOLV Sets the minimum time to continue the drive output block (baseblock) after a baseblock.	Determined by o2-04, C6-01 (0.1 - 5.0 s)

Sets the length of time that the drive will wait for the residual voltage in the motor to dissipate in estimation to the secondary circuit time constant of the motor. If *oC [Overcurrent]* or *ov [DC Bus Overvoltage]* occur at the start of Speed Search, after power returns, or during DC Injection Braking, increase this setting.

■ L2-04: Powerloss V/f Recovery Ramp Time

No. (Hex.)	Name	Description	Default (Range)
L2-04 (0488)	Powerloss V/f Recovery Ramp Time	V/f CL-V/f OLV CLV AOLV OLV/PM AOLV/PM CLV/PM EZOLV Sets the time for the drive output voltage to go back to correct voltage after completing speed searches.	Determined by o2-04, C6-01 (0.0 - 5.0 s)

Sets the time for voltage to recover from 0 V to the value set in *E1-05 [Maximum Output Voltage]*.

■ **L2-05: Undervoltage Detection Lvl (Uv1)**

No. (Hex.)	Name	Description	Default (Range)
L2-05 (0489)	Undervoltage Detection Lvl (Uv1)	<div style="display: flex; justify-content: space-between; font-size: small;"> V/f CL-V/f OLV CLV AOLV OLV/PM AOLV/PM CLV/PM EZOLV </div> <p>Sets the voltage at which a <i>Uv1</i> [DC Bus Undervoltage] fault is triggered or at which the KEB function is activated. Usually it is not necessary to change this setting.</p>	Determined by o2-04 and E1-01 (200 V Class: 150 - 210 V, 400 V Class: 300 - 420 V)

NOTICE: Damage to Equipment. When you set this parameter to a value lower than the default, you must install an AC reactor on the input side of the power supply. If you do not install an AC reactor, it will cause damage to the drive circuitry.

Note:

If the low voltage detection level is near the lower limit value of L2-05, the drive will detect *Uv1* during KEB Ride-Thru operation. Do not set the value too low when you use the KEB Ride-Thru function.

■ **L2-06: Kinetic Energy Backup Decel Time**

No. (Hex.)	Name	Description	Default (Range)
L2-06 (048A) Expert	Kinetic Energy Backup Decel Time	<div style="display: flex; justify-content: space-between; font-size: small;"> V/f CL-V/f OLV CLV AOLV OLV/PM AOLV/PM CLV/PM EZOLV </div> <p>Sets the deceleration time during KEB operation used to decrease the maximum output frequency to 0.</p>	0.0 s (0.0 - 6000.0 s)

Set L2-29 = 2 or 3 [Kinetic Energy Backup Method = System KEB Ride-Thru 1 or System KEB Ride-Thru 2] to enable this function. When L2-29 = 1, 2, 3 [Kinetic Energy Backup Method = Single Drive KEB Ride-Thru 2, System KEB Ride-Thru 1, System KEB Ride-Thru 2] and you do KEB Auto-Tuning, the drive will automatically set this value.

Sets the deceleration time necessary to decelerate from the frequency reference to 0 Hz when the drive detects a momentary power loss. If a *Uv1* [DC Bus Undervoltage] fault occurs during KEB operation, decrease the deceleration time. If an *ov* [Overvoltage] fault occurs, increase the deceleration time.

• L2-06 = 0

The drive automatically decreases C1-09 [Fast Stop Time] to the base value to keep the DC bus voltage above the low voltage detection level. The drive ignores L2-02 [Momentary Power Loss Ride-Thru Time] in this condition.

• L2-06 ≠ 0

As shown in Figure 12.129, the frequency reference decelerates to the KEB frequency level as specified by the deceleration rate set in L2-06 and then returns to the initial frequency reference as specified by C1-01 [Acceleration Time 1]. The drive uses the setting value of the KEB frequency rate as shown in the this formula to set the KEB frequency level:

$$\text{KEB frequency level} = \text{Output frequency before power loss} \times (1 - (L2-02) / (L2-06))$$

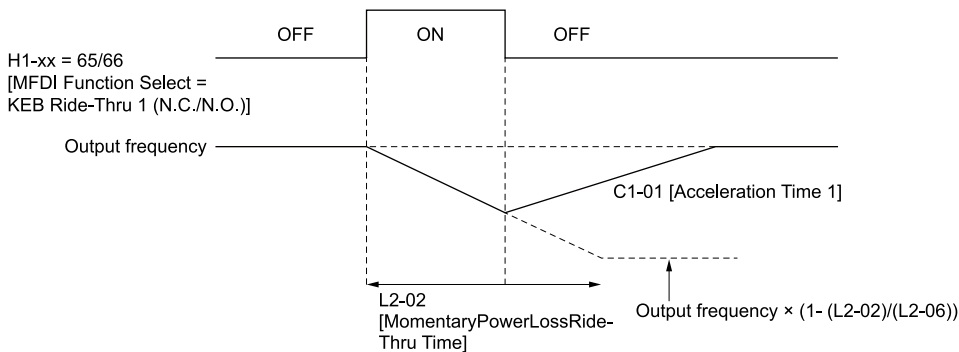

Figure 12.129 Kinetic Energy Backup Decel Time

■ **L2-07: Kinetic Energy Backup Accel Time**

No. (Hex.)	Name	Description	Default (Range)
L2-07 (048B) Expert	Kinetic Energy Backup Accel Time	<div style="display: flex; justify-content: space-between; font-size: small;"> V/f CL-V/f OLV CLV AOLV OLV/PM AOLV/PM CLV/PM EZOLV </div> <p>Sets the acceleration time to return the frequency to the frequency reference before a power loss after canceling KEB operation.</p>	0.0 s (0.0 - 6000.0 s)

Set this parameter to 0.0 to disable the function. The drive uses the acceleration time in *C1-01*, *C1-03*, *C1-05*, and *C1-07* to accelerate again after KEB operation completes.

■ L2-08: Frequency Gain at KEB Start

No. (Hex.)	Name	Description	Default (Range)
L2-08 (048C) Expert	Frequency Gain at KEB Start	V/f CL-V/f OLV CLV AOLV OLV/PM AOLV/PM CLV/PM EZOLV Sets the quantity of output frequency reduction used when KEB operation starts as a percentage of the motor rated slip before starting KEB operation.	100% (0 - 300%)

Decreases the output frequency in steps to quickly set the motor to a regenerative condition. Use this formula to calculate the value:

$$\text{Output frequency reduction} = \text{Motor rated slip before KEB operation} \times (L2-08/100) \times 2$$

■ L2-09: KEB Minimum Frequency Level

No. (Hex.)	Name	Description	Default (Range)
L2-09 (048D) Expert	KEB Minimum Frequency Level	V/f CL-V/f OLV CLV AOLV OLV/PM AOLV/PM CLV/PM EZOLV Sets the quantity of output frequency reduction used as a percentage of <i>E2-02</i> [Motor Rated Slip] when KEB operation starts.	20% (0 - 100%)

These conditions set the quantity of decrease:

- Motor rated slip $\times (L2-09/100)$
- The larger value between the value calculated with *L2-08* and the value calculated with *L2-09*

■ L2-10: Minimum KEB Time

No. (Hex.)	Name	Description	Default (Range)
L2-10 (048E) Expert	Minimum KEB Time	V/f CL-V/f OLV CLV AOLV OLV/PM AOLV/PM CLV/PM EZOLV Sets the minimum length of time to operate the KEB after the drive detects a momentary power loss.	50 ms (0 - 25500 ms)

When you return power while KEB is operating, the drive continues KEB operation until the time set in *L2-10* is expired. When the DC bus voltage is less than the level of *L2-05* [Undervoltage Detect Level (*Uv1*)] in one of these conditions, KEB operation continues until the time set in *L2-10* is expired:

- *L2-01* = 3 [Momentary Power Loss Ope Select = KEB Mode].
- *L2-01* = 4 [KEB Stop Mode]
- *L2-01* = 5 [KEB Decel to Stp].
- KEB Ride-Thru 1/2 [H1-xx = 65, 66, 7A, or 7B] is input into the drive.

When you input KEB Ride-Thru, KEB operation continues after the time set in *L2-10* is expired. When you cancel KEB Ride-Thru, the motor accelerates again. When you do not input KEB Ride-Thru during the time set in *L2-10*, the drive accelerates to the frequency reference that the drive had before power loss in the applicable acceleration time.

When *L2-01* = 3, 4, or 5, and the DC bus voltage is a minimum of the value of *L2-11* [DC Bus Vol Setpoint during KEB], the drive accelerates again after the time set in *L2-10* is expired. If the DC bus voltage is less than the *L2-11* value, KEB operation continues after the time set in *L2-10* is expired.

Note:

- When *L2-01* = 0, 1, or 2 [Disabled, Enabled, or Enabled when CPU is Running], increase the value of *L2-10*. Set *L2-10* to cancel KEB operation if the KEB Ride-Thru is not input
- Set this parameter to 0 to disable the function.

■ **L2-11: KEB DC Bus Voltage Setpoint**

No. (Hex.)	Name	Description	Default (Range)
L2-11 (0461) Expert	KEB DC Bus Voltage Setpoint	<div style="display: flex; justify-content: space-between; font-size: 0.8em;"> V/f CL-V/f OLV CLV AOLV OLV/PM AOLV/PM CLV/PM EZOLV </div> <p>Sets the target value that controls the DC bus voltage to a constant level in Single Drive KEB Ride-Thru 2. Sets the DC bus voltage level that completes the KEB operation for all other KEB methods.</p>	Determined by E1-01 (Determined by E1-01)

■ **L2-29: Kinetic Energy Backup Method**

No. (Hex.)	Name	Description	Default (Range)
L2-29 (0475) Expert	Kinetic Energy Backup Method	<div style="display: flex; justify-content: space-between; font-size: 0.8em;"> V/f CL-V/f OLV CLV AOLV OLV/PM AOLV/PM CLV/PM EZOLV </div> <p>Sets the KEB function operation mode.</p>	0 (0 - 3)

Set *L2-01* = 3, 4, or 5 [*Momentary Power Loss Ope Select* = *KEB Mode*, *KEB Stop Mode*, or *KEB Decel to Stp*] or *KEB Ride-Thru 1/2* [*H1-xx* = 65, 66, 7A, or 7B], to enable the KEB function.

0 : Single Drive KEB Ride-Thru 1

The drive monitors the DC bus voltage and uses regenerative energy from the motor to hold the DC bus voltage at the level set in *L2-11* [*KEB DC Bus Voltage Setpoint*].

The KEB operation continues and the deceleration rate changes as specified by *C1-09* [*Fast Stop Time*].

Note:

- If the drive detects *Uv1* [*DC Bus Undervoltage*] during KEB operation, decrease the value of *C1-09*.
- If the drive detects *ov* [*Overvoltage*] during KEB operation, increase the value of *C1-09*.

1 : Single Drive KEB Ride-Thru 2

The drive does KEB operation and automatically calculates the deceleration rate to make sure that the main circuit electrical energy and main current voltage from motor regenerative energy is equal to *L2-11* [*DC Bus Vol Setpoint during KEB*].

2 : System KEB Ride-Thru 1

The drive does not monitor the DC bus voltage and decelerates as specified by the KEB deceleration time set in *L2-06*.

Set *L2-06* to the time necessary to decelerate from the frequency reference to 0 Hz when the drive detects a momentary power loss. The drive can decelerate and keep constant deceleration rates for more than one drive.

Note:

If you keep constant deceleration rates for more than one drive, it can trigger *ov* faults. Use the dynamic braking option with System KEB Ride-Thru 1 to prevent *ov* faults.

3 : System KEB Ride-Thru 2

The drive monitors the DC bus voltage and decelerates for the deceleration time set in *L2-06*.

If the DC bus voltage increases, the drive momentarily holds the frequency to prevent *ov* while deceleration continues.

Note:

When you cannot use a dynamic braking option, use System KEB Ride-Thru.

■ **L2-30: KEB Zero Speed Operation**

No. (Hex.)	Name	Description	Default (Range)
L2-30 (045E) Expert	KEB Zero Speed Operation	<div style="display: flex; justify-content: space-between; font-size: 0.8em;"> V/f CL-V/f OLV CLV AOLV OLV/PM AOLV/PM CLV/PM EZOLV </div> <p>Sets the operation when the output frequency decreases below the zero level (DC braking injection starting frequency) during KEB deceleration when <i>L2-01</i> = 3 to 5 [<i>Power Loss Ride Through Select</i> = <i>Kinetic Energy Backup</i>: <i>L2-02</i>, <i>Kinetic Energy Backup</i>: <i>CPU Power</i>, or <i>Kinetic Energy Backup</i>: <i>DecelStop</i>].</p>	0 (0, 1)

0 : Baseblock

1 : DC/SC Braking

Does DC injection braking and short circuit braking as specified by *b2-04 [DC Inject Braking Time at Stop]* and *b2-13 [Short Circuit Brake Time @ Stop]*.

■ L2-31: KEB Start Voltage Offset Level

No. (Hex.)	Name	Description	Default (Range)
L2-31 (045D) Expert	KEB Start Voltage Offset Level	<input type="checkbox"/> V/f <input type="checkbox"/> CL-V/f <input type="checkbox"/> OLV <input type="checkbox"/> CLV <input type="checkbox"/> AOLV <input type="checkbox"/> OLVP/M <input type="checkbox"/> AOLVP/M <input type="checkbox"/> CLVP/M <input type="checkbox"/> EZOLV Sets the KEB start voltage offset.	Determined by A1-02 (200 V Class: 0 - 100 V, 400 V Class: 0 - 200 V)

The drive uses this formula to calculate the KEB start voltage:

$$\text{KEB start voltage} = L2-05 [\text{Undervoltage Detect Level (Uv1)}] + L2-31$$

◆ L3: Stall Prevention

L3 parameters set the Stall Prevention function and overvoltage suppression function.

■ Stall Prevention

If the load is too heavy or the acceleration and deceleration times are too short, the motor can slip too much because it cannot work at the same rate as the frequency reference. If the motor stalls during acceleration, current increases as the slip increases to cause an *oC [Overcurrent]*, *oL2 [Drive Overload]*, or *oL1 [Motor Overload]* and the drive will stop. If the motor stalls during deceleration, too much regenerative power will flow back into the DC bus capacitors, and cause the drive to fault out from *ov [Overvoltage]* and the drive will stop.

The stall prevention function will let the motor get to the set speed without stalling and it is not necessary for you to change the acceleration or deceleration time settings. You can set a separate stall prevention functions for acceleration, operating at constant speeds, and deceleration.

■ Overvoltage Suppression Function

Decreases the regenerative torque limit and increases the output frequency when the DC bus voltage increases to prevent *ov*. This function can drive loads with cyclic regenerative operation, for example punch presses or other applications with repeated crank movements. When you use this function, set *L3-11 = 1 [Overvoltage Suppression Select = Enabled]*.

The drive adjusts the regenerative torque limit and the output frequency during overvoltage suppression to make sure that the DC bus voltage is not more than the level set in *L3-17 [DC Bus Regulation Level]*.

Set these parameters as necessary when you use the overvoltage suppression function:

- *L3-20 [DC Bus Voltage Adjustment Gain]*
- *L3-21 [OVSuppression Accel/Decel P Gain]*
- *L3-24 [Motor Accel Time @ Rated Torque]*
- *L3-25 [Load Inertia Ratio]*

Note:

- When overvoltage suppression is triggered, the motor speed is more than the frequency reference. Do not use overvoltage suppression for applications where the frequency reference and the motor speed must align.
- When you use a braking resistor, set *L3-11 = 0 [Disabled]*.
- The overvoltage suppression function is enabled only when you operate immediately below the maximum frequency. Overvoltage suppression does not increase the output frequency to more than the maximum frequency. Make sure that the motor and machine specifications are correct for the application, then increase the maximum frequency.
- If there is a sudden increase to a regenerative load, *ov* can occur.

■ L3-01: Stall Prevention during Accel

No. (Hex.)	Name	Description	Default (Range)
L3-01 (048F)	Stall Prevention during Accel	<input type="checkbox"/> V/f <input type="checkbox"/> CL-V/f <input type="checkbox"/> OLV <input type="checkbox"/> CLV <input type="checkbox"/> AOLV <input type="checkbox"/> OLVP/M <input type="checkbox"/> AOLVP/M <input type="checkbox"/> CLVP/M <input type="checkbox"/> EZOLV Sets the method of the Stall Prevention During Acceleration.	1 (0 - 3)

Note:

When $A1-02 = 5$ [Control Method Selection = OLV/PM], the setting range is 0 and 1.

Stall prevention during acceleration prevents the stalling and stopping of motors when oC [Overcurrent], $oL2$ [Drive Overloaded], or $oL1$ [Motor Overload] is detected in cases of significant loads applied during acceleration or sudden acceleration times regarding load inertia are set.

0 : Disabled

The Stall Prevention function does not operate during acceleration, and acceleration occurs for the set acceleration time. If the acceleration time is too short, the motor will not fully accelerate during the set time, which causes the drive to detect $oL1$ or $oL2$ and the motor to stop.

1 : Enabled

Enables the Stall Prevention During Acceleration function. Operation is different for different control methods.

• **V/f Control, Open Loop Vector Control, or EZ Open Loop Vector Control**

When the output current is more than the value set in $L3-02$ [Stall Prevent Level during Accel], the drive stops acceleration. Deceleration is stopped once the output current falls below the value set in $L3-02 - 15\%$. The Stall Prevention function level automatically falls for constant output ranges.

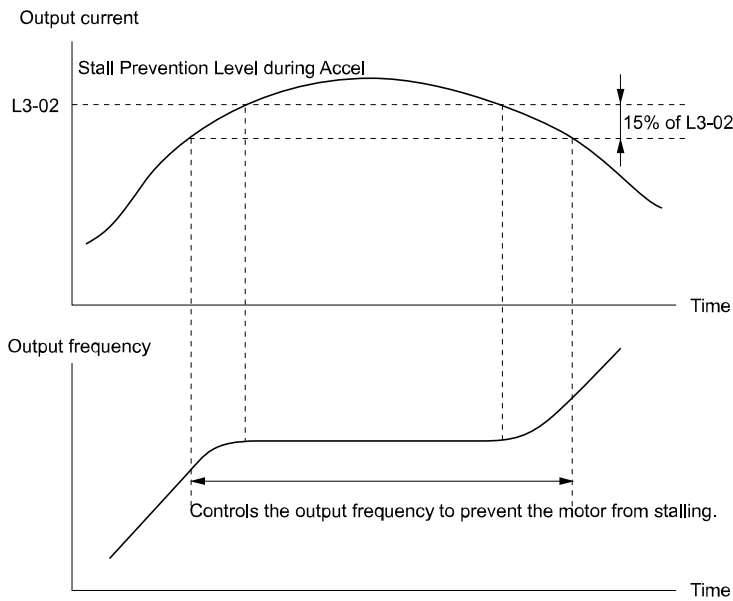

Figure 12.130 Stall Prevention During Acceleration when Using Induction Motors

• **Open Loop Vector Control for PM**

When the output current is more than the value set in $L3-02$, the drive stops acceleration. When the time set in $L3-27$ [Stall Prevention Detection Time] is expired and the output current is larger than in $L3-02$, the drive will start deceleration in as specified by $L3-22$ [PM Stall Prevention Decel Time]. The drive starts acceleration again once the output current falls below the value set in $L3-02 - 15\%$. When the time set in $L3-27$ is expired, the drive starts acceleration again.

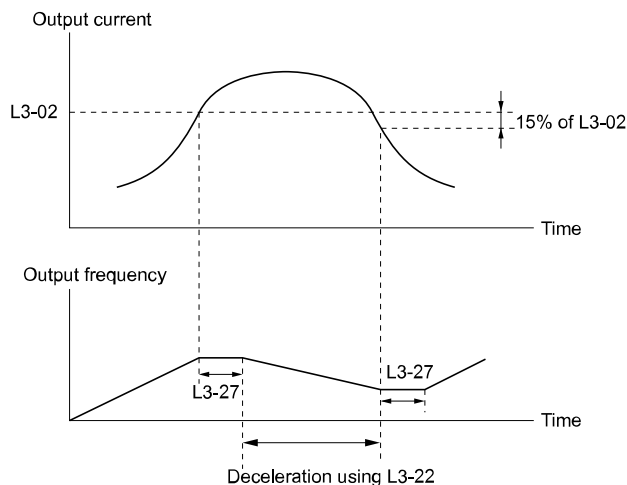

Figure 12.131 Stall Prevention During Acceleration Function in OLV/PM

2 : Intelligent (Ignore Decel Ramp)

The drive ignores the acceleration time setting and the drive starts to accelerate in the minimum length of time. The drive automatically adjusts the acceleration rate to make sure that the output current is not more than L3-02.

3 : Current Limit Acceleration

This function uses the L3-02 value to limit the output current and automatically adjusts the acceleration rate. When the load (output current) increases to more than the current limit level during acceleration, the drive automatically adjusts the acceleration rate.

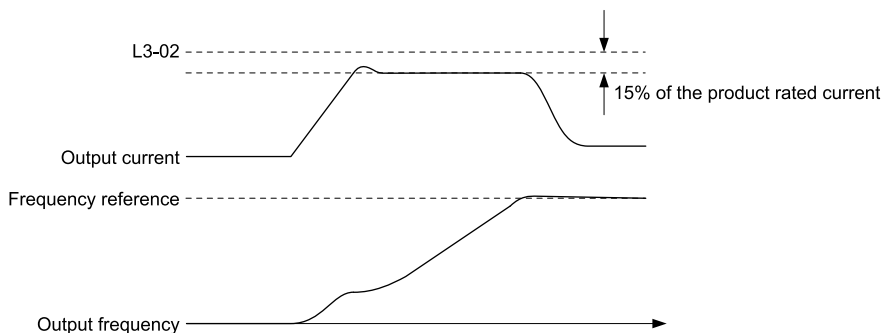

Figure 12.132 Current Limit Acceleration

■ L3-02: Stall Prevent Level during Accel

No. (Hex.)	Name	Description	Default (Range)
L3-02 (0490)	Stall Prevent Level during Accel	V/f CL-V/f OLV CLV AOLV OLV/PM AOLV/PM CLV/PM EZOLV Sets the output current level to activate the Stall Prevention function during acceleration as a percentage of the drive rated output current.	Determined by C6-01 and L8-38 (0 - 150%)

Note:

- If you use a motor that is small compared to the drive and the motor stalls, decrease the setting value.
- When you operate the motor in the constant power range, set L3-03 [Stall Prevent Limit during Accel].
- The upper limit of the setting range changes when C6-01 [Normal / Heavy Duty Selection] changes.
 - 150% when C6-01 = 0 [Heavy Duty Rating].
 - 110% when C6-01 = 1 [Normal Duty Rating].

■ L3-03: Stall Prevent Limit during Accel

No. (Hex.)	Name	Description	Default (Range)
L3-03 (0491)	Stall Prevent Limit during Accel	V/f CL-V/f OLV CLV AOLV OLV/PM AOLV/PM CLV/PM EZOLV Sets the lower limit for the stall prevention level used in the constant output range as a percentage of the drive rated output current.	50% (0 - 100%)

The stall prevention level set in *L3-02 [Stall Prevent Level during Accel]* is automatically reduced when the motor is running within the constant output range. Parameter *L3-03* is the limit value used to prevent the stall prevention level during constant output ranges to fall below the minimum required level.

Note:

The function to automatically reduce the stall prevention level does not operate when *L3-01 = 3 [Stall Prevention during Accel = Current Limit Method]*.

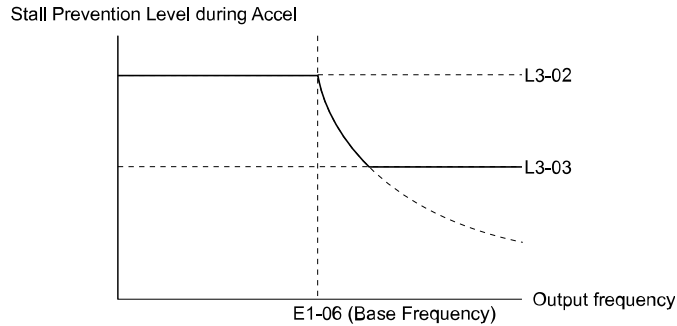

Figure 12.133 Stall Prevent Level during Accel/Limit

■ **L3-04: Stall Prevention during Decel**

No. (Hex.)	Name	Description	Default (Range)
L3-04 (0492)	Stall Prevention during Decel	V/f CL-V/f OLV CLV AOLV OLV/PM AOLV/PM CLV/PM EZOLV Sets the method that the drive will use to prevent overvoltage faults when decelerating.	1 (Determined by A1-02)

Note:

- To connect a dynamic braking option (braking resistor or braking resistor unit) to the drive, set this parameter to 0 or 3. Parameter values 1, 2, 4, and 5 will enable Stall Prevention function during deceleration, and the dynamic braking option will not function.
- The setting range changes when the *A1-02 [Control Method Selection]* value changes:
 - When *A1-02 = 5 [OLV/PM]*, the setting range is 0 to 2.
 - When *A1-02 = 6, 7, 8 [AOLV/PM, CLV/PM, EZOLV]*, the setting range is 0, 1.

Stall Prevention during deceleration controls the deceleration as specified by the DC bus voltage and does not let high inertia or fast deceleration cause *ov [Overvoltage]* faults.

0 : No

The drive decelerates as specified by the deceleration time. If the deceleration time is too short, the drive can detect an *ov* fault.

Note:

If an *ov* fault occurs, connect a dynamic braking option to the drive. If an *ov* fault occurs after you connect a dynamic braking option and *A1-02 = 0 or 2 [Control Method Selection = V/f or CLV]* and *L3-04 = 0*, set *L3-04 = 3*.

1 : General Purpose

The drive decelerates as specified by the deceleration time. When the DC bus voltage is more than the Stall Prevention level, the drive stops deceleration until the DC bus voltage is less than the Stall Prevention Level. The drive then starts to decelerate at the set deceleration time. Frequent use of Stall Prevention will help prevent *ov* faults when the deceleration time is shorter than the drive can usually accept.

Note:

The Decel Stall Prevention function will increase the deceleration time to stop and the deceleration time will be longer than the setting. This function is not applicable for conveyor applications because the precision of the stop position is very important. As an alternative, use a dynamic braking option in these applications.

The input voltage setting of *E1-01 [Input AC Supply Voltage]* sets the DC bus voltage level for Stall Prevention.

Table 12.68 Stall Prevention Level during Deceleration

Drive Input Voltage	Stall Prevention Level during Deceleration
200 V class	377 V
400 V class	754 V

Figure 12.134 shows the Stall Prevention during deceleration function.

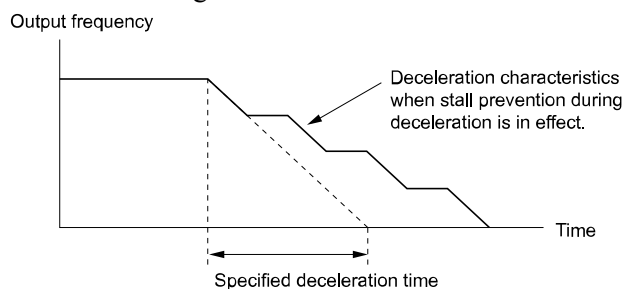

Figure 12.134 Stall Prevention Operation during Deceleration

2 : Intelligent (Ignore Decel Ramp)

The drive adjusts the deceleration rate to keep the DC bus voltage at the *L3-17 [DC Bus Regulation Level]* level. This makes the shortest possible deceleration time and will not let the motor stall. The drive ignores the selected deceleration time and the possible deceleration time cannot be less than 1/10 of the set deceleration time.

This function uses these parameters to adjust the deceleration rate:

- *L3-20 [DC Bus Voltage Adjustment Gain]*
- *L3-21 [OVSuppression Accel/Decel P Gain]*
- *L3-24 [Motor Accel Time @ Rated Torque]*
- *L3-25 [Load Inertia Ratio]*

Note:

The deceleration time is not constant. For applications where the precision of the stop position is very important, use a dynamic braking option and set *L3-04 = 0*. If an *ov* occurs, set *L3-04 = 3*.

3 : General Purpose w/ DB resistor

A braking resistor is necessary for this setting. The braking resistor and the drive work together for the Stall Prevention during deceleration function.

4 : Overexcitation/High Flux

Enables Overexcitation/High Flux and enables a shorter deceleration time than when *L3-04 = 0*.

Note:

- If the overexcitation time is long and you decelerate frequently, the drive can detect *oL1 [Motor Overload]* faults. If the drive detects *oL1*, decrease the deceleration time or install a braking resistor to the drive.
- The deceleration time during Overexcitation Deceleration changes when the motor characteristics and machine inertia change. Adjust the *n3-13 [OverexcitationBraking (OEB) Gain]* and *n3-23 [Overexcitation Braking Operation]* levels. Refer to “n3: HighSlip/OverexciteBraking” for more information about the overexcitation function.

5 : Overexcitation/High Flux 2

Enables Overexcitation/High Flux 2. This function decreases the possible deceleration time more than Overexcitation/High Flux.

The drive decreases motor speed and tries to keep the DC bus voltage at the *L3-17* level.

If the drive detects *oL1*, decrease the values set in *n3-13* and *n3-21*. If the drive detects *ov*, increase the values set in *C1-02*, *C1-04*, *C1-06*, and *C1-08 [Deceleration Times]*.

Note:

- During Overexcitation/High Flux 2, the drive disables Hunting Prevention in V/f Control and also disables Speed Control that uses torque limit in OLV Control.
- Refer to “n3: HighSlip/OverexciteBraking” for more information about the overexcitation function.

■ L3-05: Stall Prevention during RUN

No. (Hex.)	Name	Description	Default (Range)
L3-05 (0493)	Stall Prevention during RUN	<input checked="" type="checkbox"/> V/f <input checked="" type="checkbox"/> CL-V/f <input type="checkbox"/> OLV <input type="checkbox"/> CLV <input type="checkbox"/> AOLV <input checked="" type="checkbox"/> OLV/PM <input type="checkbox"/> AOLV/PM <input type="checkbox"/> CLV/PM <input checked="" type="checkbox"/> EZOLV Sets the function to enable and disable Stall Prevention During Run.	2 (0 - Determined by A1-02)

Stall Prevention function during run prevents the motor from stalling by automatically reducing the speed when an *oL1* [*Motor Overload*] occurs while the motor is running at constant speed.

Note:

1. An output frequency lower than 6 Hz will disable Stall Prevention during Run. The *L3-05* and *L3-06* [*Stall Prevent Level during Run*] settings do not have an effect.
2. The setting range changes when *A1-02* [*Control Method*] changes:
 - *A1-02* = 0, 1, 5 [*V/f*, *CL-V/f*, *OLV/PM*]: 0 to 2
 - *A1-02* = 8 [*EZOLV*]: 0, 3

0 : Disabled

The drive runs at the set frequency reference. A heavy load can cause the drive to detect *oC* [*Overcurrent*] or *oL1* and stall the motor.

1 : Deceleration Time 1 (C1-02)

The drive will decelerate for the time set in *C1-02* [*Deceleration Time 1*] when the current is more than the Stall Prevention level set in *L3-06*. When the current level is less than the “*L3-06* setting value - 2%” for 100 ms, the drive accelerates again for the acceleration time applicable at that time until it reaches the set frequency.

2 : Deceleration Time 2 (C1-04)

This setting functions the same as *Setting 1* [*Deceleration Time 1 (C1-02)*]. When the Stall Prevention function is enabled, the drive decelerates with the value set in *C1-04* [*Deceleration Time 2*].

3 : Intelligent (Ignore Decel Ramp)

Available when *A1-02* = 8 [*EZOLV*]. The drive operates with the largest possible output and prevents motor stalling.

■ L3-06: Stall Prevent Level during Run

No. (Hex.)	Name	Description	Default (Range)
L3-06 (0494)	Stall Prevent Level during Run	<div style="display: flex; justify-content: space-between; font-size: small;"> V/f CL-V/f OLV CLV AOLV OLV/PM AOLV/PM CLV/PM EZOLV </div> <p>Sets the output current level to enable the Stall Prevention function during operation as a percentage of the drive rated output current.</p>	Determined by C6-01 and L8-38 (5 - 150%)

Note:

- This parameter is applicable when *L3-05* = 1, 2 [*Stall Prevention during RUN = Deceleration Time 1 (C1-02), Deceleration Time 2 (C1-04)*].
- When *L3-23* = 1 [*Stall P Reduction at Constant HP = Automatic Reduction @ CHP Region*], the drive will automatically decrease the level in the constant output range.
- The upper limit of the setting range changes when *C6-01* [*Normal / Heavy Duty Selection*] changes.
 - 150% when *C6-01* = 0 [*Heavy Duty Rating (HD) for Constant Torque Applications*].
 - 110% when *C6-01* = 1 [*Normal Duty Rating (ND) for Variable Torque Applications*].

Use an Analog Input to Change the Stall Prevent Level during Run

When *H3-xx* = 8 [*MFAI Function Select = Stall Prevent Level During Run*], you can change the stall prevention level during run through the input gain and bias settings for terminals A1, A2, and A3.

If you set the input level for *terminals A1, A2, and A3* [*H3-xx* = 8] and *L3-06*, the drive will use the smaller value for Stall Prevent Level during Run.

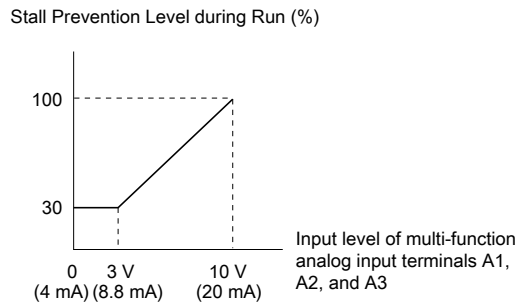

Figure 12.135 Stall Prevention Level during Run with Analog Input

■ L3-11: Overvoltage Suppression Select

No. (Hex.)	Name	Description	Default (Range)
L3-11 (04C7)	Overvoltage Suppression Select	V/f CL-V/f OLV CLV AOLV OLV/PM AOLV/PM CLV/PM EZOLV Sets the overvoltage suppression function.	0 (0, 1)

0 : Disabled

The drive does not adjust the regenerative torque limit or the output frequency. If you apply a regenerative load, the drive can detect an *ov* [Overvoltage] fault. Use this setting with a dynamic braking option.

1 : Enabled

When a regenerative load increases the DC bus voltage, the drive decreases the regenerative torque limit and increases the output frequency to prevent *ov*

■ L3-17: DC Bus Regulation Level

No. (Hex.)	Name	Description	Default (Range)
L3-17 (0462)	DC Bus Regulation Level	V/f CL-V/f OLV CLV AOLV OLV/PM AOLV/PM CLV/PM EZOLV Sets the target value for the DC bus voltage when the overvoltage suppression function and the Decel Stall Prevention function (Intelligent Stall Prevention) are active.	200 V Class: 375 V, 400 V: 750 V (200 V Class: 150 to 400 V, 400 V Class: 300 to 800 V)

Note:

This value is initialized when *E1-01* [Input AC Supply Voltage] is changed.

Sets this parameter for any of the following circumstances.

- *L3-11 = 1* [OV Suppression Function Select = Enabled].
- *L3-04 = 2* [Decel Stall Prevention Selection = Automatic Decel Reduction].

■ L3-20: DC Bus Voltage Adjustment Gain

No. (Hex.)	Name	Description	Default (Range)
L3-20 (0465) Expert	DC Bus Voltage Adjustment Gain	V/f CL-V/f OLV CLV AOLV OLV/PM AOLV/PM CLV/PM EZOLV Sets the proportional gain used to control the DC bus voltage.	Determined by A1-02 (0.00 - 5.00)

Set one of these parameters to enable L3-20:

- *L2-29 = 1* [KEB Method Selection = Single Drive KEB Ride-Thru 2]
- *L3-04 = 2* [Decel Stall Prevention Selection = Automatic Decel Reduction]
- *L3-11 = 1* [OV Suppression Function Select = Enabled]
- *H1-xx = 7A or 7B* [MFDI Function Select = KEB Ride-Thru 2 (N.O./N.C.)]

Note:

- If stall prevention during deceleration function causes *ov* [Overvoltage] and *Uv1* [DC Bus Undervoltage] faults when you start deceleration and *L2-29 = 1*, *H1-xx = 7A or 7B*, or *L3-04 = 2*, gradually increase this parameter in 0.1-unit increments. If the setting value is too high, it can cause large speed or current ripples.
- If sudden increases in the regenerative load cause *ov* faults and *L3-11 = 1*, gradually increase this parameter in 0.1-unit increments. If the setting value is too high, it can cause large speed or current ripples.

■ L3-21: OVSsuppression Accel/Decel P Gain

No. (Hex.)	Name	Description	Default (Range)
L3-21 (0466) Expert	OVSsuppression Accel/Decel P Gain	V/f CL-V/f OLV CLV AOLV OLV/PM AOLV/PM CLV/PM EZOLV Sets the proportional gain to calculate acceleration and deceleration rates.	Determined by A1-02 (0.10 - 10.00)

Set one of these parameters to enable L3-21:

- *L2-29 = 1* [KEB Method Selection = Single Drive KEB Ride-Thru 2]
- *L3-04 = 2* [Decel Stall Prevention Selection = Automatic Decel Reduction]

12.9 L: Protection Functions

- $L3-11 = 1$ [*OV Suppression Function Select = Enabled*]
- $H1-xx = 7A$ or $7B$ [*MFDI Function Select = KEB Ride-Thru 2 (N.O./N.C.)*]

Note:

- If stall prevention during deceleration function causes large speed or current ripples and $L2-29 = 1$, $H1-xx = 7A$ or $7B$, or $L3-04 = 2$, gradually decrease this parameter in 0.05-unit increments. If the drive detects *ov* [*Overvoltage*] or *oC* [*Overcurrent*], decrease this parameter. If you decrease the gain too much, it can cause a delay in control in the DC bus voltage or the deceleration time could be longer than the best deceleration time.
- If sudden increases in the regenerative load cause *ov* faults and $L3-11 = 1$, gradually increase this parameter in 0.1-unit increments. If there are large speed ripples, gradually decrease this parameter in 0.05-unit increments.

■ L3-22: PM Stall Prevention Decel Time

No. (Hex.)	Name	Description	Default (Range)
L3-22 (04F9)	PM Stall Prevention Decel Time	<div style="display: flex; justify-content: space-between; align-items: center;"> V/f CL-V/f OLV CLV AOLV OLV/PM AOLV/PM CLV/PM EZOLV </div> <p>Sets the momentary deceleration time that the drive will use when it tries to accelerate a PM motor and detected motor stalls. This function is applicable when $L3-01 = 1$ [<i>Stall Prevent Select duringAccel = General Purpose</i>].</p>	0.0 s (0.0 - 6000.0 s)

Set this parameter to 0.0 s to disable this function. The drive will decelerates in the deceleration time applicable at the time when a motor stall occurs.

■ L3-23: Stall P Reduction at Constant HP

No. (Hex.)	Name	Description	Default (Range)
L3-23 (04FD)	Stall P Reduction at Constant HP	<div style="display: flex; justify-content: space-between; align-items: center;"> V/f CL-V/f OLV CLV AOLV OLV/PM AOLV/PM CLV/PM EZOLV </div> <p>Sets the function to automatically decrease the Stall Prevention Level during Run for constant output ranges.</p>	0 (0, 1)

0 : Use L3-06 for Entire Speed Range

The drive uses the level set in $L3-06$ [*Stall Prevent Level during Run*] through the full speed range.

1 : Automatic Reduction @ CHP Region

The drive decreases the Stall Prevention level during run in the constant power range. The lower limit is 40% of the $L3-06$ value.

■ L3-24: Motor Accel Time @ Rated Torque

No. (Hex.)	Name	Description	Default (Range)
L3-24 (046E) Expert	Motor Accel Time @ Rated Torque	<div style="display: flex; justify-content: space-between; align-items: center;"> V/f CL-V/f OLV CLV AOLV OLV/PM AOLV/PM CLV/PM EZOLV </div> <p>Sets the motor acceleration time to reach the maximum frequency at the motor rated torque for stopped single-drive motors.</p>	Determined by o2-04, C6-01, E2-11, and E5-01 (0.001 - 10.000 s)

Set one of these parameters to enable L3-20:

- $L2-29 = 1$ [*Kinetic Energy Backup Method = Single Drive KEB Ride-Thru 2*]
- $L3-04 = 2$ [*Stall Prevention during Decel = Intelligent (Ignore Decel Ramp)*]
- $L3-11 = 1$ [*Overvoltage Suppression Select = Enabled*]
- $H1-xx = 7A$ or $7B$ [*MFDI Function Selection = KEB Ride-Thru 2 Activate (N.O./N.C.)*]

Note:

When Auto-Tuning changes the value of $E2-11$ [*Motor Rated Power*], the drive will automatically set $L3-24$ to the value for a Yaskawa standard motor (4 poles). When you use a PM motor, the drive uses the value in $E5-01$ [*PM Motor Code Selection*] to change $L3-24$.

Automatically Adjust Parameters

When $A1-02 = 3, 7$ [*Control Method Selection = CLV, CLV/PM*], do Inertia Tuning. Parameters are automatically adjusted.

Manually Adjust Parameters

Use this formula to find the motor acceleration time:

$$L3-24 = \frac{2\pi \cdot J_{\text{Motor}} \cdot n_{\text{rated}}}{60 \cdot T_{\text{rated}}}$$

- J_{Motor} = Moment of inertia of motor (kg m²)
- n_{rated} = Motor rated speed (min⁻¹, r/min)
- T_{rated} = Motor rated torque (N·m)

The rated torque is calculated using the following expression.

$$T_{rated} = \frac{60 \cdot P_{Motor} \cdot 10^3}{2\pi \cdot n_{rated}}$$

P_{Motor} = Motor Rated Power (kW)

■ L3-25: Load Inertia Ratio

No. (Hex.)	Name	Description	Default (Range)
L3-25 (046F) Expert	Load Inertia Ratio	<div style="display: flex; justify-content: space-between; font-size: 0.8em;"> V/f CL-V/f OLV CLV AOLV OLV/PM AOLV/PM CLV/PM EZOLV </div> <p>Sets the ratio between motor inertia and machine inertia.</p>	1.0 (0.1 - 1000.0)

Set one of these parameters to enable L3-20:

- $L2-29 = 1$ [*Kinetic Energy Backup Method = Single Drive KEB Ride-Thru 2*]
- $L3-04 = 2$ [*Stall Prevention during Decel = Intelligent (Ignore Decel Ramp)*]
- $L3-11 = 1$ [*Overvoltage Suppression Select= Enabled*]
- $H1-xx = 7A$ or $7B$ [*MFDI Function Selection = KEB Ride-Thru 2 Activate (N.O./N.C.)*]

Note:

- If you set this value incorrectly when $L2-29 = 1$, $H1-xx = 7A$ or $7B$, or $L3-11 = 1$, it can cause large current ripples and *ov* [Overvoltage], *Uv1* [DC Bus Undervoltage], or *oC* [Overcurrent] faults.
- KEB Tuning will automatically set this value.

Automatically Adjust Parameters

When $A1-02 = 3, 7$ [*Control Method Selection = CLV, CLV/PM*], do Inertia Tuning. Parameters are automatically adjusted.

Manually Adjust Parameters

Use this formula to find the load inertia ratio:

$$\text{Load inertia ratio} = \frac{\text{Machine inertia (Motor shaft conversion value)}}{\text{Motor inertia}}$$

■ L3-26: Additional DC Bus Capacitors

No. (Hex.)	Name	Description	Default (Range)
L3-26 (0455) Expert	Additional DC Bus Capacitors	<div style="display: flex; justify-content: space-between; font-size: 0.8em;"> V/f CL-V/f OLV CLV AOLV OLV/PM AOLV/PM CLV/PM EZOLV </div> <p>Sets the capacity for external main circuit capacitors. Usually it is not necessary to change this setting. Sets this parameter when you use the KEB Ride-Thru function.</p>	0 μF (0 to 65000 μF)

■ L3-27: Stall Prevention Detection Time

No. (Hex.)	Name	Description	Default (Range)
L3-27 (0456)	Stall Prevention Detection Time	<div style="display: flex; justify-content: space-between; font-size: 0.8em;"> V/f CL-V/f OLV CLV AOLV OLV/PM AOLV/PM CLV/PM EZOLV </div> <p>Sets a delay time between reaching the Stall Prevention level and starting the Stall Prevention function.</p>	50 ms (0 - 5000 ms)

■ L3-34: Torque Limit Delay Time

No. (Hex.)	Name	Description	Default (Range)
L3-34 (016F) Expert	Torque Limit Delay Time	<div style="display: flex; justify-content: space-between; font-size: 0.8em;"> V/f CL-V/f OLV CLV AOLV OLV/PM AOLV/PM CLV/PM EZOLV </div> <p>Sets the filter time constant that returns the torque limit to its initial value when KEB operation operates in Single Drive KEB Ride-Thru mode.</p>	Determined by A1-02 (0.000 - 1.000 s)

When vibration occurs during operation of Single Drive KEB Ride-Thru 2, increase this parameter in 0.010-unit increments.

Note:

The Single Drive KEB Ride-Thru 2 mode operates when $L2-29 = 1$ [KEB Method Selection = Single Drive KEB Ride-Thru 2] and $H1-xx = 7A$ or $7B$ [Terminal Sx Function Selection = KEB Ride-Thru 2 (N.C./N.O.)].

■ **L3-35: Speed Agree Width for Auto Decel**

No. (Hex.)	Name	Description	Default (Range)
L3-35 (0747) Expert	Speed Agree Width for Auto Decel	<div style="display: flex; justify-content: space-between; font-size: 0.8em; font-weight: bold;"> V/f CL-V/f OLV CLV AOLV OLV/PM AOLV/PM CLV/PM EZOLV </div> <p>Sets the width for speed agreement when $L3-04 = 2$ [Decel Stall Prevention Selection = Automatic Decel Reduction]. Usually it is not necessary to change this setting.</p>	0.00 Hz (0.00 - 1.00 Hz)

Set this parameter when hunting occurs while you use a frequency reference through an analog input.

■ **L3-36: Current Suppression Gain@Accel**

No. (Hex.)	Name	Description	Default (Range)
L3-36 (11D0)	Current Suppression Gain@Accel	<div style="display: flex; justify-content: space-between; font-size: 0.8em; font-weight: bold;"> V/f CL-V/f OLV CLV AOLV OLV/PM AOLV/PM CLV/PM EZOLV </div> <p>Sets the gain to suppress current and motor speed hunting during operation when $L3-01 = 3$ [Stall Prevention during Accel = Current Limit Method]. Usually it is not necessary to change this setting.</p>	Determined by A1-02 (0.0 - 100.0)

If there is vibration in the output current during acceleration, increase the setting value.

Note:

Set $L3-01 = 3$ [Stall Prevention during Accel = Current Limit Method] to enable this function.

■ **L3-37: Current Limit P Gain @ Accel**

No. (Hex.)	Name	Description	Default (Range)
L3-37 (11D1) Expert	Current Limit P Gain @ Accel	<div style="display: flex; justify-content: space-between; font-size: 0.8em; font-weight: bold;"> V/f CL-V/f OLV CLV AOLV OLV/PM AOLV/PM CLV/PM EZOLV </div> <p>Suppresses current hunting during acceleration. Usually it is not necessary to change this setting.</p>	5 ms (0 - 100 ms)

Note:

Set $L3-01 = 3$ [Stall Prevention during Accel = Current Limit Method] to enable this function.

■ **L3-38: Current Limit I Time @ Accel**

No. (Hex.)	Name	Description	Default (Range)
L3-38 (11D2) Expert	Current Limit I Time @ Accel	<div style="display: flex; justify-content: space-between; font-size: 0.8em; font-weight: bold;"> V/f CL-V/f OLV CLV AOLV OLV/PM AOLV/PM CLV/PM EZOLV </div> <p>Suppresses current hunting and overshooting that occurs when the drive stalls during acceleration. Usually it is not necessary to change this setting.</p>	10.0 (0.0 - 100.0)

Note:

Set $L3-01 = 3$ [Stall Prevention during Accel = Current Limit Method] to enable this function.

■ **L3-39: Current Limit Filter Time @Accel**

No. (Hex.)	Name	Description	Default (Range)
L3-39 (11D3)	Current Limit Filter Time @Accel	<div style="display: flex; justify-content: space-between; font-size: 0.8em; font-weight: bold;"> V/f CL-V/f OLV CLV AOLV OLV/PM AOLV/PM CLV/PM EZOLV </div> <p>Sets the time constant to adjust the acceleration rate when $L3-01 = 3$ [Stall Prevention during Accel = Current Limit Method]. Usually it is not necessary to change this setting.</p>	100.0 ms (1.0 - 1000.0 ms)

Note:

Set $L3-01 = 3$ [Stall Prevention during Accel = Current Limit Method] to enable this function.

■ L3-40: Current Limit S-Curve @ Acc/Dec

No. (Hex.)	Name	Description	Default (Range)
L3-40 (11D4)	Current Limit S-Curve @ Acc/Dec	<div style="display: flex; justify-content: space-between; align-items: center;"> V/f CL-V/f OLV CLV AOLV OLV/PM AOLV/PM CLV/PM EZOLV </div> <p>Sets the function to enable and disable the best S-curve characteristic used for current-limited acceleration.</p>	0 (0, 1)

Makes the best motor acceleration rate for start up. If you set this parameter to 1, it will make acceleration smoother, but it can also increase the acceleration time to be longer than the set time. If the drive detects *oC* [*Overcurrent*] faults immediately after acceleration starts, set this parameter.

0 : No

1 : Yes

Note:

Set *L3-01 = 3* [*Stall Prevention during Accel = Current Limit Method*] to enable this function.

◆ L4: Speed Detection

L4 parameters set the output of signals to the MFDO terminals, for example frequency agree and speed detection. The drive detects motor speed in CLV or CLV/PM control methods.

■ L4-01: Speed Agree Detection Level

No. (Hex.)	Name	Description	Default (Range)
L4-01 (0499)	Speed Agree Detection Level	<div style="display: flex; justify-content: space-between; align-items: center;"> V/f CL-V/f OLV CLV AOLV OLV/PM AOLV/PM CLV/PM EZOLV </div> <p>Sets the level to detect speed agree or motor speed.</p>	Determined by A1-02 (Determined by A1-02)

Sets the level to detect speed agree or motor speed when *H2-01 to H2-03 = 2, 3, 4, 5* [*MFDO Function Select = Speed Agree 1, User-set Speed Agree 1, Frequency Detection 1, Frequency Detection 2*].

■ L4-02: Speed Agree Detection Width

No. (Hex.)	Name	Description	Default (Range)
L4-02 (049A)	Speed Agree Detection Width	<div style="display: flex; justify-content: space-between; align-items: center;"> V/f CL-V/f OLV CLV AOLV OLV/PM AOLV/PM CLV/PM EZOLV </div> <p>Sets the width to detect speed agree or motor speed.</p>	Determined by A1-02 (Determined by A1-02)

Sets the width to detect speed agree or motor speed when *H2-01 to H2-03 = 2, 3, 4, 5* [*MFDO Function Select = Speed Agree 1, User-set Speed Agree 1, Frequency Detection 1, Frequency Detection 2*].

■ L4-03: Speed Agree Detection Level (+/-)

No. (Hex.)	Name	Description	Default (Range)
L4-03 (049B)	Speed Agree Detection Level (+/-)	<div style="display: flex; justify-content: space-between; align-items: center;"> V/f CL-V/f OLV CLV AOLV OLV/PM AOLV/PM CLV/PM EZOLV </div> <p>Sets the level to detect speed agree or motor speed.</p>	Determined by A1-02 (Determined by A1-02)

Sets the speed agree detection level or motor speed detection level when *H2-01 to H2-03 = 13, 14, 15, 16* [*MFDO Function Selection = Speed Agree 2, User-set Speed Agree 2, Frequency Detection 3, Frequency Detection 4*].

■ L4-04: Speed Agree Detection Width (+/-)

No. (Hex.)	Name	Description	Default (Range)
L4-04 (049C)	Speed Agree Detection Width (+/-)	<div style="display: flex; justify-content: space-between; align-items: center;"> V/f CL-V/f OLV CLV AOLV OLV/PM AOLV/PM CLV/PM EZOLV </div> <p>Sets the width to detect speed agree or motor speed.</p>	Determined by A1-02 (Determined by A1-02)

Sets the width to detect speed agree or motor speed when *H2-01 to H2-03 = 13, 14, 15, 16* [*MFDO Function Selection = Speed Agree 2, User-set Speed Agree 2, Frequency Detection 3, Frequency Detection 4*].

■ **L4-05: Fref Loss Detection Selection**

No. (Hex.)	Name	Description	Default (Range)
L4-05 (049D)	Fref Loss Detection Selection	<div style="display: flex; justify-content: space-between; font-size: small;"> V/f CL-V/f OLV CLV AOLV OLV/PM AOLV/PM CLV/PM EZOLV </div> Sets the operation when the drive detects a loss of frequency reference.	0 (0, 1)

Enables the detection of a loss of an analog frequency reference when the frequency reference is input from the MFAI terminals (A1, A2, and A3). Set $H2-01$ to $H2-03 = C$ [*MFDO Function Select = Frequency Reference Loss*] to enable this function.

If the frequency reference is less than 10% in 400 ms, the drive detects frequency reference loss.

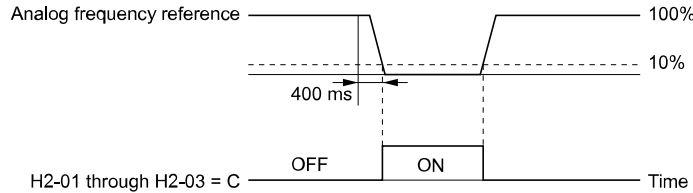

Figure 12.136 Detection of Frequency Reference Loss

0 : Stop

The drive follows the frequency reference and stops the motor.

1 : Run at (L4-06 x Last Reference)

The drive continues to operate at the frequency reference value set in *L4-06* [*FreqReference at Reference Loss*]. When you return the external frequency reference value, the drive continues to operate with the frequency reference.

■ **L4-06: Frequency Reference @Loss of Ref**

No. (Hex.)	Name	Description	Default (Range)
L4-06 (04C2)	Frequency Reference @Loss of Ref	<div style="display: flex; justify-content: space-between; font-size: small;"> V/f CL-V/f OLV CLV AOLV OLV/PM AOLV/PM CLV/PM EZOLV </div> Sets the frequency reference as a percentage to continue drive operation after it detects a frequency reference loss. The value is a percentage of the frequency reference before the drive detected the loss.	80.0% (0.0 - 100.0%)

Set $L4-05 = 1$ [*FreqReference Loss Detect Select = Run@L4-06PrevRef*] to enable this parameter.

■ **L4-07: Speed Agree Detection Selection**

No. (Hex.)	Name	Description	Default (Range)
L4-07 (0470)	Speed Agree Detection Selection	<div style="display: flex; justify-content: space-between; font-size: small;"> V/f CL-V/f OLV CLV AOLV OLV/PM AOLV/PM CLV/PM EZOLV </div> Sets the condition that activates speed detection.	0 (0, 1)

0 : No Detection during Baseblock

Detects the frequency while the drive is operating. When the drive turns off its output, it will not detect frequency.

1 : Detection Always Enabled

◆ **L5: Fault Restart**

The Auto Restart function tries to keep machines operating when the drive detects a transient fault.

The drive can do a self-diagnostic check and continue the operation after a fault. If the cause of the fault goes away, the drive does speed search and restarts. It will not stop and the drive will not record a fault history. Use *L5-02* [*Fault Contact at Restart Select*] to select the operation of fault relay signals during Auto Restart operation.

Sets if the drive will do Auto Restart and the number of times the drive will try to do Auto Restart in a set time. If the number of Auto Restart tries is more than the set value during the set time, drive output shuts off and operation stops. If this happens, remove the cause of the fault and manually restart the drive.

The drive can do Auto Restart when these faults occur:

Note:

You can disable Auto Restart for faults if you must not restart the machine after the fault.

Table 12.69 List of Faults during which Auto Restart is Available

Fault	Name	Parameters to Disable Auto Restart	Fault	Name	Parameters to Disable Auto Restart
GF	Ground Fault	L5-08	ov	Oversvoltage	L5-08
LF	Output Phase Loss	-	PF	Input Phase Loss	-
oC	Overcurrent	-	rH	Braking Resistor Overheat	-
oH1	Heatsink Overheat	L5-08	rr	Dynamic Braking Transistor Fault	-
oL1	Motor Overload	L5-07	STPo	Motor Step-Out Detected	-
oL2	Drive Overload	L5-07	Uv1	DC Bus Undervoltage ^{*1}	L5-08
oL3	Overtorque Detection 1	L5-07			
oL4	Overtorque Detection 2	L5-07			

*1 Uv1 is the target for the auto restart process when L2-01 = 1, 2, 3, or 4 [Power Loss Ride Through Select = Enabled for L2-02 Time, Enabled while CPU Power Active, Kinetic Energy Backup: L2-02, or Kinetic Energy Backup: CPU Power].

■ L5-01: Number of Auto-Restart Attempts

No. (Hex.)	Name	Description	Default (Range)
L5-01 (049E)	Number of Auto-Restart Attempts	V/f CL-V/f OLV CLV AOLV OLV/PM AOLV/PM CLV/PM EZOLV Sets the number of times that the drive will try to restart.	0 (0 - 10 times)

The drive resets the number of Auto Restart attempts to 0 in these conditions:

- The drive operates correctly for 10 minutes after a fault restart.
- When you manually clear a fault after the drive triggers protective functions.
- When you re-energize the drive.

■ L5-02: Fault Contact at Restart Select

No. (Hex.)	Name	Description	Default (Range)
L5-02 (049F)	Fault Contact at Restart Select	V/f CL-V/f OLV CLV AOLV OLV/PM AOLV/PM CLV/PM EZOLV Sets the function that sends signals to the MFDO terminal set for Fault [H2-xx = E] while the drive is automatically restarting.	0 (0, 1)

0 : Active Only when Not Restarting

1 : Always Active

■ L5-03: Continuous Method Max Restart T

No. (Hex.)	Name	Description	Default (Range)
L5-03 (04A0)	Continuous Method Max Restart T	V/f CL-V/f OLV CLV AOLV OLV/PM AOLV/PM CLV/PM EZOLV Sets the time for which the drive will try to restart. If the drive cannot restart in the time set in L5-03, the drive detects a fault. This is available when L5-05 = 0 [Auto-Restart Method = Continuous/Immediate Attempts].	10.0 s (0.5 - 180.0 s)

■ L5-04: Interval Method Restart Time

No. (Hex.)	Name	Description	Default (Range)
L5-04 (046C)	Interval Method Restart Time	V/f CL-V/f OLV CLV AOLV OLV/PM AOLV/PM CLV/PM EZOLV Sets the time interval between each Auto Restart attempt. This function is enabled when L5-05 = 1 [Auto Restart Operation Selection = Use L5-04 Time].	10.0 s (0.5 - 600.0 s)

■ **L5-05: Auto-Restart Method**

No. (Hex.)	Name	Description	Default (Range)
L5-05 (0467)	Auto-Restart Method	<div style="display: flex; justify-content: space-between; font-size: small;"> V/f CL-V/f OLV CLV AOLV OLV/PM AOLV/PM CLV/PM EZOLV </div> Sets the count method for the Auto Restart operation.	0 (0, 1)

0 : Continuous/Immediate Attempts

Counts the number of successful fault resets through Auto Restart.

When this value > L5-01, the drive will send a fault signal and fault code to the keypad and the motor will coast to stop.

1 : Interval/Attempt after L5-04 sec

Counts the number of all fault resets (successful and unsuccessful) through Auto Restart. The drive repeats the Auto Restart process in the intervals set in L5-04 [Interval Method Restart Time].

When this value > L5-01, the drive will send a fault signal and fault code to the keypad and the motor will coast to stop.

■ **L5-07: Fault Reset Enable Select Grp1**

No. (Hex.)	Name	Description	Default (Range)
L5-07 (0B2A)	Fault Reset Enable Select Grp1	<div style="display: flex; justify-content: space-between; font-size: small;"> V/f CL-V/f OLV CLV AOLV OLV/PM AOLV/PM CLV/PM EZOLV </div> Use these 4 digits to set the Auto Restart function for oL1 to oL4. From left to right, the digits set oL1, oL2, oL3, and oL4, in order.	1111 (0000 - 1111)

0000 : Disabled

0001 : Enabled (—/—/—/oL4)

0010 : Enabled (—/—/oL3/—)

0011 : Enabled (—/—/oL3/oL4)

0100 : Enabled (—/oL2/—/—)

0101 : Enabled (—/oL2/—/oL4)

0110 : Enabled (—/oL2/oL3/—)

0111 : Enabled (—/oL2/oL3/oL4)

1000 : Enabled (oL1/—/—/—)

1001 : Enabled (oL1/—/—/oL4)

1010 : Enabled (oL1/—/oL3/—)

1011 : Enabled (oL1/—/oL3/oL4)

1100 : Enabled (oL1/oL2/—/—)

1101 : Enabled (oL1/oL2/—/oL4)

1110 : Enabled (oL1/oL2/oL3/—)

1111 : Enabled (oL1/oL2/oL3/oL4)

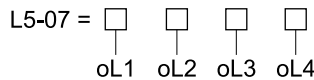

Figure 12.137 Setting Digits and Fault Code

■ **L5-08: Fault Reset Enable Select Grp2**

No. (Hex.)	Name	Description	Default (Range)
L5-08 (0B2B)	Fault Reset Enable Select Grp2	<div style="display: flex; justify-content: space-between; font-size: small;"> V/f CL-V/f OLV CLV AOLV OLV/PM AOLV/PM CLV/PM EZOLV </div> Use these 4 digits to set the Auto Restart function for Uv1, ov, oHI, and GF. From left to right, the digits set Uv1, ov, oHI, and GF, in order.	1111 (0000 - 1111)

0000 : Disabled

0001 : Enabled (—/—/—/GF)
0010 : Enabled (—/—/ovH1/—)
0011 : Enabled (—/—/ovH1/GF)
0100 : Enabled (—/ov/—/—)
0101 : Enabled (—/ov/—/GF)
0110 : Enabled (—/ov/ovH1/—)
0111 : Enabled (—/ov/ovH1/GF)
1000 : Enabled (Uv1/—/—/—)
1001 : Enabled (Uv1/—/—/GF)
1010 : Enabled (Uv1/—/ovH1/—)
1011 : Enabled (Uv1/—/ovH1/GF)
1100 : Enabled (Uv1/ov/—/—)
1101 : Enabled (Uv1/ov/—/GF)
1110 : Enabled (Uv1/ov/ovH1/—)
1111 : Enabled (Uv1/ov/ovH1/GF)

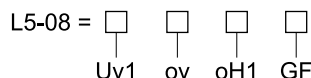

Figure 12.138 Setting Digits and Fault Code

◆ L6: Torque Detection

The overtorque/undertorque detection function prevents damage to machinery and loads.

Overtorque is the when there is too much load on the machine. If the motor current or output torque is at the overtorque detection level for the overtorque detection time, the drive will output an alarm and turn off the output.

Undertorque is the when a load suddenly decreases. When the motor current or output torque is at the undertorque detection level for the undertorque detection time, the drive will output an alarm and turn off the output.

You can use the undertorque detection function to detect these conditions, for example:

- Machine belt cuts
- Unusual operation of the electromagnetic contactor on the drive output side
- Clogged output side air filters in fans and blowers
- Damage to blade tips and broken string

Note:

If there is *oC* [Overcurrent] or *oL1* [Motor Overload], the drive can stop during overtorque conditions. Use torque detection to identify overload conditions before the drive detects *oC* or *oL1* and stops. Use this function to detect issues that occur in the application.

■ Parameter Setting

You can individually set the two overtorque/undertorque detection functions with the drive. Use the information in [Table 12.70](#) to set the parameters.

Table 12.70 Overtorque/Undertorque Detection Parameters

Configuration Parameter	Overtorque/Undertorque Detection 1	Overtorque/Undertorque Detection 2
MFDO Function Select	H2-01, H2-02, and H2-03 = B N.O.: Activated when detected	H2-01, H2-02, and H2-03 = 18 N.O.: Activated when detected
<ul style="list-style-type: none"> • Terminals M1-M2 • Terminals M3-M4 • Terminals M5-M6 	H2-01, H2-02, and H2-03 = 17 N.C.: Disactivated when detected	H2-01, H2-02, and H2-03 = 19 N.C.: Disactivated when detected
Detection conditions and selection of operation after detection	L6-01	L6-04
Detection Level	L6-02	L6-05
	Analog Input Terminal <i>*1</i> H3-xx = 7	-

Configuration Parameter	Overtorque/Undertorque Detection 1	Overtorque/Undertorque Detection 2
Detection Time	L6-03	L6-06

*1 You can also use an analog input terminal to supply the torque detection level. To enable this function, set $H3-xx = 7$ [MFAI Function Selection = Overtorque/Undertorque DetectLvl]. If both L6-02 and $H3-xx = 7$ are set, the analog input has priority and the setting of L6-02 is disabled.

You cannot use Overtorque/Undertorque Detection 2 to set the detection level for the analog input terminals.

Note:

In V/f Control, the drive uses the current level (100% of the drive rated output current) to detect overtorque/undertorque. In vector control, the drive uses the motor torque (100% of the motor rated torque) to detect overtorque/undertorque. When you enable the mechanical weakening detection function, the overtorque/undertorque detection level for all control modes is the current level (100% of the drive rated output current).

Time Chart for Detection of Overtorque/Undertorque

Overtorque Detection Time Chart

When you use Overtorque/Undertorque Detection 1, the drive detects overtorque if the motor current or motor torque is at the detection level set in L6-02 [Torque Detection Level 1] for the time set in L6-03 [Torque Detection Time 1]. Parameter L6-01 [Torque Detection Selection 1] sets the operation after detection.

When you use Overtorque/Undertorque Detection 2, set L6-04 [Torque Detection Selection 2], L6-05 [Torque Detection Level 2], and L6-06 [Torque Detection Time 2].

Use H2-01 to H2-03 [MFDO Function Select] to set the terminal that outputs the alarm.

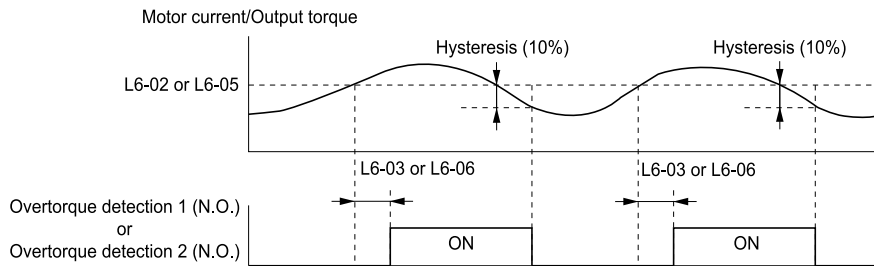

Figure 12.139 Overtorque Detection Time Chart

Note:

The drive applies a hysteresis of approximately 10% of the drive rated output current or the motor rated torque to the overtorque/undertorque detection function.

Undertorque Detection Time Chart

When you use Overtorque/Undertorque Detection 1, the drive detects undertorque if the motor current or motor torque is less than or equal to the detection level set in L6-02 for the time set in L6-03. Parameter L6-01 sets the operation after detection.

When you use Overtorque/Undertorque Detection 2, set the operation in L6-04, L6-05, and L6-06.

Use H2-01 to H2-03 [MFDO Function Select] to set the terminal that outputs the alarm.

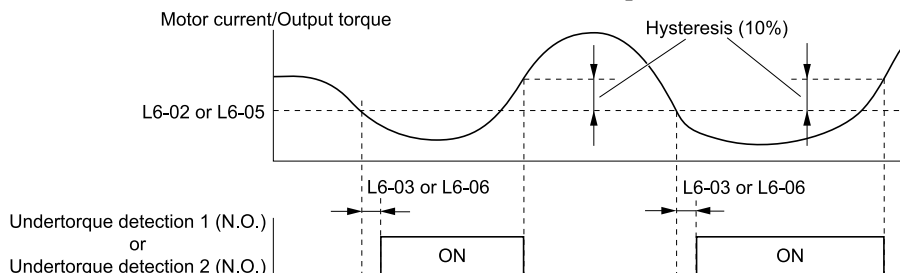

Figure 12.140 Undertorque Detection Time Chart

Note:

The drive applies a hysteresis of approximately 10% of the drive rated output current or the motor rated torque to the overtorque/undertorque detection function.

■ Mechanical Weakening Detection

The Mechanical Weakening Detection function detects the mechanical weakening of a machine that can cause overtorque or undertorque because of motor speed and total drive operation time.

The drive activates the function if the drive total operation time is longer than the time set in L6-11 [Mech Fatigue Hold Off Time]. You can use U4-01 [Cumulative Ope Time] to monitor the total operation time.

Parameter Settings

The drive detects Mechanical Weakening if overtorque or undertorque occur during the speed range set in L6-08 [Mechanical Fatigue Detect Select] and L6-09 [Mech Fatigue Detect Speed Level] for the length of time set in L6-10 [Mech Fatigue Detect Delay Time]. The drive uses L6-01 to L6-03 [Torque Detection 1 Setting Parameter] to detect oL5 [Mechanical Weakening Detection 1] or UL5 [Mechanical Weakening Detection 2]. Parameter L6-08 sets the operation after detection.

Set the terminal that outputs the fault in H2-01 to H2-03 [MFDO Function Select].

Table 12.71 Mechanical Weakening Detection Settings Parameters

Configuration Parameter		Mechanical Deterioration Detection
MFDO Function Select <ul style="list-style-type: none"> • Terminals M1-M2 • Terminals M3-M4 • Terminals M5-M6 		H2-01, H2-02, and H2-03 = 22
Operation Selection after Detection		L6-08
Detection Start Time		L6-11
Speed Range	Detection Criteria	L6-08
	Detection Level	L6-09
	Detection Time	L6-10
Overtorque	Detection Criteria	L6-01
	Detection Level	L6-02
	Detection Time	L6-03

■ L6-01: Torque Detection Selection 1

No. (Hex.)	Name	Description	Default (Range)
L6-01 (04A1)	Torque Detection Selection 1	<div style="display: flex; gap: 5px;"> V/f CL-V/f OLV CLV AOLV OLV/PM AOLV/PM CLV/PM EZOLV </div> Sets the speed range that detects overtorque and undertorque and the operation of drives (operation status) after detection.	0 (0 - 8)

The drive detects overtorque if the motor current or output torque is more than the level set in L6-02 [Torque Detection Level 1] for the length of time set in L6-03 [Torque Detection Time 1]. The drive detects undertorque if the motor current or output torque is less than the level set in L6-02 for the length the time set in L6-03.

0 : Disabled

The drive will not detect overtorque or undertorque.

1 : oL @ Speed Agree - Alarm only

The drive detects overtorque when the output frequency aligns with the frequency reference. Detection does not occur during acceleration/deceleration. The drive outputs an oL3 [Overtorque Detection 1] and operation continues.

2 : oL @ RUN - Alarm only

When the Run command is enabled, the drive constantly detects overtorque. The drive outputs an oL3 and operation continues.

3 : oL @ Speed Agree - Fault

The drive detects overtorque when the output frequency aligns with the frequency reference. Detection does not occur during acceleration/deceleration. The drive outputs an oL3 [Overtorque Detection 1] and operation stops.

4 : oL @ RUN - Fault

When the Run command is enabled, the drive constantly detects overtorque. The drive outputs an *oL3* and operation stops.

5 : UL @ Speed Agree - Alarm only

The drive detects undertorque when the output frequency aligns with the frequency reference. Detection does not occur during acceleration/deceleration. The drive outputs a *UL3* [*Undertorque Detection 1*] and operation continues.

6 : UL @ RUN - Alarm only

When the Run command is enabled, the drive constantly detects undertorque. The drive outputs a *UL3* and operation continues.

7 : UL @ Speed Agree - Fault

The drive detects undertorque when the output frequency aligns with the frequency reference. Detection does not occur during acceleration/deceleration. The drive outputs a *UL3* and operation stops.

8 : UL @ RUN - Fault

When the Run command is enabled, the drive constantly detects undertorque. The drive outputs a *UL3* and operation stops

■ L6-02: Torque Detection Level 1

No. (Hex.)	Name	Description	Default (Range)
L6-02 (04A2)	Torque Detection Level 1	<div style="display: flex; justify-content: space-between; align-items: center;"> V/f CL-V/f OLV CLV AOLV OLV/PM AOLV/PM CLV/PM EZOLV </div> <p>Sets the detection level for Overtorque/Undertorque Detection 1. In V/f control, drive rated output current = 100% value. In vector control, motor rated torque = 100% value.</p>	150% (0 - 300%)

Note:

- Set the torque detection level as a percentage of the drive rated output current in all control methods to set the mechanical weakening detection level.
- You can also use an analog input terminal to supply the torque detection level. To enable this function, set *H3-xx = 7* [*MFAI Function Select = Overtorque/Undertorque DetectLvl*]. If you set *L6-02* and *H3-x = 7*, the analog input is most important and the drive disables *L6-02*.

■ L6-03: Torque Detection Time 1

No. (Hex.)	Name	Description	Default (Range)
L6-03 (04A3)	Torque Detection Time 1	<div style="display: flex; justify-content: space-between; align-items: center;"> V/f CL-V/f OLV CLV AOLV OLV/PM AOLV/PM CLV/PM EZOLV </div> <p>Sets the detection time for Overtorque/Undertorque Detection 1.</p>	0.1 s (0.0 - 10.0 s)

■ L6-04: Torque Detection Selection 2

No. (Hex.)	Name	Description	Default (Range)
L6-04 (04A4)	Torque Detection Selection 2	<div style="display: flex; justify-content: space-between; align-items: center;"> V/f CL-V/f OLV CLV AOLV OLV/PM AOLV/PM CLV/PM EZOLV </div> <p>Sets the speed range that detects overtorque and undertorque and the operation of drives (operation status) after detection.</p>	0 (0 - 8)

The drive detects overtorque if the motor current or output torque is more than the level set in *L6-05* [*Torque Detection Level 2*] for the length of time set in *L6-06* [*Torque Detection Time 2*]. The drive detects undertorque if the motor current or output torque is less than the level set in *L6-05* for the length the time set in *L6-06*.

0 : Disabled

The drive will not detect overtorque or undertorque.

1 : oL @ Speed Agree - Alarm only

The drive detects overtorque when the output frequency aligns with the frequency reference. Detection does not occur during acceleration/deceleration. The drive outputs an *oL4* [*Overtorque Detection 2*] and operation continues.

2 : oL @ RUN - Alarm only

When the Run command is enabled, the drive constantly detects overtorque. The drive outputs an *oL4* and operation continues.

3 : oL @ Speed Agree - Fault

The drive detects overtorque when the output frequency aligns with the frequency reference. Detection does not occur during acceleration/deceleration. The drive outputs an *oL4* [*Overtorque Detection 2*] and operation stops.

4 : oL @ RUN - Fault

When the Run command is enabled, the drive constantly detects overtorque. The drive outputs an *oL4* and operation stops.

5 : UL @ Speed Agree - Alarm only

The drive detects undertorque when the output frequency aligns with the frequency reference. Detection does not occur during acceleration/deceleration. The drive outputs a *UL4* [*Undertorque Detection 2*] and operation continues.

6 : UL @ RUN - Alarm only

When the Run command is enabled, the drive constantly detects undertorque. The drive outputs a *UL4* and operation continues.

7 : UL @ Speed Agree - Fault

The drive detects undertorque when the output frequency aligns with the frequency reference. Detection does not occur during acceleration/deceleration. The drive outputs a *UL4* and operation stops.

8 : UL @ RUN - Fault

When the Run command is enabled, the drive constantly detects undertorque. The drive outputs a *UL4* and operation stops.

■ L6-05: Torque Detection Level 2

No. (Hex.)	Name	Description	Default (Range)
L6-05 (04A5)	Torque Detection Level 2	<div style="display: flex; justify-content: space-between; font-size: 0.8em; font-weight: bold;"> V/f CL-V/f OLV CLV AOLV OLV/PM AOLV/PM CLV/PM EZOLV </div> Sets the detection level for Overtorque/Undertorque Detection 2. In V/f control, drive rated output current = 100% value. In vector control, motor rated torque = 100% value.	150% (0 - 300%)

Note:

Overtorque/Undertorque Detection 2 cannot set the detection level for the analog input terminal.

■ L6-06: Torque Detection Time 2

No. (Hex.)	Name	Description	Default (Range)
L6-06 (04A6)	Torque Detection Time 2	<div style="display: flex; justify-content: space-between; font-size: 0.8em; font-weight: bold;"> V/f CL-V/f OLV CLV AOLV OLV/PM AOLV/PM CLV/PM EZOLV </div> Sets the detection time for Overtorque/Undertorque Detection 2.	0.1 s (0.0 - 10.0 s)

■ L6-07: Torque Detection Filter Time

No. (Hex.)	Name	Description	Default (Range)
L6-07 (04E5)	Torque Detection Filter Time	<div style="display: flex; justify-content: space-between; font-size: 0.8em; font-weight: bold;"> V/f CL-V/f OLV CLV AOLV OLV/PM AOLV/PM CLV/PM EZOLV </div> Sets the time constant for a primary filter to the torque reference or to the output current used to detect overtorque/undertorque.	0 ms (0 - 1000 ms)

■ L6-08: Mechanical Fatigue Detect Select

No. (Hex.)	Name	Description	Default (Range)
L6-08 (0468)	Mechanical Fatigue Detect Select	<div style="display: flex; justify-content: space-between; font-size: 0.8em; font-weight: bold;"> V/f CL-V/f OLV CLV AOLV OLV/PM AOLV/PM CLV/PM EZOLV </div> Sets the speed where the drive detects mechanical deterioration and how the drive operates (operation status) after detection.	0 (0 - 8)

The drive detects mechanical weakening through overtorque or undertorque as specified by the conditions set in *L6-08 to L6-11* [*Mechanical Deterioration Detection Settings Parameters*]. Set overtorque/undertorque detection conditions in *L6-01 to L6-03* [*Torque Detection 1 Settings Parameters*]. The drive disables the operation selection set in *L6-01* [*Torque Detection Selection 1*].

0 : Disabled

The drive does not detect mechanical weakening.

1 : oL5 @ Speed > L6-09 - Alarm

When the speed (signed) $\geq L6-09$ [Mech Fatigue Detect Speed Level], the drive detects mechanical weakening. The drive will detect oL5 [Mechanical Weakening Detection 1] and continue operation.

2 : oL5 @ ISpeedI > L6-09 - Alarm

When the speed (absolute value) $\geq L6-09$, the drive detects mechanical weakening. The drive will detect oL5 and continue operation.

3 : oL5 @ Speed > L6-09 - Fault

When the speed (signed) $\geq L6-09$, the drive detects mechanical weakening. The drive will detect oL5 and stop operation.

4 : oL5 @ ISpeedI > L6-09 - Fault

When the speed (absolute value) $\geq L6-09$, the drive detects mechanical weakening. The drive will detect oL5 and stop operation.

5 : UL5 @ Speed < L6-09 - Alarm

When the speed (signed) $\leq L6-09$, the drive detects mechanical weakening. The drive will detect UL5 [Mechanical Weakening Detection 2] and continue operation.

6 : UL5 @ ISpeedI < L6-09 - Alarm

When the speed (absolute value) $\leq L6-09$, the drive detects mechanical weakening. The drive will detect UL5 and continue operation.

7 : UL5 @ Speed < L6-09 - Fault

When the speed (signed) $\leq L6-09$, the drive detects mechanical weakening. The drive will detect UL5 and stop operation.

8 : UL5 @ ISpeedI < L6-09 - Fault

When the speed (absolute value) $\leq L6-09$, the drive detects mechanical weakening. The drive will detect UL5 and stop operation.

■ L6-09: Mech Fatigue Detect Speed Level

No. (Hex.)	Name	Description	Default (Range)
L6-09 (0469)	Mech Fatigue Detect Speed Level	 Sets the speed level where the drive will operate the mechanical deterioration detection function, as a percentage of the Maximum Output Frequency.	110.0% (-110.0 - 110.0%)

Parameters L6-01 to L6-03 [Torque Detection 1 Settings Parameters] set the overtorque/undertorque detection conditions.

When L6-08 = 2, 4, 6, 8 [Mechanical Fatigue Detect Select = Speed : unsigned], the setting value of L6-09 is the absolute value. When L6-09 is set to a negative number, the drive processes this value as a positive number.

■ L6-10: Mech Fatigue Detect Delay Time

No. (Hex.)	Name	Description	Default (Range)
L6-10 (046A)	Mech Fatigue Detect Delay Time	 Sets the time for mechanical deterioration detection.	0.1 s (0.0 - 10.0 s)

When the detection conditions set in L6-08 [Mechanical Weakening Detect Ope] continue for the time set in L6-10, the drive will detect mechanical weakening.

■ L6-11: Mech Fatigue Hold Off Time

No. (Hex.)	Name	Description	Default (Range)
L6-11 (046B)	Mech Fatigue Hold Off Time	 Sets the time that the drive will start mechanical deterioration detection triggered by the cumulative operation time of the drive.	0 h (0 - 65535 h)

When the total operation time of the drive is more than the value set in *L6-11*, the drive will detect mechanical weakening. Use *U4-01 [Cumulative Ope Time]* to monitor the drive total operation time.

◆ L7: Torque Limit

The torque limit function limits the internal torque reference for the drive to limit the quantity of torque generated by the motor to a constant quantity. This function keeps the torque applied to loads and regenerative torque less than a set quantity. This function also prevents damage to machinery and increases the reliability of continuous operation. You can set torque limits individually for the four quadrants, which include torque direction (motoring/regeneration) and direction of motor rotation (forward/reverse). When the torque reference value is at the set torque limit, the MFDO terminal set for *During Torque Limit [H2-xx = 30]* activates.

Note:

- The drive output current limits maximum output torque. The drive limits torque to 150% of the rated output current for Heavy Duty Rating (HD) and to 110% of the rated output current for Normal Duty Rating (ND). The actual output torque is not more than the limits of the drive rated output current when you set the torque limit to a high value.
- When you use torque limits for lifting applications, do not lower the torque limit value too much. When the torque limit function is triggered, falls and rollbacks can occur because of sudden acceleration stops and stalls of the motor.

■ Configuring Settings

Use one of these methods to set torque limits:

- Individually set the four torque limit quadrants using *L7-01 to L7-04 [Torque Limit]*.
- Use MFAI to individually set the four torque limit quadrants. Set *H3-02, H3-06, H3-10 = 10, 11, 12 [MFAI Function Select = Forward/Reverse/Regenerative Torque Limit]*.
- Use MFAI to set all four torque limit quadrants together. Set *H3-02, H3-06, H3-10 = 15 [General Torque Limit]*.
- Use a communication option to set all four torque limit quadrants together.

Figure 12.141 shows the configuration method for each quadrant.

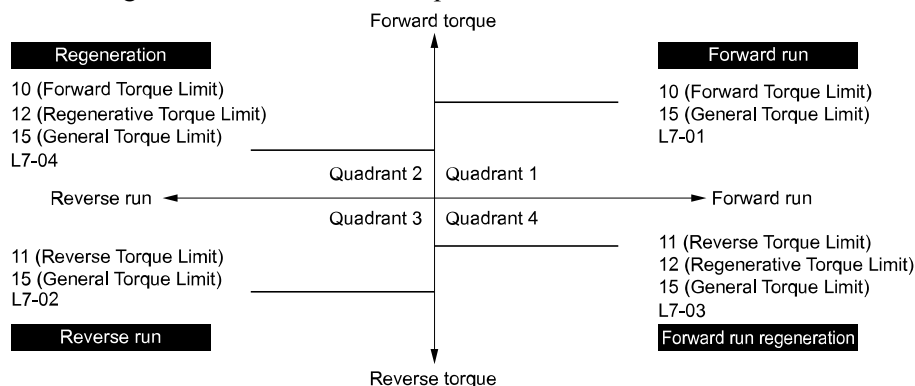

Figure 12.141 Torque Limits and Analog Input Setting Parameters

Note:

- When *L7-01 to L7-04* and analog inputs or communication option torque limits set torque limits for the same quadrant, the drive enables the lower value. In this example of parameter settings, the torque limit for quadrant 1 is 130% and the torque limit for quadrants 2, 3, and 4 is 150%. Settings: *L7-01 = 130%, L7-02 to L7-04 = 200%*, and MFAI torque limit = 150%
- The drive output current limits maximum output torque. The torque limit is 150% of the rated output current for HD and to 120% of the rated output current for ND. The actual output torque is not more than the limits of the drive rated output current when you set the torque limit to a high value.

■ L7-01: Forward Torque Limit

No. (Hex.)	Name	Description	Default (Range)
L7-01 (04A7) RUN	Forward Torque Limit	V/f CL-V/f OLV CLV AOLV OLV/PM AOLV/PM CLV/PM EZOLV Sets the torque limit value for forward motoring as a percentage, where motor rated torque is the 100% value.	200% (0 - 300%)

Parameter Details

Note:

- When you use this method to set the torque limit, it enables the lower torque limit:
–Set H3-02, H3-06, or H3-10 = 10, 15 [MFAI Function Select = Forward, Reverse/Regenerative Torque Limit].
–Use a communication option to set the torque limits
- You must think about drive capacity when a large quantity of torque is necessary. If you set the value too high, the drive can detect *oC* [Overcurrent].
- If you set the value too low with large loads, the motor can stall.

■ L7-02: Reverse Torque Limit

No. (Hex.)	Name	Description	Default (Range)
L7-02 (04A8) RUN	Reverse Torque Limit	<div style="display: flex; justify-content: space-between; font-size: 0.8em;"> V/f CL-V/f OLV CLV AOLV OLV/PM AOLV/PM CLV/PM EZOLV </div> <p>Sets the torque limit value for reversed motoring as a percentage, where motor rated torque is the 100% value.</p>	200% (0 - 300%)

Note:

- When you use this method to set the torque limit, it enables the lower torque limit:
–Set H3-02, H3-06, or H3-10 = 10, 15 [MFAI Function Select = Forward, Reverse/Regenerative Torque Limit].
–Use a communication option to set the torque limits
- You must think about drive capacity when a large quantity of torque is necessary. If you set the value too high, the drive can detect *oC* [Overcurrent].
- If you set the value too low with large loads, the motor can stall.

■ L7-03: Forward Regenerative Trq Limit

No. (Hex.)	Name	Description	Default (Range)
L7-03 (04A9) RUN	Forward Regenerative Trq Limit	<div style="display: flex; justify-content: space-between; font-size: 0.8em;"> V/f CL-V/f OLV CLV AOLV OLV/PM AOLV/PM CLV/PM EZOLV </div> <p>Sets the torque limit value for forward regenerative conditions as a percentage of the motor rated torque.</p>	200% (0 - 300%)

Note:

- When you use this method to set the torque limit, it enables the lower torque limit:
–Set H3-02, H3-06, or H3-10 = 10, 15 [MFAI Function Select = Forward, Reverse/Regenerative Torque Limit].
–Use a communication option to set the torque limits
- You must think about drive capacity when a large quantity of torque is necessary. If you set the value too high, the drive can detect *oC* [Overcurrent].
- If you set the value too low with large loads, the motor can stall.

■ L7-04: Reverse Regenerative Trq Limit

No. (Hex.)	Name	Description	Default (Range)
L7-04 (04AA) RUN	Reverse Regenerative Trq Limit	<div style="display: flex; justify-content: space-between; font-size: 0.8em;"> V/f CL-V/f OLV CLV AOLV OLV/PM AOLV/PM CLV/PM EZOLV </div> <p>Sets the torque limit value for reversed regenerative conditions as a percentage of the motor rated torque.</p>	200% (0 - 300%)

Note:

- When you use this method to set the torque limit, it enables the lower torque limit:
–Set H3-02, H3-06, or H3-10 = 10, 15 [MFAI Function Select = Forward, Reverse/Regenerative Torque Limit].
–Use a communication option to set the torque limits
- You must think about drive capacity when a large quantity of torque is necessary. If you set the value too high, the drive can detect *oC* [Overcurrent].
- If you set the value too low with large loads, the motor can stall.

■ L7-06: Torque Limit Integral Time

No. (Hex.)	Name	Description	Default (Range)
L7-06 (04AC)	Torque Limit Integral Time	<div style="display: flex; justify-content: space-between; font-size: 0.8em;"> V/f CL-V/f OLV CLV AOLV OLV/PM AOLV/PM CLV/PM EZOLV </div> <p>Sets the integral time constant for the torque limit function.</p>	200 ms (5 - 10000 ms)

Decrease the setting value to increase torque limit responsiveness when you use torque limits and $L7-07 = 1$ [*Torque Limit during Accel/Decel = Proportional & Integral control*].

If there is hunting when torque limits are active, increase the setting value.

■ L7-07: Torque Limit during Accel/Decel

No. (Hex.)	Name	Description	Default (Range)
L7-07 (04C9)	Torque Limit during Accel/Decel	<div style="display: flex; justify-content: space-between; font-size: 0.8em;"> V/f CL-V/f OLV CLV AOLV OLV/PM AOLV/PM CLV/PM EZOLV </div> Sets the torque limit function during acceleration and deceleration.	0 (0, 1)

0 : Proportional only

The torque limit function works with proportional control during acceleration and deceleration, and switches to integral control at constant speed. Use this setting when quickly reaching the target speed is more important than the torque limit during speed changes.

1 : Proportional & Integral control

The torque limit function always uses integral control. Use this setting when a very accurate torque limit is necessary during speed changes, for example in winding machine applications.

If you make the torque limit the most important, it can:

- Increase the acceleration and deceleration times.
- Not let the motor speed reach the frequency reference value during run at constant speed.

■ L7-16: Torque Limit Process at Start

No. (Hex.)	Name	Description	Default (Range)
L7-16 (044D)	Torque Limit Process at Start	<div style="display: flex; justify-content: space-between; font-size: 0.8em;"> V/f CL-V/f OLV CLV AOLV OLV/PM AOLV/PM CLV/PM EZOLV </div> Assigns a time filter to allow the torque limit to build at start.	1 (0, 1)

0 : Disabled

There is torque limit at start without a delay time.

Use this setting to maximize the response time when sudden acceleration or deceleration at start is necessary.

1 : Enabled

There is a delay time of 64 ms at start to build the torque limit.

■ L7-35: Low Freq Regen Torque Limit Lvl

No. (Hex.)	Name	Description	Default (Range)
L7-35 (1B57) Expert	Low Freq Regen Torque Limit Lvl	<div style="display: flex; justify-content: space-between; font-size: 0.8em;"> V/f CL-V/f OLV CLV AOLV OLV/PM AOLV/PM CLV/PM EZOLV </div> Sets the torque limit used during low-speed regeneration. Usually it is not necessary to change this setting.	50.0% (0.0 - 200.0%)

Reduces the regenerative torque limit to the level set with $L7-35$ when using low frequencies such that the output frequency is less than $L7-36$ [*Regen Torque Limit Derate Freq*]. The drive does not decrease torque limits during ramp to stop operation. Decrease the setting of $L7-35$ when oC [*Overcurrent*] issues occur while a regenerative load is input and the speed reference is constant.

Note:

- Reduce the setting value of $L7-35$ in increments of 10.0% and reduce the setting value of $L7-36$ in increments of 2.0 Hz when faults occur during regenerative loads at low speed.
- Setting values that are too high can cause faults.
- The torque limit reduction function does not operate when $L7-35$ is set with a value larger than $L7-03$ [*Forward Regenerative Trq Limit*] or $L7-04$ [*Reverse Regenerative Trq Limit*].
- The motor may rotate slightly faster than the reference when a regenerative load is input at low speeds while $L7-35$ is set to a low value.

■ L7-36: Regen Torque Limit Derate Freq

No. (Hex.)	Name	Description	Default (Range)
L7-36 (1B58) Expert	Regen Torque Limit Derate Freq	<div style="display: flex; justify-content: space-between; font-size: 0.8em;"> V/f CL-V/f OLV CLV AOLV OLV/PM AOLV/PM CLV/PM EZOLV </div> Sets the frequency width at which L7-35 [Low Freq Regen Torque Limit Lvl] operates.	6.0 Hz (0.0 - 30.0 Hz)

If the drive detects *oC* [Overcurrent] faults when you connect regenerative loads at low speed, increase the setting value. Decreases the torque limit as specified by the setting of L7-35 in a range of $0 \leq$ output frequency $<$ L7-36. When the torque limit gradually changes as specified by the output frequency until the output frequency = L7-36, the value changes to the setting of L7-03 [Forward Regenerative Trq Limit] and L7-04 [Reverse Regenerative Trq Limit].

Note:

If you increase the setting of L7-36, the motor will rotate at a speed higher than specified when a you input a regenerative load. Do not set the value higher than necessary.

◆ L8: Drive Protection

L8 parameters set protective functions that prevent faults such as overheating, phase loss, and ground faults.

■ L8-01: 3% ERF DB Resistor Protection

No. (Hex.)	Name	Description	Default (Range)
L8-01 (04AD)	3% ERF DB Resistor Protection	<div style="display: flex; justify-content: space-between; font-size: 0.8em;"> V/f CL-V/f OLV CLV AOLV OLV/PM AOLV/PM CLV/PM EZOLV </div> Sets the function to enable braking resistor protection with a Yaskawa ERF series braking resistor (3% ED) installed on the heatsink.	0 (0, 1)

0 : Disabled

Disables braking resistor protection. Use this setting for dynamic braking options that are not Yaskawa ERF series braking resistors.

1 : Enabled

Enables protection for Yaskawa ERF series braking resistors.

Note:

Set L8-01 = 1 and H2-01 to H2-03 = D [MFDO Function Select = Braking Resistor Fault]. Use a sequence to turn OFF power with MFDO.

■ L8-02: Overheat Alarm Level

No. (Hex.)	Name	Description	Default (Range)
L8-02 (04AE)	Overheat Alarm Level	<div style="display: flex; justify-content: space-between; font-size: 0.8em;"> V/f CL-V/f OLV CLV AOLV OLV/PM AOLV/PM CLV/PM EZOLV </div> Sets the <i>oH</i> detection level in temperature.	Determined by o2-04, C6-01 (50 - 150 °C)

If the heatsink temperature is more than the temperature set in this parameter, the drive detects an overheat pre-alarm. To enable this function, set one of H2-01 to H2-03 [MFDO Function Select] to 20 [Drive Overheat Pre-Alarm (oH)].

If the temperature increases to the overheat fault level, the drive will trigger an *oHI* [Heatsink Overheat] fault and stop operation.

■ L8-03: Overheat Pre-Alarm Selection

No. (Hex.)	Name	Description	Default (Range)
L8-03 (04AF)	Overheat Pre-Alarm Selection	<div style="display: flex; justify-content: space-between; font-size: 0.8em;"> V/f CL-V/f OLV CLV AOLV OLV/PM AOLV/PM CLV/PM EZOLV </div> Sets the operation of drives when an <i>oH</i> alarm is detected.	3 (0 - 4)

0 : Ramp to Stop

The drive ramps the motor to stop in the deceleration time. Fault relay output terminal MA-MC turns ON, and MB-MC turns OFF.

1 : Coast to Stop

The output turns off and the motor coasts to stop. Fault relay output terminal MA-MC turns ON, and MB-MC turns OFF.

2 : Fast Stop (Use C1-09)

The drive stops the motor in the deceleration time set in *C1-09* [Fast Stop Time]. Fault relay output terminal MA-MC turns ON, and MB-MC turns OFF.

3 : Alarm Only

The keypad shows *oH* and the drive continues operation. The output terminal set for *Alarm* [H2-01 to H2-03 = 10] activates.

4 : Operate at Reduced Speed (L8-19)

The drive decelerates to the level set in *L8-19* [Freq Reduction @ *oH* Pre-Alarm] and continues operation. *oH* flashes on the keypad.

oH flashes on the keypad. When the alarm is output, the drive decelerates each 10 seconds. If the drive decelerates 10 times and the alarm continues to be output, the output terminal set for *oH* Pre-Alarm Reduction Limit [H2-01 to H2-03 = 4D] activates. When the alarm is not output during deceleration, the drive accelerates until it is at the frequency reference that was applicable before the alarm was turned off. Figure 12.142 shows the output of the alarm and the drive operation at a decreased output frequency.

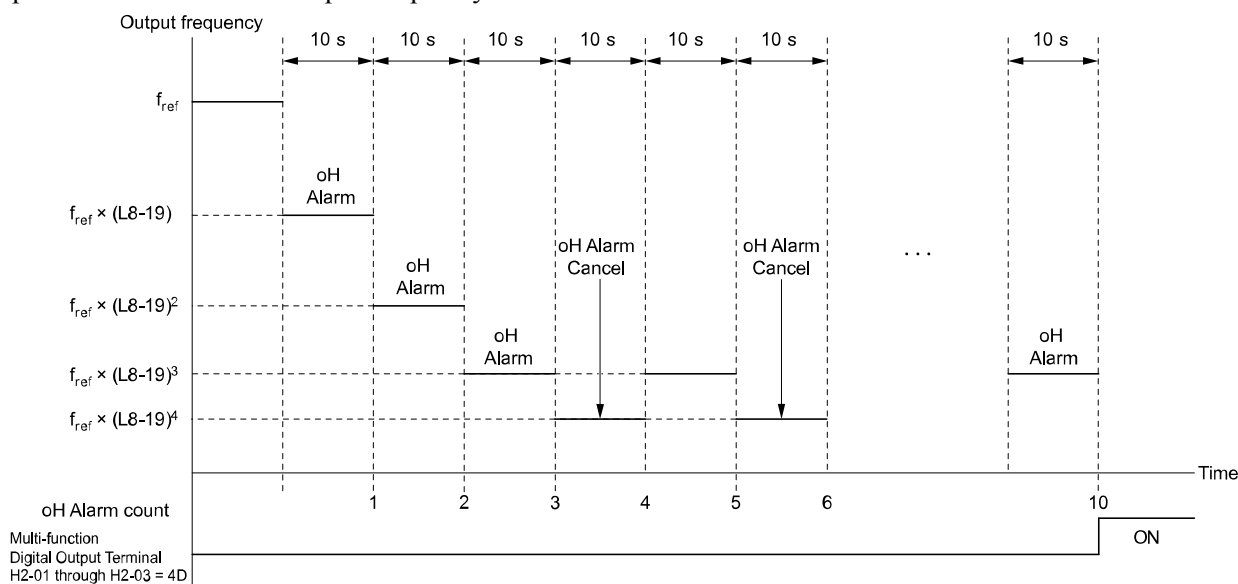

Figure 12.142 Drive Operation at a Decreased Output Frequency when the Overheat Alarm is Output

■ L8-05: Input Phase Loss Protection Sel

No. (Hex.)	Name	Description	Default (Range)
L8-05 (04B1)	Input Phase Loss Protection Sel	<input type="checkbox"/> V/f <input type="checkbox"/> CL-V/f <input type="checkbox"/> OLV <input type="checkbox"/> CLV <input type="checkbox"/> AOLV <input type="checkbox"/> OLV/PM <input type="checkbox"/> AOLV/PM <input type="checkbox"/> CLV/PM <input type="checkbox"/> EZOLV Sets the function to enable and disable input phase loss detection.	1 (0, 1)

0 : Disabled

1 : Enabled

The drive measures ripples in DC bus voltage to detect input phase loss.

The drive detects phase loss when power supply phase loss occurs or the main circuit capacitor becomes unusable, which causes *PF* [Input Phase Loss] to show on the keypad.

Disable the detection of the input power supply phase loss function in these conditions:

- During deceleration
- The run command is not input
- The output current is less than 30% of the drive rated current.

■ L8-07: Output Phase Loss Protection Sel

No. (Hex.)	Name	Description	Default (Range)
L8-07 (04B3)	Output Phase Loss Protection Sel	<div style="display: flex; justify-content: space-between; align-items: center;"> <input type="checkbox"/> V/f <input type="checkbox"/> CL-V/f <input type="checkbox"/> OLV <input type="checkbox"/> CLV <input type="checkbox"/> AOLV <input type="checkbox"/> OLVP/PM <input type="checkbox"/> AOLV/PM <input type="checkbox"/> CLV/PM <input type="checkbox"/> EZOLV </div> <p>Sets the function to enable and disable output phase loss detection. The drive starts output phase loss detection when the output current decreases to less than 5% of the drive rated current.</p>	1 (0 - 2)

Note:

The drive can incorrectly start output phase loss detection in these conditions:

- The motor rated current is very small compared to the drive rating.
- The drive is operating a PM motor with a small load.

0 : Disabled

1 : Fault when one phase is lost

If the drive loses one output phase, it will trigger *LF [Output Phase Loss]*.

The output turns off and the motor coasts to stop.

2 : Fault when two phases are lost

If the drive loses more than one output phase, it will trigger *LF [Output Phase Loss]*.

The output turns off and the motor coasts to stop.

■ L8-09: Output Ground Fault Detection

No. (Hex.)	Name	Description	Default (Range)
L8-09 (04B5)	Output Ground Fault Detection	<div style="display: flex; justify-content: space-between; align-items: center;"> <input type="checkbox"/> V/f <input type="checkbox"/> CL-V/f <input type="checkbox"/> OLV <input type="checkbox"/> CLV <input type="checkbox"/> AOLV <input type="checkbox"/> OLVP/PM <input type="checkbox"/> AOLV/PM <input type="checkbox"/> CLV/PM <input type="checkbox"/> EZOLV </div> <p>Sets the function to enable and disable ground fault protection.</p>	Determined by o2-04 (0, 1)

0 : Disabled

The drive will not detect ground faults.

1 : Enabled

If there is high leakage current or a ground short circuit in one or two output phases, the drive will detect *GF [Ground Fault]*.

Note:

If the ground path impedance is low, *oC [Overcurrent]*, *SC [Out Short Circuit or IGBT Fault]*, or *ov [DC Bus Overvoltage]* can stop the motor.

■ L8-10: Heatsink Fan Operation Selection

No. (Hex.)	Name	Description	Default (Range)
L8-10 (04B6)	Heatsink Fan Operation Selection	<div style="display: flex; justify-content: space-between; align-items: center;"> <input type="checkbox"/> V/f <input type="checkbox"/> CL-V/f <input type="checkbox"/> OLV <input type="checkbox"/> CLV <input type="checkbox"/> AOLV <input type="checkbox"/> OLVP/PM <input type="checkbox"/> AOLV/PM <input type="checkbox"/> CLV/PM <input type="checkbox"/> EZOLV </div> <p>Sets operation of the heatsink cooling fan.</p>	0 (0 - 2)

0 : During Run, w/ L8-11 Off-Delay

The drive turns on the fan when a Run command is active.

1 : Always On

The fan turns on when you supply power to the drive. When you release the Run command and the delay time set in *L8-11 [HeatsinkCoolingFan Off DelayTime]* is expired, the fan stops. his setting extends the fan lifetime.

2 : On when Drive Temp Reaches L8-64

The fan turns on when the drive detects that the main circuit is overheating.

■ L8-11: Heatsink Fan Off-Delay Time

No. (Hex.)	Name	Description	Default (Range)
L8-11 (04B7)	Heatsink Fan Off-Delay Time	<p>V/f CL-V/f OLV CLV AOLV OLV/PM AOLV/PM CLV/PM EZOLV</p> <p>Sets the length of time that the drive will wait before it stops the cooling fan after it cancels the Run command when L8-10 = 0 [Heatsink Cooling Fan Ope Select = Dur Run (OffDly)].</p>	60 s (0 - 300 s)

■ L8-12: Ambient Temperature Setting

No. (Hex.)	Name	Description	Default (Range)
L8-12 (04B8)	Ambient Temperature Setting	<p>V/f CL-V/f OLV CLV AOLV OLV/PM AOLV/PM CLV/PM EZOLV</p> <p>Sets the ambient temperature of the drive installation area.</p>	40 °C (-10 °C - +50 °C)

The drive automatically adjusts the drive rated current to the best value as specified by the set temperature. Set the ambient temperature of the area where you install the drive to a value that is more than the drive rating.

Refer to [Derating Depending on Ambient Temperature on page 450](#) for information about derating depending on ambient temperature.

■ L8-15: Drive oL2 @ Low Speed Protection

No. (Hex.)	Name	Description	Default (Range)
L8-15 (04BB)	Drive oL2 @ Low Speed Protection	<p>V/f CL-V/f OLV CLV AOLV OLV/PM AOLV/PM CLV/PM EZOLV</p> <p>Sets the function to decrease drive overload at low speeds to prevent damage to the main circuit transistor during low speed operation (at 6 Hz or slower) to prevent oL2 [Drive Overloaded].</p>	1 (0, 1)

Note:

Contact Yaskawa or your nearest sales representative for consultation before disabling this function at low speeds. Frequent operation of drives under conditions of high output current in low speed ranges may shorten the service life of the drive IGBT due to heat stress.

0 : Disabled (No Additional Derate)

The drive does not decrease the overload protection level.

1 : Enabled (Reduced oL2 Level)

When the drive detects oL2 during low speed operation, it automatically decreases the overload detection level.

At zero speed, the drive derates the overload by 50%.

■ L8-18: Software Current Limit Selection

No. (Hex.)	Name	Description	Default (Range)
L8-18 (04BE)	Software Current Limit Selection	<p>V/f CL-V/f OLV CLV AOLV OLV/PM AOLV/PM CLV/PM EZOLV</p> <p>Set the software current limit selection function to prevent damage to the main circuit transistor caused by too much current.</p>	0 (0, 1)

0 : Disabled

When the output current is at the software current limit value, the drive does not restrict the output voltage.

Note:

The drive may detect an oC [Overcurrent] when loads are particularly heavy or the acceleration time is particularly short.

1 : Enabled

When the output current is at the software current limit value, the drive decreases output voltage to decrease output current.

When the output current decreases to the software current limit level, the drive starts usual operation.

■ **L8-19: Freq Reduction @ oH Pre-Alarm**

No. (Hex.)	Name	Description	Default (Range)
L8-19 (04BF)	Freq Reduction @ oH Pre-Alarm	<div style="display: flex; justify-content: space-between; align-items: center;"> V/f CL-V/f OLV CLV AOLV OLV/PM AOLV/PM CLV/PM EZOLV </div> Sets the ratio at which the drive derates the frequency reference during an <i>oH</i> alarm.	0.8 (0.1 - 0.9)

When these two conditions are correct, this function is enabled:

- $L8-03 = 4$ [Overheat Pre-Alarm Ope Selection = Run@L8-19 Rate]
- *oH* alarm is output

■ **L8-20: Control Fault & Step Out Detect**

No. (Hex.)	Name	Description	Default (Range)
L8-20 (04C0) Expert	Control Fault & Step Out Detect	<div style="display: flex; justify-content: space-between; align-items: center;"> V/f CL-V/f OLV CLV AOLV OLV/PM AOLV/PM CLV/PM EZOLV </div> Sets operation after the drive detects a <i>CF</i> fault when $A1-02 = 4$ [Control Method Selection = Advanced Open Loop Vector].	1 (0 - 2)

If you enter a Stop command but it cannot stop drive operation, the drive will detect *CF*.

0 : Disabled

1 : CF/STPo Detection Enabled

2 : CF ALM/Stop

The drive stops DC injection braking as specified by the value of $b2-03$ [DC Inject Braking Time at Start].

Note:

- When $A1-02 = 4$, control will not be stable if you do not do Rotational Auto-Tuning. This can cause *CF* faults if you ramp to stop. If the drive detects *CF*, do Rotational Auto-Tuning and Line-to-Line Resistance Tuning. Also, do Line-to-Line Resistance Tuning.
- If you set $A1-02 = 4$ and set these parameters, the drive can detect *CF* because it cannot stop the operation in some load conditions. Make sure that you do Rotational Auto-Tuning and Line-to-Line Resistance Tuning correctly and then set $L8-20 = 0$.
 - $d5-01 = 1$ [Torque Control Selection = Torque Control]
 - $L3-11 = 1$ [Overvoltage Suppression Select = Enabled]
 - Decreased $L7-01$ to $L7-04$ [Torque Limit].

■ **L8-27: Overcurrent Detection Gain**

No. (Hex.)	Name	Description	Default (Range)
L8-27 (04DD)	Overcurrent Detection Gain	<div style="display: flex; justify-content: space-between; align-items: center;"> V/f CL-V/f OLV CLV AOLV OLV/PM AOLV/PM CLV/PM EZOLV </div> Sets the PM motor overcurrent detection level as a percentage of the motor rated current value.	300.0% (0.0 - 1000.0%)

Note:

- The overcurrent detection function detects the lower of these two values:
 - Drive overcurrent level
 - Motor rated current $\times L8-27 / 100$
- Set $L7-xx$ [Torque Limit] parameters $< L8-27$.
- When you set $L8-27 = 0.0$, it disables this function. In usual conditions, do not set $L8-27 = 0.0$. If the drive rated current is much higher than the motor rated current, PM motor magnets can demagnetize if current flows at the drive overcurrent detection level.

■ **L8-29: Output Unbalance Detection Sel**

No. (Hex.)	Name	Description	Default (Range)
L8-29 (04DF)	Output Unbalance Detection Sel	<div style="display: flex; justify-content: space-between; align-items: center;"> V/f CL-V/f OLV CLV AOLV OLV/PM AOLV/PM CLV/PM EZOLV </div> Sets the function to detect <i>LF2</i> .	1 (0, 1)

This function prevents damage to PM motors. Current unbalance can heat a PM motor and demagnetize the magnets. When the current is unbalanced, the drive will detect *LF2* to stop the motor and prevent damage to the motor.

0 : Disabled

1 : Enabled

■ L8-31: LF2 Detection Time

No. (Hex.)	Name	Description	Default (Range)
L8-31 (04E1)	LF2 Detection Time	V/f CL-V/f OLV CLV AOLV OLV/PM AOLV/PM CLV/PM EZOLV Sets the LF2 [Output Current Imbalance] detection time.	3 (1 – 100)

When the output current is unbalanced for longer than the time set in *L8-31*, the drive detects *LF2*.

Note:

- Set *L8-29* = 1 [Output Unbalance Detection Sel = Enabled] to enable *L8-31*.
- If the drive incorrectly detects *LF2*, increase *L8-31* in 5-unit increments.
- The keypad shows *L8-31* when *E9-01* = 1 [Motor Type Selection = Permanent Magnet (PM)] in EZ Vector Control.

■ L8-35: Installation Method Selection

No. (Hex.)	Name	Description	Default (Range)
L8-35 (04EC)	Installation Method Selection	V/f CL-V/f OLV CLV AOLV OLV/PM AOLV/PM CLV/PM EZOLV Sets the type of drive installation.	Determined by the drive (0 - 3)

Note:

- Parameter *A1-03* [Initialize Parameters] does not initialize this parameter.
- This parameter is set to the correct value when the drive is shipped. Side-by-Side installation
–Change the value only in these conditions:
–When you install a UL Type 1 kit on an IP20/UL Open Type drive to convert the drive to an IP20/UL Type 1 drive.

The overload protection detection level for the drive is automatically adjusted to the optimal value in accordance with the setting value. Refer to *Derating Depending on Ambient Temperature on page 450* for information on derating depending on ambient temperature.

0 : IP20/OpenChassis Enc/Ex Heatsink

Use this setting to install an IP20/UL Open Type drive or when the heatsink (cooling fin) is outside of the enclosure panel.

Make sure that there is 30 mm (1.18 in) minimum of space between drives or between the drive and side of the enclosure panel.

1 : Side-by-Side Mounting

Use this setting to install more than one drive Side-by-Side.

Make sure that there is 2 mm (0.08 in) minimum of space between drives.

2 : IP20/NEMA Type 1/IP55

Use this setting to install IP20/UL Type 1 drives or IP55/UL Type 12 Heatsink External Mounting drives.

3 : Finless

Use this setting to install a finless drive (no heatsink).

■ L8-38: Carrier Frequency Reduction

No. (Hex.)	Name	Description	Default (Range)
L8-38 (04EF)	Carrier Frequency Reduction	V/f CL-V/f OLV CLV AOLV OLV/PM AOLV/PM CLV/PM EZOLV Sets the carrier frequency reduction function. The drive reduces the carrier frequency when the output current is more than a specified level.	Determined by A1-02, C6-01 and o2-04 (0 - 2)

If you decrease the carrier frequency, it increases the overload tolerance. The overload capacity increases temporarily for *oL2* [Drive Overloaded] and lets the drive operate through transient load peaks and not trip.

0 : Disabled

The drive will not decrease the carrier frequency at high current.

1 : Enabled below 6 Hz

The drive decreases the carrier frequency at speeds less than 6 Hz when the current is more than 100% of the drive rated current.

When the current is less than 88% or the output frequency is more than 7 Hz, the drive goes back to the usual carrier frequency.

2 : Enabled for All Speeds

The drive decreases the carrier frequency at these speeds:

- Output current is a minimum of 100% of the drive rated current and the frequency reference is less than 6 Hz.
- Output current is a minimum of 109% of the drive rated current, the drive is in Normal Duty mode, and the frequency reference is 7 Hz or more.
- Output current is a minimum of 112% of the drive rated current, the drive is in Heavy Duty mode, and the frequency reference is 7 Hz or more.

When the drive switches the carrier frequency to the set value, it uses the delay time set in *L8-40 [CarrierFreqReduct OffDelayTime]* and a hysteresis of 12%.

■ **L8-40: Carrier Freq Reduction Off-Delay**

No. (Hex.)	Name	Description	Default (Range)
L8-40 (04F1)	Carrier Freq Reduction Off-Delay	<input type="checkbox"/> V/f <input type="checkbox"/> CL-V/f <input type="checkbox"/> OLV <input type="checkbox"/> CLV <input type="checkbox"/> AOLV <input type="checkbox"/> OLV/PM <input type="checkbox"/> AOLV/PM <input type="checkbox"/> CLV/PM <input type="checkbox"/> EZOLV Sets the length of time until the automatically reduced carrier frequency returns to the condition before the reduction.	Determined by A1-02 (0.00 - 2.00 s)

Set *L8-40* $\neq 0.00$ to enable the carrier frequency reduction function during start-up. When operation starts, the drive automatically decreases the carrier frequency. When the time set in *L8-40* is expired, the carrier frequency returns to the value set in *C6-02 [Carrier Frequency Selection]*.

■ **L8-41: High Current Alarm Selection**

No. (Hex.)	Name	Description	Default (Range)
L8-41 (04F2)	High Current Alarm Selection	<input type="checkbox"/> V/f <input type="checkbox"/> CL-V/f <input type="checkbox"/> OLV <input type="checkbox"/> CLV <input type="checkbox"/> AOLV <input type="checkbox"/> OLV/PM <input type="checkbox"/> AOLV/PM <input type="checkbox"/> CLV/PM <input type="checkbox"/> EZOLV Sets the function to cause an <i>HCA [Current Alarm]</i> when the output current is more than 150% of the drive rated current.	0 (0, 1)

0 : Disabled

The drive will not detect *HCA [Current Alarm]*.

1 : Enabled

If the output current is more than 150% of the drive rated current, the drive will detect *HCA*.

The MFDO terminal set for an alarm [*H2-01 to H2-03 = 10*] activates.

■ **L8-51: STPo I Detection Level**

No. (Hex.)	Name	Description	Default (Range)
L8-51 (0471) Expert	STPo I Detection Level	<input type="checkbox"/> V/f <input type="checkbox"/> CL-V/f <input type="checkbox"/> OLV <input type="checkbox"/> CLV <input type="checkbox"/> AOLV <input type="checkbox"/> OLV/PM <input type="checkbox"/> AOLV/PM <input type="checkbox"/> CLV/PM <input type="checkbox"/> EZOLV Sets the <i>STPo [Motor Step-Out Detected]</i> detection level as a percentage of the motor rated current.	0.0% (0.0 - 300.0%)

Note:

The detection level is automatically calculated when *L8-51 = 0*.

■ **L8-52: STPo Integration Level**

No. (Hex.)	Name	Description	Default (Range)
L8-52 (0472) Expert	STPo Integration Level	<input type="checkbox"/> V/f <input type="checkbox"/> CL-V/f <input type="checkbox"/> OLV <input type="checkbox"/> CLV <input type="checkbox"/> AOLV <input type="checkbox"/> OLV/PM <input type="checkbox"/> AOLV/PM <input type="checkbox"/> CLV/PM <input type="checkbox"/> EZOLV Sets the detection level for <i>STPo [Motor Step-Out Detected]</i> related to the ACR integral value.	1.0 (0.1 - 2.0)

■ L8-53: STPo Integration Time

No. (Hex.)	Name	Description	Default (Range)
L8-53 (0473) Expert	STPo Integration Time	V/f CL-V/f OLV CLV AOLV OLV/PM AOLV/PM CLV/PM EZOLV Sets the length of time until the drive detects <i>STPo</i> after it is more than the value of <i>L8-51 [STPo I Detection Level]</i> .	1.0 s (1.0 - 10.0 s)

■ L8-54: STPo Id Diff Detection

No. (Hex.)	Name	Description	Default (Range)
L8-54 (0474) Expert	STPo Id Diff Detection	V/f CL-V/f OLV CLV AOLV OLV/PM AOLV/PM CLV/PM EZOLV Sets the Id deviation detection function for <i>STPo</i> [<i>Motor Step-Out Detected</i>].	1 (0, 1)

0 : Disabled

1 : Enabled

■ L8-55: Internal DB TransistorProtection

No. (Hex.)	Name	Description	Default (Range)
L8-55 (045F)	Internal DB TransistorProtection	V/f CL-V/f OLV CLV AOLV OLV/PM AOLV/PM CLV/PM EZOLV Sets the protection function for the internal braking transistor.	1 (0, 1)

0 : Disable

Disables braking transistor protection.

Use this setting, if enabling the braking transistor can cause an *rF [Braking Resistor Fault]* in these conditions:

- With a regenerative converter, for example D1000.
- With a regenerative unit, for example R1000.
- When connecting braking resistor options to the drive, for example CDBR units.
- Without an internal braking transistor.

1 : Protection Enabled

Prevents damage to the internal braking transistor when using a braking transistor or optional braking resistors.

These models have a built-in braking transistor:

- 2004 to 2138
- 4002 to 4168

■ L8-56: Stall P @ Accel Activation Time

No. (Hex.)	Name	Description	Default (Range)
L8-56 (047D) Expert	Stall P @ Accel Activation Time	V/f CL-V/f OLV CLV AOLV OLV/PM AOLV/PM CLV/PM EZOLV Sets the length time that the acceleration stall prevention function can continue to operate before the drive detects an <i>STPo</i> [<i>Motor Step-Out Detected</i>].	5000 ms (100 - 5000 ms)

Note:

If this value is too small, it can cause incorrect detection of *STPo*. If this value is too large, the drive will not detect *STPo*.

■ L8-57: Stall Prevention Retry Counts

No. (Hex.)	Name	Description	Default (Range)
L8-57 (047E) Expert	Stall Prevention Retry Counts	V/f CL-V/f OLV CLV AOLV OLV/PM AOLV/PM CLV/PM EZOLV Sets the number of times the acceleration stall prevention function can operate until speeds agree before the drive detects an <i>STPo</i> [<i>Motor Step-Out Detected</i>].	10 (1 - 10 times)

Note:

If this value is too small, it can cause incorrect detection of *STPo*. If this value is too large, the drive will not detect *STPo*.

■ **L8-90: STPo Detection Level (Low Speed)**

No. (Hex.)	Name	Description	Default (Range)
L8-90 (0175) Expert	STPo Detection Level (Low Speed)	<div style="display: flex; justify-content: space-between; font-size: small;"> V/f CL-V/f OLV CLV AOLV OLV/PM AOLV/PM CLV/PM EZOLV </div> <p>Sets the detection level that the control fault must be equal to or more than to cause an <i>STPo</i> [Motor Step-Out Detected].</p>	Determined by A1-02 (0 - 5000 times)

This function detects when PM motors are not synchronized.

The drive cannot detect when motors are not synchronized because the frequency reference is low during start up and the motor is locked. If fault detection is necessary in these conditions, set the control fault detection level to enable detection of desynchronization because of motor locking. Increase the setting in 5-unit increments.

■ **L8-93: Low Speed Pull-out DetectionTime**

No. (Hex.)	Name	Description	Default (Range)
L8-93 (073C) Expert	Low Speed Pull-out DetectionTime	<div style="display: flex; justify-content: space-between; font-size: small;"> V/f CL-V/f OLV CLV AOLV OLV/PM AOLV/PM CLV/PM EZOLV </div> <p>Sets the length of time the drive will wait to start baseblock after detecting <i>LSo</i> [Low Speed Motor Step-Out].</p>	1.0 s (0.0 - 10.0 s)

Set this parameter to 0.0 to disable the function.

■ **L8-94: Low Speed Pull-out Detect Level**

No. (Hex.)	Name	Description	Default (Range)
L8-94 (073D) Expert	Low Speed Pull-out Detect Level	<div style="display: flex; justify-content: space-between; font-size: small;"> V/f CL-V/f OLV CLV AOLV OLV/PM AOLV/PM CLV/PM EZOLV </div> <p>Sets the detection level for <i>LSo</i> [Low Speed Motor Step-Out] as a percentage of <i>E1-04</i> [Maximum Output Frequency].</p>	3% (0 - 10%)

■ **L8-95: Low Speed Pull-out Amount**

No. (Hex.)	Name	Description	Default (Range)
L8-95 (077F) Expert	Low Speed Pull-out Amount	<div style="display: flex; justify-content: space-between; font-size: small;"> V/f CL-V/f OLV CLV AOLV OLV/PM AOLV/PM CLV/PM EZOLV </div> <p>Sets the average count of <i>LSo</i> [Low Speed Motor Step-Out] detections.</p>	10 (1 - 50 times)

◆ **L9: Drive Protection 2**

L9 parameters are used to configure the protection function used to detect cooling fan faults.

■ **L9-16: FAn1 Detect Time**

No. (Hex.)	Name	Description	Default (Range)
L9-16 (11DC) Expert	FAn1 Detect Time	<div style="display: flex; justify-content: space-between; font-size: small;"> V/f CL-V/f OLV CLV AOLV OLV/PM AOLV/PM CLV/PM EZOLV </div> <p>Sets the detection time for <i>FAn1</i> [Drive Cooling Fan Fault]. Yaskawa recommends that you do not change this parameter value.</p>	4.0 s (0.0 - 30.0 s)

12.10 n: Special Adjustment

n parameters set these functions:

- Function to prevent hunting
- High-slip braking
- Motor line-to-line resistance online tuning
- Fine-tune the parameters that adjust motor control

◆ n1: Hunting Prevention

The Hunting Prevention function will not let low inertia or operation with a light load cause hunting. Hunting frequently occurs when you have a high carrier frequency and an output frequency less than 30 Hz.

■ n1-01: Hunting Prevention Selection

No. (Hex.)	Name	Description	Default (Range)
n1-01 (0580)	Hunting Prevention Selection	<div style="display: flex; gap: 5px;"> V/f CL-V/f OLV CLV AOLV OLV/PM AOLV/PM CLV/PM EZOLV </div> Sets the function to prevent hunting.	Determined by o2-04 (0 to 2)

When drive response is more important than the decrease of motor vibration, disable this function.

If hunting occurs, or if you use a high carrier frequency or SwingPWM, set this parameter to 2 for better hunting prevention.

0 : Disabled

1 : Enabled (Normal)

2 : Enabled (High Carrier Frequency)

■ n1-02: Hunting Prevention Gain Setting

No. (Hex.)	Name	Description	Default (Range)
n1-02 (0581) Expert	Hunting Prevention Gain Setting	<div style="display: flex; gap: 5px;"> V/f CL-V/f OLV CLV AOLV OLV/PM AOLV/PM CLV/PM EZOLV </div> Sets the performance of the hunting prevention function. Usually it is not necessary to change this parameter.	1.00 (0.00 - 2.50)

Adjust this parameter in these conditions:

- When $n1-01 = 1, 2$ [Hunting Prevention Selection = Enabled (Normal), Enabled (High Carrier Frequency)]: If oscillation occurs when you operate a motor with a light load, increase the setting value in 0.1-unit increments.
- When $n1-01 = 1, 2$, if the motor stalls: Decrease the setting value in 0.1-unit increments.

■ n1-03: Hunting Prevention Time Constant

No. (Hex.)	Name	Description	Default (Range)
n1-03 (0582) Expert	Hunting Prevention Time Constant	<div style="display: flex; gap: 5px;"> V/f CL-V/f OLV CLV AOLV OLV/PM AOLV/PM CLV/PM EZOLV </div> Sets the primary delay time constant of the hunting prevention function. Usually it is not necessary to change this parameter.	Determined by o2-04 (0 - 500 ms)

Adjust this parameter in these conditions:

- Load inertia is large: Increase the setting value. If the setting value is too high, response will be slower. Also, there will be oscillation when the frequency is low.
- Oscillation occurs at low frequencies: Decrease the setting value.

■ **n1-05: Hunting Prevent Gain in Reverse**

No. (Hex.)	Name	Description	Default (Range)
n1-05 (0530) Expert	Hunting Prevent Gain in Reverse	<div style="display: flex; gap: 5px;"> V/f CL-V/f OLV CLV AOLV OLV/PM AOLV/PM CLV/PM EZOLV </div> <p>Sets the performance of the hunting prevention function. This parameter adjusts Reverse run. Usually it is not necessary to change this parameter.</p>	0.00 (0.00 - 2.50)

Note:

When you set this parameter to 0, the value set in *n1-02 [Hunting Prevention Gain Setting]* is effective when the motor rotates in reverse.

Adjust this parameter in these conditions:

- When *n1-01 = 1, 2 [Hunting Prevention Selection = Enabled (Normal), Enabled (High Carrier Frequency)]*: If oscillation occurs when you operate a motor with a light load, increase the setting value in 0.1-unit increments.
- When *n1-01 = 1, 2*, if the motor stalls: Decrease the setting value in 0.1-unit increments.

■ **n1-08: Current Detection Method**

No. (Hex.)	Name	Description	Default (Range)
n1-08 (1105) Expert	Current Detection Method	<div style="display: flex; gap: 5px;"> V/f CL-V/f OLV CLV AOLV OLV/PM AOLV/PM CLV/PM EZOLV </div> <p>Sets how the drive decreases the motor vibration that is caused by leakage current. Usually it is not necessary to change this parameter.</p>	0 (0, 1)

0 : 2-Phases

1 : 3-Phases

Note:

Set this parameter to 1 to suppress motor vibrations caused by leakage current when the wiring distance is long.

■ **n1-13: DC Bus Stabilization Control**

No. (Hex.)	Name	Description	Default (Range)
n1-13 (1B59) Expert	DC Bus Stabilization Control	<div style="display: flex; gap: 5px;"> V/f CL-V/f OLV CLV AOLV OLV/PM AOLV/PM CLV/PM EZOLV </div> <p>Sets the oscillation suppression function for the DC bus voltage.</p>	0 (0, 1)

0 : Disabled

1 : Enabled

Note:

If the DC bus voltage does not become stable with light loads and the drive detects *ov [Overvoltage]*, set this parameter to 1.

■ **n1-14: DC Bus Stabilization Time**

No. (Hex.)	Name	Description	Default (Range)
n1-14 (1B5A) Expert	DC Bus Stabilization Time	<div style="display: flex; gap: 5px;"> V/f CL-V/f OLV CLV AOLV OLV/PM AOLV/PM CLV/PM EZOLV </div> <p>Adjusts the responsiveness of the oscillation suppression function for the DC bus voltage. Set <i>n1-13 = 1 [DC Bus Stabilization Control = Enabled]</i> to enable this parameter.</p>	100.0 ms (50.0 - 500.0 ms)

Note:

Adjust this parameter in 100 ms increments.

■ **n1-15: PWM Voltage Offset Calibration**

No. (Hex.)	Name	Description	Default (Range)
n1-15 (0BF8) Expert	PWM Voltage Offset Calibration	<div style="display: flex; gap: 5px;"> V/f CL-V/f OLV CLV AOLV OLV/PM AOLV/PM CLV/PM EZOLV </div> <p>Sets the calibration method that the drive uses to decrease torque/current ripple.</p>	Determined by A1-02 (0 - 2)

This calibration function lets the drive suppress the torque ripple of a motor. Usually it is not necessary to change this setting.

0 : No Calibration

1 : One Time Calibrate at Next Start

2 : Calibrate Every Time at Start

■ n1-16: Hunting Prevention High Fc Gain

No. (Hex.)	Name	Description	Default (Range)
n1-16 (0BFB) Expert	Hunting Prevention High Fc Gain	V/f CL-V/f OLV CLV AOLV OLV/PM AOLV/PM CLV/PM EZOLV Sets the gain for the hunting prevention function. This parameter functions best with a high carrier frequency. Usually it is not necessary to change this parameter.	Determined by o2-04 (0.00 - 2.50)

Set $n1-01 = 2$ [*Hunting Prevention Selection = Enabled (High Carrier Frequency)*] to enable this function.

If the motor oscillates, set $n1-01 = 2$. If that does not have an effect, increase this parameter in 0.2-unit increments.

■ n1-17: Hunting Prevent High Fc Filter

No. (Hex.)	Name	Description	Default (Range)
n1-17 (0BFC) Expert	Hunting Prevent High Fc Filter	V/f CL-V/f OLV CLV AOLV OLV/PM AOLV/PM CLV/PM EZOLV Sets the responsiveness of the hunting prevention function. Usually it is not necessary to change this parameter.	500 ms (0 - 1000 ms)

When $n1-01 = 2$ [*Hunting Prevention Selection = Enabled (High Carrier Frequency)*], if the motor stalls when the load changes, increase the value set in this parameter in 100 ms increments.

If you set $n1-01 = 2$ and you cannot suppress hunting, increase the value set in this parameter in 100 ms increments.

■ n1-20: Voltage Calibration Duration

No. (Hex.)	Name	Description	Default (Range)
n1-20 (1588) Expert	Voltage Calibration Duration	V/f CL-V/f OLV CLV AOLV OLV/PM AOLV/PM CLV/PM EZOLV Sets the calibration time at start. Usually it is not necessary to change this parameter.	50 ms (10 - 500 ms)

◆ n2: Auto Freq Regulator (AFR)

The speed feedback detection reduction function (or AFR: Automatic Frequency Regulator) helps the speed become stable when you suddenly apply or remove a load.

Note:

Before you change $n2-xx$ parameters, do one of these procedures:

- Set the motor parameters and V/f pattern correctly.
- Do Rotational Auto-Tuning.

■ n2-01: Automatic Freq Regulator Gain

No. (Hex.)	Name	Description	Default (Range)
n2-01 (0584)	Automatic Freq Regulator Gain	V/f CL-V/f OLV CLV AOLV OLV/PM AOLV/PM CLV/PM EZOLV Sets the gain of the AFR function as a magnification value. Usually it is not necessary to change this setting.	1.00 (0.00 - 10.00)

Adjust this parameter in these conditions:

- If hunting or oscillation occurs with light loads, increase the setting value in 0.05-unit increments and examine the response.
- When torque is not sufficient with heavy loads or to make the torque or speed response better, decrease the setting value in 0.05-unit increments and examine the response.

■ n2-02: Automatic Freq Regulator Time 1

No. (Hex.)	Name	Description	Default (Range)
n2-02 (0585)	Automatic Freq Regulator Time 1	<div style="display: flex; justify-content: space-between; font-size: small;"> V/f CL-V/f OLV CLV AOLV OLV/PM AOLV/PM CLV/PM EZOLV </div> <p>Sets the time constant that sets the rate of change for the AFR function. Usually it is not necessary to change this setting.</p>	50 ms (0 - 2000 ms)

Adjust this parameter in these conditions:

- If there is hunting or oscillation with a light load, increase the setting value in 50 ms increments and examine the response. If the load inertia is large, increase the setting value in 50 ms increments and examine the response.
- If torque is not sufficient with a heavy load or if you must increase torque or speed responsiveness, decrease the setting value in 10 ms increments and examine the response.

Note:

- Set $n2-02 \leq n2-03$ [Automatic Freq Regulator Time 2]. If $n2-02 > n2-03$, the drive will detect *oPE08* [Parameter Selection Error].
- When you change the value in *n2-02*, also change the value in *C4-02* [Torque Compensation Delay Time] by the same ratio.

■ n2-03: Automatic Freq Regulator Time 2

No. (Hex.)	Name	Description	Default (Range)
n2-03 (0586)	Automatic Freq Regulator Time 2	<div style="display: flex; justify-content: space-between; font-size: small;"> V/f CL-V/f OLV CLV AOLV OLV/PM AOLV/PM CLV/PM EZOLV </div> <p>Sets the time constant that sets the speed difference of the AFR function. Use this parameter for speed searches or regeneration. Usually it is not necessary to change this setting.</p>	750 ms (0 - 2000 ms)

Adjust this parameter in these conditions:

- If the drive detects *ov* [Overvoltage] when acceleration stops under high-inertia loads, increase the setting value in 50 ms increments.
If the drive detects *ov* when the load changes suddenly, increase the setting value in 50 ms increments.
- To increase the responsiveness of torque and speed, decrease the setting value in 10 ms increments and examine the response.

Note:

- Set $n2-02 \leq n2-03$ [Automatic Freq Regulator Time 2]. If $n2-02 > n2-03$, the drive will detect *oPE08* [Parameter Selection Error].
- When you change the value in *n2-03*, also change the value in *C4-06* [Motor 2 Torque Comp Delay Time] by the same ratio.

◆ n3: High Slip Braking (HSB) and Overexcitation Braking

n3 parameters configure High Slip Braking and Overexcitation Deceleration.

■ High Slip Braking

High slip braking quickly decelerates motors without braking resistors.

This lets you stop a motor more quickly than with the ramp to stop processes. This function is best for applications that do not frequently stop the motor, for example the fast stop function for high-inertia loads. Braking starts when the MFDI for *High Slip Braking (HSB) Activate* [*H1-xx = 68*] activates.

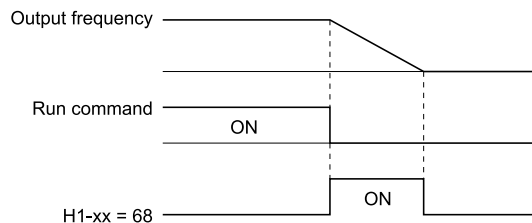

Figure 12.143 High Slip Braking Time Chart

An induction motor is necessary to use high slip braking. Set *A1-02* [Control Method Selection] to one of these values to enable high slip braking:

- 0 [V/f Control]
- 1 [V/f Control with Encoder]

Principles of Operation

HSB increases motor slip by significantly decreasing the frequency supplied to the motor at the same time that deceleration starts. A large quantity of current flows through the motor to increase the motor loss, and the motor decelerates while the motor windings consume the regenerative energy.

The drive keeps the motor current at a constant level during deceleration to prevent overvoltage and do automatic braking and it also keeps a slip level that causes the maximum quantity of deceleration torque.

High Slip Braking Precautions

- Do not use the high slip braking function in these applications:
 - Frequent deceleration
 - Deceleration time differences
 - Continuous regenerative loads
 - It is necessary to accelerate again during deceleration
- Motor loss increases during high slip braking. Use this function when the duty time factor is 5% ED or less and the braking time is 90 seconds or less. The load inertia and motor characteristics have an effect on the braking time.
- The drive ignores the configured deceleration time during high slip braking. To stop motors in the configured deceleration time, set $L3-04 = 4$ [*Stall Prevention during Decel = Overexcitation/High Flux*].
- You cannot use high slip braking to decelerate deceleration at user-defined speeds. To decelerate at user-defined speeds, use the overexcitation deceleration function.
- You cannot accelerate the motor again during high slip braking until you fully stop the motor and input the Run command again.
- You cannot use high slip braking and the KEB Ride-Thru function at the same time. If you enable those two functions, the drive will detect $oPE03$ [*Multi-Function Input Setting Err*].

■ Overexcitation Deceleration

Overexcitation deceleration quickly decelerates motors without braking resistors. This lets you stop a motor more quickly than with the ramp to stop processes.

Overexcitation deceleration increases excitation current during deceleration to cause a large quantity of braking torque through motor overexcitation. You can set the deceleration speed to adjust the deceleration time for overexcitation deceleration.

Overexcitation deceleration lets you accelerate the motor again during deceleration.

Enter the Run command during overexcitation deceleration to cancel overexcitation deceleration and accelerate the drive to the specified speed.

To enable this function, set $L3-04 = 4, 5$ [*Stall Prevention during Decel = Overexcitation/High Flux, Overexcitation/High Flux 2*].

When $L3-04 = 4$, the motor will decelerate for the deceleration time set in $C1-02$, $C1-04$, $C1-06$, or $C1-08$. If the drive detects ov [*Overvoltage*], increase the deceleration time.

When $L3-04 = 5$, the drive uses the value in $C1-02$, $C1-04$, $C1-06$, or $C1-08$ to decelerate and it adjusts the deceleration rate to keep the DC bus voltage at the level set in $L3-17$ [*DC Bus Regulation Level*]. The load inertia and motor characteristics have an effect on the braking time.

Notes on Overexcitation Deceleration

- Do not use Overexcitation Deceleration with a braking resistor.
- Do not use Overexcitation Deceleration for these applications. Connect a braking resistor to the drive as an alternative to Overexcitation Deceleration.
 - Frequent sudden decelerations
 - Continuous regenerative loads
 - Low inertia machines
 - Machines that have no tolerance for torque ripples
- Motor loss increases during overexcitation deceleration. Use this function when the duty time factor is 5% ED or less and the braking time is 90 seconds or less. The load inertia and motor characteristics have an effect on the

braking time. You can use overexcitation deceleration in OLV control and CLV control, but those control methods decrease the precision of torque control and braking efficiency. Use V/f control for the best results.

- The drive disables these functions during braking with Overexcitation Deceleration 2:
 - Hunting Prevention Function (V/f Control)
 - Torque Limit Speed Control (OLV Control)

■ n3-01: HSB Deceleration Frequency Width

No. (Hex.)	Name	Description	Default (Range)
n3-01 (0588) Expert	HSB Deceleration Frequency Width	<div style="display: flex; justify-content: space-between; align-items: center;"> V/f CL-V/f OLV CLV AOLV OLV/PM AOLV/PM CLV/PM EZOLV </div> <p>Sets the amount by which the output frequency is to be lowered during high-slip braking, as a percentage of E1-04 [Maximum Output Frequency], which represents the 100% value.</p>	5% (1 - 20%)

When you must detect *ov* [DC Bus Overvoltage] during high-slip braking, set this parameter to a large value.

■ n3-02: HSB Current Limit Level

No. (Hex.)	Name	Description	Default (Range)
n3-02 (0589) Expert	HSB Current Limit Level	<div style="display: flex; justify-content: space-between; align-items: center;"> V/f CL-V/f OLV CLV AOLV OLV/PM AOLV/PM CLV/PM EZOLV </div> <p>Sets the maximum current output during high-slip braking as a percentage of E2-01 [Motor Rated Current (FLA)]. Also set the current suppression to prevent exceeding drive overload tolerance.</p>	Determined by C6-01, L8-38 (0 - 150%)

Note:

The upper limit of the setting range changes when the setting for C6-01 [Normal / Heavy Duty Selection] changes.

- 150% when C6-01 = 0 [Heavy Duty Rating (HD) for Constant Torque Applications].
- 110% when C6-01 = 1 [Normal Duty Rating (ND) for Variable Torque Applications].

When you decrease the setting value for current suppression, it will make the deceleration time longer.

- When you must detect *ov* [DC Bus Overvoltage] during high-slip braking, set this parameter to a low value.
- If the motor current increases during high-slip braking, decrease the setting value to prevent burn damage in the motor.
- The overload tolerance for the drive is 150% for Heavy Duty Rating (HD) and 110% for Normal Duty Rating (ND).

■ n3-03: HSB Dwell Time at Stop

No. (Hex.)	Name	Description	Default (Range)
n3-03 (058A) Expert	HSB Dwell Time at Stop	<div style="display: flex; justify-content: space-between; align-items: center;"> V/f CL-V/f OLV CLV AOLV OLV/PM AOLV/PM CLV/PM EZOLV </div> <p>Sets the dwell time, a length of time when high-slip braking is ending and during which the motor speed decreases and runs at a stable speed. For a set length of time, the drive will hold the actual output frequency at the minimum output frequency set in E1-09.</p>	1.0 s (0.0 - 10.0 s)

If there is too much inertia or when the motor is coasting to a stop after high-slip braking is complete, increase the setting value. If the setting value is too low, machine inertia can cause the motor to rotate after high-slip braking is complete.

■ n3-04: HSB Overload Time

No. (Hex.)	Name	Description	Default (Range)
n3-04 (058B) Expert	HSB Overload Time	<div style="display: flex; justify-content: space-between; align-items: center;"> V/f CL-V/f OLV CLV AOLV OLV/PM AOLV/PM CLV/PM EZOLV </div> <p>Sets the time used to detect <i>oL7</i> [High Slip Braking Overload], which occurs when the output frequency does not change during high-slip braking. Usually it is not necessary to change this parameter.</p>	40 s (30 - 1200 s)

If a force on the load side is rotating the motor or if there is too much load inertia connected to the motor, the drive will detect *oL7*.

The current flowing to the motor from the load can overheat the motor and cause burn damage to the motor. Set this parameter to prevent burn damage to the motor.

■ n3-13: OverexcitationBraking (OEB) Gain

No. (Hex.)	Name	Description	Default (Range)
n3-13 (0531)	OverexcitationBraking (OEB) Gain	<div style="display: flex; justify-content: space-between; font-size: 0.8em; font-weight: bold;"> V/f CL-V/f OLV CLV AOLV OLV/PM AOLV/PM CLV/PM EZOLV </div> <p>Sets the gain value that the drive multiplies by the V/f pattern output value during overexcitation deceleration to calculate the overexcitation level.</p>	1.10 (1.00 - 1.40)

The V/f pattern output value goes back to its usual level after the motor stops or accelerates again to the frequency reference speed.

The best value of this parameter changes when the flux saturation characteristics of the motor change.

- Gradually increase the value of *n3-13* to 1.25 or 1.30 to increase the braking power of Overexcitation Deceleration. If the gain is too much, the motor can have flux saturation and cause a large quantity of current to flow. This can increase the deceleration time.
- Decrease the setting value if flux saturation causes overcurrent. If you increase the setting value, the drive can detect *oC* [Overcurrent], *oL1* [Motor Overload], and *oL2* [Drive Overload]. Decrease the value of *n3-21* [HSB Current Suppression Level] to prevent *oC* and *oL*.
- Regular use of overexcitation deceleration or extended periods of overexcitation deceleration can increase internal motor temperatures. Decrease the setting value in these conditions.
- If *ov* [Overvoltage] occurs, increase the deceleration time.

■ n3-14: OEB High Frequency Injection

No. (Hex.)	Name	Description	Default (Range)
n3-14 (0532) Expert	OEB High Frequency Injection	<div style="display: flex; justify-content: space-between; font-size: 0.8em; font-weight: bold;"> V/f CL-V/f OLV CLV AOLV OLV/PM AOLV/PM CLV/PM EZOLV </div> <p>Sets the function that injects harmonic signals during overexcitation deceleration.</p>	0 (0, 1)

Enable this parameter to set a shorter deceleration time.

Note:

- If you frequently use overexcitation deceleration on a motor, the motor loss will increase the risk of burn damage.
- When you set this parameter to 1, the motor can make a loud excitation sound during overexcitation deceleration. If the excitation sound is unwanted, set this parameter to 0 to disable the function.

0 : Disabled

1 : Enabled

The drive injects harmonic signals at the time of overexcitation deceleration. You can decrease the deceleration time because motor loss increases.

■ n3-21: HSB Current Suppression Level

No. (Hex.)	Name	Description	Default (Range)
n3-21 (0579)	HSB Current Suppression Level	<div style="display: flex; justify-content: space-between; font-size: 0.8em; font-weight: bold;"> V/f CL-V/f OLV CLV AOLV OLV/PM AOLV/PM CLV/PM EZOLV </div> <p>Sets the upper limit of the current that is suppressed at the time of overexcitation deceleration as a percentage of the drive rated current.</p>	100% (0 - 150%)

If flux saturation during Overexcitation Deceleration makes the motor current become more than the value set in this parameter, the drive will automatically decrease the overexcitation gain. If *oC* [Overcurrent], *oL1* [Motor Overload], or *oL2* [Drive Overloaded] occur during overexcitation deceleration, decrease the setting value.

If repetitive or long overexcitation deceleration cause the motor to overheat, decrease the setting value.

■ n3-23: Overexcitation Braking Operation

No. (Hex.)	Name	Description	Default (Range)
n3-23 (057B)	Overexcitation Braking Operation	<div style="display: flex; justify-content: space-between; font-size: 0.8em; font-weight: bold;"> V/f CL-V/f OLV CLV AOLV OLV/PM AOLV/PM CLV/PM EZOLV </div> <p>Sets the direction of motor rotation where the drive will enable overexcitation.</p>	0 (0 - 2)

0 : Disabled

1 : Enabled Only when Rotating FWD

2 : Enabled Only when Rotating REV

Note:

When $n3-23 = 1, 2$, the drive enables overexcitation only in the direction of motor rotation in which a regenerative load is applied. Increased motor loss can decrease *ov* [Overvoltage] faults.

◆ n4: Adv Open Loop Vector Tune

The following explains how to make special adjustments for *Advanced Open Loop Vector* [A1-02 = 4].

- First, perform Rotational Auto-Tuning.
- Operation that fluctuates around zero speed cannot be carried out when there is a load. For applications of this sort, set A1-02 = 3 [Open Loop Vector].
- The tolerance of regenerative torque at low speeds is diminished. If regenerative torque is required in the low speed range, set A1-02 = 3.
- This cannot be used for elevators or similar applications. There is a risk that the load could slip.

■ n4-60: Motoring Low Speed Comp Gain

No. (Hex.)	Name	Description	Default (Range)
n4-60 (1B80)	Motoring Low Speed Comp Gain	V/f CL-V/f OLV CLV AOLV OLV/PM AOLV/PM CLV/PM EZOLV Sets a compensation gain to improve the control qualities for motoring loads in the low speed range.	100.0% (50.0 - 200.0%)

Note:

- To increase the torque precision in the motoring direction when you operate at low speeds, do Stationary Auto-Tuning for Line-to-Line Resistance only, or increase the value of this parameter in 5% increments.
- If the output frequency changes when you operate at low speeds, do Stationary Auto-Tuning for Line-to-Line Resistance only. If it is not better, increase this parameter in 10% increments. The recommended setting is 50% to 100%.

■ n4-61: Low Speed Comp Frequency Level

No. (Hex.)	Name	Description	Default (Range)
n4-61 (1B81)	Low Speed Comp Frequency Level	V/f CL-V/f OLV CLV AOLV OLV/PM AOLV/PM CLV/PM EZOLV Sets a frequency at which the settings n4-60 [Motoring Low Speed Comp Gain] and n4-62 [Regen Low Speed Comp Gain] are enabled. When the output frequency < n4-61, the drive adjusts the torque to agree with the settings for n4-60 and n4-62. Usually it is not necessary to change this setting.	6.00 Hz (0.50 - 12.00 Hz)

■ n4-62: Regen Low Speed Comp Gain

No. (Hex.)	Name	Description	Default (Range)
n4-62 (1B82)	Regen Low Speed Comp Gain	V/f CL-V/f OLV CLV AOLV OLV/PM AOLV/PM CLV/PM EZOLV Sets a compensation gain to improve the control qualities for regenerative loads in the low speed range.	100.0 (50.0 - 500.0)

Note:

If you do not apply a regenerative load when you operate at low speeds, do stationary Auto-Tuning for Line-to-Line Resistance only. If this does not make it better, increase the setting value in 5% increments. The recommended setting is 100% to 150%. If you set this parameter too high, the drive will detect CF [Control Fault] at stop.

■ n4-63: Speed EstimateResponse@High Freq

No. (Hex.)	Name	Description	Default (Range)
n4-63 (1B83)	Speed EstimateResponse@High Freq	V/f CL-V/f OLV CLV AOLV OLV/PM AOLV/PM CLV/PM EZOLV Sets the responsiveness of the speed estimation in high speed ranges, where the output frequency is $\geq n4-67$ [Estimate Gain Switchover Freq].	60.0 (0.1 - 300.0)

If better response of speed estimation is necessary, or if the motor oscillates, or if there is a large quantity of torque ripple, increase the setting value in 10.0 unit increments. If this does not make it better, decrease the setting value in 10.0 unit increments.

Note:

Do rotational Auto-Tuning before you adjust *n4-63*, *n4-64* [*Speed Estimate Response@Low Freq*], *n4-65* [*Flux Estimate Response@High Freq*], and *n4-66* [*Flux Estimate Response @Low Freq*].

■ n4-64: Speed Estimate Response@Low Freq

No. (Hex.)	Name	Description	Default (Range)
n4-64 (1B84)	Speed Estimate Response@Low Freq	<div style="display: flex; justify-content: space-between; font-size: small;"> V/f CL-V/f OLV CLV AOLV OLV/PM AOLV/PM CLV/PM EZOLV </div> <p>Sets the responsiveness of the speed estimation in low speed ranges, where $0 \leq$ the output frequency, which is $< n4-67$ [<i>Estimate Gain Switchover Freq</i>].</p>	60.0 (0.1 - 300.0)

If better response of speed estimation is necessary, or if the motor oscillates, or if there is a large quantity of torque ripple, increase the setting value in 10.0 unit increments.

Note:

Do rotational Auto-Tuning before you adjust *n4-63* [*Speed EstimateResponse@High Freq*], *n4-64*, *n4-65* [*Flux Estimate Response@High Freq*], and *n4-66* [*Flux Estimate Response @Low Freq*].

■ n4-65: Flux Estimate Response@High Freq

No. (Hex.)	Name	Description	Default (Range)
n4-65 (1B85)	Flux Estimate Response@High Freq	<div style="display: flex; justify-content: space-between; font-size: small;"> V/f CL-V/f OLV CLV AOLV OLV/PM AOLV/PM CLV/PM EZOLV </div> <p>Sets the responsiveness of the magnetic flux estimation in high speed ranges, where the output frequency is $\geq n4-67$ [<i>Estimate Gain Switchover Freq</i>]. Usually it is not necessary to change this setting.</p>	1.00 (0.50 - 3.00)

If the drive detects *oS* [*Overspeed*] in no-load conditions, or if the speed does not become stable in the high speed range, increase or decrease the setting value in 0.05 unit increments.

■ n4-66: Flux Estimate Response @Low Freq

No. (Hex.)	Name	Description	Default (Range)
n4-66 (1B86)	Flux Estimate Response @Low Freq	<div style="display: flex; justify-content: space-between; font-size: small;"> V/f CL-V/f OLV CLV AOLV OLV/PM AOLV/PM CLV/PM EZOLV </div> <p>Sets the responsiveness of the magnetic flux estimation in low speed ranges, where $0 \leq$ the output frequency, which is $< n4-67$ [<i>Estimate Gain Switchover Freq</i>]. Usually it is not necessary to change this setting.</p>	1.50 (0.50 - 3.00)

If the drive detects *oS* [*Overspeed*] in no-load conditions, or if the speed does not become stable in the low speed range, increase or decrease the setting value in 0.05 unit increments.

■ n4-67: Estimate Gain Switchover Freq

No. (Hex.)	Name	Description	Default (Range)
n4-67 (1B87)	Estimate Gain Switchover Freq	<div style="display: flex; justify-content: space-between; font-size: small;"> V/f CL-V/f OLV CLV AOLV OLV/PM AOLV/PM CLV/PM EZOLV </div> <p>Sets the switching frequency for estimation gain for these parameters: <i>n4-63</i> [<i>Speed EstimateResponse@High Freq</i>] <i>n4-64</i> [<i>Speed Estimate Response@Low Freq</i>] <i>n4-65</i> [<i>Flux Estimate Response@High Freq</i>] <i>n4-66</i> [<i>Flux Estimate Response @Low Freq</i>] Usually it is not necessary to change this setting.</p>	6.00 Hz (0.00 - E1-04 setting)

When the output frequency $\geq n4-67$, the drive will select *n4-63* and *n4-65*. When the output frequency $< n4-67$, the drive will select *n4-64* and *n4-66*.

■ n4-68: Speed Estimation Filter Time

No. (Hex.)	Name	Description	Default (Range)
n4-68 (1B88)	Speed Estimation Filter Time	<div style="display: flex; justify-content: space-between; font-size: small;"> V/f CL-V/f OLV CLV AOLV OLV/PM AOLV/PM CLV/PM EZOLV </div> <p>Sets the primary delay time constant for the speed estimation value. Usually it is not necessary to change this setting.</p>	0.001 s (0.001 - 0.010 s)

If the motor speed oscillates in the high speed range, set the value to 0.010 s.

■ n4-69: Flux Control Response

No. (Hex.)	Name	Description	Default (Range)
n4-69 (1B89)	Flux Control Response	<div style="display: flex; justify-content: space-between; font-size: 0.8em;"> V/f CL-V/f OLV CLV AOLV OLV/PM AOLV/PM CLV/PM EZOLV </div> Unifies control of magnetic flux to make motor vibrations more stable.	1.00 (0.00 - 60.00)

If step-out occurs when the load changes, decrease the setting value in 1.00 increments.

Note:

If heavy loads decrease motor speed, increase the setting value in 1.00 increments. If it does not get better, increase *n4-74 [Limit of Flux Loop]* in 20% increments.

■ n4-70: Speed Command Comp @ Low Freq

No. (Hex.)	Name	Description	Default (Range)
n4-70 (1B8A)	Speed Command Comp @ Low Freq	<div style="display: flex; justify-content: space-between; font-size: 0.8em;"> V/f CL-V/f OLV CLV AOLV OLV/PM AOLV/PM CLV/PM EZOLV </div> Sets the function to make the drive more stable when operating at low speeds. Usually it is not necessary to change this setting.	1.00 Hz (0.00 - 6.00 Hz)

This function makes the control more stable when operating at low speeds. Increase the setting in 0.3 Hz increments at the time of low-speed references with no load.

Note:

If you increase this parameter to make the speed references for low speeds more stable, it can make the speed control less accurate.

■ n4-71: Flux Estimation Method

No. (Hex.)	Name	Description	Default (Range)
n4-71 (1B8B) Expert	Flux Estimation Method	<div style="display: flex; justify-content: space-between; font-size: 0.8em;"> V/f CL-V/f OLV CLV AOLV OLV/PM AOLV/PM CLV/PM EZOLV </div> Sets the flux estimation method. Usually it is not necessary to change this setting.	0 (0, 1)

0 : Method 1

1 : Method 2

■ n4-72: Speed Feedback Mode

No. (Hex.)	Name	Description	Default (Range)
n4-72 (1B8C)	Speed Feedback Mode	<div style="display: flex; justify-content: space-between; font-size: 0.8em;"> V/f CL-V/f OLV CLV AOLV OLV/PM AOLV/PM CLV/PM EZOLV </div> Sets the requirement for an encoder option when <i>A1-02 = 4 [Control Method Selection = Advanced Open Loop Vector]</i> .	0 (0, 1)

You can connect a PG-B3 or PG-X3 encoder option in AOLV control. You can use the encoder option for better speed control precision.

Note:

- When you use an encoder option in AOLV control to operate machinery, specialized tuning of the drive can be necessary. You should usually set *A1-02 = 3 [Control Method Selection = Closed Loop Vector]* when you use an encoder option.
- When you set this parameter to 1, also set the number of PG pulses in *F1-01 [Encoder 1 Pulse Count (PPR)]*.

0 : Without Encoder

1 : With Encoder

■ n4-73: PGo Recovery Selection

No. (Hex.)	Name	Description	Default (Range)
n4-73 (1B8D)	PGo Recovery Selection	<div style="display: flex; justify-content: space-between; font-size: 0.8em;"> V/f CL-V/f OLV CLV AOLV OLV/PM AOLV/PM CLV/PM EZOLV </div> Sets the restart mode to Without Encoder Mode or the With Encoder Mode when an encoder is disconnected.	0 (0, 1)

Set $A1-02 = 4$ [Control Method Selection = AOLV] and $n4-72 = 1$ [Speed Feedback Mode = With Encoder] to use this parameter.

Parameter $F1-02$ [Encoder Signal Loss Detect Sel] sets the drive response when the drive detects a disconnected encoder. This parameter sets the drive to start up in the Without Encoder Mode or With Encoder Mode if the drive detects PGo [Encoder (PG) Feedback Loss].

Note:

A PG-B3 encoder option is necessary to use this parameter. When you use a PG-X3 option, it is not necessary to set this parameter.

If the drive detects PGo , de-energize the drive and examine the wiring for the encoder.

0 : Without Encoder

1 : With Encoder

■ **n4-74: Limit of Flux Loop**

No. (Hex.)	Name	Description	Default (Range)
n4-74 (1B8E)	Limit of Flux Loop	V/f CL-V/f OLV CLV AOLV OLV/PM AOLV/PM CLV/PM EZOLV Sets the control level for flux loop control output.	250% (100 - 500%)

If the torque is not sufficient because of 100% or more loads, increase the setting value in 20% increments. If the setting is too high, overexcitation could occur and overheat the motor.

◆ **n5: Feed Forward Control**

Feed forward control increases the responsiveness of acceleration and deceleration as specified by the speed reference.

Increase $C5-01$ and $C5-03$ [ASR Proportional Gain] to apply feed forward control to machines that have low rigidity and are possible to have hunting and vibration or to machines that have a large quantity of inertia. When you use this function in CLV control, it also helps prevent overshoot. Refer to [Figure 12.144](#). Refer to [Figure 12.145](#) for more information about parameters related to feed forward control.

Set $A1-02$ [Control Method Selection] to one of these values to enable feed forward control:

- 3: Closed Loop Vector Control
- 4: Advanced OpenLoop Vector Control
- 6: PM Advanced Open Loop Vector
- 7: PM Closed Loop Vector Control

Note:

- You cannot use feed forward control to increase responsiveness in applications where you apply loads externally during run at constant speed.
- When you use the Droop control function, set $n5-01 = 0$ [Feed Forward Control Selection = Disabled].
- You cannot use feed forward control with motor 2.

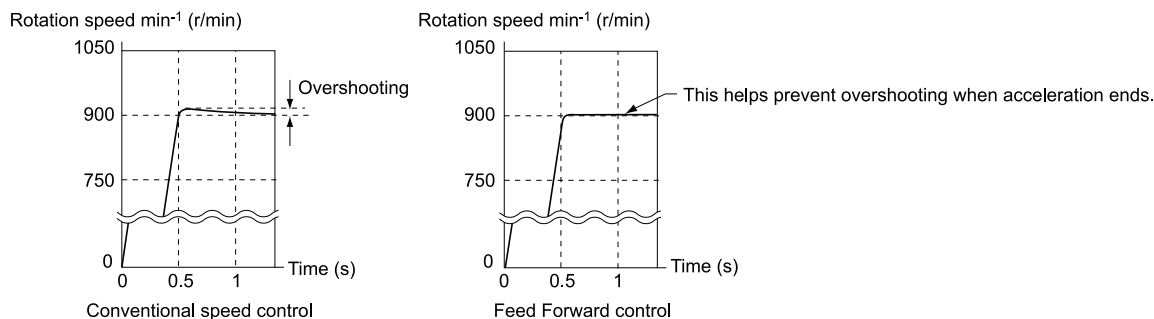

Figure 12.144 Suppress Overshooting with Feed Forward Control

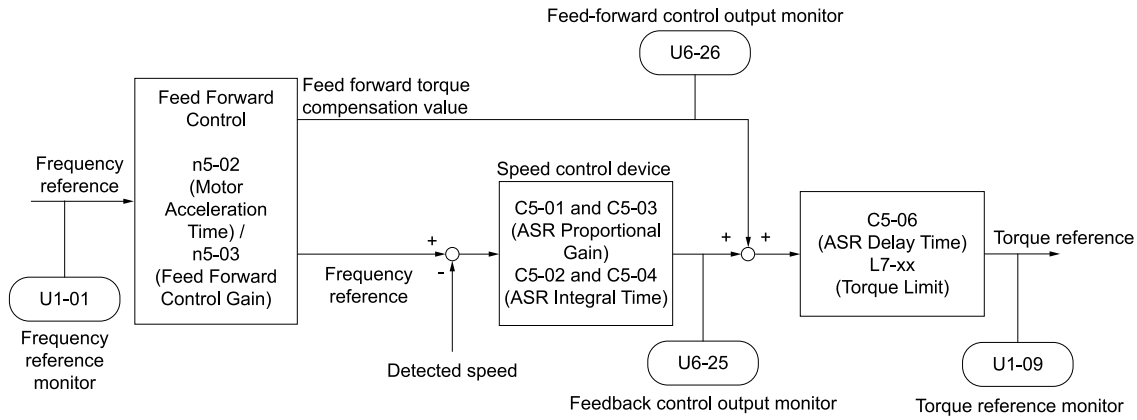

Figure 12.145 Configure Feed Forward Control

■ Before You Use Feed Forward Control

Do one of these procedures before you use feed forward control.

- Run Auto-Tuning to set motor parameters.
When you cannot do Auto-Tuning, manually set motor parameters with the information on the motor nameplate or test reports. Set the *E2 parameters* for induction motors. Set the *E5 parameters* for PM motors.
- Set *C5 parameters* [Automatic Speed Regulator (ASR)] individually to adjust the speed control loop (ASR).
- If you can connect a motor to a machine and rotate it during Auto-Tuning, do Inertia Tuning. The drive automatically adjusts feed forward parameters during Inertia Tuning.
- If you cannot do Inertia Tuning, refer to Figure 12.145 and set the parameters related to feed forward control individually.

■ n5-01: Feed Forward Control Selection

No. (Hex.)	Name	Description	Default (Range)
n5-01 (05B0)	Feed Forward Control Selection	V/f CL-V/f OLV CLV AOLV OLV/PM AOLV/PM CLV/PM EZOLV Sets the feed forward function.	0 (0, 1)

0 : Disabled

1 : Enabled

■ n5-02: Motor Inertia Acceleration Time

No. (Hex.)	Name	Description	Default (Range)
n5-02 (05B1)	Motor Inertia Acceleration Time	V/f CL-V/f OLV CLV AOLV OLV/PM AOLV/PM CLV/PM EZOLV Sets the length of time for the motor to accelerate from the stopped to the maximum frequency with a single motor at the rated torque. Inertia Tuning automatically sets the motor acceleration time.	Determined by C6-01, E5-01, and o2-04 (0.001 - 10.000 s)

If you cannot do Inertia Tuning, calculate the motor acceleration time as shown here or measure the motor acceleration time and set *n5-02* to this value.

Calculate the Motor Acceleration Time

Use this formula to find the motor acceleration time:

$$n5-02 = \frac{2\pi \cdot J_{\text{Motor}} \cdot n_{\text{rated}}}{60 \cdot T_{\text{rated}}}$$

- J_{Motor} = Moment of inertia of motor (kg m²)
- n_{rated} = Motor rated speed (min⁻¹, r/min)
- T_{rated} = Motor rated torque (N m)

You can also use this formula to find the motor acceleration time:

$$n5-02 = \frac{4\pi \cdot J_{\text{Motor}} \cdot f_{\text{rated}}}{p \cdot T_{\text{rated}}}$$

- f_{rated} = Motor rated frequency (Hz)
- P = Number of motor poles

Calculate the Motor Acceleration Time

Use this procedure to calculate the motor acceleration time:

1. Use *A1-02 [Control Method Selection]* to set the control method.
2. Disconnect the motor and load.
3. Run Auto-Tuning to set motor parameters.
When you cannot do Auto-Tuning, manually set motor parameters with the information on the motor nameplate or test reports. Set the *E2 parameters* for induction motors. Set the *E5 parameters* for PM motors.
4. Set *C5 parameters [Automatic Speed Regulator (ASR)]*.
5. Set *C1-01 [Acceleration Time 1] = 0*.
6. Set *L7-01 [Forward Torque Limit]* to 100%.
7. Set the frequency reference to the same value as the motor rated speed.
8. Measure the length of time for the motor to reach the rated speed.
Show *U1-05 [Motor Speed]* on the keypad and enter the Run command (forward run).
9. Stop the motor.
10. Set *n5-02* to the measured motor acceleration time value.

Reset all of the parameters that you changed to the previous setting values.

■ n5-03: Feed Forward Control Gain

No. (Hex.)	Name	Description	Default (Range)
n5-03 (05B2)	Feed Forward Control Gain	<div style="display: flex; justify-content: space-between; font-size: small;"> V/f CL-V/f OLV CLV AOLV OLV/PM AOLV/PM CLV/PM EZOLV </div> Sets the ratio between load inertia and motor inertia. Inertia Tuning automatically sets the Feedforward Control Gain value.	1.00 (0.00 - 100.00)

When you cannot do Inertia Tuning, use this procedure to set n5-03:

Set *n5-02 [Motor Inertia Acceleration Time]*.

1. Connect the motor and load.
2. Set *C1-01 [Acceleration Time 1] = 0*.
3. Use *L7-01 to L7-04 [Torque Limit]* to set the expected test run torque limit levels.
4. Set the frequency reference as specified by the high speed range of the machine.
5. Measure the length of time for the motor to reach the command reference speed.
Show *U1-05 [Motor Speed]* on the keypad and enter the Run command.
6. Stop the motor.
7. Replace the values in the this formula and set *n5-03* to the value of the formula.

$$n5-03 = \frac{t_{\text{accel}} \cdot T_{\text{Lim_Test}} \cdot f_{\text{rated}}}{n5-02 \cdot f_{\text{ref_Test}} \cdot 100} - 1$$

- t_{accel} = Acceleration time (s)
- f_{rated} = Motor rated frequency (Hz)
- $T_{\text{Lim_Test}}$ = Test run torque limit (%)
- $f_{\text{ref_Test}}$ = Test run frequency reference (Hz)

WARNING! *Sudden Movement Hazard. Machinery can accelerate suddenly. Do not use this function with machinery that must not accelerate suddenly. Sudden starts can cause serious injury or death.*

Reset all of the parameters that you changed to the previous setting values.

Note:

- If response to the speed reference is slow, increase the value set in *n5-03*.
- Increase the value set in *n5-03* when response to the speed reference is slow.
 - The speed is overshooting.
 - A negative torque reference is output when acceleration ends.

■ **n5-04: Speed Response Frequency**

No. (Hex.)	Name	Description	Default (Range)
n5-04 (05B3) RUN Expert	Speed Response Frequency	<div style="display: flex; justify-content: space-between; font-size: small;"> V/f CL-V/f OLV CLV AOLV OLV/PM AOLV/PM CLV/PM EZOLV </div> <p>Sets the response frequency for the speed reference. Usually it is not necessary to change this parameter.</p>	Determined by A1-02 (0.00 - 500.00 Hz)

If you set *n5-03* [*Feed Forward Control Gain*] too high, the motor speed will momentarily increase to more than the set frequency.

◆ **n6: Online Tuning**

n6 parameters are used to set the online tuning function for motor line-to-line resistance.

The Online Tuning for motor line-to-line resistance is used to prevent degradation of speed control accuracy due to motor temperature fluctuation and motor stalls due to insufficient torque.

■ **n6-01: Online Tuning Selection**

No. (Hex.)	Name	Description	Default (Range)
n6-01 (0570)	Online Tuning Selection	<div style="display: flex; justify-content: space-between; font-size: small;"> V/f CL-V/f OLV CLV AOLV OLV/PM AOLV/PM CLV/PM EZOLV </div> <p>Sets the type of motor data that Online Tuning uses for OLV control.</p>	0 (0 - 2)

0 : Disabled

1 : Line-to-Line Resistance Tuning

The drive adjusts the motor line-to-line resistance during run. This procedure is applicable for speed values 6 Hz and less. It also adjusts the motor resistance value to increase the overload capacity in the low speed range.

2 : Voltage Correction Tuning

The drive adjusts the output voltage during run to increase overload tolerance and minimize the effects of high temperatures on speed precision.

Note:

Setting 2 is enabled only when *b8-01* = 0 [*Energy Saving Control Selection = Disabled*].

■ **n6-05: Online Tuning Gain**

No. (Hex.)	Name	Description	Default (Range)
n6-05 (05C7) Expert	Online Tuning Gain	<div style="display: flex; justify-content: space-between; font-size: small;"> V/f CL-V/f OLV CLV AOLV OLV/PM AOLV/PM CLV/PM EZOLV </div> <p>Sets the compensation gain when <i>n6-01</i> = 2 [<i>Online Tuning Selection = Voltage Correction Tuning</i>]. Usually it is not necessary to change this parameter.</p>	1.0 (0.1 - 50.0)

When you use a motor that has a large secondary circuit time constant, decrease the setting value.

If the drive detects *oL1* [*Motor Overload*], increase the setting value in 0.1-unit increments.

■ **n6-11: Online Resistance Tuning**

No. (Hex.)	Name	Description	Default (Range)
n6-11 (1B56) Expert	Online Resistance Tuning	<div style="display: flex; justify-content: space-between; font-size: small;"> V/f CL-V/f OLV CLV AOLV OLV/PM AOLV/PM CLV/PM EZOLV </div> <p>Sets the responsiveness for online resistor tuning. Set this parameter to approximately 1.000 to enable the function. The function is disabled when the value is 0.000.</p>	0.000 (0.000 - 1.000)

◆ n7: EZ Drive

The *n7 parameters* provide special adjustments for EZ Vector Control.

■ n7-01: Damping Gain for Low Frequency

No. (Hex.)	Name	Description	Default (Range)
n7-01 (3111) Expert	Damping Gain for Low Frequency	V/f CL-V/f OLV CLV AOLV OLV/PM AOLV/PM CLV/PM EZOLV Sets the oscillation suppression gain for the low speed range.	1.0 (0.1 - 10.0)

Note:

- If oscillation occurs in the low speed range, increase the acceleration time or increase the setting value in 0.5-unit increments.
- To get starting torque with the setting for *C4-01 [Torque Compensation Gain]*, decrease the setting value in 0.3-unit increments.

■ n7-05: Response Gain for Load Changes

No. (Hex.)	Name	Description	Default (Range)
n7-05 (3115) Expert	Response Gain for Load Changes	V/f CL-V/f OLV CLV AOLV OLV/PM AOLV/PM CLV/PM EZOLV Sets the response gain related to changes in the load.	100 (10 - 1000)

Note:

To make tracking related to load changes better, increase the setting value in 5-unit increments. If oscillation occurs during load changes, decrease the setting value in 5-unit increments.

■ n7-07: Speed Calculation Gain1

No. (Hex.)	Name	Description	Default (Range)
n7-07 (3117) Expert	Speed Calculation Gain1	V/f CL-V/f OLV CLV AOLV OLV/PM AOLV/PM CLV/PM EZOLV Sets the speed calculation gain during usual operation. Usually it is not necessary to change this setting.	15.0 Hz (1.0 - 50.0 Hz)

■ n7-08: Speed Calculation Gain2

No. (Hex.)	Name	Description	Default (Range)
n7-08 (3118) Expert	Speed Calculation Gain2	V/f CL-V/f OLV CLV AOLV OLV/PM AOLV/PM CLV/PM EZOLV Sets the speed calculation gain during a speed search.	25.0 Hz (1.0 - 50.0 Hz)

Note:

When you increase the setting value, you can do a speed search of a motor rotating at a high frequency. If the setting value is too high, the calculated speed will oscillate and a restart will fail. Decrease the setting value in these conditions.

■ n7-10: Pull-in Current Switching Speed

No. (Hex.)	Name	Description	Default (Range)
n7-10 (311A) Expert	Pull-in Current Switching Speed	V/f CL-V/f OLV CLV AOLV OLV/PM AOLV/PM CLV/PM EZOLV Parameter <i>n8-51 [Pull-in Current @ Acceleration]</i> , is in effect when the output frequency is $\leq n7-10$, where the speed is set as a percentage of rated speed.	10.0% (0.0 - 100.0%)

Note:

- The value set in *n8-51 [Pull-in Current @ Acceleration]* is enabled for speeds that are not higher than *n7-10* during deceleration. The value set in *b8-01 [Energy Saving Control Selection]* is enabled for speeds higher than *n7-10*.
- If there is a large quantity of oscillation when you operate in the low speed range, increase the setting value.
- When it is most important to save energy in the low speed range, decrease the setting value.

■ n7-11: Pull-in Current Switch Hysteresis Band

No. (Hex.)	Name	Description	Default (Range)
n7-11 (311B) Expert	Pull-in Current Switch Hysteresis Band	<div style="display: flex; justify-content: space-between; font-size: 0.8em; font-weight: normal;"> V/f CL-V/f OLV CLV AOLV OLV/PM AOLV/PM CLV/PM EZOLV </div> <p>Sets the hysteresis level for Switching Speed set in <i>n7-10</i> [Pull-in Current Switching Speed]. When the speed is lower than <i>n7-10</i> + <i>n7-11</i> during acceleration, the drive enables pull-in current.</p>	5.0% (1.0 - 20.0%)

Note:

- The value set in *n8-51* [Pull-in Current @ Acceleration] is enabled for speeds that are not higher than *n7-10* + *n7-11* during acceleration. The value set in *b8-01* [Energy Saving Control Selection] is enabled for speeds higher than *n7-10* + *n7-11*.
- If there is a large quantity of oscillation when you operate in the low speed range, increase the setting value.
- When it is most important to save energy in the low speed range, decrease the setting value.

■ n7-13: Pull-in Current Switching Time

No. (Hex.)	Name	Description	Default (Range)
n7-13 (311D) Expert	Pull-in Current Switching Time	<div style="display: flex; justify-content: space-between; font-size: 0.8em; font-weight: normal;"> V/f CL-V/f OLV CLV AOLV OLV/PM AOLV/PM CLV/PM EZOLV </div> <p>Sets a time to enable the pull-in current commands.</p>	100 ms (0 - 1000 ms)

If there is a large quantity of oscillation at speeds around *n7-10* [Pull-in Current Switching Speed], decrease the setting in decrements of 20 ms.

■ n7-17: Resistance TemperatureCorrection

No. (Hex.)	Name	Description	Default (Range)
n7-17 (3122)	Resistance TemperatureCorrection	<div style="display: flex; justify-content: space-between; font-size: 0.8em; font-weight: normal;"> V/f CL-V/f OLV CLV AOLV OLV/PM AOLV/PM CLV/PM EZOLV </div> <p>Sets the function to adjust for changes in the motor resistance value caused by changes in the temperature.</p>	1 (0 to 2)

0 : Invalid

1 : Valid (Only 1 time)

2 : Valid (Every time)

Note:

- For settings 1 and 2, the adjustment time can cause a delay before startup.
- For settings 1 and 2, the drive can set the line-to-line resistance value of *E9-10* [Motor Line-to-Line Resistance].
- When the temperature will change at startup, use setting 2.
- To decrease the startup time, set this parameter to 0, then do line-to-line resistance tuning.
- If you will start from coasting, set this parameter to 0, then do line-to-line resistance tuning.

◆ n8: PM Motor Control Tuning

n8 parameters are used to make adjustments when controlling PM motors.

■ n8-01: Pole Position Detection Current

No. (Hex.)	Name	Description	Default (Range)
n8-01 (0540)	Pole Position Detection Current	<div style="display: flex; justify-content: space-between; font-size: 0.8em; font-weight: normal;"> V/f CL-V/f OLV CLV AOLV OLV/PM AOLV/PM CLV/PM EZOLV </div> <p>Sets, as a percentage, the Initial Rotor Position Estimated Current, taking the <i>E5-03</i> [Motor Rated Current (FLA)] as the 100% value. Usually it is not necessary to change this setting.</p>	50% (0 - 100%)

The drive uses the Initial Rotor Position Estimated Current to detect the initial position of rotors. Use the "Si" value on the motor nameplate, if available.

Note:

When *A1-02* = 7 [CLV/PM], this parameter takes effect only in Expert Mode.

■ n8-02: Pole Alignment Current Level

No. (Hex.)	Name	Description	Default (Range)
n8-02 (0541) Expert	Pole Alignment Current Level	V/f CL-V/f OLV CLV AOLV OLV/PM AOLV/PM CLV/PM EZOLV Sets the current at the time of polar attraction as a percentage of <i>E5-03 [Motor Rated Current (FLA)]</i> . Usually it is not necessary to change this setting.	80% (0 - 150%)

The drive uses the polar pull-in current to attract the rotor after it detects the initial rotor position. When you increase the value of *n8-02*, the starting torque also increases.

- If the motor does not track correctly at the time of the polar attraction, increase the value in 10% increments. If you set the value too high, the drive will detect *oL2 [Drive Overloaded]*.
- If the motor oscillates at the time of the polar attraction, decrease the value in 10% increments.

Note:

- This function is available when you set *A1-02 = 7 [Control Method Selection = CLV/PM]* and do Rotational Auto-Tuning or Z Pulse Offset Tuning.
- When *A1-02 = 7*, this parameter takes effect only in Expert Mode.

■ n8-03: Pole Position Detection Time

No. (Hex.)	Name	Description	Default (Range)
n8-03 (0542)	Pole Position Detection Time	V/f CL-V/f OLV CLV AOLV OLV/PM AOLV/PM CLV/PM EZOLV Sets the length of the Current Starting Time, which is used for Z Pulse Offset Tuning. Usually it is not necessary to change this setting.	1.5 s (1.5 - 5.0 s)

Sets the length of time of pull-in current when the drive detects the motor magnetic pole of the rotors.

Note:

If the motor oscillates at the time of the polar attraction, increase the value in 0.5 s increments. If the value is too high, the drive can detect *oL2 [Drive Overloaded]*.

■ n8-04: Pole Alignment Time

No. (Hex.)	Name	Description	Default (Range)
n8-04 (0543) Expert	Pole Alignment Time	V/f CL-V/f OLV CLV AOLV OLV/PM AOLV/PM CLV/PM EZOLV Sets the length of the Polar Attraction Time, which is used for Z Pulse Offset Tuning. Usually it is not necessary to change this setting.	1.5 s (1.5 - 5.0 s)

Sets the length of time that the pull-in current flows when the drive detects the motor magnetic pole of the rotors.

Note:

If the motor oscillates at the time of the polar attraction, increase the value in 0.5 s increments. If you set the value too high, the drive will detect *oL2 [Drive Overloaded]*.

■ n8-11: Observer Calculation Gain 2

No. (Hex.)	Name	Description	Default (Range)
n8-11 (054A)	Observer Calculation Gain 2	V/f CL-V/f OLV CLV AOLV OLV/PM AOLV/PM CLV/PM EZOLV Sets the gain for speed estimation. Usually it is not necessary to change this setting.	Determined by n8-72 (0.0 - 1000.0)

Note:

When *n8-72 = 0 [Speed Estimation Method Select = Method 1]*, the default value is 50.0. When *n8-72 = 1 [Method 2]*, the default value is 150.0.

■ n8-14: Polarity Compensation Gain 3

No. (Hex.)	Name	Description	Default (Range)
n8-14 (054D) Expert	Polarity Compensation Gain ³	V/f CL-V/f OLV CLV AOLV OLV/PM AOLV/PM CLV/PM EZOLV Sets the gain for speed estimation. Usually it is not necessary to change this setting.	1.000 (0.000 - 10.000)

■ n8-15: Polarity Compensation Gain 4

No. (Hex.)	Name	Description	Default (Range)
n8-15 (054E) Expert	Polarity Compensation Gain 4	<div style="display: flex; justify-content: space-between; font-size: 0.8em; margin-bottom: 5px;"> V/f CL-V/f OLV CLV AOLV OLV/PM AOLV/PM CLV/PM EZOLV </div> Sets the gain for speed estimation. Usually it is not necessary to change this setting.	0.500 (0.000 - 10.000)

■ n8-21: Motor Back-EMF (Ke) Gain

No. (Hex.)	Name	Description	Default (Range)
n8-21 (0554) Expert	Motor Back-EMF (Ke) Gain	<div style="display: flex; justify-content: space-between; font-size: 0.8em; margin-bottom: 5px;"> V/f CL-V/f OLV CLV AOLV OLV/PM AOLV/PM CLV/PM EZOLV </div> Sets the gain for speed estimation. Usually it is not necessary to change this setting.	0.90 (0.80 - 1.00)

■ n8-23: ACR q Gain @PoleEst

No. (Hex.)	Name	Description	Default (Range)
n8-23 (0556) Expert	ACR q Gain @PoleEst	<div style="display: flex; justify-content: space-between; font-size: 0.8em; margin-bottom: 5px;"> V/f CL-V/f OLV CLV AOLV OLV/PM AOLV/PM CLV/PM EZOLV </div> Sets the proportional gain for current regulator q-axis control when the drive estimates the initial pole. Usually it is not necessary to change this setting.	0 (0 - 2000)

■ n8-24: ACR q Integral Time @PoleEst

No. (Hex.)	Name	Description	Default (Range)
n8-24 (0557) Expert	ACR q Integral Time @PoleEst	<div style="display: flex; justify-content: space-between; font-size: 0.8em; margin-bottom: 5px;"> V/f CL-V/f OLV CLV AOLV OLV/PM AOLV/PM CLV/PM EZOLV </div> Sets the integral time for current regulator q-axis control when the drive estimates the initial pole. Usually it is not necessary to change this setting.	0.0 ms (0.0 - 100.0 ms)

■ n8-25: ACR q Limit @PoleEst

No. (Hex.)	Name	Description	Default (Range)
n8-25 (0558) Expert	ACR q Limit @PoleEst	<div style="display: flex; justify-content: space-between; font-size: 0.8em; margin-bottom: 5px;"> V/f CL-V/f OLV CLV AOLV OLV/PM AOLV/PM CLV/PM EZOLV </div> Sets the q-axis limit of the current regulator when the drive estimates the initial pole. Usually it is not necessary to change this setting.	0% (0 - 150%)

■ n8-26: ACR d Gain @PoleEst

No. (Hex.)	Name	Description	Default (Range)
n8-26 (0559) Expert	ACR d Gain @PoleEst	<div style="display: flex; justify-content: space-between; font-size: 0.8em; margin-bottom: 5px;"> V/f CL-V/f OLV CLV AOLV OLV/PM AOLV/PM CLV/PM EZOLV </div> Sets the proportional gain for current regulator d-axis control when the drive estimates the initial pole. Usually it is not necessary to change this setting.	500 (0 - 2000)

■ n8-27: ACR d Integral Time @PoleEst

No. (Hex.)	Name	Description	Default (Range)
n8-27 (055A) Expert	ACR d Integral Time @PoleEst	<div style="display: flex; justify-content: space-between; font-size: 0.8em; margin-bottom: 5px;"> V/f CL-V/f OLV CLV AOLV OLV/PM AOLV/PM CLV/PM EZOLV </div> Sets the integral time for current regulator d-axis control when the drive estimates the initial pole. Usually it is not necessary to change this setting.	0.0 ms (0.0 - 100.0 ms)

■ n8-28: ACR d Lim @PoleEst

No. (Hex.)	Name	Description	Default (Range)
n8-28 (055B) Expert	ACR d Lim @PoleEst	<div style="display: flex; justify-content: space-between; font-size: 0.8em;"> V/f CL-V/f OLV CLV AOLV OLV/PM AOLV/PM CLV/PM EZOLV </div> <p>Sets the d-axis limit of the current regulator when the drive estimates the initial pole. Usually it is not necessary to change this setting.</p>	100% (0 - 150%)

■ n8-35: Initial Pole Detection Method

No. (Hex.)	Name	Description	Default (Range)
n8-35 (0562)	Initial Pole Detection Method	<div style="display: flex; justify-content: space-between; font-size: 0.8em;"> V/f CL-V/f OLV CLV AOLV OLV/PM AOLV/PM CLV/PM EZOLV </div> <p>Sets how the drive detects the position of the rotor at start.</p>	Determined by A1-02 (0 - 2)

When you set $A1-02 = 7$ [*Control Method Selection = CLV/PM*], the initial motor magnetic pole detection operates the first time after you energize the drive. After that, the drive uses the encoder signal to calculate the rotor position and the drive saves the value until you de-energize the drive. If you use an absolute value encoder, the initial motor magnetic pole detection will not operate.

Note:

- When you operate an SPM motor, set $n8-35 = 0$. When you operate an IPM motor, you can set $n8-35 = 0$ to 2.
- When you set $n8-35 = 1$, do High Frequency Injection Auto-Tuning.
- When you set $n8-35 = 0$ or 2, you must examine the drive and machinery setup that you use for the application. If the drive incorrectly detects the polarity, the drive can rotate in the direction opposite of the Run command.

0 : Pull-in

Starts the rotor with pull-in current.

1 : High Frequency Injection

Injects high frequency to detect the rotor position. This setting can cause a loud excitation sound when the motor starts.

Note:

When you set this to 1, do High Frequency Injection Auto-Tuning.

2 : Pulse Injection

Inputs the pulse signal to the motor to detect the rotor position.

■ n8-36: HFI Frequency Level for L Tuning

No. (Hex.)	Name	Description	Default (Range)
n8-36 (0563)	HFI Frequency Level for L Tuning	<div style="display: flex; justify-content: space-between; font-size: 0.8em;"> V/f CL-V/f OLV CLV AOLV OLV/PM AOLV/PM CLV/PM EZOLV </div> <p>Sets the injection frequency for high frequency injection.</p>	500 Hz (200 - 1000 Hz)

Note:

- Set $n8-35 = 1$ [*Initial Pole Detection Method = High Frequency Injection*] or $n8-57 = 1$ [*HFI Overlap Selection = Enabled*] to enable this parameter.
- The drive automatically calculates this value when High Frequency Injection Auto-Tuning completes successfully.

■ n8-37: HFI Voltage Amplitude Level

No. (Hex.)	Name	Description	Default (Range)
n8-37 (0564) Expert	HFI Voltage Amplitude Level	<div style="display: flex; justify-content: space-between; font-size: 0.8em;"> V/f CL-V/f OLV CLV AOLV OLV/PM AOLV/PM CLV/PM EZOLV </div> <p>Sets the high frequency injection amplitude as a percentage where 200 V = 100% for 200 V class drives and 400 V = 100% for a 400 V class drives. Usually it is not necessary to change this setting.</p>	20.0% (0.0 - 50.0%)

Note:

Set $n8-35 = 1$ [*Initial Pole Detection Method = High Frequency Injection*] or $n8-57 = 1$ [*HFI Overlap Selection = Enabled*] to enable this parameter.

The drive automatically calculates this value when High Frequency Injection Auto-Tuning completes successfully.

■ n8-39: HFI LPF Cutoff Freq

No. (Hex.)	Name	Description	Default (Range)
n8-39 (0566)	PM Phase Compensation Gain	<div style="display: flex; justify-content: space-between; font-size: 0.8em;"> V/f CL-V/f OLV CLV AOLV OLV/PM AOLV/PM CLV/PM EZOLV </div> Sets the low-pass filter shut-off frequency for high frequency injection.	250 Hz (0 - 1000 Hz)

Note:

- Set $n8-35 = 1$ [Initial Pole Detection Method = High Frequency Injection] or $n8-57 = 1$ [HFI Overlap Selection = Enabled] to enable this parameter.
- The drive automatically calculates this value when High Frequency Injection Auto-Tuning completes successfully.

■ n8-41: HFI P Gain

No. (Hex.)	Name	Description	Default (Range)
n8-41 (0568) Expert	HFI P Gain	<div style="display: flex; justify-content: space-between; font-size: 0.8em;"> V/f CL-V/f OLV CLV AOLV OLV/PM AOLV/PM CLV/PM EZOLV </div> Sets the response gain for the high frequency injection speed estimation.	2.5 (-10.0 - +10.0)

Note:

- Set $n8-35 = 1$ [Initial Pole Detection Method = High Frequency Injection] or $n8-57 = 1$ [HFI Overlap Selection = Enabled] to enable this parameter.
- Set $n8-41 > 0.0$ for IPM motors.

Configure the setting as follows.

- Decrease the setting in units of 0.5 if an oscillation or hunting occurs.
- Increase the setting in units of 0.5 if tracking related to load changes is required.

■ n8-42: HFI I Time

No. (Hex.)	Name	Description	Default (Range)
n8-42 (0569) Expert	HFI I Time	<div style="display: flex; justify-content: space-between; font-size: 0.8em;"> V/f CL-V/f OLV CLV AOLV OLV/PM AOLV/PM CLV/PM EZOLV </div> Sets the integral time constant for the high frequency injection speed estimation. Usually it is not necessary to change this setting.	0.10 s (0.00 - 9.99 s)

Note:

Set $n8-35 = 1$ [Initial Pole Detection Method = High Frequency Injection] or $n8-57 = 1$ [HFI Overlap Selection = Enabled] to enable this parameter.

■ n8-45: Speed Feedback Detection Gain

No. (Hex.)	Name	Description	Default (Range)
n8-45 (0538)	Speed Feedback Detection Gain	<div style="display: flex; justify-content: space-between; font-size: 0.8em;"> V/f CL-V/f OLV CLV AOLV OLV/PM AOLV/PM CLV/PM EZOLV </div> Sets the internal speed feedback detection reduction unit gain as a magnification value. Usually it is not necessary to change this setting.	0.80 (0.00 - 10.00)

Adjust this parameter in these conditions:

- If vibration or hunting occur, increase the setting value in 0.05 unit increments.
- If the responsiveness of torque and speed is unsatisfactory, decrease the setting value 0.05 unit increments and examine the response.

■ n8-46: PM Phase Compensation Gain

No. (Hex.)	Name	Description	Default (Range)
n8-46 (0539) Expert	PM Phase Compensation Gain	<div style="display: flex; justify-content: space-between; font-size: 0.8em;"> V/f CL-V/f OLV CLV AOLV OLV/PM AOLV/PM CLV/PM EZOLV </div> Sets the gain to compensate for phase differences. Usually it is not necessary to change this setting.	0.3 (0.0 - 10.0)

If there is vibration in the motor, increase the value. When you must detect oC [Overcurrent] or ov [DC Bus Overvoltage], set this parameter to a low value.

■ n8-47: Pull-in Current Comp Filter Time

No. (Hex.)	Name	Description	Default (Range)
n8-47 (053A)	Pull-in Current Comp Filter Time	<div style="display: flex; justify-content: space-between; font-size: small;"> V/f CL-V/f OLV CLV AOLV OLV/PM AOLV/PM CLV/PM EZOLV </div> <p>Sets the time constant the drive uses to align the pull-in current reference value with the actual current value. Usually it is not necessary to change this setting.</p>	5.0 s (0.0 - 100.0 s)

Adjust this parameter in these conditions:

- If the time for the reference value of the pull-in current to align with the target value is too long, increase the setting value.
- If vibration or hunting occur, decrease the setting value in 0.2 unit increments.
- If the motor stalls during run at constant speed, decrease the setting value in 0.2 unit increments.

■ n8-48: Pull-in/Light Load Id Current

No. (Hex.)	Name	Description	Default (Range)
n8-48 (053B)	Pull-in/Light Load Id Current	<div style="display: flex; justify-content: space-between; font-size: small;"> V/f CL-V/f OLV CLV AOLV OLV/PM AOLV/PM CLV/PM EZOLV </div> <p>On the basis that parameter <i>E5-03 [Motor Rated Current (FLA)]</i> is the 100% value, this parameter sets the d-axis current that flows to the motor during run at constant speed as a percentage.</p>	30% (0 - 200%)

Adjust in the following situations.

- Slightly reduce this value if there is too much current when driving a light load at a constant speed.
- Increase the setting value in steps of 5% when hunting or vibration occurs during run at constant speed.
- Increase the setting value in steps of 5% if the motor stalls during run at constant speed.

■ n8-49: Heavy Load Id Current

No. (Hex.)	Name	Description	Default (Range)
n8-49 (053C)	Heavy Load Id Current	<div style="display: flex; justify-content: space-between; font-size: small;"> V/f CL-V/f OLV CLV AOLV OLV/PM AOLV/PM CLV/PM EZOLV </div> <p>Sets the d-axis current to that the drive will supply to the motor to run it at a constant speed with a heavy load. Considers <i>E5-03 [PM Motor Rated Current (FLA)]</i> to be 100%. Usually it is not necessary to change this setting.</p>	Determined by E5-01 (-200.0 - +200.0%)

When you use an IPM motor, you can use the reluctance torque of the motor to make the motor more efficient and help conserve energy.

When you operate an SPN motor, set this parameter to 0.

Adjust this parameter in these conditions:

- If the load is large and motor rotation is not stable, decrease the setting value.
- If you change the *E5 parameters [PM Motor Settings]*, set *n8-49 = 0*, then adjust this parameter.

■ n8-50: Medium Load Iq Level (High)

No. (Hex.)	Name	Description	Default (Range)
n8-50 (053D)	Medium Load Iq Level (High)	<div style="display: flex; justify-content: space-between; font-size: small;"> V/f CL-V/f OLV CLV AOLV OLV/PM AOLV/PM CLV/PM EZOLV </div> <p>Sets the load current level to start high efficiency control as a percentage of <i>E5-03 [PM Motor Rated Current (FLA)]</i>. Usually it is not necessary to change this setting.</p>	80% (50 - 255%)

■ n8-51: Pull-in Current @ Acceleration

No. (Hex.)	Name	Description	Default (Range)
n8-51 (053E)	Pull-in Current @ Acceleration	<div style="display: flex; justify-content: space-between; font-size: small;"> V/f CL-V/f OLV CLV AOLV OLV/PM AOLV/PM CLV/PM EZOLV </div> <p>Sets the pull-in current allowed to flow during acceleration/deceleration as a percentage of the motor rated current.</p>	Determined by A1-02 (0 - 200%)

Adjust in the following situations.

- When the motor does not smoothly because of large loads, increase the setting value in 5% increments.

- If too much current flows during acceleration, decrease the setting value.

Note:

When $A1-02 = 8$ [Control Method Selection = EZOLV], this parameter will always be in effect for speed ranges less than $n7-10$ [Pull-in Current Switching Speed].

■ **n8-52: ACR P Gain**

No. (Hex.)	Name	Description	Default (Range)
n8-52 (053F) Expert	ACR P Gain	<div style="display: flex; justify-content: space-between; font-size: 0.8em;"> V/f CL-V/f OLV CLV AOLV OLV/PM AOLV/PM CLV/PM EZOLV </div> <p>Sets the proportional gain of the current regulator. Usually it is not necessary to change this setting.</p>	10.0 (-100.0 - 100.0)

■ **n8-54: Voltage Error Compensation Time**

No. (Hex.)	Name	Description	Default (Range)
n8-54 (056D) Expert	Voltage Error Compensation Time	<div style="display: flex; justify-content: space-between; font-size: 0.8em;"> V/f CL-V/f OLV CLV AOLV OLV/PM AOLV/PM CLV/PM EZOLV </div> <p>Sets the time constant that the drive uses when adjusting for voltage errors.</p>	1.00 s (0.00 - 10.00 s)

Adjust this parameter in these conditions:

- If oscillation occurs at the time of start up, increase the setting value.
- If hunting occurs when operating at low speed, increase the setting value.
- If fast changes in the load cause hunting, increase the setting value in 0.1-unit increments. If you cannot stop hunting, set $n8-51$ [Pull-in Current @ Acceleration] to 0% and set $n8-54$ to 0.00 s, and disable compensation for voltage errors.

■ **n8-55: Motor to Load Inertia Ratio**

No. (Hex.)	Name	Description	Default (Range)
n8-55 (056E)	Motor to Load Inertia Ratio	<div style="display: flex; justify-content: space-between; font-size: 0.8em;"> V/f CL-V/f OLV CLV AOLV OLV/PM AOLV/PM CLV/PM EZOLV </div> <p>Sets the ratio between motor inertia and machine inertia.</p>	0 (0 - 3)

Adjust in the following situations.

- If torque and speed response is unsatisfactory, gradually increase the setting from 0.
- If the motor does not run smoothly, gradually increase the setting from 0.
- If the motor stalls during run at constant speed, gradually increase the setting from 0.
- If there is vibration or hunting, decrease the setting.

Note:

- If the value is set too low, the drive will detect *STPo* [Motor Step-Out Detected].
- If you use one motor or more than motor at low inertia and the value is too high, there can be vibration in the motor.

0 : Below 1:10

Use this setting in these conditions:

- The ratio between the motor inertia and machine inertia is less than 1:10
- There are large current ripples

1 : Between 1:10 and 1:30

Use this setting in these conditions:

- The ratio between the motor inertia and machine inertia is approximately 1:10 to 1:30
- Parameter $n8-55 = 0$ and the drive detects *STPo* because of an impact load or sudden acceleration/deceleration.

2 : Between 1:30 and 1:50

Use this setting in these conditions:

- The ratio between the motor inertia and machine inertia is approximately 1:30 to 1:50
- Parameter $n8-55 = 1$ and the drive detects *STPo* because of an impact load or sudden acceleration/deceleration.

3 : Beyond 1:50

Adjust in the following situations.

- The ratio between the motor inertia and machine inertia is more than 1:50
- Parameter $n8-55 = 2$ and the drive detects *STPo* because of an impact load or sudden acceleration/deceleration.

■ n8-56: PM High Performance Selection

No. (Hex.)	Name	Description	Default (Range)
n8-56 (056F) Expert	PM High Performance Selection	<div style="display: flex; justify-content: space-between; font-size: small;"> V/f CL-V/f OLV CLV AOLV OLV/PM AOLV/PM CLV/PM EZOLV </div> <p>Usually it is not necessary to change this setting. Sets the high efficiency control method for IPM motor.</p>	1 (0 - 2)

0 : Disabled

1 : Enabled (Vd)

2 : Enabled (Vd & Vq)

■ n8-57: HFI Overlap Selection

No. (Hex.)	Name	Description	Default (Range)
n8-57 (0574)	HFI Overlap Selection	<div style="display: flex; justify-content: space-between; font-size: small;"> V/f CL-V/f OLV CLV AOLV OLV/PM AOLV/PM CLV/PM EZOLV </div> <p>Sets the function that detects motor speed with high frequency injection.</p>	0 (0, 1)

Note:

- When you set $n8-57 = 1$, doHigh Frequency Injection Auto-Tuning.
- When there is high frequency injection, the motor will make an excitation sound.
- When you use Zero Speed Control, set $E1-09$ [Minimum Output Frequency] = 0.0.

0 : Disabled

Use this setting with SPM motors. The speed control range is approximately 1:20.

When $n8-57 = 0$, you cannot set $E1-09$ [Minimum Output Frequency] $\leq 1/20$ of the value of $E1-06$ [Base Frequency].

1 : Enabled

The speed control range changes to 1:100 to give sufficient speed detection at low speeds.

Note:

It is not available with an SPM motor.

■ n8-62: Output Voltage Limit Level

No. (Hex.)	Name	Description	Default (Range)
n8-62 (057D) Expert	Output Voltage Limit Level	<div style="display: flex; justify-content: space-between; font-size: small;"> V/f CL-V/f OLV CLV AOLV OLV/PM AOLV/PM CLV/PM EZOLV </div> <p>Sets the output voltage limit to prevent saturation of the output voltage. Usually it is not necessary to change this parameter.</p>	200 V Class: 200.0 V, 400 V Class: 400.0 V (200 V Class: 0.0 to 240.0 V, 400 V Class: 0.0 to 480.0 V)

Set this parameter lower than the input power supply voltage.

Note:

- When $A1-02 = 7, 8$ [Control Method Selection = CLV/PM, EZOLV], this parameter is available in Expert Mode.
- When $A1-02 = 8$, the default setting is
 –200 V Class: 230.0 V
 –400 V Class: 460.0 V

■ n8-63: Output Voltage Limit P Gain

No. (Hex.)	Name	Description	Default (Range)
n8-63 (057E) Expert	Output Voltage Limit P Gain	<div style="display: flex; justify-content: space-between; font-size: small;"> V/f CL-V/f OLV CLV AOLV OLV/PM AOLV/PM CLV/PM EZOLV </div> <p>Sets the proportional gain for output voltage control. Usually it is not necessary to change this setting.</p>	1.00 (0.00 - 100.00)

■ **n8-64: Output Voltage Limit I Time**

No. (Hex.)	Name	Description	Default (Range)
n8-64 (057F) Expert	Output Voltage Limit I Time	<div style="display: flex; justify-content: space-between; font-size: 0.8em; margin-bottom: 5px;"> V/f CL-V/f OLV CLV AOLV OLV/PM AOLV/PM CLV/PM EZOLV </div> Sets the integral time for output voltage control. Usually it is not necessary to change this setting. Usually it is not necessary to change this setting.	0.040 s (0.000 - 5.000)

■ **n8-65: Speed Fdbk Gain @ oV Suppression**

No. (Hex.)	Name	Description	Default (Range)
n8-65 (065C) Expert	Speed Fdbk Gain @ oV Suppression	<div style="display: flex; justify-content: space-between; font-size: 0.8em; margin-bottom: 5px;"> V/f CL-V/f OLV CLV AOLV OLV/PM AOLV/PM CLV/PM EZOLV </div> Sets the gain of internal speed feedback detection suppression while the overvoltage suppression function is operating as a magnification value. Usually it is not necessary to change this parameter.	1.50 (0.00 - 10.00)

Adjust this parameter in these conditions:

- If there is resonance or hunting when you use the overvoltage suppression function, increase the setting value.
- If motor response is low when you use the overvoltage suppression function, decrease the setting value in 0.05-unit increments.

■ **n8-66: Output Voltage Limit Filter Time**

No. (Hex.)	Name	Description	Default (Range)
n8-66 (0235) Expert	Output Voltage Limit Filter Time	<div style="display: flex; justify-content: space-between; font-size: 0.8em; margin-bottom: 5px;"> V/f CL-V/f OLV CLV AOLV OLV/PM AOLV/PM CLV/PM EZOLV </div> Sets the filter time constant for output voltage control. Usually it is not necessary to change this setting.	0.020 s (0.000 - 5.000)

■ **n8-69: Speed Observer Control P Gain**

No. (Hex.)	Name	Description	Default (Range)
n8-69 (065D) Expert	Speed Observer Control P Gain	<div style="display: flex; justify-content: space-between; font-size: 0.8em; margin-bottom: 5px;"> V/f CL-V/f OLV CLV AOLV OLV/PM AOLV/PM CLV/PM EZOLV </div> Usually it is not necessary to change this setting. Sets the Proportional gain that the drive uses for speed estimation.	1.00 (0.00 - 20.00)

■ **n8-70: Speed Observer Control I Time**

No. (Hex.)	Name	Description	Default (Range)
n8-70 (065E) Expert	Speed Observer Control I Time	<div style="display: flex; justify-content: space-between; font-size: 0.8em; margin-bottom: 5px;"> V/f CL-V/f OLV CLV AOLV OLV/PM AOLV/PM CLV/PM EZOLV </div> Sets the speed estimator integral time constant. It is available when $n8-72 = 1$ [Speed Estimation Method Select = Method 2]. Usually it is not necessary to change this setting.	0.0 s (0.0 - 100.0 s)

■ **n8-71: Speed Observer Control D Gain**

No. (Hex.)	Name	Description	Default (Range)
n8-71 (065F) Expert	Speed Observer Control D Gain	<div style="display: flex; justify-content: space-between; font-size: 0.8em; margin-bottom: 5px;"> V/f CL-V/f OLV CLV AOLV OLV/PM AOLV/PM CLV/PM EZOLV </div> Set the speed estimator differential gain. It is available when $n8-72 = 1$ [Speed Estimation Method Select = Method 2]. Usually it is not necessary to change this setting.	5.00 (0.00 - 50.00)

■ **n8-72: Speed Estimation Method Select**

No. (Hex.)	Name	Description	Default (Range)
n8-72 (0655) Expert	Speed Estimation Method Select	<div style="display: flex; justify-content: space-between; font-size: 0.8em; margin-bottom: 5px;"> V/f CL-V/f OLV CLV AOLV OLV/PM AOLV/PM CLV/PM EZOLV </div> Selects the speed estimation method. Usually it is not necessary to change this setting.	1 (0, 1)

0 : Method 1

1 : Method 2

■ n8-73: Observer Mode Switch-Over Speed

No. (Hex.)	Name	Description	Default (Range)
n8-73 (0656) Expert	Observer Mode Switch-Over Speed	V/f CL-V/f OLV CLV AOLV OLV/PM AOLV/PM CLV/PM EZOLV Sets the speed level for pull-in current control at motor start as a percentage of E1-06 [Base Frequency]. Usually it is not necessary to change this setting.	10% (0 - 100%)

■ n8-74: Light Load Iq Level

No. (Hex.)	Name	Description	Default (Range)
n8-74 (05C3)	Light Load Iq Level	V/f CL-V/f OLV CLV AOLV OLV/PM AOLV/PM CLV/PM EZOLV Set n8-48 [Pull-in/Light Load Id Current] to the percentage of load current (q-axis current) that you will apply, where E5-03 [Motor Rated Current (FLA)] = a setting value of 100%.	30% (0 - 255%)

Note:

- If n8-74 > n8-75 [Medium Load Iq Level (low)], the drive will detect oPE08 [Parameter Selection Error].
- The change is linear between n8-74 and n8-75 and the level of the pull-in current from n8-48 to n8-78 [Medium Load Id Current].

■ n8-75: Medium Load Iq Level (low)

No. (Hex.)	Name	Description	Default (Range)
n8-75 (05C4)	Medium Load Iq Level (low)	V/f CL-V/f OLV CLV AOLV OLV/PM AOLV/PM CLV/PM EZOLV Set n8-78 [Medium Load Id Current] to the percentage of load current (q-axis current) that you will apply, where E5-03 [Motor Rated Current (FLA)] = a setting value of 100%.	50% (0 - 255%)

Note:

- If n8-74 [Light Load Iq Level] > n8-75, the drive will detect oPE08 [Parameter Selection Error].
- The change is linear between n8-74 and n8-75 and the level of the pull-in current from n8-48 to n8-78 [Medium Load Id Current].

■ n8-76: Id Switching Filter Time

No. (Hex.)	Name	Description	Default (Range)
n8-76 (05CD) Expert	Id Switching Filter Time	V/f CL-V/f OLV CLV AOLV OLV/PM AOLV/PM CLV/PM EZOLV Sets the filter time constant for d-axis current reference. Usually it is not necessary to change this setting.	200 ms (0 - 5000 ms)

■ n8-77: Heavy Load Iq Level

No. (Hex.)	Name	Description	Default (Range)
n8-77 (05CE)	Heavy Load Iq Level	V/f CL-V/f OLV CLV AOLV OLV/PM AOLV/PM CLV/PM EZOLV Set n8-49 [Heavy Load Id Current] to the percentage of load current (q-axis current) that you will apply, where E5-03 [Motor Rated Current (FLA)] = a setting value of 100%.	90% (0 - 255%)

Note:

The change is linear between n8-75 [Medium Load Iq Level (low)] and n8-77 and the level of the pull-in current from n8-78 [Medium Load Id Current] to n8-49 [Heavy Load Id Current].

■ n8-78: Medium Load Id Current

No. (Hex.)	Name	Description	Default (Range)
n8-78 (05F4)	Medium Load Id Current	V/f CL-V/f OLV CLV AOLV OLV/PM AOLV/PM CLV/PM EZOLV Sets the level of the pull-in current for mid-range loads.	0% (-200 - +200%)

■ n8-79: Pull-in Current @ Deceleration

No. (Hex.)	Name	Description	Default (Range)
n8-79 (05FE)	Pull-in Current @ Deceleration	<div style="display: flex; justify-content: space-between; font-size: 0.8em;"> V/f CL-V/f OLV CLV AOLV OLV/PM AOLV/PM CLV/PM EZOLV </div> <p>Sets the pull-in current that can flow during deceleration as a percentage of the <i>E5-03 [PM Motor Rated Current (FLA)]</i>.</p>	50% (0 - 200%)

If overcurrent occurs during deceleration, slowly decrease the setting in 5% increments.

Note:

When $n8-79 = 0$, the drive will use the value set in $n8-51$ [*Pull-in Current @ Acceleration*].

■ n8-84: Polarity Detection Current

No. (Hex.)	Name	Description	Default (Range)
n8-84 (02D3) Expert	Polarity Detection Current	<div style="display: flex; justify-content: space-between; font-size: 0.8em;"> V/f CL-V/f OLV CLV AOLV OLV/PM AOLV/PM CLV/PM EZOLV </div> <p>Sets the current for processing an estimation of the initial motor magnetic pole as a percentage, where <i>E5-03 [PM Motor Rated Current]</i> is the 100% value.</p>	100% (0 - 150%)

WARNING! Sudden Movement Hazard. Make sure that the polarity is correct before you send a Run command. If the drive incorrectly detects the polarity, the drive can rotate in the direction opposite of the Run command and cause serious injury or death.

If you use a Yaskawa motor and the motor nameplate has an "Si" item, set this parameter to a value equal to or more than "Si x 2". Consult the motor manufacturer to determine the maximum setting values.

Find the Polarity of Magnetic Poles

At start, the drive estimates the magnetic poles and finds the polarity of the magnetic poles. When $A1-02 = 7$ [*Control Method Selection = CLV/PM*], the drive finds the polarity of the magnetic poles only at the first startup.

Check monitor $U6-57$ [*PolePolarityDeterVal*] to make sure that the drive correctly estimated the polarity of the magnetic poles.

The drive automatically calculates $n8-84$ when High Frequency Injection Auto-Tuning completes successfully.

■ n8-94: Flux Position Estimation Method

No. (Hex.)	Name	Description	Default (Range)
n8-94 (012D) Expert	Flux Position Estimation Method	<div style="display: flex; justify-content: space-between; font-size: 0.8em;"> V/f CL-V/f OLV CLV AOLV OLV/PM AOLV/PM CLV/PM EZOLV </div> <p>Sets the criteria that the drive uses to find changes in speed or load. Usually it is not necessary to change this setting.</p>	Determined by d5-01 (0, 1)

0 : Softstarter

1 : Speed Feedback

Set $n8-57 = 1$ [*HFI Overlap Selection = Enabled*] to enable this parameter. Increases the stability when the speed or load suddenly change, for example with rapid acceleration/deceleration or impact loads.

■ n8-95: Flux Position Est Filter Time

No. (Hex.)	Name	Description	Default (Range)
n8-95 (012E) Expert	Flux Position Est Filter Time	<div style="display: flex; justify-content: space-between; font-size: 0.8em;"> V/f CL-V/f OLV CLV AOLV OLV/PM AOLV/PM CLV/PM EZOLV </div> <p>Sets the time constant of the filter used for the recognition criteria value for speed and load changes. Usually it is not necessary to change this setting.</p>	30 ms (0 - 100 ms)

Note:

Enabled when $n8-94 = 1$ [*Flux Position Estimation Method = Speed Feedback*].

12.11 o: Keypad-Related Settings

o parameters set keypad functions.

Note:

You cannot set these parameters with the optional LED keypad.

Table 12.72 Parameters You Cannot Set with the LED Keypad

No.	Name	No.	Name
o1-05	LCD Contrast Adjustment	o3-04	Select Backup/Restore Location
o1-24 to o1-35:	Custom Monitor 1 to 12	o3-05	Select Items to Backup/Restore
o1-36	LCD Backlight Brightness	o3-06	Auto Parameter Backup Selection
o1-37	LCD Backlight ON/OFF Selection	o3-07	Auto Parameter Backup Interval
o1-38	LCD Backlight Off-Delay	o4-22	Time Format
o1-39	Show Initial Setup Screen	o4-23	Date Format
o1-40	Home Screen Display Selection	o4-24	bAT Detection Selection
o1-41 to o1-46:	1st to 3rd Monitor Area Selections/Settings	o5-01	Log Start/Stop Selection
o1-47 to o1-51:	Trend Plot 1 or 2 Scale Settings	o5-02	Log Sampling Interval
o1-55 to o1-56:	Analog Gauge Area Selection/Setting	o5-03 to o5-12:	Log Monitor Data 1 to 10
o2-27	bCE Detection Selection		

◆ o1: Keypad Display Selection

o1 parameters select the parameters shown on the initial keypad screen and to configure the parameter setting units and display units. These parameters also adjust the backlight and contrast of the LCD display.

■ Home Screen Display Format

o1-40 [Home Screen Display Selection] changes the display of the monitor shown on the Home screen. You can show numerical values or one of these three displays on the Home screen monitor:

Bar Graph Display

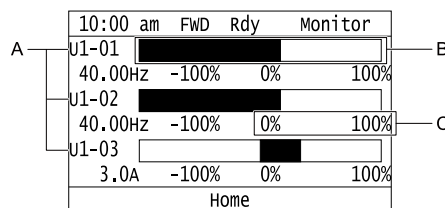

- A - Select *Ux-xx* [Monitors] with *o1-24*, *o1-25*, and *o1-26*.** **C - Select display ranges with *o1-42*, *o1-44*, and *o1-46*.**
B - Configure display regions with *o1-41*, *o1-43*, and *o1-45*.

Analog Gauge Display

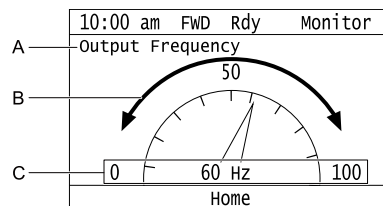

- A - Select *Ux-xx* [Monitors] with *o1-24*.** **C - Select display ranges with *o1-55*.**
B - Configure display regions with *o1-56*.

Trend Plot Display

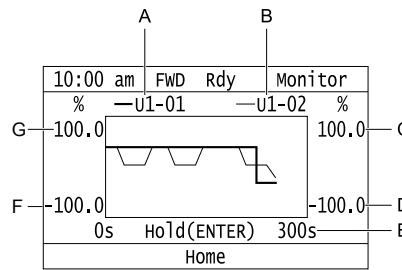

- A - Select *Ux-xx* [Monitors] (Monitor 1) with *o1-24*.**
- B - Select *Ux-xx* [Monitors] (Monitor 2) with *o1-25*.**
- C - Set the maximum value of Monitor 2 with *o1-50***
- D - Set the minimum value of Monitor 2 with *o1-49***
- E - Set the time scale with *o1-51***
- F - Set the minimum value of Monitor 1 with *o1-47***
- G - Set the maximum value of Monitor 1 with *o1-48***

o1-01: User Monitor Selection

No. (Hex.)	Name	Description	Default (Range)
o1-01 (0500) RUN	User Monitor Selection	<div style="display: flex; justify-content: space-between; font-size: small;"> V/f CL-V/f OLV CLV AOLV OLV/PM AOLV/PM CLV/PM EZOLV </div> <p>Sets the <i>U monitor</i> for the Drive Mode. This parameter is only available when you use an LED keypad.</p>	106 (104 - 855)

When the drive is in Drive Mode, push on the keypad to cycle through this data: frequency reference → rotational direction → output frequency → output current → *o1-01* selection.

Set the *x-xx* part of *Ux-xx* that is shown in the fifth position in Drive Mode. For example, to show *U1-05* [Motor Speed], set *o1-01* = 105.

Note:

The monitors that you can select are different for different control methods.

o1-02: Monitor Selection at Power-up

No. (Hex.)	Name	Description	Default (Range)
o1-02 (0501) RUN	Monitor Selection at Power-up	<div style="display: flex; justify-content: space-between; font-size: small;"> V/f CL-V/f OLV CLV AOLV OLV/PM AOLV/PM CLV/PM EZOLV </div> <p>Sets the monitor item that the keypad screen shows after energizing the drive. Refer to "U: Monitors" for information about the monitor items that the keypad screen can show. This parameter is only available when you use an LED keypad.</p>	1 (1 - 5)

1 : Frequency Reference (U1-01)

2 : Direction

3 : Output Frequency (U1-02)

4 : Output Current (U1-03)

5 : User Monitor (o1-01)

Shows the monitor item selected in *o1-01* [User Monitor Selection].

o1-03: Frequency Display Unit Selection

No. (Hex.)	Name	Description	Default (Range)
o1-03 (0502)	Frequency Display Unit Selection	<div style="display: flex; justify-content: space-between; font-size: small;"> V/f CL-V/f OLV CLV AOLV OLV/PM AOLV/PM CLV/PM EZOLV </div> <p>Sets the display units for the frequency reference and output frequency.</p>	Determined by A1-02 (0 - 3)

Note:

- Select the units for these parameters:
 - d1-01 to d1-17 [Reference 1 to 17]
 - U1-01 [Frequency Reference]
 - U1-02 [Output Frequency]
 - U1-05 [Motor Speed]
 - U1-16 [SFS Output Frequency]
 - U4-14 [PeakHold Output Freq]
 - U6-27 [FeedFwd Estimate Spd]
- For motor 2, the settings are always 0 [in Hz unit].

0 : 0.01Hz units**1 : 0.01% units**

The maximum output frequency is 100%.

2 : min⁻¹ (r/min) unit

The drive uses the maximum output frequency and number of motor poles calculate this value automatically.

Note:

When you set $o1-03 = 2$ [r/min], make sure that you set the number of motor poles in these parameters:

- E2-04 [Motor Pole Count]
- E4-04 [Motor 2 Motor Poles]
- E5-04 [PM Motor Pole Count]
- E9-08 [Number of Poles]

3 : User Units

Uses $o1-10$ and $o1-11$ to set the unit of measure. The value of parameter $o1-10$ is the value when you remove the decimal point from the maximum output frequency. Parameter $o1-11$ is to the number of digits after the decimal point in the maximum output frequency.

To display a maximum output frequency of 100.00, set parameters to these values:

- $o1-10 = 10000$
- $o1-11 = 2$ [User Units Decimal Position = 2 Dec (XXX.XX)]

■ o1-04: V/f Pattern Display Unit

No. (Hex.)	Name	Description	Default (Range)
o1-04 (0503)	V/f Pattern Display Unit	<div style="display: flex; gap: 5px;"> V/f CL-V/f OLV CLV AOLV OLV/PM AOLV/PM CLV/PM EZOLV </div> Sets the setting unit for parameters that set the V/f pattern frequency.	Determined by A1-02 (0, 1)

Note:

- Select the units for these parameters:
 - E1-04 [Maximum Output Frequency]
 - E1-06 [Base Frequency]
 - E1-07 [Mid Point A Frequency]
 - E1-09 [Minimum Output Frequency]
 - E1-11 [Mid Point B Frequency]
 - E9-02 [Maximum Speed]
 - E9-04 [Base Frequency]
- For motor 2, the settings are always 0 [in Hz unit].

0 : Hz**1 : min⁻¹ (r/min) unit**

When you set $o1-04 = 1$ [min⁻¹(r/min) unit], you must also use these parameters to set the motor pole count:

- E2-04 [Motor Pole Count]
- E5-04 [PM Motor Pole Count]
- E9-08 [Motor Pole Count]

■ **o1-05: LCD Contrast Adjustment**

No. (Hex.)	Name	Description	Default (Range)
o1-05 (0504) RUN	LCD Contrast Adjustment	<div style="display: flex; justify-content: space-between; font-size: 0.8em; font-weight: bold;"> V/f CL-V/f OLV CLV AOLV OLV/PM AOLV/PM CLV/PM EZOLV </div> <p>Sets the contrast of the LCD display on the keypad.</p>	5 (0 - 10)

When you decrease the setting value, the contrast of the LCD display decreases. When you increase the setting value, the contrast increases.

■ **o1-10: User Units Maximum Value**

No. (Hex.)	Name	Description	Default (Range)
o1-10 (0520)	User Units Maximum Value	<div style="display: flex; justify-content: space-between; font-size: 0.8em; font-weight: bold;"> V/f CL-V/f OLV CLV AOLV OLV/PM AOLV/PM CLV/PM EZOLV </div> <p>Sets the value that the drive shows as the maximum output frequency.</p>	Determined by o1-03 (1 - 60000)

To display a maximum output frequency of 100.00, set parameters to these values:

- o1-10 = 10000
- o1-11 = 2 [User Units Decimal Position = 2 Dec (XXX.XX)]

Note:

Set o1-03 = 3 [Frequency Display Unit Selection = User Units (o1-10 & o1-11)] before you set o1-10 and o1-11.

■ **o1-11: User Units Decimal Position**

No. (Hex.)	Name	Description	Default (Range)
o1-11 (0521)	User Units Decimal Position	<div style="display: flex; justify-content: space-between; font-size: 0.8em; font-weight: bold;"> V/f CL-V/f OLV CLV AOLV OLV/PM AOLV/PM CLV/PM EZOLV </div> <p>Sets the number of decimal places for frequency reference and monitor values.</p>	Determined by o1-03 (0 - 3)

0 : No Decimal Places (XXXXX)

1 : One Decimal Places (XXXX.X)

2 : Two Decimal Places (XXX.XX)

3 : Three Decimal Places (XX.XXX)

Note:

Set o1-03 = 3 [Frequency Display Unit Selection = User Units (o1-10 & o1-11)] before you set o1-10 [User Units Maximum Value] and o1-11.

■ **o1-24 to o1-35: Custom Monitor 1 to 12**









No. (Hex.)	Name	Description	Default (Range)
o1-24 to o1-35: (11AD - 11B8) RUN	Custom Monitor 1 to 12	<div style="display: flex; justify-content: space-between; font-size: 0.8em; font-weight: bold;"> V/f CL-V/f OLV CLV AOLV OLV/PM AOLV/PM CLV/PM EZOLV </div> <p>Sets a maximum of 12 monitors as user monitors. This parameter is only available when using an LCD keypad.</p>	o1-24: 101 o1-25: 102 o1-26: 103 o1-27 to o1-35: 0 (0, 101 - 999)

These parameters save the monitor items selected by the LCD keypad [Custom Monitor].

Note:









- You can show a maximum of three selected monitors on one LCD keypad screen.
 - When you select only one monitor, the text size of this monitor increases. For example, when $o1-25$ to $o1-35 = 0$, the text size of the monitor saved in $o1-24$ increases.
 - When you select two monitors, the text size of these monitors increase.
 - When you select four or more monitors, the fourth monitor and all additional monitors are shown on the next screens.
- Monitors selected with $o1-24$ to $o1-26$ can be displayed as a bar graph, analog gauge, or trend plot.
 - Bar graph display: 3 monitors maximum
Select with $o1-24$, $o1-25$, and $o1-26$.
 - Analog gauge display: 1 monitor
Select with $o1-24$.
 - Trend plot display: 2 monitors
Select with $o1-24$ and $o1-25$.
- You can only set parameters $o1-24$ to $o1-26$ with analog output monitors.
- $o1-27$ to $o1-35$ let you to select all the monitors.

■ o1-36: LCD Backlight Brightness

No. (Hex.)	Name	Description	Default (Range)
o1-36 (11B9) RUN	LCD Backlight Brightness	         Sets the intensity of the LCD keypad backlight.	5 (1 - 5)

When you decrease the setting value, the intensity of the backlight decreases.

■ o1-37: LCD Backlight ON/OFF Selection

No. (Hex.)	Name	Description	Default (Range)
o1-37 (11BA) RUN	LCD Backlight ON/OFF Selection	         Sets the automatic shut off function for the LCD backlight.	0 (0, 1)

Note:



Use $o1-36$ [LCD backlight adjustment] to adjust the intensity of the LCD backlight.

0 : OFF**1 : ON**









Enables the automatic shut off function. The backlight will automatically turn off after the time set in $o1-38$ [Time to turn off LCD backlight] is expired.

Note:

When $o1-37 = 1$ and the backlight is OFF, the keys other than  are disabled.

When the backlight is off, push a key on the keypad to temporarily turn the backlight on. Push any key to start keypad operation, Push  to turn the backlight on, then push  again to enter a Run command to the drive.

■ o1-38: LCD Backlight Off-Delay

No. (Hex.)	Name	Description	Default (Range)
o1-38 (11BB) RUN	LCD Backlight Off-Delay	         Sets the time until the LCD backlight automatically turns off.	60 s (10 - 300 s)

When $o1-37 = 1$ [LCD backlight ON/OFF Selection = ON], the backlight will automatically turn off after the time set in $o1-38$ expires.

When the backlight is off, push a key on the keypad to temporarily turn the backlight on. After the backlight turns on, it will turn off automatically after the time set in $o1-38$ is expired.

■ o1-39: Show Initial Setup Screen

No. (Hex.)	Name	Description	Default (Range)
o1-39 (11BC) RUN	Show Initial Setup Screen	<div style="display: flex; justify-content: space-between; font-size: 0.8em; font-weight: bold;"> V/f CL-V/f OLV CLV AOLV OLV/PM AOLV/PM CLV/PM EZOLV </div> <p>Sets the function to show the LCD keypad initial setup screen each time the drive is energized. This parameter is only available when using an LCD keypad.</p>	1 (0, 1)

The initial setup screen shows a menu where you can select the display language, set the date, time, and other basic settings. When you set this parameter to 0, the drive will not show this screen each time you energize the drive.

0 : No

The drive will not show the initial setup display screen each time you energize the drive. The drive will show the Home screen.

1 : Yes

When you input the Run command before you energize the drive or when you turn on the Run command while the drive shows the initial setup screen, the drive will replace the initial setup screen with the Home screen.

■ o1-40: Home Screen Display Selection

No. (Hex.)	Name	Description	Default (Range)
o1-40 (11BD) RUN	Home Screen Display Selection	<div style="display: flex; justify-content: space-between; font-size: 0.8em; font-weight: bold;"> V/f CL-V/f OLV CLV AOLV OLV/PM AOLV/PM CLV/PM EZOLV </div> <p>Sets the monitor display mode for the Home screen. This parameter is only available when using an LCD keypad.</p>	0 (0 - 3)

0 : Custom Monitor

1 : Bar Graph

2 : Analog Gauge

3 : Trend Plot

■ o1-41: 1st Monitor Area Selection

No. (Hex.)	Name	Description	Default (Range)
o1-41 (11C1) RUN	1st Monitor Area Selection	<div style="display: flex; justify-content: space-between; font-size: 0.8em; font-weight: bold;"> V/f CL-V/f OLV CLV AOLV OLV/PM AOLV/PM CLV/PM EZOLV </div> <p>Sets the horizontal range used to display the monitor set in o1-24 [Custom Monitor 1] as a bar graph. This parameter is only available when using an LCD keypad.</p>	0 (0 - 2)

0 : +/- Area (- o1-42 ~ o1-42)

1 : + Area (0 ~ o1-42)

2 : - Area (- o1-42 ~ 0)

■ o1-42: 1st Monitor Area Setting

No. (Hex.)	Name	Description	Default (Range)
o1-42 (11C2) RUN	1st Monitor Area Setting	<div style="display: flex; justify-content: space-between; font-size: 0.8em; font-weight: bold;"> V/f CL-V/f OLV CLV AOLV OLV/PM AOLV/PM CLV/PM EZOLV </div> <p>Sets the horizontal axis value used to display the monitor set in o1-24 [Custom Monitor 1] as a bar graph. This parameter is only available when using an LCD keypad.</p>	100.0% (0.0 - 100.0%)

■ o1-43: 2nd Monitor Area Selection

No. (Hex.)	Name	Description	Default (Range)
o1-43 (11C3) RUN	2nd Monitor Area Selection	<div style="display: flex; justify-content: space-between; font-size: 0.8em; font-weight: bold;"> V/f CL-V/f OLV CLV AOLV OLV/PM AOLV/PM CLV/PM EZOLV </div> <p>Selects the horizontal range used to display the monitor set in o1-25 [Custom Monitor 2] as a bar graph. This parameter is only available when using an LCD keypad.</p>	0 (0 - 2)

0 : +/- Area (- o1-44 ~ o1-44)

1 : + Area (0 ~ o1-44)

2 : - Area (- o1-44 ~ 0)

■ o1-44: 2nd Monitor Area Setting

No. (Hex.)	Name	Description	Default (Range)
o1-44 (11C4) RUN	2nd Monitor Area Setting	V/f CL-V/f OLV CLV AOLV OLV/PM AOLV/PM CLV/PM EZOLV Sets the horizontal axis value used to display the monitor set in o1-25 [Custom Monitor 2] as a bar graph. This parameter is only available when using an LCD keypad.	100.0% (0.0 - 100.0%)

■ o1-45: 3rd Monitor Area Selection

No. (Hex.)	Name	Description	Default (Range)
o1-45 (11C5) RUN	3rd Monitor Area Selection	V/f CL-V/f OLV CLV AOLV OLV/PM AOLV/PM CLV/PM EZOLV Sets the horizontal range used to display the monitor set in o1-26 [Custom Monitor 3] as a bar graph. This parameter is only available when using an LCD keypad.	0 (0 - 2)

0 : +/- Area (- o1-46 ~ o1-46)

1 : + Area (0 ~ o1-46)

2 : - Area (- o1-46 ~ 0)

■ o1-46: 3rd Monitor Area Setting

No. (Hex.)	Name	Description	Default (Range)
o1-46 (11C6) RUN	3rd Monitor Area Setting	V/f CL-V/f OLV CLV AOLV OLV/PM AOLV/PM CLV/PM EZOLV Sets the horizontal axis value used to display the monitor set in o1-26 [Custom Monitor 3] as a bar graph. This parameter is only available when using an LCD keypad.	100.0% (0.0 - 100.0%)

■ o1-47: Trend Plot 1 Scale Minimum Value

No. (Hex.)	Name	Description	Default (Range)
o1-47 (11C7) RUN	Trend Plot 1 Scale Minimum Value	V/f CL-V/f OLV CLV AOLV OLV/PM AOLV/PM CLV/PM EZOLV Sets the horizontal axis minimum value used to display the monitor set in o1-24 [Custom Monitor 1] as a trend plot. This parameter is only available when using an LCD keypad.	-100.0% (-300.0 - +300.0%)

■ o1-48: Trend Plot 1 Scale Maximum Value

No. (Hex.)	Name	Description	Default (Range)
o1-48 (11C8) RUN	Trend Plot 1 Scale Maximum Value	V/f CL-V/f OLV CLV AOLV OLV/PM AOLV/PM CLV/PM EZOLV Sets the horizontal axis maximum value used to display the monitor set in o1-25 [Custom Monitor 1] as a trend plot. This parameter is only available when using an LCD keypad.	100.0% (-300.0 - +300.0%)

■ o1-49: Trend Plot 2 Scale Minimum Value

No. (Hex.)	Name	Description	Default (Range)
o1-49 (11C9) RUN	Trend Plot 2 Scale Minimum Value	V/f CL-V/f OLV CLV AOLV OLV/PM AOLV/PM CLV/PM EZOLV Sets the horizontal axis minimum value used to display the monitor set in o1-25 [Custom Monitor 2] as a trend plot. This parameter is only available when using an LCD keypad.	-100.0% (-300.0 - +300.0%)

■ o1-50: Trend Plot 2 Scale Maximum Value

No. (Hex.)	Name	Description	Default (Range)
o1-50 (11CA) RUN	Trend Plot 2 Scale Maximum Value	V/f CL-V/f OLV CLV AOLV OLV/PM AOLV/PM CLV/PM EZOLV Sets the horizontal axis maximum value used to display the monitor set in o1-25 [Custom Monitor 2] as a trend plot. This parameter is only available when using an LCD keypad.	100.0% (-300.0 - +300.0%)

■ o1-51: Trend Plot Time Scale Setting

No. (Hex.)	Name	Description	Default (Range)
o1-51 (11CB) RUN	Trend Plot Time Scale Setting	<div style="display: flex; justify-content: space-between; font-size: 0.8em; font-weight: bold;"> V/f CL-V/f OLV CLV AOLV OLV/PM AOLV/PM CLV/PM EZOLV </div> <p>Sets the time scale (horizontal axis) to display the trend plot. When you change this setting, the drive automatically adjusts the data sampling time. This parameter is only available when using an LCD keypad.</p>	300 s (1 - 3600 s)

■ o1-55: Analog Gauge Area Selection

No. (Hex.)	Name	Description	Default (Range)
o1-55 (11EE) RUN	Analog Gauge Area Selection	<div style="display: flex; justify-content: space-between; font-size: 0.8em; font-weight: bold;"> V/f CL-V/f OLV CLV AOLV OLV/PM AOLV/PM CLV/PM EZOLV </div> <p>Sets the range used to display the monitor set in o1-24 [Custom Monitor 1] as an analog gauge. This parameter is only available when using an LCD keypad.</p>	1 (0, 1)

0 : +/- Area (- o1-56 ~ o1-56)

1 : + Area (0 ~ o1-56)

■ o1-56: Analog Gauge Area Setting

No. (Hex.)	Name	Description	Default (Range)
o1-56 (11EF) RUN	Analog Gauge Area Setting	<div style="display: flex; justify-content: space-between; font-size: 0.8em; font-weight: bold;"> V/f CL-V/f OLV CLV AOLV OLV/PM AOLV/PM CLV/PM EZOLV </div> <p>Sets the value used to display the monitor set in o1-24 [Custom Monitor 1] as an analog meter. This parameter is only available when using an LCD keypad.</p>	100.0% (0.0 - 100.0%)

■ o1-58: Motor Power Unit Selection

No. (Hex.)	Name	Description	Default (Range)
o1-58 (3125)	Motor Power Unit Selection	<div style="display: flex; justify-content: space-between; font-size: 0.8em; font-weight: bold;"> V/f CL-V/f OLV CLV AOLV OLV/PM AOLV/PM CLV/PM EZOLV </div> <p>Sets the setting unit for parameters that set the motor rated power.</p>	1 (0, 1)

The drive shows these parameter values in the set units:

- E2-11 [Motor Rated Power]
- E4-11 [Motor 2 Rated Power]
- E5-02 [PM Motor Rated Power]
- E9-07 [Motor Rated Power]
- T1-02 [Motor Rated Power]
- T2-04 [PM Motor Rated Power]
- T4-08 [Motor Rated Capacity]

0 : kW

Shows the motor output in kW units.

1 : HP

Shows the motor output in HP units.

◆ o2: Keypad Operation

■ o2-01: LO/RE Key Function Selection

No. (Hex.)	Name	Description	Default (Range)
o2-01 (0505)	LO/RE Key Function Selection	<div style="display: flex; justify-content: space-between; font-size: 0.8em; font-weight: bold;"> V/f CL-V/f OLV CLV AOLV OLV/PM AOLV/PM CLV/PM EZOLV </div> <p>Sets the function that lets you use LO/RE to switch between LOCAL and REMOTE Modes.</p>	1 (0, 1)

0 : Disabled

You cannot use  to switch between LOCAL and REMOTE Modes.

1 : Enabled

You can use  to switch between LOCAL and REMOTE Modes when the drive is stopped. When LOCAL Mode is selected,  on the keypad will come on.











WARNING! Sudden Movement Hazard. If you change the control source when $b1-07 = 1$ [LOCAL/REMOTE Run Selection = Accept Existing RUN Command], the drive can start suddenly. Before you change the control source, remove all personnel from the area around the drive, motor, and load. Sudden starts can cause serious injury or death.

WARNING! Sudden Movement Hazard. Fully examine all mechanical and electrical connections before you change $o2-01$ [LO/RE Key Function Selection] or $b1-07$ [LOCAL/REMOTE Run Selection]. Sudden starts can cause serious injury or death. If $b1-07 = 1$ [Accept Existing RUN Command] and there is an active Run command when you switch from LOCAL to REMOTE Mode, the drive can start suddenly.

Table 12.73 Function Settings with $o2-01$ and $b1-07$

 Function Selection	LOCAL/REMOTE Run Selection	Switching from LOCAL Mode to REMOTE Mode	Switching from REMOTE Mode to LOCAL Mode
$o2-01 = 0$ [Disabled]	$b1-07 = 0$ [Disregard Existing RUN Command]	The drive will not switch modes.	The drive will not switch modes.
	$b1-07 = 1$ [Accept Existing RUN Command]		
$o2-01 = 1$ [Enabled]	$b1-07 = 0$ [Disregard Existing RUN Command]	The drive will not start operating although the Run command is active. When you set Run command to active again, the drive will start to run.	The drive cannot operate because the Run command is not enabled.
	$b1-07 = 1$ [Accept Existing RUN Command]	When the Run command is active, the drive will start to run immediately when the mode switches from LOCAL to REMOTE.	The drive cannot operate because the Run command is not enabled.

■ $o2-02$: STOP Key Function Selection

No. (Hex.)	Name	Description	Default (Setting Range)
$o2-02$ (0506)	STOP Key Function Selection	         Sets the function to use  on the keypad to stop the drive when the Run command source for the drive is REMOTE (external) and not assigned to the keypad.	1 (0, 1)









0 : Disabled

1 : Enabled

 stays enabled when the Run command source has not been assigned to the keypad.

To start the drive again after you push  to stop operation, turn the external Run command OFF and ON again.

■ $o2-03$: User Parameter Default Value

No. (Hex.)	Name	Description	Default (Range)
$o2-03$ (0507)	User Parameter Default Value	         Sets the function to keep the settings of changed parameters as user parameter defaults to use during initialization.	0 (0 - 2)

When you set $o2-03 = 1$ [Set defaults], the drive saves changed parameter settings as user parameter setting values in a part of the memory that is isolated from drive parameters.

When you set $A1-03 = 1110$ [Initialize Parameters = User Initialization] to initialize the drive, the drive resets the internal parameter setting values to those user parameter setting values.

0 : No change

1 : Set defaults

Saves changed parameter setting values as user default settings.









Set $o2-03 = 1$ then push  to save the user parameter setting values. After the drive saves the setting value, $o2-03$ automatically resets to 0.

2 : Clear all

Deletes all of the saved user parameter setting values.

Set *o2-03* = 2 then push  to clear the user parameter setting values. The drive will automatically reset *o2-03* to 0. If you delete the user parameter setting values, you cannot set *A1-03* = 1110 to initialize parameters.

■ o2-04: Drive Model (KVA) Selection

No. (Hex.)	Name	Description	Default (Range)
o2-04 (0508)	Drive Model (KVA) Selection	         Sets the Drive Model code. Set this parameter after replacing the control board.	Determined by the drive (-)

NOTICE: Set *o2-04* [Drive Model Selection] correctly. If you set this parameter incorrectly, it will decrease drive performance, cause the protection function to operate incorrectly, and cause damage to the drive.

Note:

When the setting value of *o2-04* changes, related parameter setting values also change. Refer to [Defaults by Drive Model and Duty Rating ND/HD on page 598](#) for more information.

These tables list the relation between *o2-04* setting values and drive models.

o2-04 Setting	Drive Model
62	2004
63	2006
64	2008
65	2010
66	2012
67	2018
68	2021
6A	2030
6B	2042
6D	2056
6E	2070
6F	2082
70	2110
72	2138
73	2169
74	2211
75	2257
76	2313
77	2360
78	2415
92	4002
93	4004
94	4005

o2-04 Setting	Drive Model
95	4007
96	4009
97	4012
99	4018
9A	4023
9C	4031
9D	4038
9E	4044
9F	4060
A1	4075
A2	4089
A3	4103
A4	4140
A5	4168
A6	4208
A7	4250
A8	4302
A9	4371
AA	4414
AC	4477
AD	4568
AE	4605
AF	4720



■ o2-05: Home Mode Freq Ref Entry Mode

No. (Hex.)	Name	Description	Default (Setting Range)
o2-05 (0509)	Home Mode Freq Ref Entry Mode	<div style="display: flex; justify-content: space-between; font-size: 0.8em; font-weight: bold;"> V/f CL-V/f OLV CLV AOLV OLV/PM AOLV/PM CLV/PM EZOLV </div> <p>Sets the function that makes it necessary to push  to use the keypad to change the frequency reference value while in Drive Mode.</p>	0 (0, 1)

0 : ENTER Key Required

You must push  to use the keypad to change the frequency reference value.

1 : Immediate / MOP-style

The frequency reference changes when you enter it with the keypad. This then changes the output frequency. It is not necessary to push . The drive keeps the frequency reference for 5 seconds after you use  and  on the keypad to change the frequency reference value.

■ o2-06: Keypad Disconnect Detection

No. (Hex.)	Name	Description	Default (Range)
o2-06 (050A)	Keypad Disconnect Detection	<div style="display: flex; justify-content: space-between; font-size: 0.8em; font-weight: bold;"> V/f CL-V/f OLV CLV AOLV OLV/PM AOLV/PM CLV/PM EZOLV </div> <p>Sets the function that stops the drive if you disconnect the keypad connection cable from the drive or if you damage the cable while the keypad is the Run command source.</p>	1 (0, 1)

This parameter continues to operate if the keypad installed to the drive becomes disconnected.

This parameter is enabled in these conditions:

- When $b1-02 = 0$ [Run Command Selection 1 = Keypad] or $b1-16 = 0$ [Run Command Selection 2 = Keypad]
- In LOCAL Mode

0 : Disabled

The drive continues operation when it detects a keypad disconnection.

1 : Enabled

The drive stops operation, detects oPr [Keypad Connection Fault], and the motor coasts to stop when the drive detects a keypad disconnection.

■ o2-07: Keypad RUN Direction @ Power-up

No. (Hex.)	Name	Description	Default (Range)
o2-07 (0527)	Keypad RUN Direction @ Power-up	<div style="display: flex; justify-content: space-between; font-size: 0.8em; font-weight: bold;"> V/f CL-V/f OLV CLV AOLV OLV/PM AOLV/PM CLV/PM EZOLV </div> <p>Sets the direction of motor rotation when the drive is energized and the keypad is the Run command source.</p>	0 (0, 1)

This parameter is enabled in these conditions:

- When $b1-02 = 0$ [Run Command Selection 1 = Keypad] or $b1-16 = 0$ [Run Command Selection 2 = Keypad]
- In LOCAL Mode

0 : Forward

1 : Reverse

■ o2-09: Region Code

No. (Hex.)	Name	Description	Default (Range)
o2-09 (050D)	Reserved	-	-

■ **o2-23: External 24V Powerloss Detection**

No. (Hex.)	Name	Description	Default (Setting Range)
o2-23 (11F8) RUN	External 24V Powerloss Detection	<div style="display: flex; justify-content: space-between; font-size: 0.8em; font-weight: bold; background-color: #f0f0f0; padding: 2px;"> V/f CL-V/f OLV CLV AOLV OLV/PM AOLV/PM CLV/PM EZOLV </div> <p>Sets the function to give a warning if the backup external 24 V power supply turns off when the main circuit power supply is in operation.</p>	0 (0, 1)

Note:

The drive will not run when it is operating from one 24-V external power supply.

0 : Disabled

The drive does not detect the loss of the 24-V external power supply.

1 : Enabled

The keypad shows the *L24v [Loss of External Power 24 Supply]* indicator when the drive detects the loss of the 24-V external power supply.

Note:

H2-xx = 10 [MFDO Function Selection = Minor Fault] will not output a minor fault signal.

■ **o2-24: LED Light Function Selection**

No. (Hex.)	Name	Description	Default (Range)
o2-24 (11FE)	LED Light Function Selection	<div style="display: flex; justify-content: space-between; font-size: 0.8em; font-weight: bold; background-color: #f0f0f0; padding: 2px;"> V/f CL-V/f OLV CLV AOLV OLV/PM AOLV/PM CLV/PM EZOLV </div> <p>Sets the function to show the LED status rings and keypad LED lamps.</p>	2 (0 - 2)

Note:

When you use *A1-03 [Initialize Parameters]* to initialize the drive, the drive will not reset this parameter.

0 : Enable Status Ring & Keypad LED

1 : LED Status Ring Disable

2 : Keypad LED Light Disable

■ **o2-26: Alarm display at ext. 24V power**

No. (Hex.)	Name	Description	Default (Range)
o2-26 (1563)	Alarm display at ext. 24V power	<div style="display: flex; justify-content: space-between; font-size: 0.8em; font-weight: bold; background-color: #f0f0f0; padding: 2px;"> V/f CL-V/f OLV CLV AOLV OLV/PM AOLV/PM CLV/PM EZOLV </div> <p>When you connect a backup external 24 V power supply, this parameter sets the function to trigger an alarm when the main circuit power supply voltage decreases.</p>	1 (0, 1)

0 : Disabled

The drive will not detect *EP24v [External Power 24V Supply]* if the main circuit power supply voltage decreases. The [Ready] light on the LED Status Ring flashes quickly to identify that drive operation is not possible.

1 : Enabled

The drive detects *EP24v* when the main circuit power supply voltage decreases.

Note:

The minor fault signal is not output from *H2-xx = 10 [MFDO Function Selection = Alarm]*.

■ **o2-27: bCE Detection Selection**

No. (Hex.)	Name	Description	Default (Range)
o2-27 (1565)	bCE Detection Selection	<div style="display: flex; justify-content: space-between; font-size: 0.8em; font-weight: bold; background-color: #f0f0f0; padding: 2px;"> V/f CL-V/f OLV CLV AOLV OLV/PM AOLV/PM CLV/PM EZOLV </div> <p>Sets drive operation if the Bluetooth device is disconnected when you operate the drive in Bluetooth Mode.</p>	3 (0 - 4)

0 : Ramp to Stop

1 : Coast to Stop

2 : Fast Stop (Use C1-09)

3 : Alarm Only**4 : No Alarm Display****◆ o3: Copy Function**

o3 parameters set the operation of the parameter backup function.

■ o3-01: Copy Keypad Function Selection

No. (Hex.)	Name	Description	Default (Range)
o3-01 (0515)	Copy Keypad Function Selection	V/f CL-V/f OLV CLV AOLV OLV/PM AOLV/PM CLV/PM EZOLV Sets the function that saves and copies drive parameters to a different drive with the keypad.	0 (0 - 4)

0 : Copy Select**1 : Backup (drive → keypad)**

The parameter setting values are read from the drive and saved in the keypad.

2 : Restore (keypad → drive)

Copies the parameter setting values saved in the keypad to a different drive.

3 : Verify (check for mismatch)

Makes sure that the parameter setting values in the drive agree with the parameters saved in the keypad.

4 : Erase (backup data of keypad)

Deletes the parameter setting values saved in the keypad.

■ o3-02: Copy Allowed Selection

No. (Hex.)	Name	Description	Default (Range)
o3-02 (0516)	Copy Allowed Selection	V/f CL-V/f OLV CLV AOLV OLV/PM AOLV/PM CLV/PM EZOLV Sets the copy function when <i>o3-01</i> = 1 [<i>Copy Keypad Function Selection</i> = Backup (drive → keypad)].	0 (0, 1)

Note:

When you select [Parameter Backup] on the keypad menu screen to do the backup function, the drive automatically sets *o3-02* = 1.

0 : Disabled**1 : Enabled****■ o3-04: Select Backup/Restore Location**

No. (Hex.)	Name	Description	Default (Range)
o3-04 (0B3E)	Select Backup/Restore Location	V/f CL-V/f OLV CLV AOLV OLV/PM AOLV/PM CLV/PM EZOLV Sets the storage location for drive parameters when you back up and restore parameters. This parameter is only available when using an LCD keypad.	0 (0 - 3)

You can use the LCD keypad to make a maximum of 4 parameter backup sets.

0 : Memory Location 1**1 : Memory Location 2****2 : Memory Location 3****3 : Memory Location 4****■ o3-05: Select Items to Backup/Restore**

No. (Hex.)	Name	Description	Default (Range)
o3-05 (0BDA)	Select Items to Backup/Restore	V/f CL-V/f OLV CLV AOLV OLV/PM AOLV/PM CLV/PM EZOLV Sets which parameters are backed up, restored, and referenced. This parameter is only available when using an LCD keypad.	1 (0, 1)

0 : Standard Parameters

1 : Standard + DWEZ Parameters

Note:

- Parameters *qx-xx* [DriveWorksEZ Parameters] and *rx-xx* [DriveWorksEZ Connections] show when *A1-07 = 1 or 2* [DriveWorksEZ Function Selection = DWEZ Enabled or Enabled/Disabled wDigital Input].
- The password for DriveWorksEZ PC software is necessary to back up *qx-xx* and *rx-xx*. If you enter an incorrect password, the drive detects *PWEr* [DWEZ Password Mismatch].

■ o3-06: Auto Parameter Backup Selection

No. (Hex.)	Name	Description	Default (Range)
o3-06 (0BDE)	Auto Parameter Backup Selection	V/f CL-V/f OLV CLV AOLV OLV/PM AOLV/PM CLV/PM EZOLV Sets the function that automatically backs up parameters. This parameter is only available when using an LCD keypad.	1 (0, 1)

When you connect the drive and keypad, parameters set to the drive are automatically backed up to the keypad as specified by the setting of parameters *o3-06* and *o3-07*.

0 : Disabled

1 : Enabled

Note:

When you replace the LCD keypad then energize the drive, the keypad shows the restore operation screen automatically to restore the drive configuration with the parameters backed up to the LCD keypad. If you connect an LCD keypad that does not have parameter backup data, the keypad will not show the restore operation screen.

■ o3-07: Auto Parameter Backup Interval

No. (Hex.)	Name	Description	Default (Range)
o3-07 (0BDF)	Auto Parameter Backup Interval	V/f CL-V/f OLV CLV AOLV OLV/PM AOLV/PM CLV/PM EZOLV Sets the interval at which the automatic parameter backup function saves parameters from the drive to the keypad.	1 (0 - 3)

The drive saves parameter settings to the keypad at these times:

- After you energize the drive and the auto backup period passes.
- When you use ROM enter or the keypad to change parameters, the drive saves those changes in the drive, waits for the auto backup period to pass, then saves those parameters in the keypad.

Note:

The drive can write data to the keypad a maximum of 100,000 times. If you write data to the keypad more than 100,000 times, you must replace the keypad.

0 : Every 10 minutes

1 : Every 30 minutes

2 : Every 60 minutes

3 : Every 12 hours

◆ o4: Maintenance Mon Settings

o4 parameters set the expected service life to help you know when to replace parts. The drive will show an alarm to tell you when the replacement part interval is near.

■ o4-01: Elapsed Operating Time Setting

No. (Hex.)	Name	Description	Default (Range)
o4-01 (050B)	Elapsed Operating Time Setting	V/f CL-V/f OLV CLV AOLV OLV/PM AOLV/PM CLV/PM EZOLV Sets the initial value of the cumulative drive operation time in 10-hour units.	0 h (0 - 9999 h)

When you select *o4-01* on the keypad, it will show the current value of *U4-01* in units of 10 hours (h). When you change the setting of *o4-01* through the monitor, the *U4-01* count starts again as specified by the setting of *o4-01*.

Note:

Set this parameter in 10-hour (h) units. When $o4-01 = 30$, $U4-01$ [Cumulative Ope Time] = 300 h.

■ o4-02: Elapsed Operating Time Selection

No. (Hex.)	Name	Description	Default (Range)
o4-02 (050C)	Elapsed Operating Time Selection	V/f CL-V/f OLV CLV AOLV OLV/PM AOLV/PM CLV/PM EZOLV Sets the condition that counts the cumulative operation time.	0 (0, 1)

0 : U4-01 Shows Total Power-up Time

Counts the time from when the drive is energized to when it is de-energized.

1 : U4-01 Shows Total RUN Time

Counts the time that the drive outputs voltage.

■ o4-03: Fan Operation Time Setting

No. (Hex.)	Name	Description	Default (Range)
o4-03 (050E)	Fan Operation Time Setting	V/f CL-V/f OLV CLV AOLV OLV/PM AOLV/PM CLV/PM EZOLV Sets the value from which to start the cumulative drive cooling fan operation time in 10-hour units.	0 h (0 - 9999 h)

Use monitor $U4-03$ [Cooling Fan Ope Time] to view the total operation time of the cooling fan. When you replace a cooling fan, set $o4-03 = 0$ to reset $U4-03$. Select $o4-03$ on the keypad to show the current value of $U4-03$ in 10-hour (h) units. If you use the monitor to change $o4-03$, the recount of $U4-03$ starts with the $o4-03$ setting.

Note:

The drive sets $o4-03$ in 10-hour (h) units. When $o4-03 = 30$, $U4-03$ [Cooling Fan Ope Time] will show "300 h".

■ o4-05: Capacitor Maintenance Setting

No. (Hex.)	Name	Description	Default (Range)
o4-05 (051D)	Capacitor Maintenance Setting	V/f CL-V/f OLV CLV AOLV OLV/PM AOLV/PM CLV/PM EZOLV Sets the $U4-05$ [CapacitorMaintenance] monitor value.	0% (0 - 150%)

When you replace a drive, set $o4-05 = 0$ to reset $U4-05$. When the $o4-05$ setting changes, the count of $U4-05$ starts again as specified by the setting of $o4-05$. After you complete the configuration, $o4-05$ automatically resets to 0.

Note:

The maintenance period changes for different operating environments.

■ o4-07: Softcharge Relay Maintenance Set

No. (Hex.)	Name	Description	Default (Range)
o4-07 (0523)	Softcharge Relay Maintenance Set	V/f CL-V/f OLV CLV AOLV OLV/PM AOLV/PM CLV/PM EZOLV Sets the $U4-06$ [PreChargeRelayMainte] monitor value.	0% (0 - 150%)

When you replace a drive, set $o4-07 = 0$ to reset $U4-06$. When the $o4-07$ setting changes, the count of $U4-06$ starts again as specified by the setting of $o4-07$. After you complete the configuration, $o4-07$ automatically resets to 0.

Note:

The maintenance period changes for different operating environments.

■ o4-09: IGBT Maintenance Setting

No. (Hex.)	Name	Description	Default (Range)
o4-09 (0525)	IGBT Maintenance Setting	V/f CL-V/f OLV CLV AOLV OLV/PM AOLV/PM CLV/PM EZOLV Sets the $U4-07$ [IGBT Maintenance] monitor value.	0% (0 - 150%)

When you replace a drive, set $o4-09 = 0$ to reset $U4-07$. When the $o4-09$ setting changes, the count of $U4-07$ starts again as specified by the setting of $o4-09$. After you complete the configuration, $o4-09$ automatically resets to 0.

12.11 o: Keypad-Related Settings

Note:

The maintenance period changes for different operating environments.

■ o4-11: Fault Trace/History Init (U2/U3)

No. (Hex.)	Name	Description	Default (Range)
o4-11 (0510)	Fault Trace/History Init (U2/U3)	V/f CL-V/f OLV CLV AOLV OLV/PM AOLV/PM CLV/PM EZOLV Resets the records of Monitors U2-xx [Fault Trace] and U3-xx [Fault History].	0 (0, 1)

Note:

When you initialize the drive with A1-03 [Initialize Parameters], the drive will not reset the records for U2-xx and U3-xx.

0 : Disabled

Keeps the records of Monitors U2-xx and U3-xx.

1 : Enabled

Resets the records for Monitors U2-xx and U3-xx. After the reset, the drive automatically resets o4-11 to 0.

■ o4-12: kWh Monitor Initialization

No. (Hex.)	Name	Description	Default (Range)
o4-12 (0512)	kWh Monitor Initialization	V/f CL-V/f OLV CLV AOLV OLV/PM AOLV/PM CLV/PM EZOLV Resets the monitor values for U4-10 [kWh, Lower 4 Digits] and U4-11 [kWh, Upper 5 Digits].	0 (0, 1)

Note:

When you initialize the drive with A1-03 [Initialize Parameters], the drive will not reset U4-10 and U4-11.

0 : No Reset

Keeps the monitor values for U4-10 and U4-11.

1 : Reset

Resets the values of U4-10 and U4-11. After the reset, the drive automatically resets o4-12 to 0.

■ o4-13: RUN Command Counter @ Initialize

No. (Hex.)	Name	Description	Default (Range)
o4-13 (0528)	RUN Command Counter @ Initialize	V/f CL-V/f OLV CLV AOLV OLV/PM AOLV/PM CLV/PM EZOLV Resets the monitor values for U4-02 [Num of Run Commands], U4-24 [Number of Runs (Low)], and U4-25 [Number of Runs (High)].	0 (0, 1)

0 : No Reset

Keeps the monitor values for U4-02, U4-24, and U4-25.

1 : Reset

Resets the values of U4-02, U4-24, and U4-25. After the reset, the drive automatically resets o4-13 to 0.

■ o4-22: Time Format

No. (Hex.)	Name	Description	Default (Range)
o4-22 (154F) RUN	Time Format	V/f CL-V/f OLV CLV AOLV OLV/PM AOLV/PM CLV/PM EZOLV Sets the time display format. This parameter is only available when using an LCD keypad.	1 (0 - 2)

Sets the display of the time shown in the upper-left of the LCD keypad screen.

0 : 24 Hour Clock

1 : 12 Hour Clock

2 : 12 Hour JP Clock

■ o4-23: Date Format

No. (Hex.)	Name	Description	Default (Range)
o4-23 (1550) RUN	Date Format	<div style="display: flex; justify-content: space-between; font-size: 0.8em; font-weight: bold;"> V/f CL-V/f OLV CLV AOLV OLV/PM AOLV/PM CLV/PM EZOLV </div> Sets the date display format. This parameter is only available when using an LCD keypad.	2 (0 - 2)

Sets the date format that the drive uses for the fault history and other records.

0 : YYYY/MM/DD

1 : DD/MM/YYYY

2 : MM/DD/YYYY

Note:

The Fault History in the Monitor Mode shows when faults occurred. Refer to [Show Fault History on page 173](#) for more information.

■ o4-24: bAT Detection Selection

No. (Hex.)	Name	Description	Default (Range)
o4-24 (310F) RUN	bAT Detection Selection	<div style="display: flex; justify-content: space-between; font-size: 0.8em; font-weight: bold;"> V/f CL-V/f OLV CLV AOLV OLV/PM AOLV/PM CLV/PM EZOLV </div> Sets operation when the drive detects <i>bAT</i> [Keypad Battery Low Voltage] and <i>TiM</i> [Keypad Time Not Set].	0 (0 - 2)

0 : Disable

The drive will not detect *bAT* or *TiM*.

1 : Enable (Alarm Detected)

TiM or *bAT* shows on the keypad, and operation continues. The output terminal set for Alarm [H2-01 to H2-03 = 10] activates.

2 : Enable (Fault Detected)

The drive output shuts off and the motor coasts to stop. Fault relay output terminal MA-MC activates, and MB-MC deactivates.

◆ o5: Log Function

The data log function saves drive status information as a CSV file in the micro SD memory card in the keypad. *Monitors Ux-xx* are the source of data log information. You can record a maximum of 10 monitors.

Change the LCD keypad screen from the main menu to the Diagnostic Tools screen and select the data log function. Set the number of the monitor to record and the sampling time, then start to record the data log.

Table 12.74 Setting Parameters for Data Log Items

No.	Name	Default	Data Log Monitors
o5-03	Log Monitor Data 1	101	U1-01 [Frequency Reference]
o5-04	Log Monitor Data 2	102	U1-02 [Output Frequency]
o5-05	Log Monitor Data 3	103	U1-03 [Output Current]
o5-06	Log Monitor Data 4	107	U1-07 [DC Bus Voltage]
o5-07	Log Monitor Data 5	108	U1-08 [Output Power]
o5-08	Log Monitor Data 6	000	Not selected
o5-09	Log Monitor Data 7	000	Not selected
o5-10	Log Monitor Data 8	000	Not selected
o5-11	Log Monitor Data 9	000	Not selected
o5-12	Log Monitor Data 10	000	Not selected

12.11 o: Keypad-Related Settings

Note:

- Failure to obey can cause the log function to fail after you restore power or connect the keypad. Do not de-energize the drive or disconnect the keypad from the drive during log transfer communication.
- You can use a Micro SDHC card a maximum of 32 GB capacity.

■ Log File Specifications

Item	Specification
File storage location	A folder called [Log_File] is created in the root directory of the micro SD card.
Filename	GLOG0xxx.csv Note: [xxx] identifies a 3-digit decimal number
Maximum number of files	999 (GLOG0001.csv to GLOG0999.csv)
Character code	ASCII code
Line break code	<CR><LF>
Separating character	[,] (Commas)
Header Rows	First Row: Drive information including Drive Model, software version, control method, and sampling time Second Row: Log data information including the monitor number, number decimal points, and unit code

■ Log File Configuration

The [Log_Files] folder is created in the root directory of the micro SD card. This is where the log data is stored as CSV files. Log data files are created in this configuration. The number of rows changes when the number of selected monitors change.

First row	Drive information
Second row	Log data information
Third row	Log data 1
:	Log data 2
:	Log data 3
:	:
Last row	Log data n

First Row: Drive Information

This example shows the data text strings and data generated for the first row of log data.

Example of generated data: 00,0012,160107111230,GA800,VSAA09010,2,62,1000,000001

No.	Item	Number of Characters	Example	Description
1	Attribute	2	00	[00] shows that the record is a drive information record.
2	File number	4	0012	The [xxx] part of the [GLOG0xxx.csv] filename is a 3-digit decimal number in hexadecimal format. Example filename of [GLOG0018.csv]: 018 (Dec.) = 0012 (Hex.)
3	Time stamp ^{*1}	12	160107111230	Date file was generated <ul style="list-style-type: none"> • Date: 20YY/MM/DD • Time in 24-hour format: HH:MM:SS Example data of [160107111230]: 11:12:30 on January 7, 2016
4	Model	5	GA800	Drive model information
5	Software number	9	VSAA09010	Drive software number
6	Control method	1	2	Setting value (Hex.) of A1-02 [Control Method Selection]
7	Drive capacity	2	62	Setting value (Hex.) of o2-04 [Drive Model Selection]
8	Sampling time	5 (maximum)	1000	Setting value (Dec.) of o5-02 [Log Sampling Interval] Unit: ms
9	Row number	6	000001	Row number (Hex.) in the data log file

*1 If you do not set the time in the keypad, the text string of [000000000000] is generated to show the time.

Second Row: Log Data Information

This example shows the data text strings and data generated for the second row of log data.

Example of generated data:

01,0012,160107111230,0101,0201,0102,0201,0103,0206,0107,0005,0108,0209,0000,0000,0000,0000,0000,000,000,0000,0000,0000,0000,0000,0000,0000,0000,0000,000002

No.	Item	Number of Characters	Description
1	Attribute	2	[01] shows that the record is a log data information record.
2	File number	4	The [xxx] part of the [GLOG0xxx.csv] filename is a 3-digit decimal number in hexadecimal format.
3	Time stamp	12	Date file was generated
4	Monitor number 1 *1	4	Monitor number selected by o5-03 [Log Monitor Data 1] Ex.: 0101 (Dec.) for U1-01
5	Monitor number 1 *2	4	Unit code and number of decimal places used for the monitor selected with o5-03 Example when U1-01 = 30.00 Hz: Number of decimal places = 2, Hz unit code = 01, monitor unit 1 = 0201 (Hex.)
6	Monitor number 2	4	Monitor number selected by o5-04 [Log Monitor Data 2]
7	Monitor number 2	4	Unit code and number of decimal places used for the monitor selected with o5-04
:	:	:	:
22	Monitor number 10	4	Monitor number selected by o5-12 [Log Monitor Data 1]
23	Monitor number 10	4	Unit code and number of decimal places used for the monitor selected with o5-12
24 to 27	Reserved	4	-
28	File number	6	Row number (Hex.) in the data log file

*1 If there is no data log monitor selected, the text string of [0000] is generated.

*2 Refer to [Table 12.75](#) for information about unit codes.

Table 12.75 Unit Codes

Unit Code (Hex.)	Unit	Unit Code (Hex.)	Unit	Unit Code (Hex.)	Unit	Unit Code (Hex.)	Unit
00	–	08	PPR	10	H	18	0H
01	Hz	09	kW	11	V	19	–
02	RPM	0A	Ω	12	us	1A	–
03	%	0B	ms	13	min	1B	–
04	VAC	0C	kHz	14	°C	1C	–
05	VDC	0D	PSI	15	W	1D	–
06	A	0E	MPM	16	kWH	1E	–
07	sec	0F	FPM	17	MWH	1F	–

Third and Subsequent Rows: Log Data

This example shows the data text strings and data generated for the third row of log data.

Example of generated data:

02,0012,160107111239,1770,1770,00BE,0118,0028,0000,0000,0000,0000,0000,0000,0000,0000,000000C

No.	Item	Number of Characters	Description
1	Attribute	2	[02] shows that the record is a monitor data record.
2	File number	4	The [xxx] part of the [GLOG0xxx.csv] filename is a 3-digit decimal number in hexadecimal format.
3	Time stamp	12	Data log data was retrieved (YYMMDDHHMMSS)
4	Log Monitor Data 1	4	Monitor number selected by o5-03 [Log Monitor Data 1]
5	Log Monitor Data 2	4	Monitor number selected by o5-04 [Log Monitor Data 2]
:	:	:	:
13	Log Monitor Data 10	4	Monitor number selected by o5-12 [Log Monitor Data 10]

12.11 o: Keypad-Related Settings

No.	Item	Number of Characters	Description
14	Reserved	4	-
15	Encoding data	4	Encoding data for log monitor data 1 through 10 (Hex.) Bits 0 through 9 show the encoding of log monitor data 1 through 10. A bit value of 1 shows that the data represents a negative value. (Log monitor data 1 through 10 is absolute value data without encoding) Example when log monitor data 2, 5, and 8 show negative values: Bits 1, 4, and 7 have values of 1, and the encoding data = 0010010010 (Bin.) = 0092 (Hex.)
16	File number	6	Row number (Hex.) in the data log file

■ o5-01: Log Start/Stop Selection

No. (Hex.)	Name	Description	Default (Range)
o5-01 (1551) RUN	Log Start/Stop Selection	<div style="display: flex; gap: 5px;"> V/f CL-V/f OLV CLV AOLV OLV/PM AOLV/PM CLV/PM EZOLV </div> Sets the data log function. This parameter is only available when using an LCD keypad.	0 (0 - 1)

0 : OFF

Stops the data log.

1 : ON

Starts the data log as specified by the sampling cycle set in o5-02 [*Log Sampling Interval*].

■ o5-02: Log Sampling Interval

No. (Hex.)	Name	Description	Default (Range)
o5-02 (1552) RUN	Log Sampling Interval	<div style="display: flex; gap: 5px;"> V/f CL-V/f OLV CLV AOLV OLV/PM AOLV/PM CLV/PM EZOLV </div> Sets the data log sampling cycle. This parameter is only available when using an LCD keypad.	100 ms (100 - 60000 ms)

■ o5-03: Log Monitor Data 1

No. (Hex.)	Name	Description	Default (Range)
o5-03 (1553) RUN	Log Monitor Data 1	<div style="display: flex; gap: 5px;"> V/f CL-V/f OLV CLV AOLV OLV/PM AOLV/PM CLV/PM EZOLV </div> Sets the data log monitor. This parameter is only available when using an LCD keypad.	101 (000, 101 - 999)

Note:

Set the *U monitor* number you want to log.

For example, to display *U1-01* [*Frequency Reference*], set o5-03 = 101. When it is not necessary to set a data log monitor, set this parameter to 000.

■ o5-04: Log Monitor Data 2

No. (Hex.)	Name	Description	Default (Range)
o5-04 (1554) RUN	Log Monitor Data 2	<div style="display: flex; gap: 5px;"> V/f CL-V/f OLV CLV AOLV OLV/PM AOLV/PM CLV/PM EZOLV </div> Sets the data log monitor. This parameter is only available when using an LCD keypad.	102 (000, 101 - 999)

Note:

Set the *U monitor* number you will log.

For example, to show *U1-02* [*Output Frequency*], set o5-04 = 102. When it is not necessary to set data log monitor, set this parameter to 000.

■ o5-05: Log Monitor Data 3

No. (Hex.)	Name	Description	Default (Range)
o5-05 (1555) RUN	Log Monitor Data 3	<div style="display: flex; justify-content: space-between; font-size: 0.8em; font-weight: bold;"> V/f CL-V/f OLV CLV AOLV OLV/PM AOLV/PM CLV/PM EZOLV </div> Sets the data log monitor. This parameter is only available when using an LCD keypad.	103 (000, 101 - 999)

Note:

Set the *U monitor* number you want to log.

For example, to show *U1-03 [Output Current]*, set *o5-05 = 103*. When it is not necessary to set a data log monitor, set this parameter to *000*.

■ o5-06: Log Monitor Data 4

No. (Hex.)	Name	Description	Default (Range)
o5-06 (1556) RUN	Log Monitor Data 4	<div style="display: flex; justify-content: space-between; font-size: 0.8em; font-weight: bold;"> V/f CL-V/f OLV CLV AOLV OLV/PM AOLV/PM CLV/PM EZOLV </div> Sets the data log monitor. This parameter is only available when using an LCD keypad.	107 (000, 101 - 999)

Note:

Set the *U monitor* number you want to log.

For example, to show *U1-07 [DC Bus Voltage]*, set *o5-06 = 107*. When it is not necessary to set a data log monitor, set this parameter to *000*.

■ o5-07: Log Monitor Data 5

No. (Hex.)	Name	Description	Default (Range)
o5-07 (1557) RUN	Log Monitor Data 5	<div style="display: flex; justify-content: space-between; font-size: 0.8em; font-weight: bold;"> V/f CL-V/f OLV CLV AOLV OLV/PM AOLV/PM CLV/PM EZOLV </div> Sets the data log monitor. This parameter is only available when using an LCD keypad.	108 (000, 101 - 999)

Note:

Set the *U monitor* number you want to log.

For example, to show *U1-08 [Output Power]*, set *o5-07 = 108*. When it is not necessary to set a data log monitor, set this parameter to *000*.

■ o5-08: Log Monitor Data 6

No. (Hex.)	Name	Description	Default (Setting Range)
o5-08 (1558) RUN	Log Monitor Data 6	<div style="display: flex; justify-content: space-between; font-size: 0.8em; font-weight: bold;"> V/f CL-V/f OLV CLV AOLV OLV/PM AOLV/PM CLV/PM EZOLV </div> Sets the data log monitor. This parameter is only available when using an LCD keypad.	105 (000, 101 - 999)

(Wrong type value. Set note.)

• When *A1-02 = 0 or 5 [Control Method Selection = V/f, OLV/PM]*, the default setting is *0*.

• Set the *U monitor* number you want to log.

For example, to display *U1-01 [Frequency Reference]*, set *o5-08 = 101*. When it is not necessary to set a data log monitor, set this parameter to *000*.

■ o5-09: Log Monitor Data 7

No. (Hex.)	Name	Description	Default (Range)
o5-09 (1559) RUN	Log Monitor Data 7	<div style="display: flex; justify-content: space-between; font-size: 0.8em; font-weight: bold;"> V/f CL-V/f OLV CLV AOLV OLV/PM AOLV/PM CLV/PM EZOLV </div> Sets the data log monitor. This parameter is only available when using an LCD keypad.	110 (000, 101 - 999)

Note:

Set the *U monitor* number you will log.

For example, to show *U1-01 [Frequency Reference]*, set *o5-09 = 101*. When it is not necessary to set data log monitor, set this parameter to *000*.

■ **o5-10: Log Monitor Data 8**

No. (Hex.)	Name	Description	Default (Range)
o5-10 (155A) RUN	Log Monitor Data 8	<div style="display: flex; justify-content: space-between; margin-bottom: 5px;"> V/f CL-V/f OLV CLV AOLV OLV/PM AOLV/PM CLV/PM EZOLV </div> Sets the data log monitor. This parameter is only available when using an LCD keypad.	112 (000, 101 - 999)

Note:

Set the *U monitor* number you want to log.

For example, to display *U1-01 [Frequency Reference]*, set *o5-10 = 101*. When it is not necessary to set a data log monitor, set this parameter to *000*.

■ **o5-11: Log Monitor Data 9**

No. (Hex.)	Name	Description	Default (Range)
o5-11 (155B) RUN	Log Monitor Data 9	<div style="display: flex; justify-content: space-between; margin-bottom: 5px;"> V/f CL-V/f OLV CLV AOLV OLV/PM AOLV/PM CLV/PM EZOLV </div> Sets the data log monitor. This parameter is only available when using an LCD keypad.	000 (000, 101 - 999)

Note:

Set the *U monitor* number you want to log.

For example, to display *U1-01 [Frequency Reference]*, set *o5-11 = 101*. When it is not necessary to set a data log monitor, set this parameter to *000*.

■ **o5-12: Log Monitor Data 10**

No. (Hex.)	Name	Description	Default (Range)
o5-12 (155C) RUN	Log Monitor Data 10	<div style="display: flex; justify-content: space-between; margin-bottom: 5px;"> V/f CL-V/f OLV CLV AOLV OLV/PM AOLV/PM CLV/PM EZOLV </div> Sets the data log monitor. This parameter is only available when using an LCD keypad.	000 (000, 101 - 999)

Note:

Set the *U monitor* number you want to log.

For example, to display *U1-01 [Frequency Reference]*, set *o5-12 = 101*. When it is not necessary to set a data log monitor, set this parameter to *000*.

12.12 T: Auto-Tuning

Numbers identifying the *T* parameters are displayed when an LED keypad is used. The names of the parameters are displayed on the LCD screen of the LCD keypad. Set the following.

- Induction Motor Auto-Tuning
- PM Motor Auto-Tuning
- ASR and Inertia Tuning

◆ T0: Tuning Mode Selection

■ T0-00: Tuning Mode Selection

When your control method supports Control Tuning, set *T0-00* first. Then, set *T1-00* [*Motor 1/Motor 2 Selection*] to select the motor you will tune. Then, set the tuning mode in *T2-01* [*PM Auto-Tuning Selection*] or *T3-00* [*Control Loop Tuning Selection*].

No. (Hex.)	Name	Description	Default (Range)
T0-00 (1197)	Tuning Mode Selection	<div style="display: flex; justify-content: space-between; align-items: center;"> V/f CL-V/f OLV CLV AOLV OLV/PM AOLV/PM CLV/PM EZOLV </div> Sets the type of Auto-Tuning.	0 (0, 1)

0 : Motor Parameter Tuning

1 : Control Tuning

Note:

The available tuning modes are different for different control methods.

◆ T1: Induction Motor Auto-Tuning

T1 parameters set the Auto-Tuning input data for induction motor tuning.

Note:

- The base frequency of drive dedicated motors and special motors for use with vector control may be lower than the base frequency of general-purpose motors, which is 50 Hz or 60 Hz. In such cases, this lower frequency is used as the value for *E1-06* [*Base Frequency*] and *E1-04* [*Maximum Output Frequency*] after Auto-Tuning completes. If the maximum output frequency is too low and causes problems, change the setting of *E1-04* after Auto-Tuning completes.
- The following induction motor parameters are set automatically.
 - E1-xx* [*V/f Pattern for Motor 1*]
 - E2-xx* [*Motor Parameters*]
 - E3-xx* [*V/f Pattern for Motor 2*]
 - E4-xx* [*Motor 2 Parameters*]
 - F1-xx* [*Encoder Options*] (only with Closed Loop Vector Control)

■ T1-00: Motor 1/Motor 2 Selection

No. (Hex.)	Name	Description	Default (Range)
T1-00 (0700)	Motor 1/Motor 2 Selection	<div style="display: flex; justify-content: space-between; align-items: center;"> V/f CL-V/f OLV CLV AOLV OLV/PM AOLV/PM CLV/PM EZOLV </div> Sets which motor to tune when motor 1/2 switching is enabled.	1 (1, 2)

Note:

This parameter is available when *H1-xx* = 16 [*Motor 2 Selection*]. The keypad will not show this parameter when *H1-xx* ≠ 16.

1 : Motor 1 (sets E1-xx, E2-xx)

Auto-Tuning automatically sets parameters *E1-xx* and *E2-xx* for motor 1.

2 : Motor 2 (sets E3-xx, E4-xx)

Auto-Tuning automatically sets parameters *E3-xx* and *E4-xx* for motor 2. Make sure that you connect motor 2 to the drive for Auto-Tuning.

■ T1-01: Auto-Tuning Mode Selection

No. (Hex.)	Name	Description	Default (Range)
T1-01 (0701)	Tuning Mode Selection	<input type="radio"/> V/f <input type="radio"/> CL-V/f <input type="radio"/> OLV <input type="radio"/> CLV <input type="radio"/> AOLV <input type="radio"/> OLV/PM <input type="radio"/> AOLV/PM <input type="radio"/> CLV/PM <input type="radio"/> EZOLV Sets the type of Auto-Tuning.	Determined by A1-02 (Determined by A1-02)

0 : Rotational Auto-Tuning

1 : Stationary Auto-Tuning 1

2 : Stationary Line-Line Resistance

■ T1-02: Motor Rated Power

No. (Hex.)	Name	Description	Default (Range)
T1-02 (0702)	Motor Rated Power	<input type="radio"/> V/f <input type="radio"/> CL-V/f <input type="radio"/> OLV <input type="radio"/> CLV <input type="radio"/> AOLV <input type="radio"/> OLV/PM <input type="radio"/> AOLV/PM <input type="radio"/> CLV/PM <input type="radio"/> EZOLV Uses the units set in <i>o1-58 [Motor Power Unit Selection]</i> to set the motor rated output power.	Determined by o2-04, C6-01 (0.00 - 650.00 HP)

■ T1-03: Motor Rated Voltage

No. (Hex.)	Name	Description	Default (Range)
T1-03 (0703)	Motor Rated Voltage	<input type="radio"/> V/f <input type="radio"/> CL-V/f <input type="radio"/> OLV <input type="radio"/> CLV <input type="radio"/> AOLV <input type="radio"/> OLV/PM <input type="radio"/> AOLV/PM <input type="radio"/> CLV/PM <input type="radio"/> EZOLV Sets the rated voltage (V) of the motor. Enter the base speed voltage for constant output motors.	Determined by o2-04, C6-01 (200 V Class: 0.0 - 255.5 V, 400 V Class: 0.0 - 511.0 V)

If you do Auto-Tuning on a drive-dedicated motor or a specialized motor for vector control, the voltage or frequency can be lower than that of a general-purpose motor. Always compare the data from the nameplate or test report with the Auto-Tuning results and check for differences. Enter the voltage necessary to operate the motor in no-load conditions at rated speed for better control precision around rated speed. If the motor test report or the motor nameplate is not available, enter approximately 90% of the motor rated voltage.

If the drive input power supply voltage is low, enter approximately 90% of the input voltage. When the input power supply voltage is low, the current will increase. Make sure that the main power supply capacity is correct and use a molded-case circuit breaker for the drive.

■ T1-04: Motor Rated Current

No. (Hex.)	Name	Description	Default (Range)
T1-04 (0704)	Motor Rated Current	<input type="radio"/> V/f <input type="radio"/> CL-V/f <input type="radio"/> OLV <input type="radio"/> CLV <input type="radio"/> AOLV <input type="radio"/> OLV/PM <input type="radio"/> AOLV/PM <input type="radio"/> CLV/PM <input type="radio"/> EZOLV Sets the rated current (A) of the motor.	Determined by o2-04 (10% to 200% of the drive rated current)

Set the motor rated current between 50% and 100% of the drive rated current for the best performance. Enter the current at the motor base speed.

■ T1-05: Motor Base Frequency

No. (Hex.)	Name	Description	Default (Range)
T1-05 (0705)	Motor Base Frequency	<input type="radio"/> V/f <input type="radio"/> CL-V/f <input type="radio"/> OLV <input type="radio"/> CLV <input type="radio"/> AOLV <input type="radio"/> OLV/PM <input type="radio"/> AOLV/PM <input type="radio"/> CLV/PM <input type="radio"/> EZOLV Sets the base frequency (Hz) of the motor.	60.0 Hz (0.0 - 590.0 Hz)

When Auto-Tuning is carried out, the value of *T1-05* is set to *E1-04 [Maximum Output Frequency]*. If *T1-05* < 40 Hz, *E1-04* = 40 Hz. If you operate the drive at a speed that is higher than the base frequency, or if you operate in the field weakening range, set *E1-04* (*E3-04* for motor 2) to the maximum output frequency after you complete Auto-Tuning.

■ T1-06: Number of Motor Poles

No. (Hex.)	Name	Description	Default (Range)
T1-06 (0706)	Number of Motor Poles	<input type="checkbox"/> V/f <input type="checkbox"/> CL-V/f <input type="checkbox"/> OLV <input checked="" type="checkbox"/> CLV <input type="checkbox"/> AOLV <input type="checkbox"/> OLV/PM <input type="checkbox"/> AOLV/PM <input type="checkbox"/> CLV/PM <input type="checkbox"/> EZOLV Sets the number of motor poles.	4 (2 to 120)

■ T1-07: Motor Base Speed

No. (Hex.)	Name	Description	Default (Range)
T1-07 (0707)	Motor Base Speed	<input type="checkbox"/> V/f <input type="checkbox"/> CL-V/f <input type="checkbox"/> OLV <input checked="" type="checkbox"/> CLV <input type="checkbox"/> AOLV <input type="checkbox"/> OLV/PM <input type="checkbox"/> AOLV/PM <input type="checkbox"/> CLV/PM <input type="checkbox"/> EZOLV Sets the motor base speed for Auto-Tuning (min^{-1} (r/min)).	1750 min^{-1} (r/min) (0 - 35400 min^{-1} (r/min))

■ T1-08: Encoder Pulse Count (PPR)

No. (Hex.)	Name	Description	Default (Range)
T1-08 (0708)	Encoder Pulse Count (PPR)	<input type="checkbox"/> V/f <input type="checkbox"/> CL-V/f <input type="checkbox"/> OLV <input checked="" type="checkbox"/> CLV <input type="checkbox"/> AOLV <input type="checkbox"/> OLV/PM <input type="checkbox"/> AOLV/PM <input type="checkbox"/> CLV/PM <input type="checkbox"/> EZOLV Sets the number of PG (pulse generator, encoder) pulses.	1024 ppr (0 - 60,000 ppr)

Set the actual number of pulses for one full motor rotation.

■ T1-09: Motor No-Load Current

No. (Hex.)	Name	Description	Default (Range)
T1-09 (0709)	Motor No-Load Current	<input type="checkbox"/> V/f <input type="checkbox"/> CL-V/f <input checked="" type="checkbox"/> OLV <input checked="" type="checkbox"/> CLV <input type="checkbox"/> AOLV <input type="checkbox"/> OLV/PM <input type="checkbox"/> AOLV/PM <input type="checkbox"/> CLV/PM <input type="checkbox"/> EZOLV Sets the no-load current of the motor.	- (0A - T1-04; max. of 2999.9)

Note:

The display units are different for different models:

- 2004 to 2042, 4002 to 4023: 0.01 A
- 2056 to 2415, 4031 to 4720: 0.1 A

The value shown is the no-load current that is automatically calculated from the values set in *T1-02 [Motor Rated Power]* and *T1-04 [Motor Rated Current]*. Set the no-load current shown on the motor test report. If the motor test report is not available, do not change this parameter.

■ T1-10: Motor Rated Slip Frequency

No. (Hex.)	Name	Description	Default (Range)
T1-10 (070A)	Motor Rated Slip Frequency	<input type="checkbox"/> V/f <input type="checkbox"/> CL-V/f <input checked="" type="checkbox"/> OLV <input checked="" type="checkbox"/> CLV <input type="checkbox"/> AOLV <input type="checkbox"/> OLV/PM <input type="checkbox"/> AOLV/PM <input type="checkbox"/> CLV/PM <input type="checkbox"/> EZOLV Sets motor rated slip.	- (0.000 - 20.000 Hz)

Shows 0.000 Hz as the default value. Set the rated slip shown on the motor test report. If the motor test report is not available, do not change this parameter.

■ T1-11: Motor Iron Loss

No. (Hex.)	Name	Description	Default (Range)
T1-11 (070B)	Motor Iron Loss	<input checked="" type="checkbox"/> V/f <input checked="" type="checkbox"/> CL-V/f <input type="checkbox"/> OLV <input type="checkbox"/> CLV <input type="checkbox"/> AOLV <input type="checkbox"/> OLV/PM <input type="checkbox"/> AOLV/PM <input type="checkbox"/> CLV/PM <input type="checkbox"/> EZOLV Sets the iron loss for calculating the energy-saving coefficient.	Determined by E2-11 or E4-11 (0 - 65535 W)

Note:

The default setting is different for different motor codes and motor parameter settings.

The value shown is the *E2-10 [Motor Iron Loss]* or *E4-10 [Motor 2 Iron Loss]* for the motor output set in *T1-02 [Motor Rated Power]*. If the motor test report is available, enter the motor iron loss value to *T1-11*.

■ T1-12: Test Mode Selection

No. (Hex.)	Name	Description	Default (Range)
T1-12 (0BDB)	Test Mode Selection	<div style="display: flex; justify-content: space-between; font-size: 0.8em;"> V/f CL-V/f OLV CLV AOLV OLV/PM AOLV/PM CLV/PM EZOLV </div> <p>Sets the function to enable Test Mode after Stationary Auto-Tuning. When you can operate the motor with a light load attached after Stationary Auto-Tuning is complete, enable this parameter.</p>	0 (0, 1)

0 : No

1 : Yes

After Auto-Tuning, the drive automatically sets *E2-02 [Motor Rated Slip]* and *E2-03 [Motor No-Load Current]* when you operate the motor for the first time in Drive Mode.

Note:

After Auto-Tuning is complete and you set the drive to Drive Mode, operate the motor in these conditions:

- Make sure that you connect all wiring between the drive and motor
- Make sure that a mechanical brake on the motor shaft is not locked
- Keep the motor-load ratio at 30%
- Hold constant speed for longer than 1 second at a minimum of 30% of the speed set in *E1-06 [Base Frequency]* (the default setting is the same as the maximum frequency).

■ T1-13: No-load voltage

No. (Hex.)	Name	Description	Default (Range)
T1-13 (0BDC)	No-load voltage	<div style="display: flex; justify-content: space-between; font-size: 0.8em;"> V/f CL-V/f OLV CLV AOLV OLV/PM AOLV/PM CLV/PM EZOLV </div> <p>Sets the no-load voltage of the motor. If you know the no-load voltage at the rated speed in a test report, set that voltage value. If you do not know the no-load voltage, do not change from the initial value.</p>	T1-03 × 0.85 (200 V Class: 0.0 - 255.0 V, 400 V Class: 0.0 - 510.0 V)

Note:

- To get the same qualities as a Yaskawa 1000-series drive or previous models, set this parameter = *T1-03 [Motor Rated Voltage]* value.
- The default value is different for different models.
 - 2004 - 2008, 4002 - 4004: T1-03 × 0.85
 - 2010 - 2415, 4005 - 4302: T1-03 × 0.90
 - 4371- 4720: T1-03 × 0.95

◆ T2: PM Motor Auto-Tuning

T2 parameters set the Auto-Tuning input data for PM motor tuning.

Note:

The drive automatically sets these PM motor parameters:

- E1-xx [V/f Pattern for Motor 1]
- E5-xx [V/f Pattern for Motor 1]
- F1-xx [Encoder Option Setup]
Only when *A1-02 = 7 [Control Method Selection = PM Closed Loop Vector]*

■ T2-01: PM Auto-Tuning Selection

No. (Hex.)	Name	Description	Default (Range)
T2-01 (0750)	PM Auto-Tuning Selection	<div style="display: flex; justify-content: space-between; font-size: 0.8em;"> V/f CL-V/f OLV CLV AOLV OLV/PM AOLV/PM CLV/PM EZOLV </div> <p>Sets the type of Auto-Tuning for PM motors.</p>	0 (Determined by A1-02)

Note:

Yaskawa recommends Rotational (Ld, Lq, R, back-EMF) for specialized motors. Rotational Auto-Tuning rotates the motor to measure the actual induction voltage constants for more accurate control than Stationary Auto-Tuning.

0 : Manual Entry w/ Motor Data Sheet

1 : Stationary (Ld, Lq, R)

2 : Stationary (R Only)

3 : Z-Pulse Offset (Pole Position)

4 : Rotational (Ld, Lq, R, back-EMF)**5 : High Frequency Injection****■ T2-02: PM Motor Code Selection**

No. (Hex.)	Name	Description	Default (Range)
T2-02 (0751)	PM Motor Code Selection	V/f CL-V/f OLV CLV AOLV OLV/PM AOLV/PM CLV/PM EZOLV If the drive is operating a Yaskawa PM motor from the SMRA, SSR1, or SST4 series, enter the PM motor code in accordance with the rotation speed and motor output.	FFFF (0000 - FFFF)

Enter the motor code in *T2-02* to automatically set parameters *T2-03* to *T2-14*. When you are operating a specialized motor or a non-Yaskawa motor designed, set *T2-02* = *FFFF* and enter the data from the motor nameplate or the motor test report.

You can only enter the permitted PM motor codes. Different drive control methods will accept different PM motor codes.

■ T2-03: PM Motor Type

No. (Hex.)	Name	Description	Default (Range)
T2-03 (0752)	PM Motor Type	V/f CL-V/f OLV CLV AOLV OLV/PM AOLV/PM CLV/PM EZOLV Sets the type of PM motor the drive will operate.	1 (0, 1)

0 : IPM motor**1 : SPM motor****■ T2-04: PM Motor Rated Power**

No. (Hex.)	Name	Description	Default (Range)
T2-04 (0730)	PM Motor Rated Power	V/f CL-V/f OLV CLV AOLV OLV/PM AOLV/PM CLV/PM EZOLV Uses the units set in <i>o1-58</i> [Motor Power Unit Selection] to set the PM motor rated output power.	Determined by <i>o2-04</i> , <i>C6-01</i> (0.00 - 650.00 HP)

■ T2-05: PM Motor Rated Voltage

No. (Hex.)	Name	Description	Default (Range)
T2-05 (0732)	PM Motor Rated Voltage	V/f CL-V/f OLV CLV AOLV OLV/PM AOLV/PM CLV/PM EZOLV Sets the rated voltage (V) of the motor.	200 V Class: 230.0 V, 400 V: 460.0 V (200 V Class: 0.0 - 255.0 V, 400 V Class: 0.0 - 510.0 V)

■ T2-06: PM Motor Rated Current

No. (Hex.)	Name	Description	Default (Range)
T2-06 (0733)	PM Motor Rated Current	V/f CL-V/f OLV CLV AOLV OLV/PM AOLV/PM CLV/PM EZOLV Sets the rated current (A) of the motor.	Determined by <i>o2-04</i> (10% to 200% of the drive rated current)

■ T2-07: PM Motor Base Frequency

No. (Hex.)	Name	Description	Default (Range)
T2-07 (0753)	PM Motor Base Frequency	V/f CL-V/f OLV CLV AOLV OLV/PM AOLV/PM CLV/PM EZOLV Sets the base frequency (Hz) of the motor.	60.0 Hz (0.0 - 590.0 Hz)

■ T2-08: Number of PM Motor Poles

No. (Hex.)	Name	Description	Default (Range)
T2-08 (0734)	Number of PM Motor Poles	<div style="display: flex; justify-content: space-between; font-size: 0.8em;"> V/f CL-V/f OLV CLV AOLV OLV/PM AOLV/PM CLV/PM EZOLV </div> Sets the number of motor poles.	4 (2 - 48)

■ T2-09: PM Motor Base Speed

No. (Hex.)	Name	Description	Default (Range)
T2-09 (0731)	PM Motor Base Speed	<div style="display: flex; justify-content: space-between; font-size: 0.8em;"> V/f CL-V/f OLV CLV AOLV OLV/PM AOLV/PM CLV/PM EZOLV </div> Sets the motor base speed (min ⁻¹ (r/min)).	1750 min ⁻¹ (r/min) (0 - 34500 min ⁻¹ (r/min))

■ T2-10: PM Motor Stator Resistance

No. (Hex.)	Name	Description	Default (Range)
T2-10 (0754)	PM Motor Stator Resistance	<div style="display: flex; justify-content: space-between; font-size: 0.8em;"> V/f CL-V/f OLV CLV AOLV OLV/PM AOLV/PM CLV/PM EZOLV </div> Sets the stator resistance for each motor phase.	Determined by T2-02 (0.000 - 65.000 Ω)

Note:

This parameter does not set line-to-line resistance.

■ T2-11: PM Motor d-Axis Inductance

No. (Hex.)	Name	Description	Default (Range)
T2-11 (0735)	PM Motor d-Axis Inductance	<div style="display: flex; justify-content: space-between; font-size: 0.8em;"> V/f CL-V/f OLV CLV AOLV OLV/PM AOLV/PM CLV/PM EZOLV </div> Sets the d-axis inductance of the motor on a per phase basis.	Determined by T2-02 (0.00 - 600.00 mH)

■ T2-12: PM Motor q-Axis Inductance

No. (Hex.)	Name	Description	Default (Range)
T2-12 (0736)	PM Motor q-Axis Inductance	<div style="display: flex; justify-content: space-between; font-size: 0.8em;"> V/f CL-V/f OLV CLV AOLV OLV/PM AOLV/PM CLV/PM EZOLV </div> Sets the q-axis inductance of the motor on a per phase basis.	Determined by T2-02 (0.00 - 600.00 mH)

■ T2-13: Back-EMF Units Selection

No. (Hex.)	Name	Description	Default (Range)
T2-13 (0755)	Back-EMF Units Selection	<div style="display: flex; justify-content: space-between; font-size: 0.8em;"> V/f CL-V/f OLV CLV AOLV OLV/PM AOLV/PM CLV/PM EZOLV </div> Sets the units that the drive uses to set the induced voltage constant.	0 (0, 1)

0 : mV/(rev/min)

1 : mV/(rad/s)

Note:

- When $T2-13 = 0$, the drive will use $E5-24$ [PM Back-EMF L-L V_{rms} (mV/rpm)] and will automatically set $E5-09$ [PM Back-EMF V_{peak} (mV/(rad/s))] = 0.0.
- When $T2-13 = 1$, the drive will use $E5-09$ and will automatically set $E5-24 = 0.0$.

■ T2-14: Back-EMF Voltage Constant (Ke)

No. (Hex.)	Name	Description	Default (Range)
T2-14 (0737)	Back-EMF Voltage Constant (Ke)	<div style="display: flex; justify-content: space-between; font-size: 0.8em;"> V/f CL-V/f OLV CLV AOLV OLV/PM AOLV/PM CLV/PM EZOLV </div> Sets the motor induced voltage constant (Ke).	Determined by T2-13 (0.0 - 2000.0)

■ T2-15: Pull-In Current Level

No. (Hex.)	Name	Description	Default (Range)
T2-15 (0756)	Pull-In Current Level	V/f CL-V/f OLV CLV AOLV OLV/PM AOLV/PM CLV/PM EZOLV Sets the level of the pull-in current as a percentage of E5-03 [PM Motor Rated Current (FLA)]. Usually it is not necessary to change this setting.	30% (0 - 120%)

If the load inertia is high, increase the setting value.

■ T2-16: Encoder Pulse Count (PPR)

No. (Hex.)	Name	Description	Default (Range)
T2-16 (0738)	Encoder Pulse Count (PPR)	V/f CL-V/f OLV CLV AOLV OLV/PM AOLV/PM CLV/PM EZOLV Sets the number of PG (pulse generator, encoder) pulses.	1024 ppr (1 - 15000 ppr)

Set the actual number of pulses for one full motor rotation.

■ T2-17: Encoder Z-Pulse Offset

No. (Hex.)	Name	Description	Default (Range)
T2-17 (0757)	Encoder Z-Pulse Offset	V/f CL-V/f OLV CLV AOLV OLV/PM AOLV/PM CLV/PM EZOLV Sets the encoder Z-pulse offset ($\Delta\theta$) (pulse generator, encoder) that is listed on the motor nameplate.	0.0 ° (-180.0 - +180.0°)

If you do not know the quantity of encoder (pulse generator, encoder) Z-pulse offset, or if you replaced the encoder, do Z Pulse Offset Tuning and correct for the offset ($\Delta\theta$) from the Z phase.

◆ T3: ASR and Inertia Tuning

■ T3-00: Control Loop Tuning Selection

No. (Hex.)	Name	Description	Default (Range)
T3-00 (1198)	Control Loop Tuning Selection	V/f CL-V/f OLV CLV AOLV OLV/PM AOLV/PM CLV/PM EZOLV Sets the type of Control Auto-Tuning.	0 (0 - 3)

0 : Inertia Tuning

1 : ASR (Speed Regulator)

2 : Deceleration Rate Tuning

3 : KEB Tuning

Note:

Settings 0 and 1 are available only when A1-02 = 3, 7 [Control Method Selection = CLV, CLV/PM].

■ T3-01: Test Signal Frequency

No. (Hex.)	Name	Description	Default (Range)
T3-01 (0760)	Test Signal Frequency	V/f CL-V/f OLV CLV AOLV OLV/PM AOLV/PM CLV/PM EZOLV Sets the frequency of the test signal applied to the motor during Inertia Tuning. Usually it is not necessary to change this setting.	3.0 Hz (0.1 - 20.0 Hz)

If the load inertia is too large and the drive detects a fault after Inertia Tuning, decrease the setting.

■ T3-02: Test Signal Amplitude

No. (Hex.)	Name	Description	Default (Range)
T3-02 (0761)	Test Signal Amplitude	V/f CL-V/f OLV CLV AOLV OLV/PM AOLV/PM CLV/PM EZOLV Sets the amplitude of the test signal applied to the motor during Inertia Tuning. Usually it is not necessary to change this setting.	0.5 rad (0.1 - 10.0 rad)

If the load inertia is too large and the drive detects a fault after Inertia Tuning, decrease the setting. If the drive detects a fault when *T3-01 [Test Signal Frequency]* is set to a low value, adjust this parameter.

■ **T3-03: Motor Inertia**

No. (Hex.)	Name	Description	Default (Range)
T3-03 (0762)	Motor Inertia	<div style="display: flex; justify-content: space-between; font-size: 0.8em;"> V/f CL-V/f OLV CLV AOLV OLV/PM AOLV/PM CLV/PM EZOLV </div> <p>Sets the inertia of the motor. This value uses the test signal response to calculate the load inertia.</p>	Determined by o2-04, C6-01, and E5-01 (0.0001 - 600.00 kgm ²)

The default setting is for a Yaskawa standard motor as shown in the motor inertia table. Actual values will be different when you use induction motors or PM motors.

Note:

- The display units for the default setting and setting range are different for different models:
- 0.0001 kgm² units (setting range: 0.0001 kgm² to 6.0000 kgm²): 2004 to 2021, 4002 to 4012
 - 0.001 kgm² units (setting range: 0.001 kgm² to 60.000 kgm²): 2030 to 2211, 4018 to 4103
 - 0.01 kgm² units (setting range: 0.01 kgm² to 600.00 kgm²): 2257 to 2415, 4140 to 4720

■ **T3-04: System Response Frequency**

No. (Hex.)	Name	Description	Default (Range)
T3-04 (0763)	System Response Frequency	<div style="display: flex; justify-content: space-between; font-size: 0.8em;"> V/f CL-V/f OLV CLV AOLV OLV/PM AOLV/PM CLV/PM EZOLV </div> <p>This parameter uses the load inertia value from the Inertia Tuning process to automatically calculate and set <i>C5-01 [ASR Proportional Gain I]</i>.</p>	10.0 Hz (0.1 - 50.0 Hz)

If this input value is too high, it can cause oscillation.

◆ **T4: EZ Tuning**

Use *T4 parameters* to input the data necessary for motor parameter Auto-Tuning when *A1-02 = 8 [Control Method Selection = EZ Vector Control]*. These two modes are available:

T4-01 Setting	Operational overview	Items input for tuning	Items tuned
0	Follow the instructions in the setup wizard on the keypad to manually enter the necessary motor parameters.	<ul style="list-style-type: none"> • T4-02 [Motor Type Selection] • T4-03 [Motor Max Revolutions] • T4-04 [Motor Rated Revolutions] • T4-05 [Motor Rated Frequency] <i>*1</i> • T4-06 [Motor Rated Voltage] • T4-07 [Motor Rated Current] • T4-08 [Motor Rated Capacity] • T4-09 [Number of Poles] 	<ul style="list-style-type: none"> • E9-01 [Motor Type Selection] • E9-02 [Maximum Speed] • E9-03 [Rated Speed] • E9-04 [Base Frequency] • E9-05 [Base Voltage] • E9-06 [Motor Rated Current (FLA)] • E9-07 [Motor Rated Power] • E9-08 [Motor Pole Count] • E9-09 [Motor Rated Slip] • E9-10 [Motor Line-to-Line Resistance]
1	Do only line-to-line resistance tuning.	Motor Rated Current	E9-10 [Motor Line-to-Line Resistance]

*1 When you use a PM motor or a synchronous reluctance motor, it is not necessary to enter the rated frequency. The drive will use the rated rotation speed and number of motor poles to automatically calculate the rated frequency.

■ **T4-01: EZ Tuning Mode Selection**

No. (Hex.)	Name	Description	Default (Range)
T4-01 (3130)	EZ Tuning Mode Selection	<div style="display: flex; justify-content: space-between; font-size: 0.8em;"> V/f CL-V/f OLV CLV AOLV OLV/PM AOLV/PM CLV/PM EZOLV </div> <p>Sets the type of Auto-Tuning for EZOLV control.</p>	0 (0, 1)

0 : Motor Parameter Setting

1 : Line-to-Line Resistance

■ T4-02: Motor Type Selection

No. (Hex.)	Name	Description	Default (Range)
T4-02 (3131)	Motor Type Selection	<div style="display: flex; justify-content: space-between; align-items: center;"> V/f CL-V/f OLV CLV AOLV OLV/PM AOLV/PM CLV/PM EZOLV </div> Sets the type of motor.	0 (0, 1, 2)

0 : Induction (IM)

1 : Permanent Magnet (PM)

2 : Synchronous Reluctance (SynRM)

■ T4-04: Motor Rated Revolutions

No. (Hex.)	Name	Description	Default (Range)
T4-04 (3133)	Motor Rated Revolutions	<div style="display: flex; justify-content: space-between; align-items: center;"> V/f CL-V/f OLV CLV AOLV OLV/PM AOLV/PM CLV/PM EZOLV </div> Sets rated rotation speed (min ⁻¹) of the motor.	- ((40 Hz to 120 Hz) × 60 × 2/ E9-08)

■ T4-05: Motor Rated Frequency

No. (Hex.)	Name	Description	Default (Range)
T4-05 (3134)	Motor Rated Frequency	<div style="display: flex; justify-content: space-between; align-items: center;"> V/f CL-V/f OLV CLV AOLV OLV/PM AOLV/PM CLV/PM EZOLV </div> Sets the rated frequency (Hz) of the motor.	Determined by E9-01 and o2-04 (40.0 - 120.0 Hz)

Note:

When $T4-02 = 1, 2$ [Motor Type Selection = PM, SynRM], input is not necessary because it assumes: Motor Rated Revolutions/60 × Number of Motor Poles/2.

■ T4-06: Motor Rated Voltage

No. (Hex.)	Name	Description	Default (Range)
T4-06 (3135)	Motor Rated Voltage	<div style="display: flex; justify-content: space-between; align-items: center;"> V/f CL-V/f OLV CLV AOLV OLV/PM AOLV/PM CLV/PM EZOLV </div> Sets the rated voltage (V) of the motor.	200 V Class: 230.0 V, 400 V: 460.0 V (200 V Class: 0.0 - 255.0 V, 400 V Class: 0.0 - 510.0 V)

■ T4-07: Motor Rated Current

No. (Hex.)	Name	Description	Default (Range)
T4-07 (3136)	Motor Rated Current	<div style="display: flex; justify-content: space-between; align-items: center;"> V/f CL-V/f OLV CLV AOLV OLV/PM AOLV/PM CLV/PM EZOLV </div> Sets the rated current (A) of the motor.	Determined by o2-04, C6-01 (10% to 200% of the drive rated current)

Note:

The value set here becomes the base value for motor protection, the torque limit, and torque control.

■ T4-08: Motor Rated Capacity

No. (Hex.)	Name	Description	Default (Range)
T4-08 (3137)	Motor Rated Capacity	<div style="display: flex; justify-content: space-between; align-items: center;"> V/f CL-V/f OLV CLV AOLV OLV/PM AOLV/PM CLV/PM EZOLV </div> Sets the motor rated power in the units set in o1-58 [Motor Power Unit Selection].	Determined by E9-10 (0.10 - 650.00 HP)

■ T4-09: Number of Poles

No. (Hex.)	Name	Description	Default (Range)
T4-09 (3138)	Number of Poles	<div style="display: flex; justify-content: space-between; align-items: center;"> V/f CL-V/f OLV CLV AOLV OLV/PM AOLV/PM CLV/PM EZOLV </div> Sets the number of motor poles.	Determined by E9-01 (2 - 48)

Index

Symbols

Numerics

24 V power supply

Power supply input terminals 95

A

AC reactor

Wiring 120

Acceleration and deceleration times

Switching by external input 711

Switching by output frequency 712

Switching by Motor 2 Selection commands 712

Acceleration time

Parameter 711

Unit of measurement setting 714

Adjustment of control functionality 202

AER 337

AFR

Parameter 951

Alarm 310, 337

ALM indicator 135, 138

ALM/ERR

LED status 141

Altitude

Derating 451

Environment 34

Ambient humidity 34

Ambient Temperature Setting

Derating 450

Parameter 943

Analog gauge

Monitors 157

Analog input

Function selection for terminals A1 through A3 870

Analog Output

Gain/Bias Adjustment 884

Monitor Parameter Selection 884

Signal Level Selection 884

Terminal AM Monitor Selection 886

Terminal FM Monitor Selection 885

Application Preset 643

Operation 189

ASR

Closed Loop V/f Control adjustment procedure 725

Fine tuning 727

Parameter 724

Vector Control Adjustment Procedure 725

ASR tuning 195

Precautions 199

Auto-Tuning 191

ASR and Inertia Tuning Parameters 1003

ASR tuning 195

Induction Motor 191

Induction Motor Parameters 997

Inertia Tuning 195

PM Motor Parameters 1000

PM Motors 192

Precautions 197

Precautions to Note before ASR Tuning 199

Precautions to Note before Inertia Tuning 199

Procedure 174

Rotational Auto-Tuning Precautions 198

Stationary Auto-Tuning for Line-to-Line Resistance

precautions 199

Stationary Auto-Tuning Precautions 198

Stator resistance Auto-Tuning precautions 199

Auto-Tuning Error 310, 353

B

Backlight

Timing of shut-off 185

Backup

Parameters (drive to keypad) 166

Backup function 987

Bar graph

Monitors 155

Base frequency

Parameter 766

Base Frequency

Motor 2 Parameters 771

Base voltage

Motor 2 parameters 772

Parameter 767

Basic operation

Get started 143

bAT

Fault 317

Minor Fault 337

Battery

Disposal 429

Replacement 423

Specifications 423

bb 337

bCE

Fault 317

Minor Fault 337

Bi-Directional function 751

boL

Fault 317

Minor Fault 337

Braking Resistor

Protective function 940

Wiring 108

bUS

Detection condition settings 810

Detection conditions 806

Fault 317

Minor Fault 337

Operation Selection after Detection 805

C

CALL 338

Capacitor Maintenance Setting 989

Carrier frequency

Diminish 945

Parameter 733

Carrier Frequency

Derating 446

CDBR type braking unit

Connect multiple units 115

Wiring 109

CE

Detection Selection 889

Detection Time	889	Deceleration time	
Fault	317	Parameter	711
Minor Fault	338	Unit of measurement setting	714
Operation Selection after Detection	888	Delete	
CF	318	Delete Backed-up Parameters	169
Checklist		Derating	
Test run	209	Altitude	451
Circulation Fan		Ambient Temperature Setting	450, 943
Replacement	380	Carrier Frequency	446
CoF	318	Enclosure Type	945
Communication option		External Cooling Fin	945
Parameter	800	Finless	945
Connecting multiple drives	801	Side-by-side	945
Control circuit terminal block		dEv	
Replacement	417	Detection level	783
Control circuit terminals		Detection time	783
Configuration of terminal block	96	Fault	319
I/O terminals function selection switches	101	Minor Fault	339
Terminal functions	93	Operation Selection after Detection	782
Wire gauge	97	dFPS	358
Wiring	92	DI-A3	
Wiring procedure for terminal block	98	Parameter	790
Control method		Diagnosing and Resetting Faults	360
Selection	640	Digital input option	
Cooling Fan		Parameter	790
Activation Conditions Setting	942	Digital output option	
Estimated Lifespan	377	Parameter	797
Off Delay Timer	943	DIP switch	101
Replacement	380	Disposal	
Copy Function Error	310, 358	Battery	429
CP1		Drive	429–430
Fault	318	microSD card	429
Minor Fault	338	Packing material	429–430
CP2		dnE	339
Fault	319	DO-A3	
Minor Fault	338	Parameter	797
CPEr	358	Down 2 command	
CPF00 to CPF03	319	Parameter	746, 751
CPF06	319	Down command	830–831
CPF07 to CPF08	319	Parameter	746, 751
CPF11 to CPF14	319	Drive	
CPF16 to CPF24	319	Control Circuit Terminal Block Replacement	417
CPF25	319	Disposal	429–430
CPF26 to CPF39	319	Exterior Dimensions Diagram (IP20)	453, 455–462, 473–477
CPyE	358	Exterior Dimensions Diagram (UL Type 1)	463, 465–472
Crimp ferrule	97	Initialization	641
CrST	339	Initialize Parameters	641
CSEr	358	Inspection	374
Cumulative Operation TimeSetting	988	Long-Term Storage	425
Current Detection Speed Search	675	Rating (200 V)	434
CyC	339	Rating (400 V)	436
CyPo	339	Drive Mode Unit Monitor Select	976
D		Drive Model Selection	984
Data log	183	Drive watt loss	443
Monitor selection	183	Droop Control	
Sampling time	184	Parameter	703
Start procedure	182	dv1	319
Stop procedure	182	dv2	320
DC Injection Braking		Detection condition settings	784
Parameter	671	Detection level	787
DC link choke		Detection method settings	787
Wiring	120	dv3	320
		Detection condition settings	784

dv4	320	End7	353
Detection condition settings	785	End8	354
dv7	321	End9	354
dWA2	339	Energy-saving control	
dWA3	339	Parameter	704
dWAL	339	Enter command	282
Dwell function		EP24v	341
Parameter	702	Er-01	354
dWF1	321	Er-02	354
dWF2	321	Er-03	354
dWF3	321	Er-04	354
dWFL	321	Er-05	355
E		Er-08	355
E5		Er-09	355
Fault	321	Er-10	355
Minor Fault	339	Er-11	355
Operation Selection after Detection	809	Er-12	355
EF	340	Er-13	356
EF0		Er-14	356
Detection conditions	806	Er-15	356
Detection conditions setting (DeviceNet)	813	Er-16	356
Fault	321	Er-17	356
Minor Fault	340	Er-18	356
Operation Selection after Detection	806	Er-19	356
EF1		Er-20	356
Fault	322	Er-21	356
Minor Fault	340	Er-25	357
EF2		ERF type braking resistor	
Fault	322	Protective function	940
Minor Fault	340	Wiring	108
EF3		Err	323
Fault	322	Error Code List	311
Minor Fault	340	Exterior and Mounting Dimensions	
EF4		Installation Dimensions	52
Fault	322	Panel Cut Out Dimensions	52
Minor Fault	340	Exterior Dimensions Diagram (IP20)	
EF5		Drive	453, 455–462, 473–477
Fault	322	Exterior Dimensions Diagram (UL Type 1)	
Minor Fault	340	Drive	463, 465–472
EF6		External 24 V power supply	
Fault	322	Power supply input terminals	95
Minor Fault	341	External Cooling Fin	
EF7		Derating	945
Fault	323	F	
Minor Fault	341	Fan Operation Time Setting	989
EF8		FAn1	323
Fault	323	Fast Stop Time	
Minor Fault	341	Parameter	714
Elapsed Operating Time Selection	989	Fault	310, 317
Electrolytic Capacitor		Fault code	
Estimated Lifespan	377	MEMOBUS/Modbus	302
Enclosure Type		Fault Code List	311
Change to IP20/UL Type 1	51	Fault history	
Derating	945	Display procedure	173
Encoder option		Fault Reset	360
Parameter	780	Fault Restart	
End1	353	Parameter	928
End2	353	FbH	
End3	353	Fault	323
End4	353	Minor Fault	341
End5	353	FbL	
End6	353	Fault	323

Minor Fault.....	341	Protective function	941
Feed Forward Control		Input voltage	
Parameter	959	Parameter	760
Field Forcing		Inspection	
Parameter	756	Drive	374
Field weakening		Installation	
Parameter	756	Front cover	46
Fine tuning	202	Keypad	39
Finless		Terminal cover	46
Derating	945	UL Type 1 protective cover	51
Firmware update lock.....	656	Installation Dimensions	52
Freq Ref Setting Method Select.....	985	Installation environment	34
Freq reference bias		Interlock	
Parameter	751	Circuit example	107
Frequency Agreement		Internal Drive Braking Transistor	
Parameter	927	Protective function	947
Frequency reference		IP20/UL Type 1	
Command source correlation diagram.....	738	Attach protective cover	51
LOCAL/REMOTE Run selection.....	658, 738	J	
Making changes using keypad.....	151	Jog command	744
Offset frequency addition	757	Jog operation.....	151
Switching between LOCAL/REMOTE	658, 667, 738	JOG operation	151
Upper and lower frequency limits.....	744	Jump frequency	
Frequency reference bias		Parameter	745
Parameter	746	Jumper switch	101
Frequency reference hold function		K	
Parameter	746, 751	KEB ride-thru function	
Fuse rating	124	Compensation Time	913
G		Operation during momentary power loss.....	912
Gateway mode.....	801	Parameter	906
Getting set up	143	KEB Ride-Thru Function	
GF	324	KEB Method Selection	916
Protective function	942	Single Drive KEB Method	916
Ground		System KEB Method.....	916
Drive	82	Keypad	
Ground Fault Circuit Interrupter		Application Preset	189
GFCI	117	Backlight setting	185
Wiring.....	117	Battery Replacement	423
Ground Fault Detection		Data log setting	183
Protective function	942	Display drive information	186
H		Display software version	186
HCA.....	342	External dimensions.....	40
Alarm Settings	946	HOME screen.....	151
HD.....	433	Installation.....	39
Heavy Duty Rating.....	433	Installation on control panel	40
High-Slip Braking		Language selection	176, 639
Parameter	952	Meaning of indicators.....	135
HLCE	324	Method of operation.....	135
HOME screen.....	151	Remove	39
Horsepower	982	Set date and time	177
How to read the catalog codes.....	23	Set time	177
Humidity		Setup Wizard.....	179
Environment.....	34	Start/stop data logging	182
I		Keypad Display	975
iFEr.....	358	Keypad Display Selection.....	976
IGBT Maintenance Setting	989	Keypad Operation.....	982
Induction Motor		Keypad-related settings.....	975
Auto-Tuning.....	191	kWh Monitor Initialization	990
Inertia Tuning	195	L	
Precautions	199	L24v.....	342
Input Phase Detection		Language selection	639

Procedure	176	microSD card	
LCD contrast adjustment	978	Disposal	429
LED Light Function Selection	986	Insertion slot	135
LED status ring		Mid point B frequency	
ALM/ERR	141	Motor 2 parameters	771
Ready	141	Parameter	766
RUN	141	Mid point B voltage	
LF	324	Motor 2 parameters	772
Protective function	942	Parameter	767
LF2	324	Middle Output Frequency	
Protection Functions	944	Motor 2 Parameters	771
LKEB type braking resistor unit		Parameter	766
Wiring	108	Middle Output Frequency Voltage	
Load Inertia Ratio		Motor 2 Parameters	771
Parameter	925	Parameter	766
LO/RE Key Function Selection	982	Minimum output frequency	
LOCAL/REMOTE indicator	135, 138	Parameter	766
LoG	342	Minimum Output Frequency	
LSo	325	Motor 2 Parameters	771
Protective function	948	Induction Motor	
LT-1	342	Motor Parameters	767
LT-2	342	Minimum Output Voltage	
LT-3	342	Motor 2 Parameters	771
LT-4	342	Parameter	766
M		Minor Fault	310, 337
Main circuit terminals		Minor fault code	
Configuration of terminal block	65	MEMOBUS/Modbus	303
Line voltage drop	71	Minor Fault Code List	311
Wire gauge	71	Modbus	
Wiring	65	Broadcast Messages	302
Wiring procedure for terminal block	86	Command data	283
Main menu		Communication error code	304
Display procedure	151	Communication specifications	272
Maintenance Period	988	Enter command	282
Maximum Output Frequency		Fault code	302
Motor 2 Parameters	770	Loopback test	278
Parameter	765	Minor fault code	303
Maximum Output Voltage		Monitor data	287
Motor 2 Parameters	771	Register reading	277
Parameter	766	Register writing	278
MCCB	117	Self-diagnosis	283
Mechanical Weakening Detection		Wiring	272
Parameter	933	Molded-case circuit breaker	117
MEMOBUS		Momentary Power Loss	
Broadcast Messages	302	KEB Compensation Time	913
Command data	283	Monitors	
Communication error code	304	Data log setting	183–184
Communication specifications	272	Display analog gauge	157
Enter command	282	Display bar graph	155
Fault code	302	Display procedure	152
Loopback test	278	Set custom monitors	153
Minor fault code	303	Show custom monitors	154
Monitor data	287	Start/stop data logging	182
Register reading	277	Trend Plot Display	158
Register writing	278	Motor	
Self-diagnosis	283	Change direction of motor rotation	151
Wiring	272	Positive Temperature Coefficient (PTC) Thermistor	900
MEMOBUS/Modbus communications		Wiring	65
Setting for termination resistor	105	Wiring distance	82
MEMOBUS/Modbus Communications		Motor 2	
Parameter	887	Base Frequency	771
Serial communication terminals	96	Base voltage	772
		Control mode settings	770

Leakage Inductance	773	NumOfRunCommands Counter Initial	990
Line-to-Line Resistance	773	O	
Maximum Output Frequency	770	oC	325
Maximum Output Voltage	771	Overcurrent Detection Gain	944
Mid point B frequency	771	oFA00	326
Mid point B voltage	772	oFA01	326
Middle Output Frequency	771	oFA02	326
Middle Output Frequency Voltage	771	oFA03 to oFA06	326
Minimum Output Frequency	771	oFA10	327
Minimum Output Voltage	771	oFA11	327
Motor Iron Loss	774	oFA12 to oFA17	327
Motor Iron-Core Saturation Coefficient 1	774	oFA30 to oFA43	327
Motor Iron-Core Saturation Coefficient 2	774	oFb00	327
Motor rated power (kW)	774	oFb01	327
No-load Current	773	oFb02	327
Number of motor poles	773	oFb03 to oFb11	327
Rated current	772	oFb12 to oFb17	327
Rated Slip	772	oFC00	328
V/f Pattern	770	oFC01	328
Motor Code Selection	775	oFC02	328
Motor Overheating		oFC03 to oFC11	328
Operation During Detection of Alarms	258, 905	oFC12 to oFC17	328
Operation During Detection of Faults (PTC Input)	258, 905	oFC50 to oFC55	328
Motor Overload		Off-Delay Timer	684
Electric Thermal Protection Operation Time	257, 904	Offset frequency	
Protection Functions	254, 901	Parameter	757
Motor parameters		oH	
Motor 2	772	Alarm Settings	940
Motor 2 Iron-Core Saturation Coefficient 1	774	Fault	328
Motor 2 Iron-Core Saturation Coefficient 2	774	Minor Fault	343
Motor 2 No-load Current	773	oH1	329
Motor 2 number of motor poles	773	oH2	343
Motor 2 rated Current	772	Alarm Settings	940
Motor 2 rated power (kW)	774	oH3	
Motor Parameters	759, 767	Fault	329
Motor 2 Iron Loss	774	Minor Fault	343
Motor 2 Leakage Inductance	773	Operation During Detection of Alarms	258, 905
Motor 2 Line-to-Line Resistance	773	oH4	329
Motor 2 Rated Slip	772	Operation During Detection of Faults (PTC Input)	258, 905
Motor parameters (induction motors)	767	oL1	329
Leakage Inductance	769	oL2	330
Line-to-Line Resistance	768	Protective function	943
Motor Iron Loss	769	oL3	
Motor Iron-Core Saturation Coefficient 1	769	Fault	331
Motor Iron-Core Saturation Coefficient 2	769	Minor Fault	343
Motor rated power (kW)	769	oL4	
No-load Current	768	Fault	331
Number of motor poles	768	Minor Fault	344
Rated current	254, 767	oL5	
Rated Slip	767	Fault	331
Motor Power Unit Selection	982	Minor Fault	344
MotorDirect@PowUpWhenUsingKeypad	985	oL7	331
Multi-step speed operation	738	On-Delay Timer	684
Setting procedure	738	Ope Select @Keypad is Disconnect	985
N		oPE01	347
Nameplate	23	oPE02	347
ND	433	oPE03	347
ndAT	358	oPE05	348
Noise filter		oPE06	349
Wiring	122	oPE07	349
Normal Duty Rating	433	oPE08	349
nSE	325	oPE09	350

oPE10	350
oPE11	350
oPE13	351
oPE15	351
oPE16	351
oPE18	351
oPE20	351
oPE33	352
Operation During Momentary Power Loss	
KEB ride-thru function	906
Operation method selection	912
Parameter	912
Speed Search function	674
oPr	332
Option card	
Parameter	780
Options	478
oS	
Detection level	783
Detection time	783
Fault	332
Minor Fault	344
Operation Select at Overspeed	781
Output Phase Loss Detection	
Protective function	942
ov	
Fault	332
Minor Fault	344
Overexcitation deceleration	
Parameter	953
Overtorque detection	
Parameter	931
P	
Panel Cut Out Dimensions	52
Parameter	
Access Level Selection	639
Automatic selection	657
Backup (drive to keypad)	166
Changing setting values	163
Checking modified parameters	170
Checking user custom parameters	164
Delete Backed-up Parameters	169
Restore (Auto Backup)	187
Restore (keypad to drive)	167
Restoring default settings	172
User-set	657
Verify (keypad and drive)	168
Parameter Setting Errors	310, 347
PASS	344
Password	
Setting	643
Verification	643
PC	
Connection procedure	106
PE1	333
PE2	333
Peripheral Devices	478
PF	333, 344
Protective function	941
PGo	
Detection time	784
Fault	333

Minor Fault	345
Operation Selection after Detection	781
PGoH	
Detection level	787
Fault	334
Level detection (PG1)	785
Level detection (PG2)	786
Minor Fault	345
Phase Order Selection	667
PID control	686
control block diagram	688
Feedback value input	687
fine tuning	689
Parameter	691
PID feedback loss detection	688
PID Sleep	689
Setpoint input	687
PM motor parameters	
d-Axis inductance	776
Encoder Z pulse offset	777
Induced voltage constant 1	776
Induced voltage constant 2	777
Motor rated current	254, 775
Motor rated power	775
Number of motor poles	775
q-Axis inductance	776
Stator resistance	776
PM Motor Parameters	774
PM Motors	
Auto-Tuning	192
Fine Adjustment	964
Motor Code Selection	775
Motor Parameters	774
Positive Temperature Coefficient (PTC) Thermistor	900
Power loss	443
Protection Functions	
DC bus undervoltage	914
Drive Overheating	940
LF2	944
Motor Overload	254, 901
oC	944
oH2	940
Overcurrent	944
Uv1	914
Protective function	
Desynchronization	948
Drive Overheating	940
GF	942
Ground Fault Detection	942
HCA	946
Input Phase Detection	941
Internal Drive Braking Transistor	947
LF	942
Low Speed Desynchronization	948
LSo	948
Motor Overheating	258, 905
Motor Overheating (PTC Input)	258, 905
oH	940
oH3	258, 905
oH4	258, 905
oL2	943
Output Current Overload	946
Output Phase Loss Detection	942

Overload	943	Set time	
PF	941	Operation	177
rr	947	Setup Wizard	
Software Current Limit Selection	943	Operation	179
Pulse Train Input		Short Circuit Braking	
Terminal RP Function Selection	892	Parameter	671
Pulse Train Input/Output		Side-by-side	
Parameter	891	Derating	945
Pulse train output		Simple Positioning Stop	751
Terminal MP function selection	894	Slip compensation	
Wiring specifications	102	Parameter	717
PWEr	358	Softcharge Relay Maintenance Set	989
R		Software Current Limit Selection	
Rating (200 V)		Protective function	943
Drive	434	Software version	
Rating (400 V)		Display procedure	186
Drive	436	Speed Agreement	
rdEr	359	Parameter	927
Ready		Speed Detection	
LED status	141	Parameter	927
Remove		Speed Estimation Speed Search	676
Front cover	46	Speed limit	
Keypad	39	Parameter	752
Terminal cover	46	Speed Search function	
RESET key	135	Operation during momentary power loss	912
Restore		Parameter	674
Parameters (Auto Backup)	187	Stall Prevention function	
Parameters (keypad to drive)	167	Parameter	917
Reverse Operation Selection	664	Stationary Auto-Tuning	
rF	334	Induction Motor	191
rH	334	PM Motors	192
RJ-45 connector	135	Precautions	198
Rotational Auto-Tuning		Stationary Auto-Tuning for Line-to-Line Resistance	191
Induction Motor	191	Precautions	199
PM Motors	192	Stator resistance Auto-Tuning	192
Precautions	198	Precautions	199
rr	334	STo	345
Protective function	947	SToF	345
rUn	345	Stop command	
RUN		LOCAL/REMOTE Run selection	660
LED status	141	STOP key	135
Run command		STOP Key Function Selection	983
LOCAL/REMOTE Run selection	660	Stopping Method Selection	661
Switching between LOCAL/REMOTE	660	STPo	335
Run Command at Power Up	670	Surge protective device	
Run Command Selection 2		Connection	121
Switching between LOCAL/REMOTE	669	SvE	335
RUN indicator	135, 138	T	
RUN key	135	Temperature	
S		Environment	34
S-curve characteristics		Terminal block	96
Parameter	716	Configuration of main circuit terminal block	65
Sampling time setting		Control circuit terminal block functions	93
Data log	184	I/O terminals function selection switches	101
SC	334	Terminal function selection	103
SCF	335	Terminal A1	101, 103
SE	345	Terminal A2	101, 103
SEr	335	Terminal A3	101, 104
Serial communication terminals		Terminal AM	101, 104
MEMOBUS/Modbus Communications	96	Terminal FM	101, 104
Set date and time		Termination resistor	
Operation	177	Setting switch	105

Test run	
Checklist	209
Fine tuning	202
Procedure	143
Procedure for no-load test run	200
Procedure for test run with actual load	200
Thermal overload relay	
Connection	118
Tightening torque	
Control circuit terminals	97
Main circuit terminals	71
TiM	
Fault	335
Minor Fault	346
Timer function	
Parameter	684
Torque compensation	
Parameter	752
Torque Compensation	
Parameter	722
Torque Control	
Parameter	751
Switching to/from Speed Control	754
Torque limit function	
Parameter	937
Torque reference	
Parameter	752
Trend Plot	
Monitors	158
Troubleshooting	
Code Displayed	311
No Code Displayed	362
Troubleshooting without Fault Display	362
TrPC	346
Tuning	711
U	
U2, U3 Initialization	990
UL3	
Fault	335
Minor Fault	346
UL4	
Fault	336
Minor Fault	346
UL5	
Fault	336
Minor Fault	346
Undertorque detection	
Parameter	931
Unit of measurement setting	
Acceleration and deceleration times	714
Unit selector	982
Up 2 command	
Parameter	746, 751
Up command	830–831
Parameter	746, 751
USB port	135
Connecting a PC	106
User Monitor Select afterPowerUp	976
User Parameter Default Value	983
User-Set Display Units Max Value	978
User-SetDisplayUnits Dec Display	978
Uv	346

Speed Search Selection at Start	683
Uv1	336
Detection level settings	914
Uv2	336
Uv3	336
V	
vAEr	359
V/f Pattern	759
Second Motor	770
V/f Pattern Display Unit	977
Verify	
Parameters (keypad and drive)	168
vFyE	359
Vibration-resistant	34
W	
WEED	430
Wire gauge	
Control circuit terminals	97
Main circuit terminals	71
Voltage drop	71
Wiring	117
AC reactor	120
Braking Resistor	108
Checklist	128
Control circuit terminal block	98
Control circuit terminals	92
DC link choke	120
Main circuit terminal block	86
Main circuit terminals	65
MEMOBUS/Modbus	272
Motor	65
Noise filter	122
Thermal overload relay	118
Wiring distance	
Drive and motor	82
Z	
Z pulse Auto-Tuning	192
Zero Servo function	
Parameter	709

Revision History

Date of Publication	Revision Number	Section	Revised Content
June 2019	1	All	Revision: Reviewed and corrected entire documentation
		1, 2, 5, 8, 10, 12	Addition: Protection design added along with corresponding data. <ul style="list-style-type: none">• IP55/UL Type 12 Heatsink External Mounting
January 2019	–	–	First Edition

GA800 Drive

Technical Reference

YASKAWA AMERICA, INC.

2121, Norman Drive South, Waukegan, IL
60085, U.S.A.

+1-800-YASKAWA (927-5292)

<http://www.yaskawa.com>

DRIVE CENTER (INVERTER PLANT)

2-13-1, Nishimiyaichi, Yukuhashi,
Fukuoka, 824-8511, Japan

Phone: +81-930-25-2548

<http://www.yaskawa.co.jp>

YASKAWA EUROPE GmbH

Hauptstr. 185, 65760 Eschborn,
Germany

Phone: +49-6196-569-300

E-mail: support@yaskawa.eu.com

<http://www.yaskawa.eu.com>

YASKAWA ELÉTRICO DO BRASIL LTDA.

777, Avenida Piraporinha, Diadema, São
Paulo, 09950-000, Brasil

Phone: +55-11-3585-1100

<http://www.yaskawa.com.br>

In the event that the end user of this product is to be the military and said product is to be employed in any weapons systems or the manufacture thereof, the export will fall under the relevant regulations as stipulated in the Foreign Exchange and Foreign Trade Regulations. Therefore, be sure to follow all procedures and submit all relevant documentation according to any and all rules, regulations and laws that may apply.

Specifications are subject to change without notice for ongoing product modifications and improvements.

Original instructions.

© 2019 YASKAWA Electric Corporation

YASKAWA ELECTRIC CORPORATION



SIEPC71061737

SIEPC71061737

Revision: B <1>-0

June 2019

Published in Japan

18-11-20_YAI

YASKAWA